

PERFECTLY MINDFUL ORIGAMI

THE ART AND CRAFT OF
GEOMETRIC ORIGAMI



Photography
by Brent Darby

Mark Bolitho

CONTENTS

Mindful Origami	6	TWISTS AND TURNS	54	ADVANCED MODULARS	102
Getting Started	7	Twister	56	Equilateral Module	104
Fortune Teller	10	DNA wheel	60	Harlequin Module	110
		Flexagon One	64	Flower Ball	113
ONE-PIECE PROJECTS	12	Flexagon Two	69	Vertex Module	118
Tetrahedron	14	Twist Star	72	Starburst	123
Cube	18	Diamond Wreath	76	Resources and Acknowledgements	128
Hexahedron	20				
Octahedron One	25	MODULAR PROJECTS	80		
Octahedron Two	28	Crystal	83		
Sunken Pyramid	32	Octahedron Nolid	86		
Diamond	37	Dodecahedron	89		
Geo Ball	40	Truncated Cube	94		
Icosahedron	46	Hexahedron	98		
Pyramid	51				

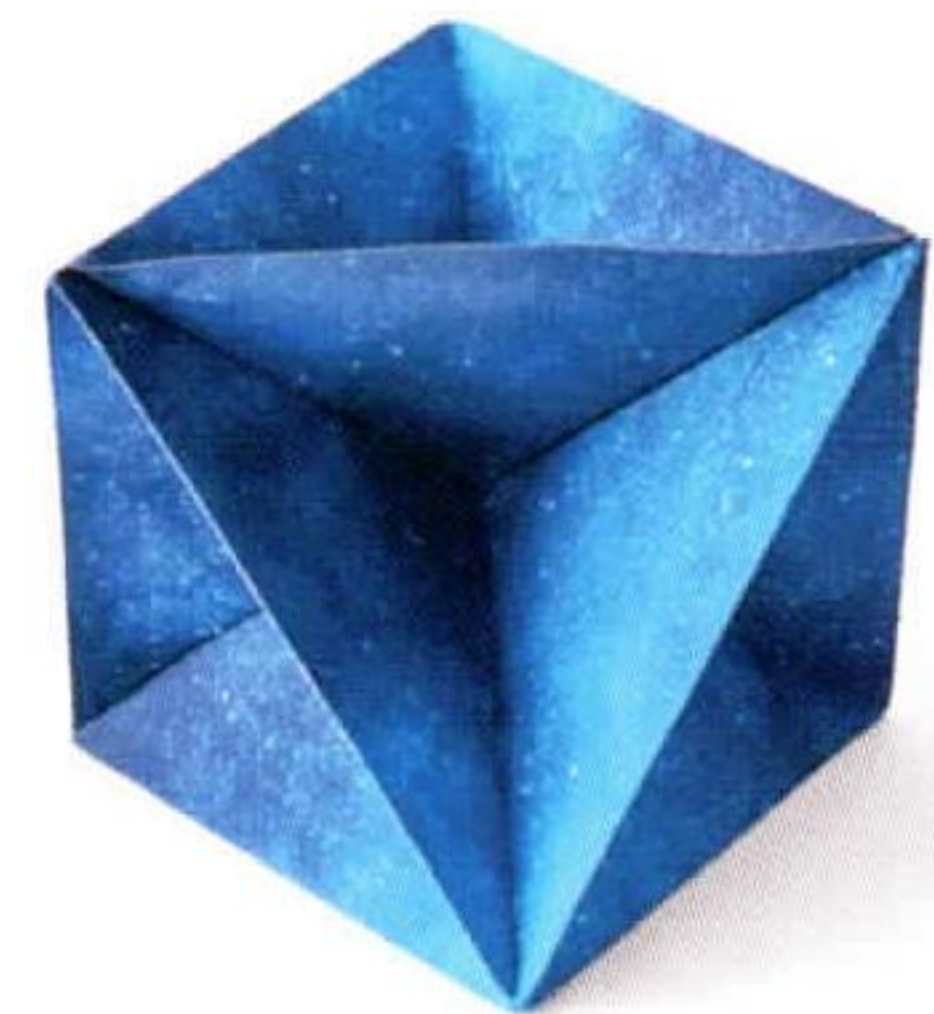
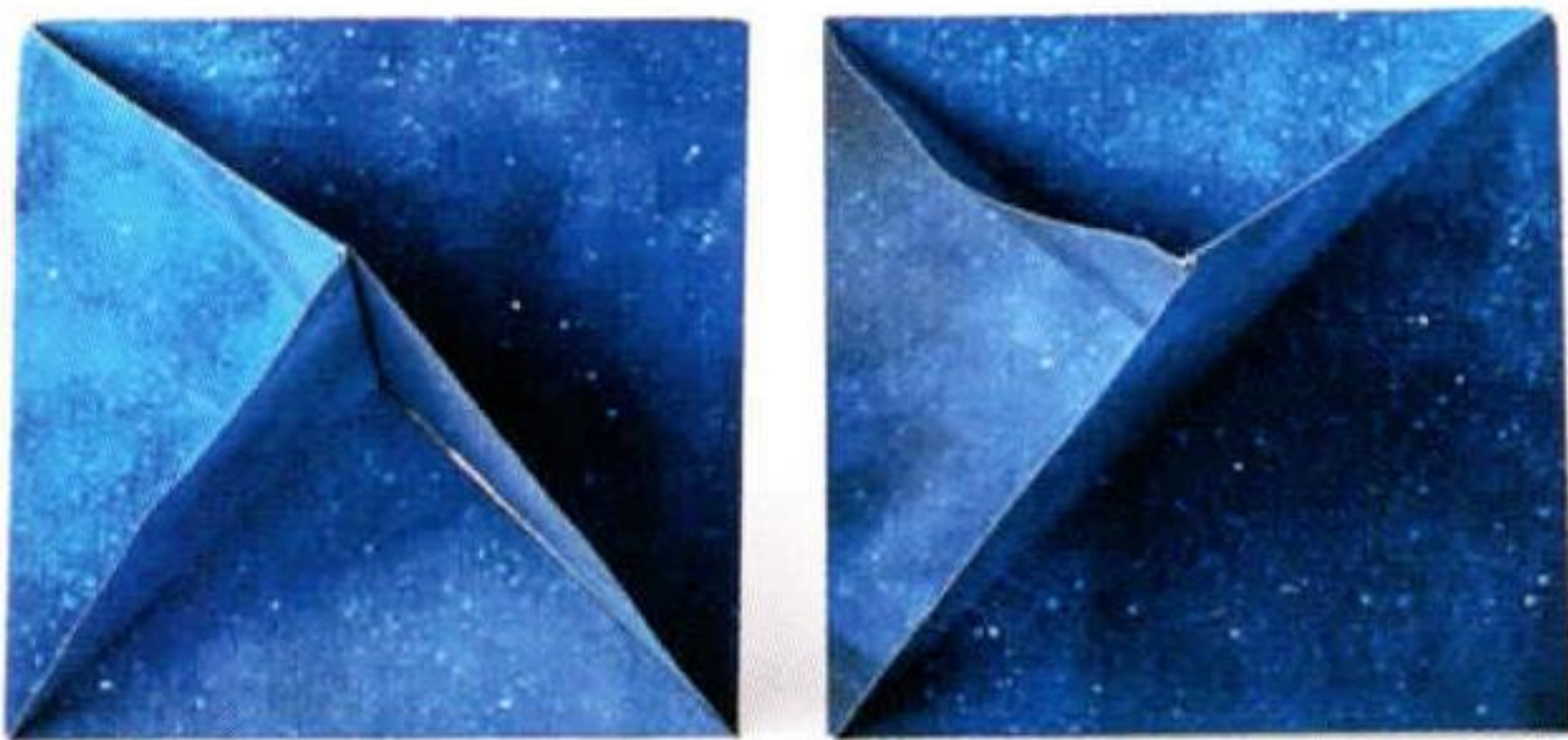

At the start of the collection I have included instructions for the Fortune Teller. This is an opportunity to gain familiarity with the diagrams and symbols used to explain the folding sequences. Some models are more complex than others and we have given a rating to each project as a guide (see page 4).

If you are new to origami, try starting with the easier models and working up to more complex projects. I hope you enjoy folding these projects as much as I enjoyed designing them.

GETTING STARTED

Here are the basic folding techniques and symbols you'll need to complete the projects in the book.

FOLDING IN HALF

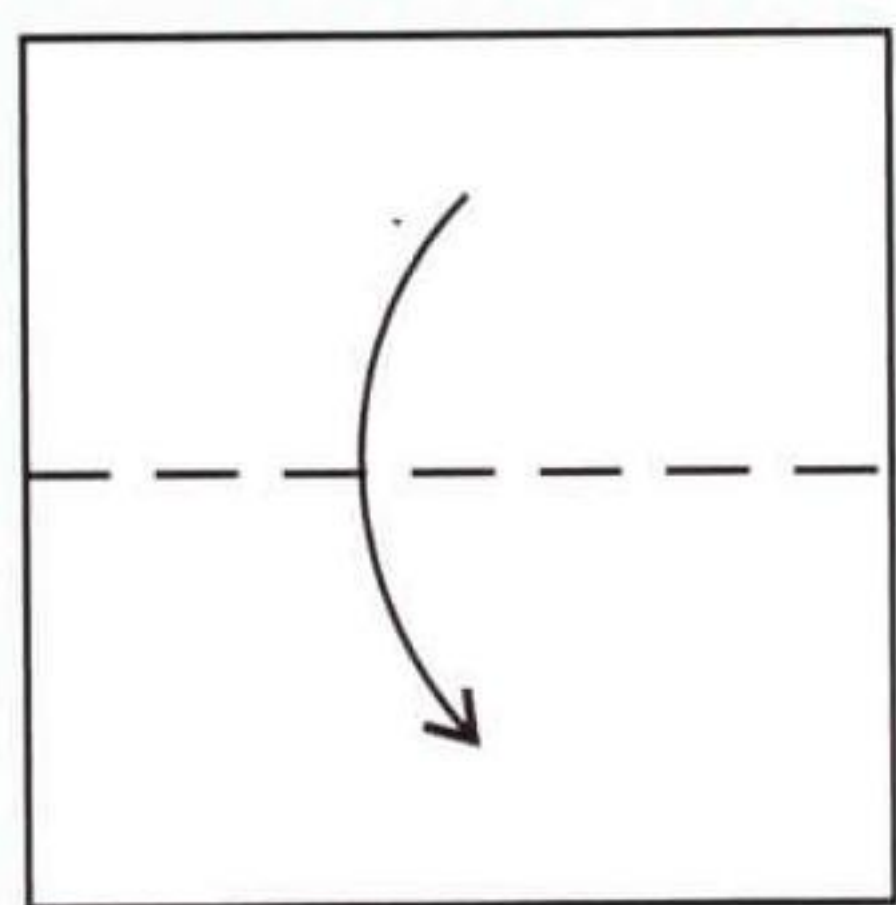

1 The step indicates that the paper should be folded in half.

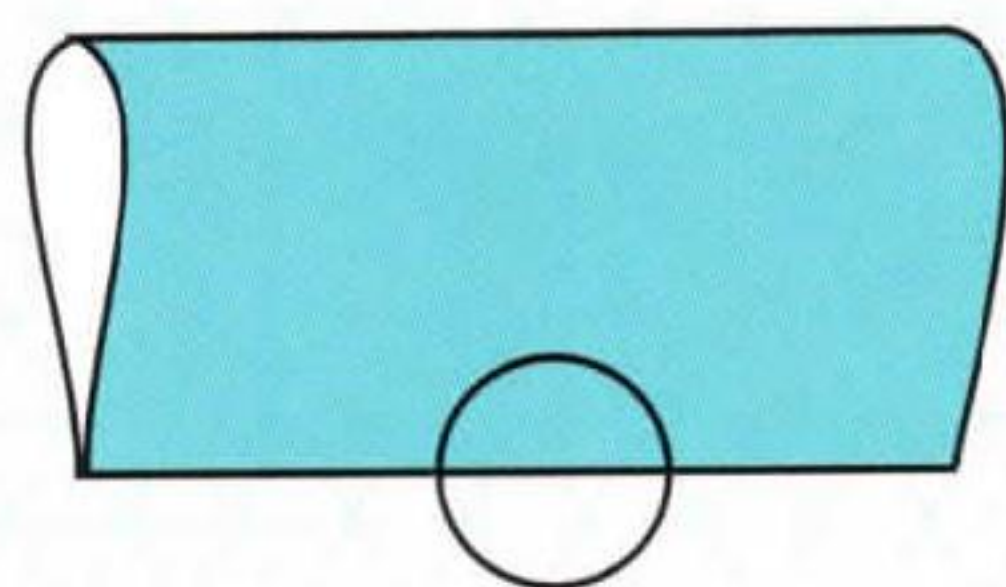

2 First of all, line up the opposite sides of the paper and hold the edges together.

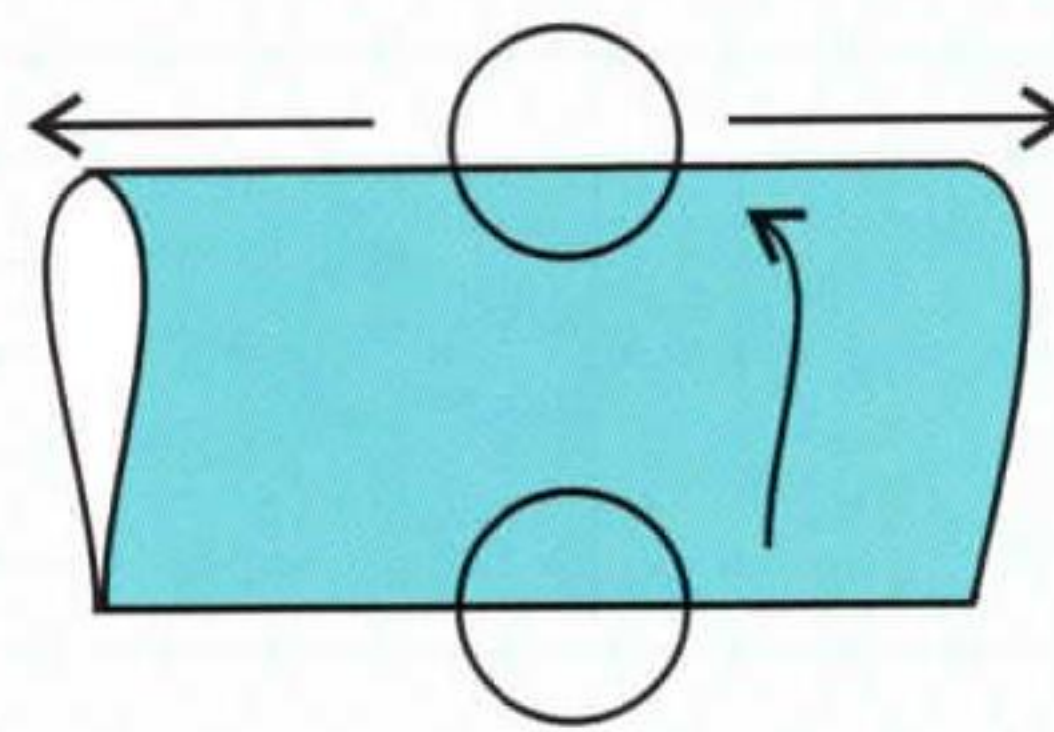

3 When the two layers are aligned, pinch the middle together. Then make the crease.

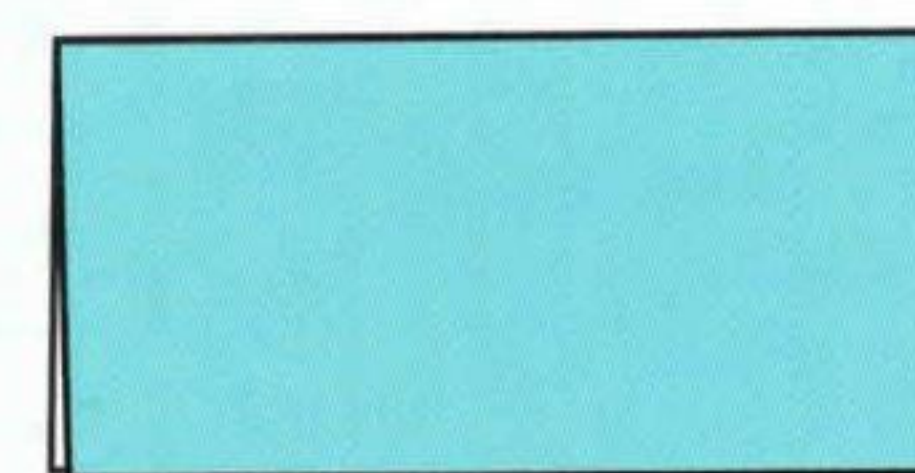

4 The paper is accurately folded in half.

ARROWS AND FOLDS



Paper-folding instructions explain the folding process with a series of steps leading to a finished model. Each step explains one or two folds in the process. Steps should be followed in order and when a step is completed, it should resemble the image shown in the next step.

The transition from one step to the next is shown by a series of lines and arrows indicating where folds should be made. The lines show where to fold and the arrows show how the paper should be moved to make folds.

Folds are described as either Mountain Folds or Valley Folds.

These names refer to how the surface will look after the fold has been completed. A Mountain Fold will fold towards the observer, forming a mountain shape, while a Valley Fold will fold away, forming a V or valley shape. They are represented by differing dotted-line symbols.

ARROWS

-  Fold
-  Fold and unfold
- [2]  Fold over 2 layers

FOLDS

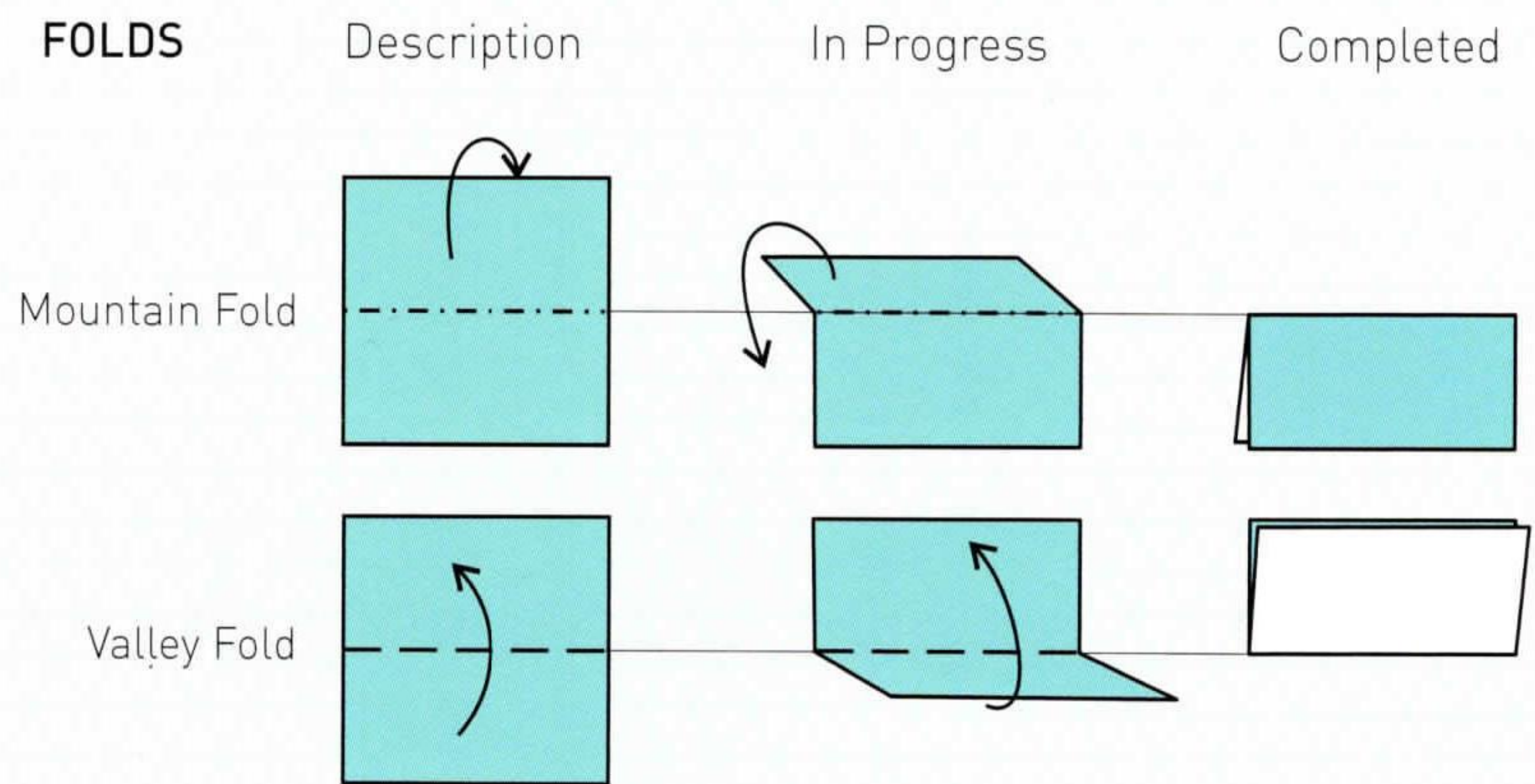

ORIGAMI SYMBOLS

Various symbols are used to explain the folding process, such as turning the model over, rotating the model or repeating a step. The symbols on the right are the ones used in this book.

Follow the instructions in numerical order. After completing the folds in any step, look ahead; the model you have should look like the diagram in the next step. If not, undo the folds and try again. Each step is self-contained, with additional information in the caption below each diagram.

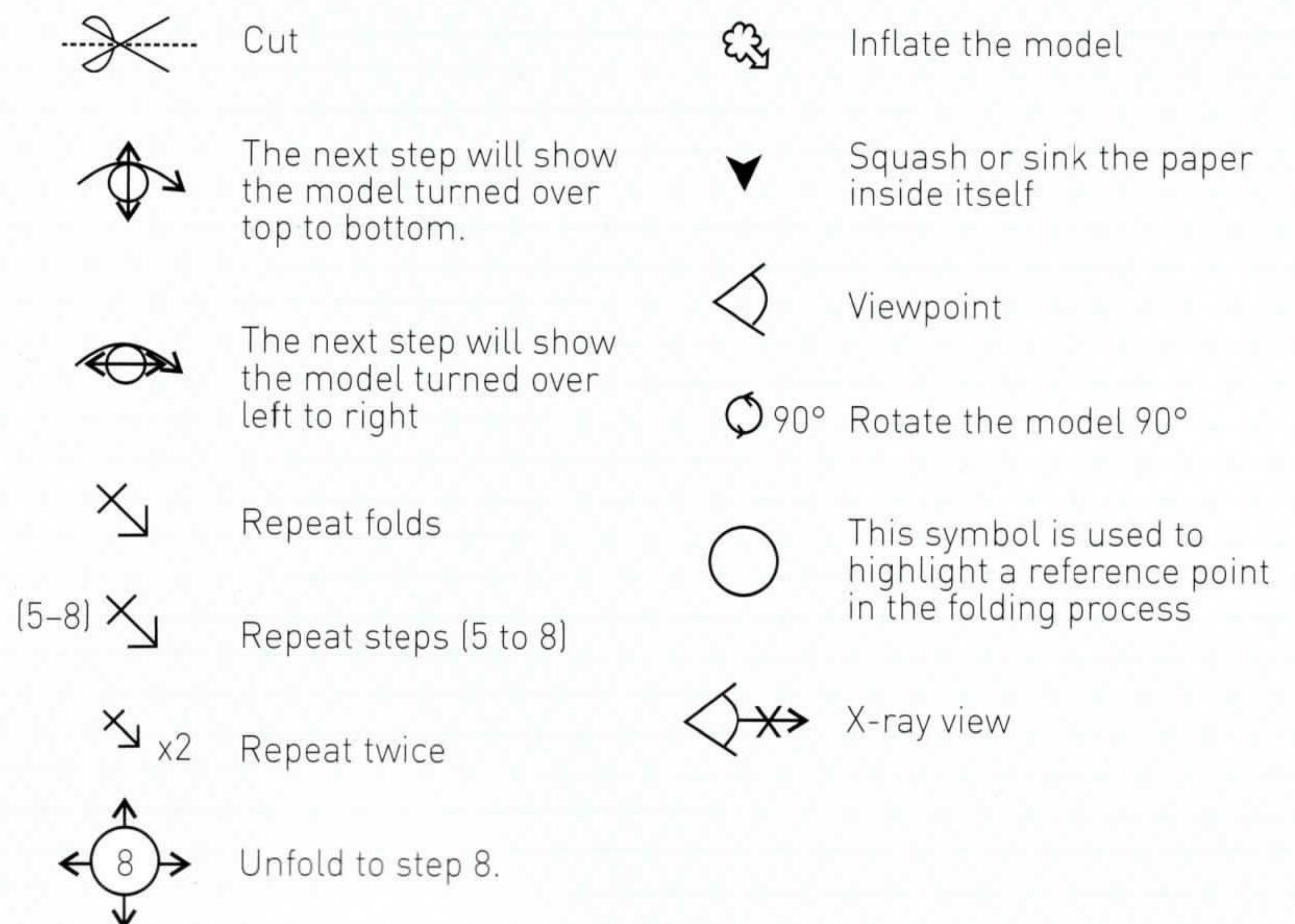

DIAGRAMS

The diagrams are shown in two colours, with the coloured side being the front and the white side being the reverse. This should make the step-by-step instructions easier to follow.

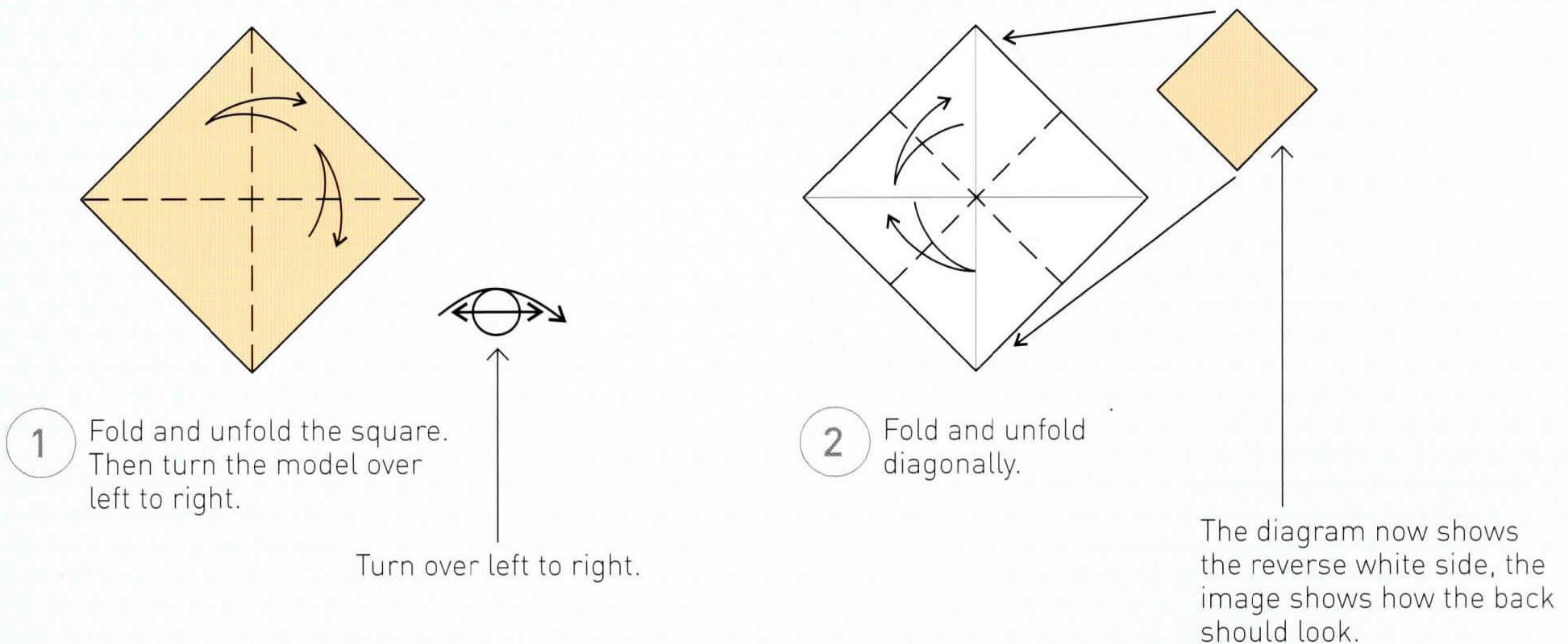

THE FOLLOWING IS A LONGER SEQUENCE TO MAKE A PRELIMINARY BASE.

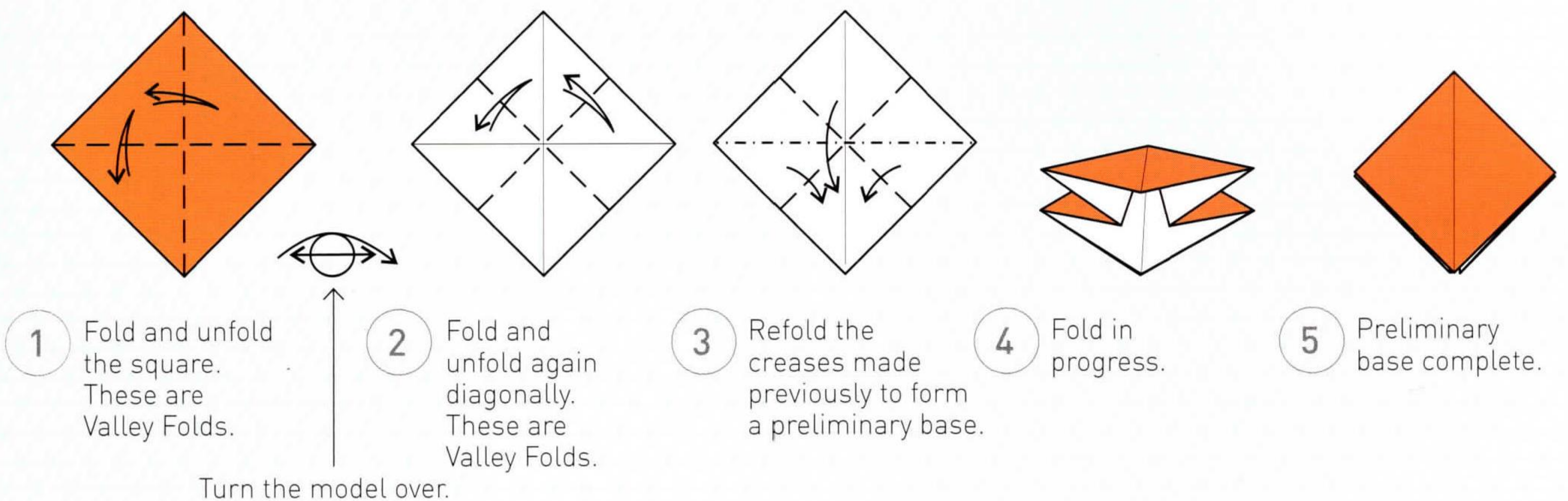

Origami instructions take you through a step-by-step process from start to finish. Symbols are included to explain the transition from one step to the next. Each step shows how the folded project should look and shows the folds that should be applied

to progress to the next step.

When approaching a step, do look ahead to the next diagram to see how the model should look when the fold has been applied. Then check and make sure that the paper model you are making resembles the step diagram.

Look out for reference points to compare your model with the instructions to make sure you remain on the right track.

If your model doesn't resemble the step you are on, unfold the last step and work back until it does.

Fortune Teller

*

The classic fortune teller is an introductory model included to enable familiarization with the diagrams and symbols used. The * indicates that this is an easy model.

18 X 18CM (7 X 7IN)

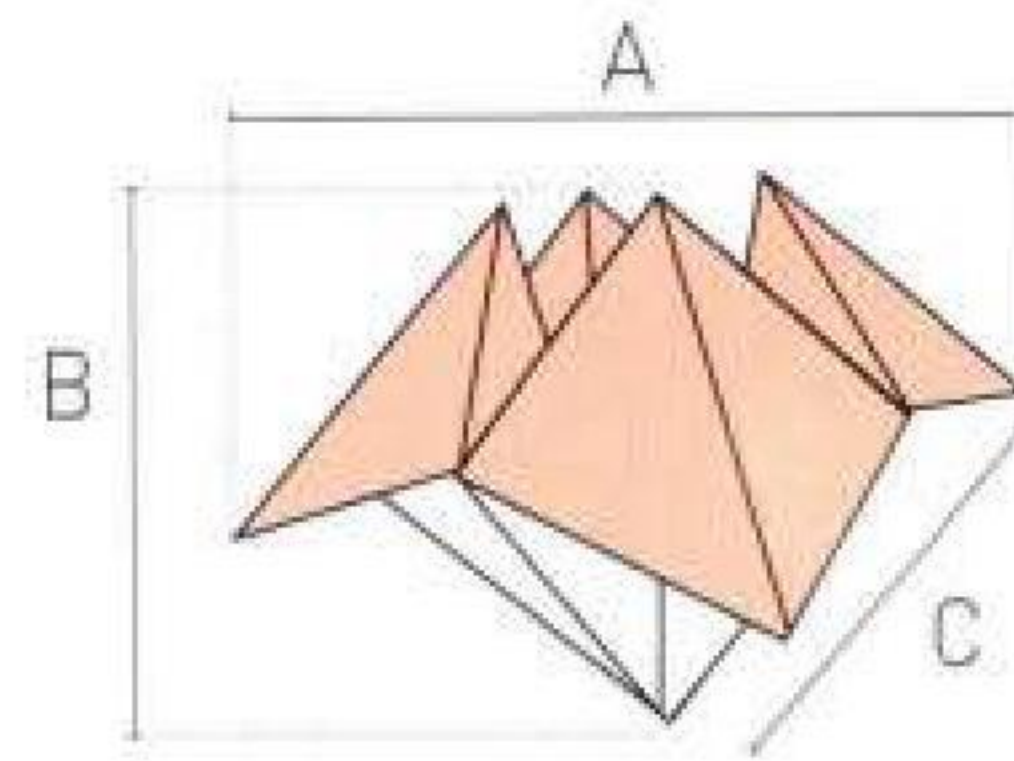
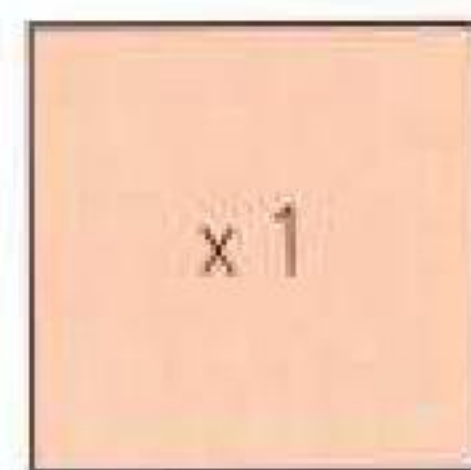

A	12.6cm	(5in)
B	5.4cm	(2in)
C	12.6cm	(5in)

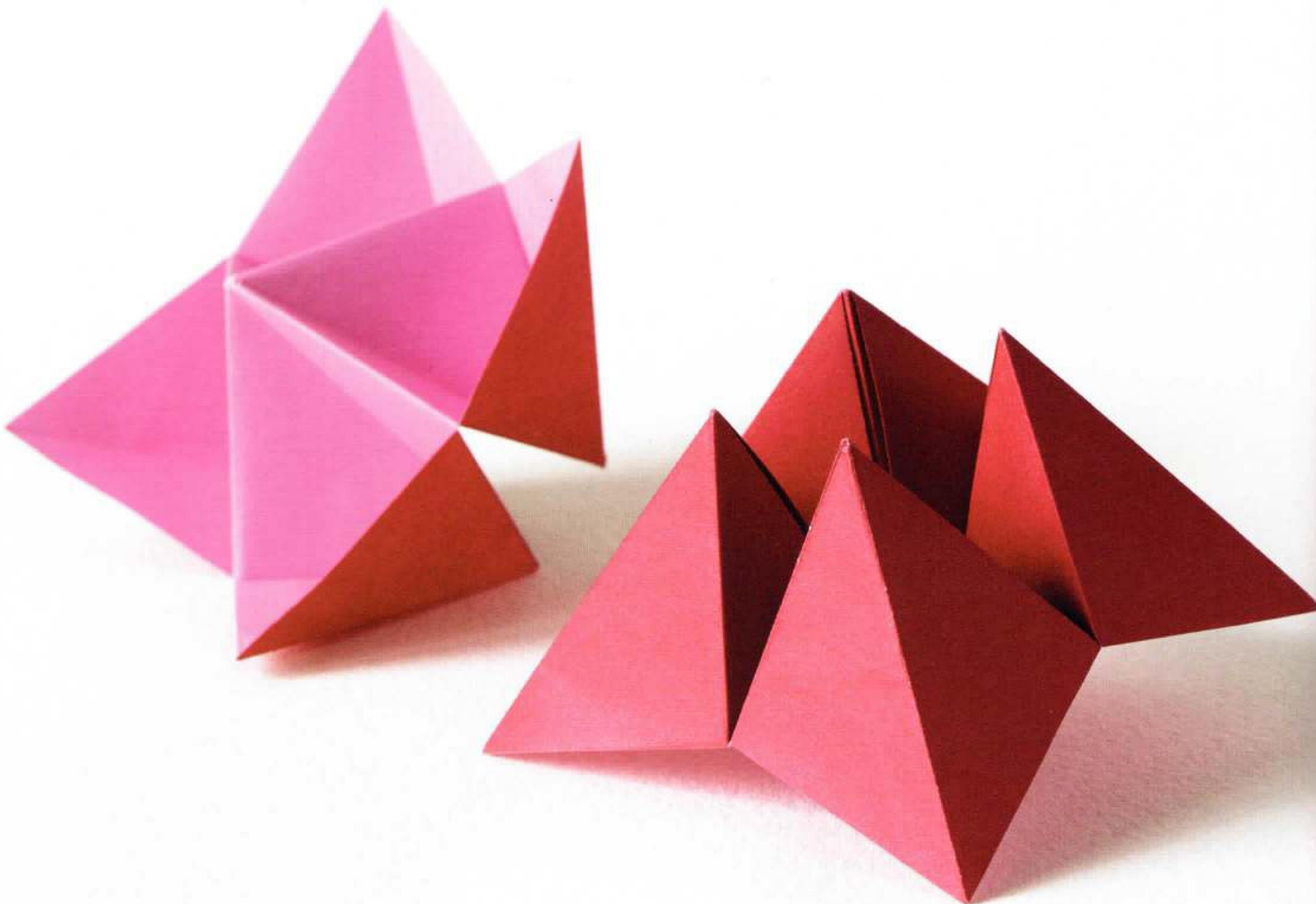

START WITH A SQUARE, COLOURED SIDE UP.

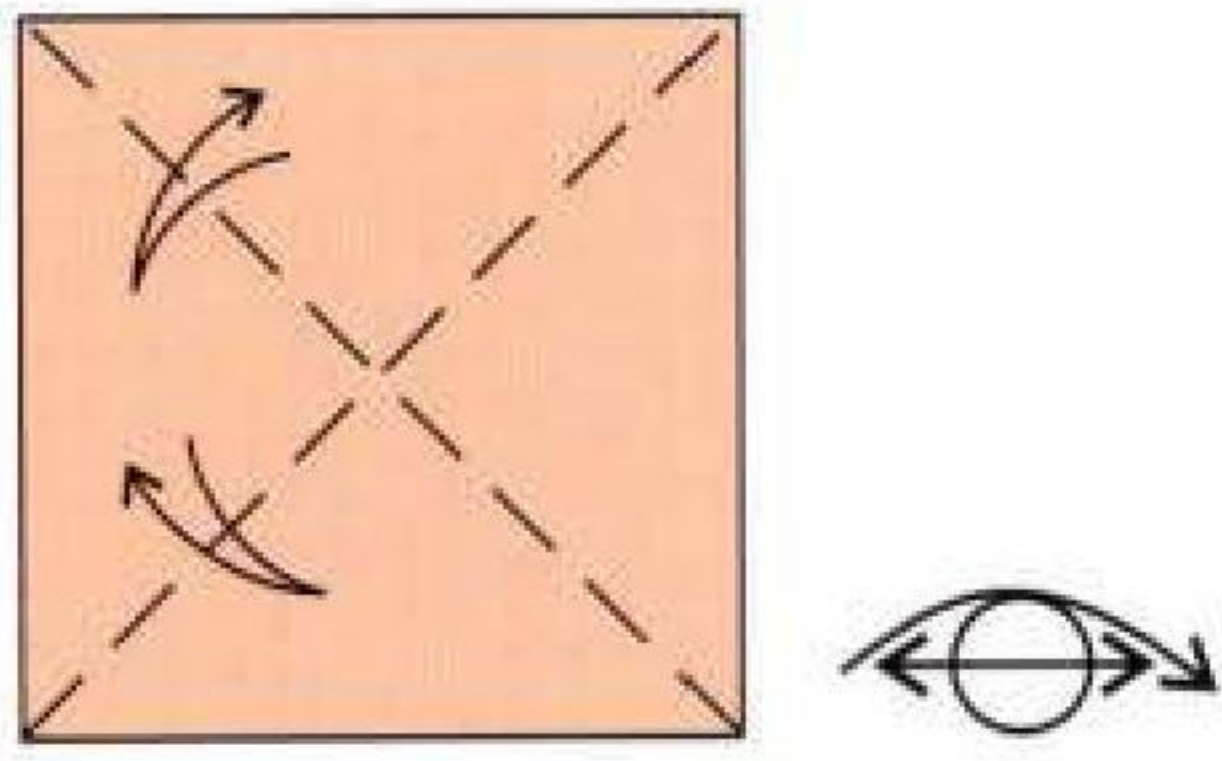

- 1 Fold and unfold the square in half diagonally. Then turn the model over left to right.

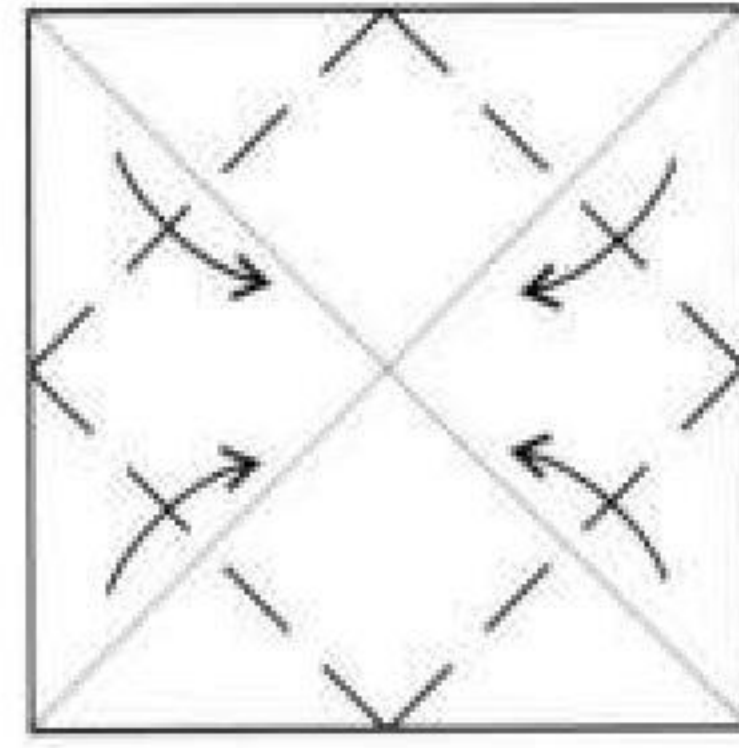

- 2 Fold the corners in to the middle.

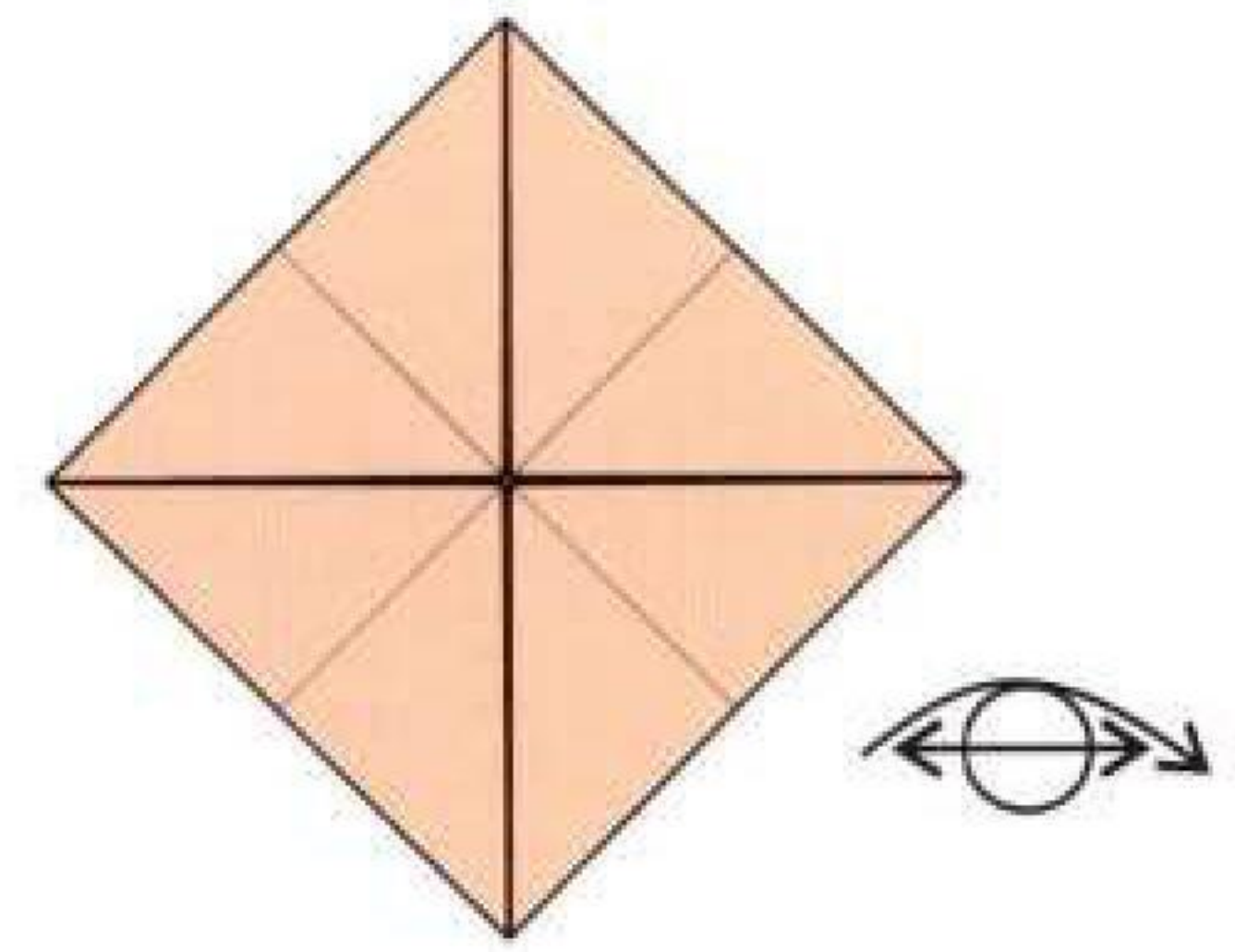

- 3 Turn the model over left to right.

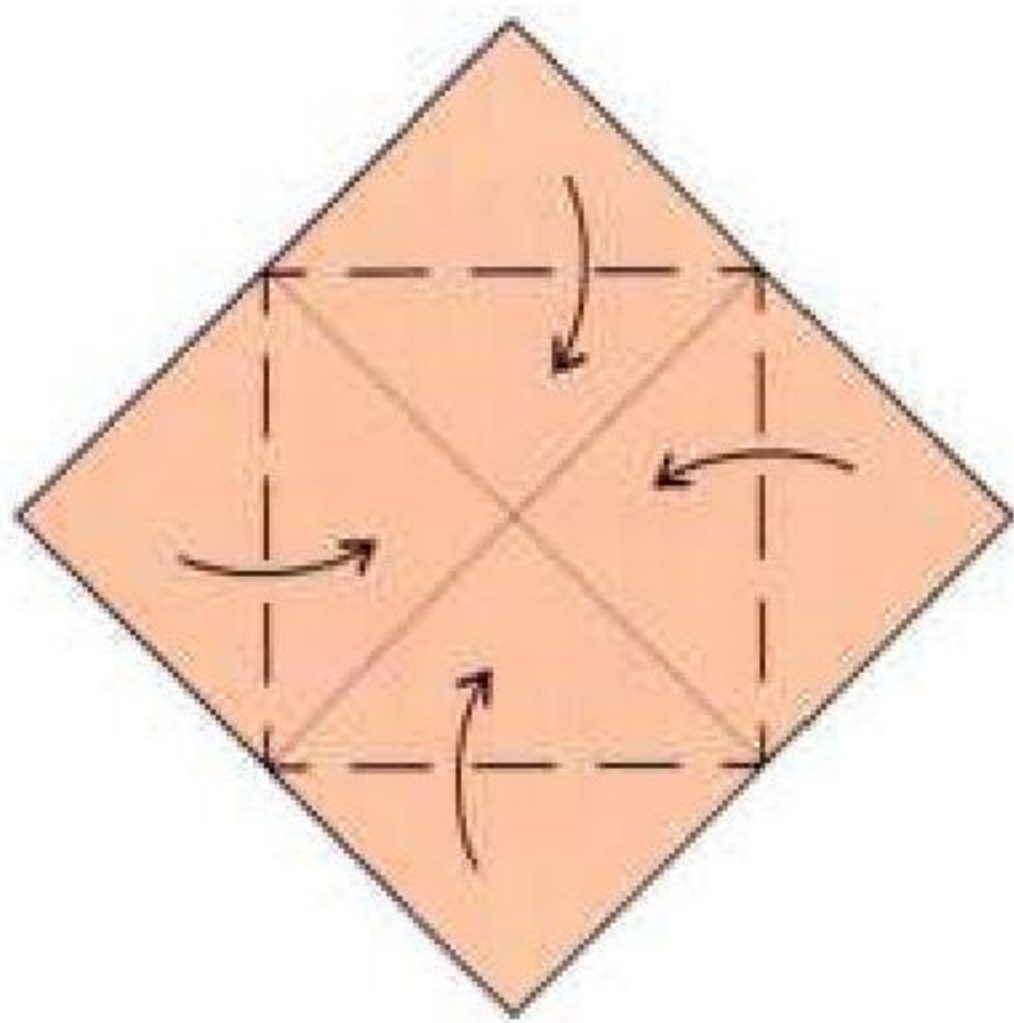

- 4 Fold the corners in to the middle.

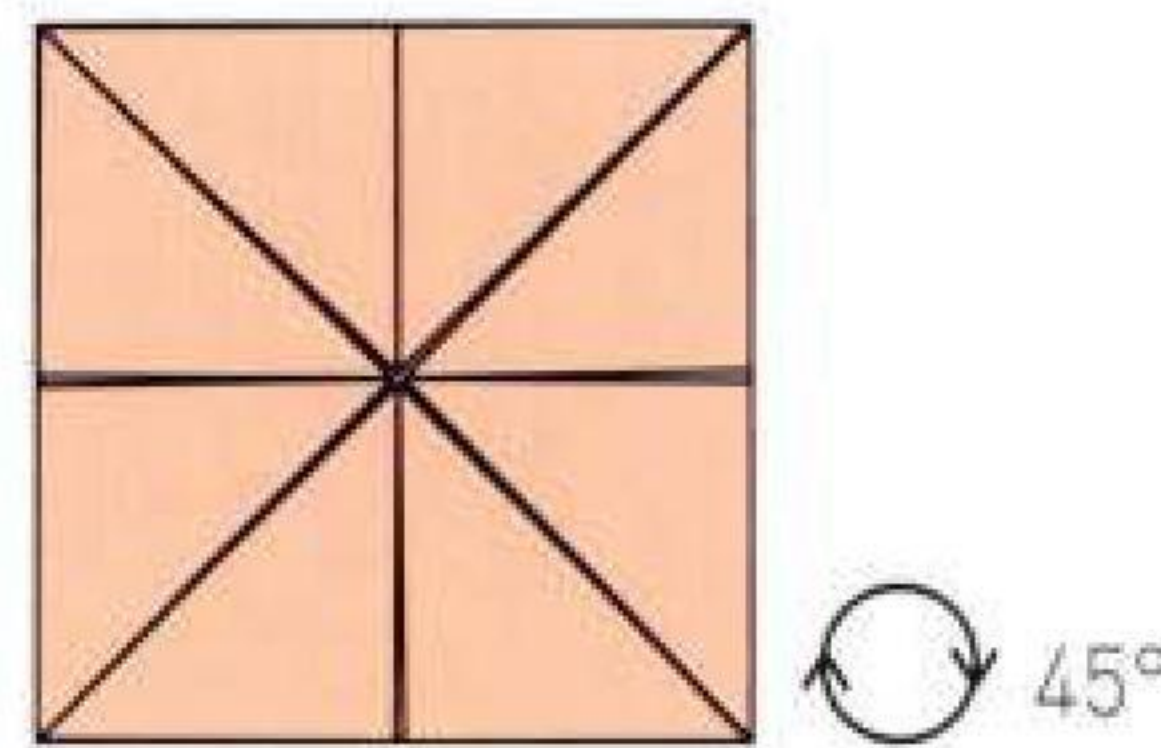

- 5 Rotate the model by 45°.

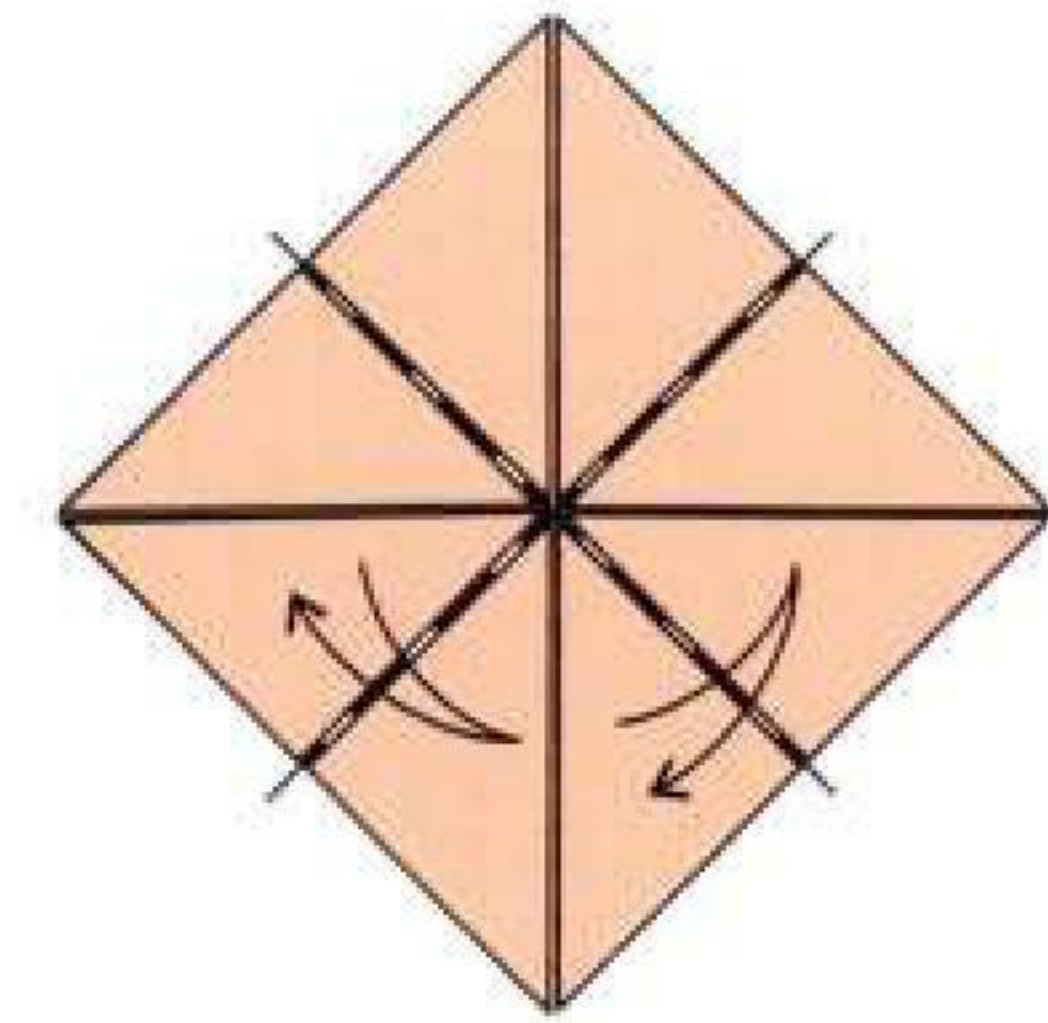

- 6 Fold and unfold along the diagonals as shown.

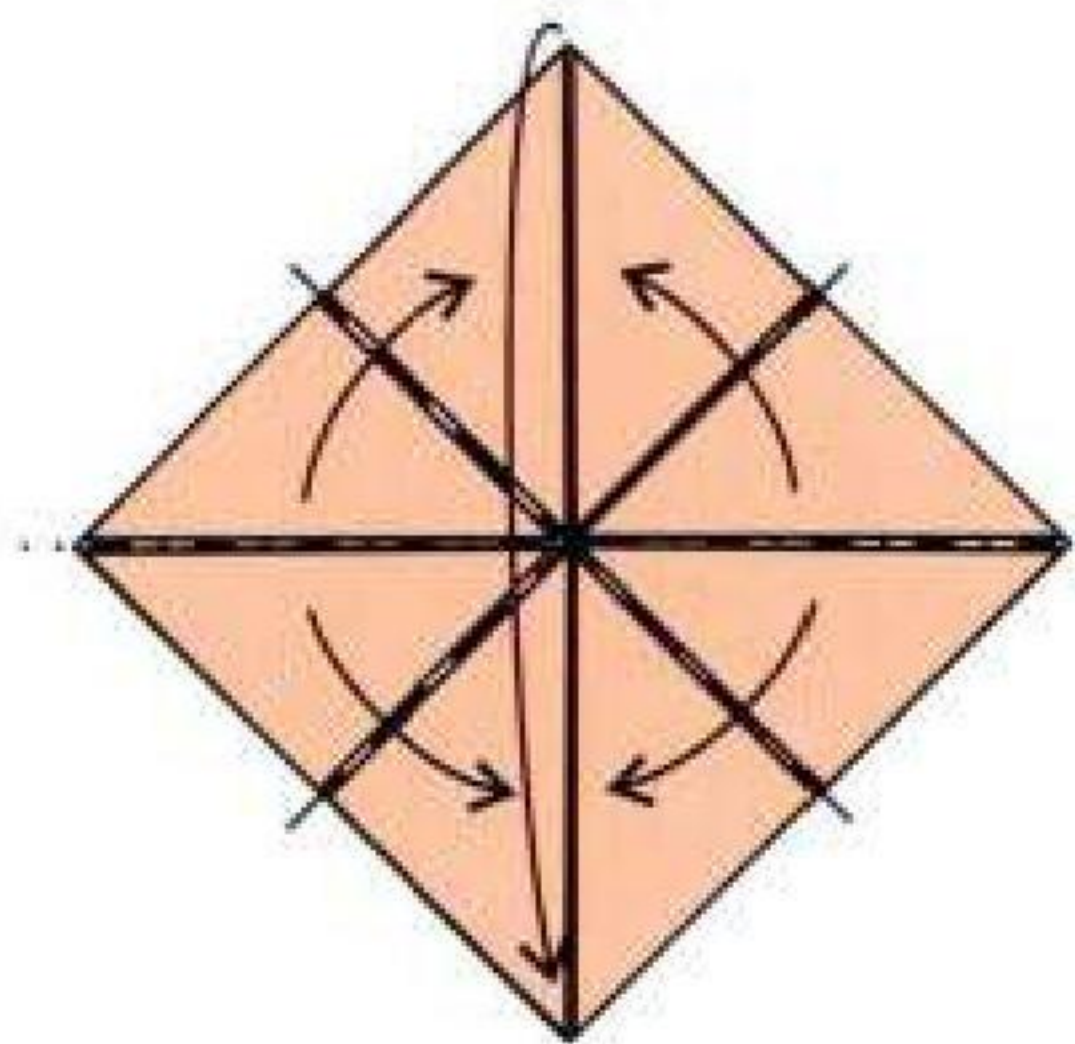

- 7 Fold the upper section down. At the same time, fold in the corners and make a preliminary base shape.

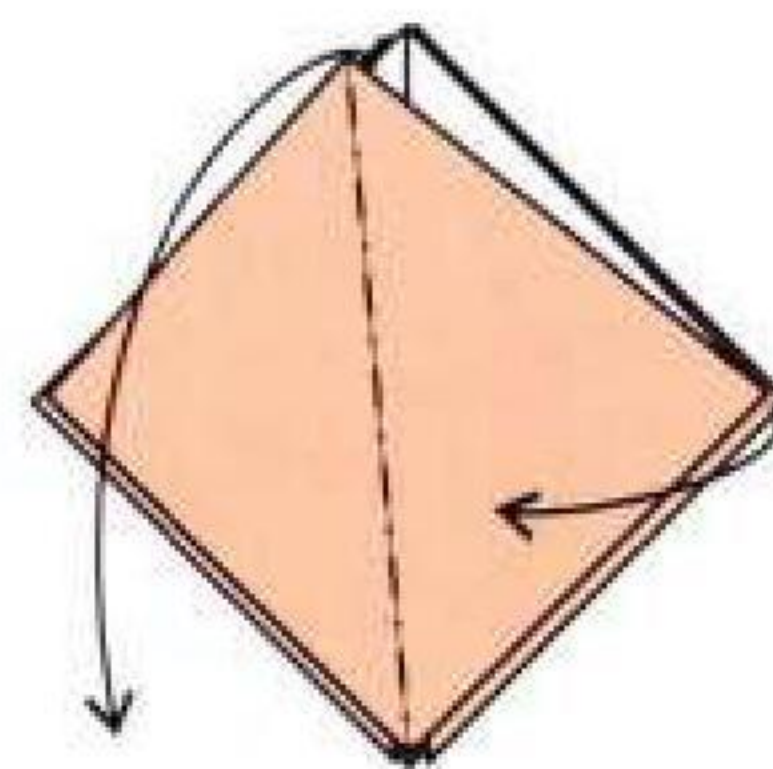

- 8 Fold one side over and fold out the upper layer.

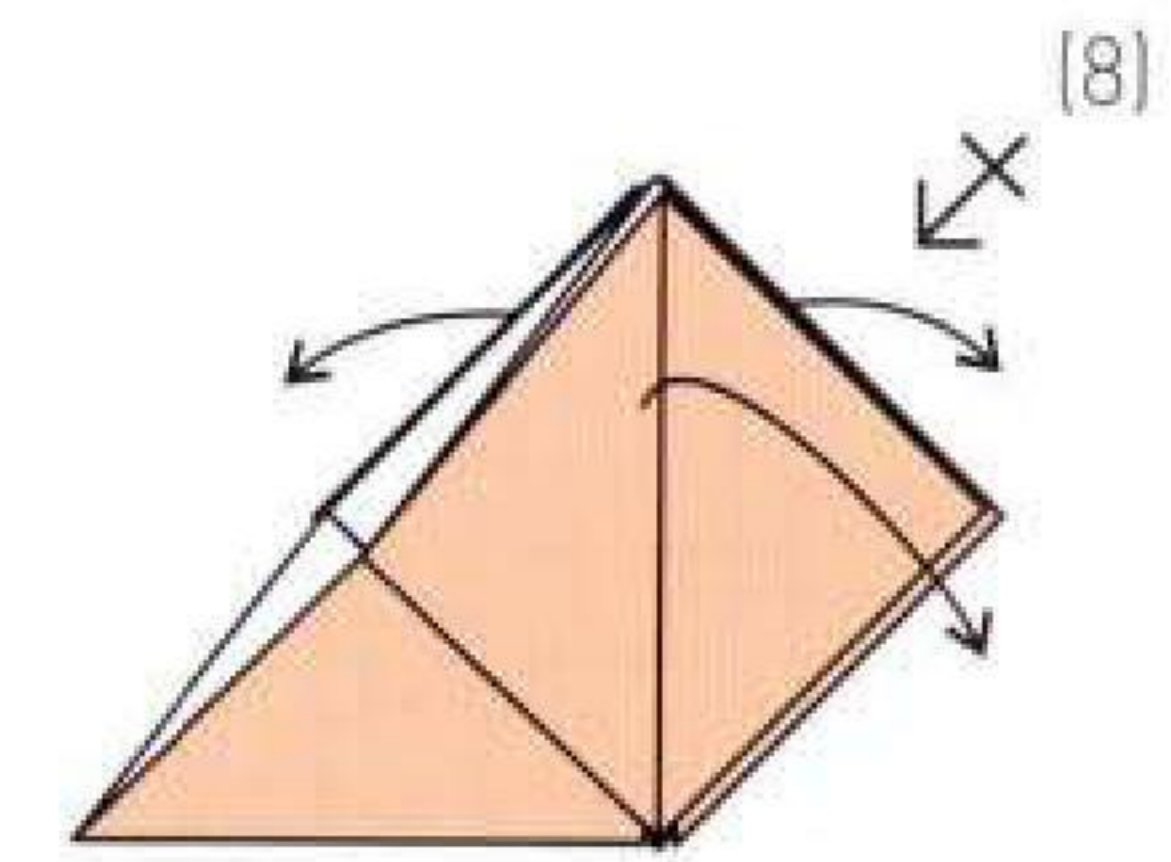

- 9 Repeat Step 8 on the other three sides.

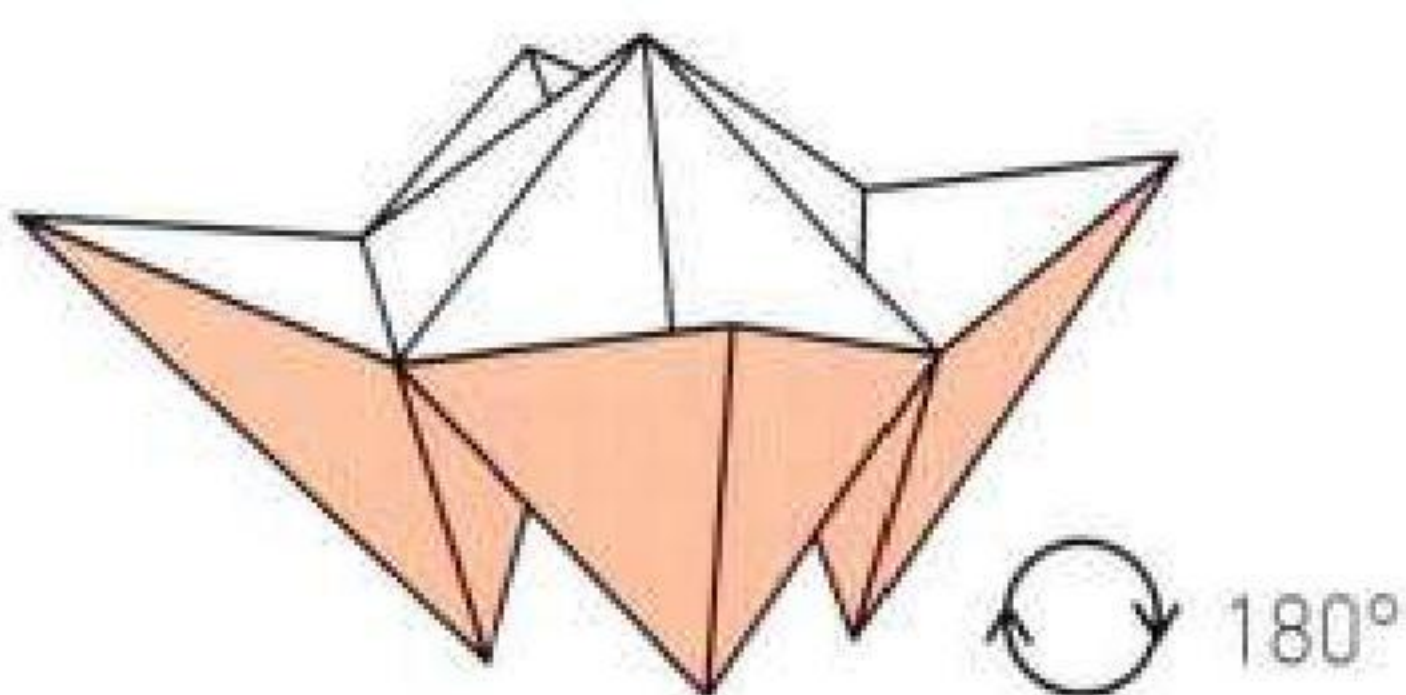

- 10 Rotate the model 180° top to bottom.

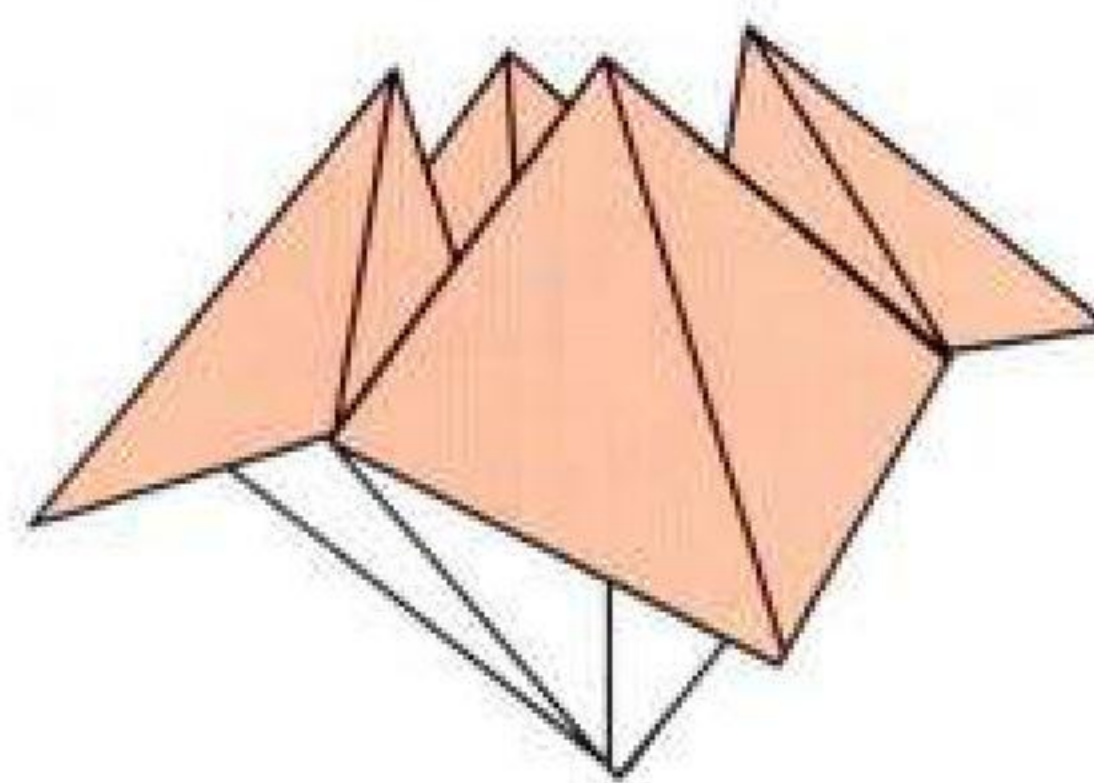

- 11 Complete.

ONE-PIECE PROJECTS

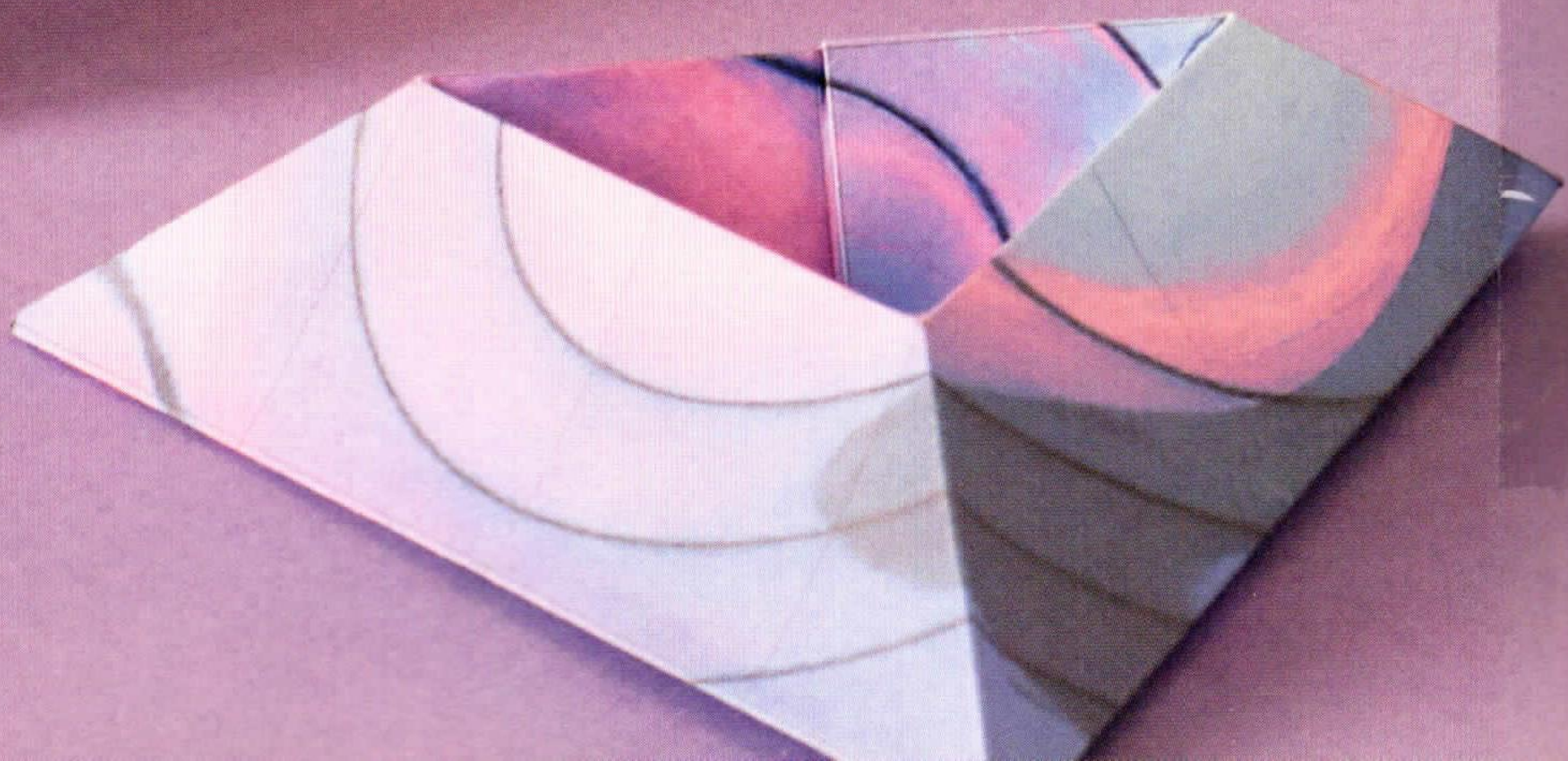
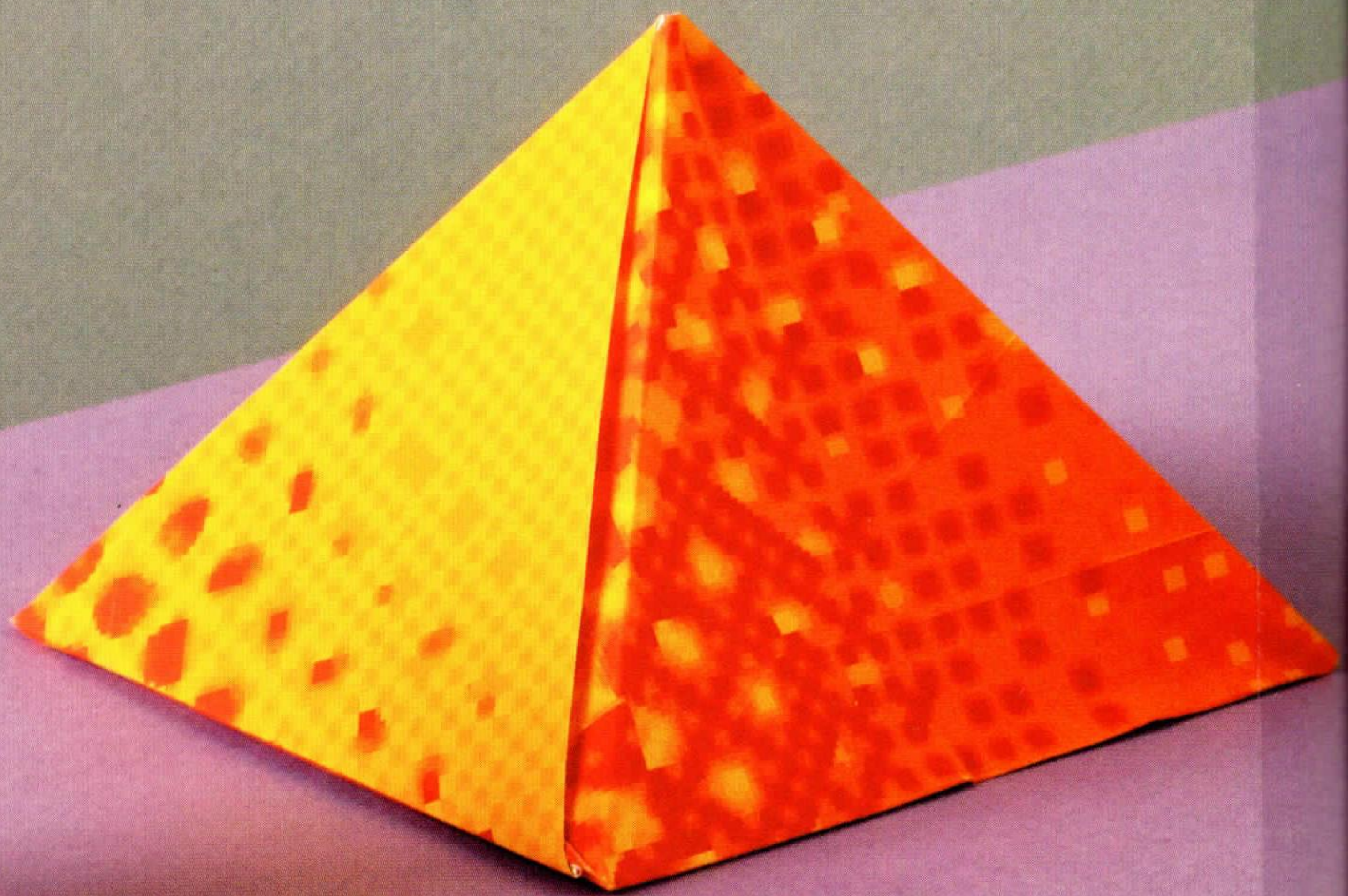
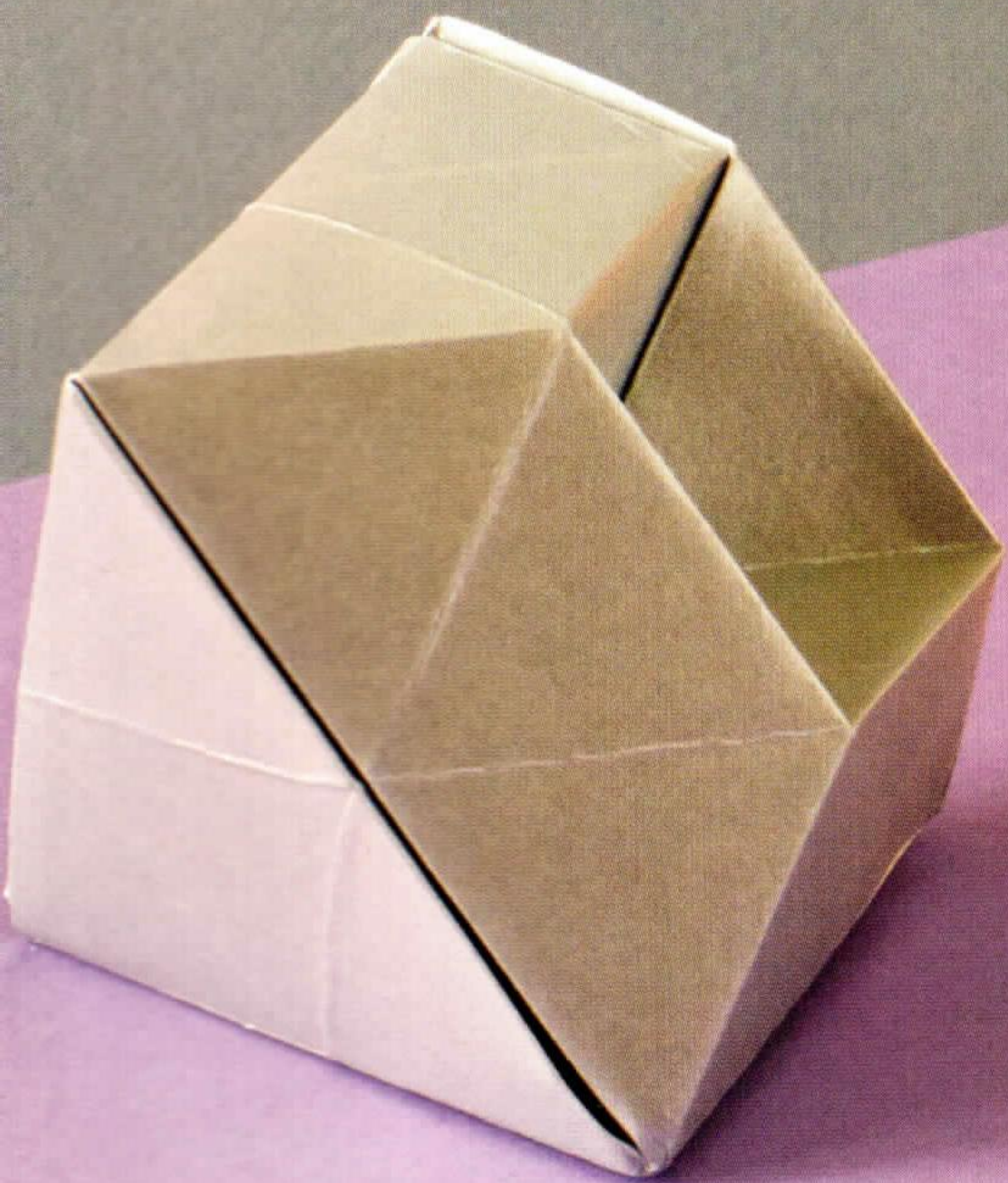

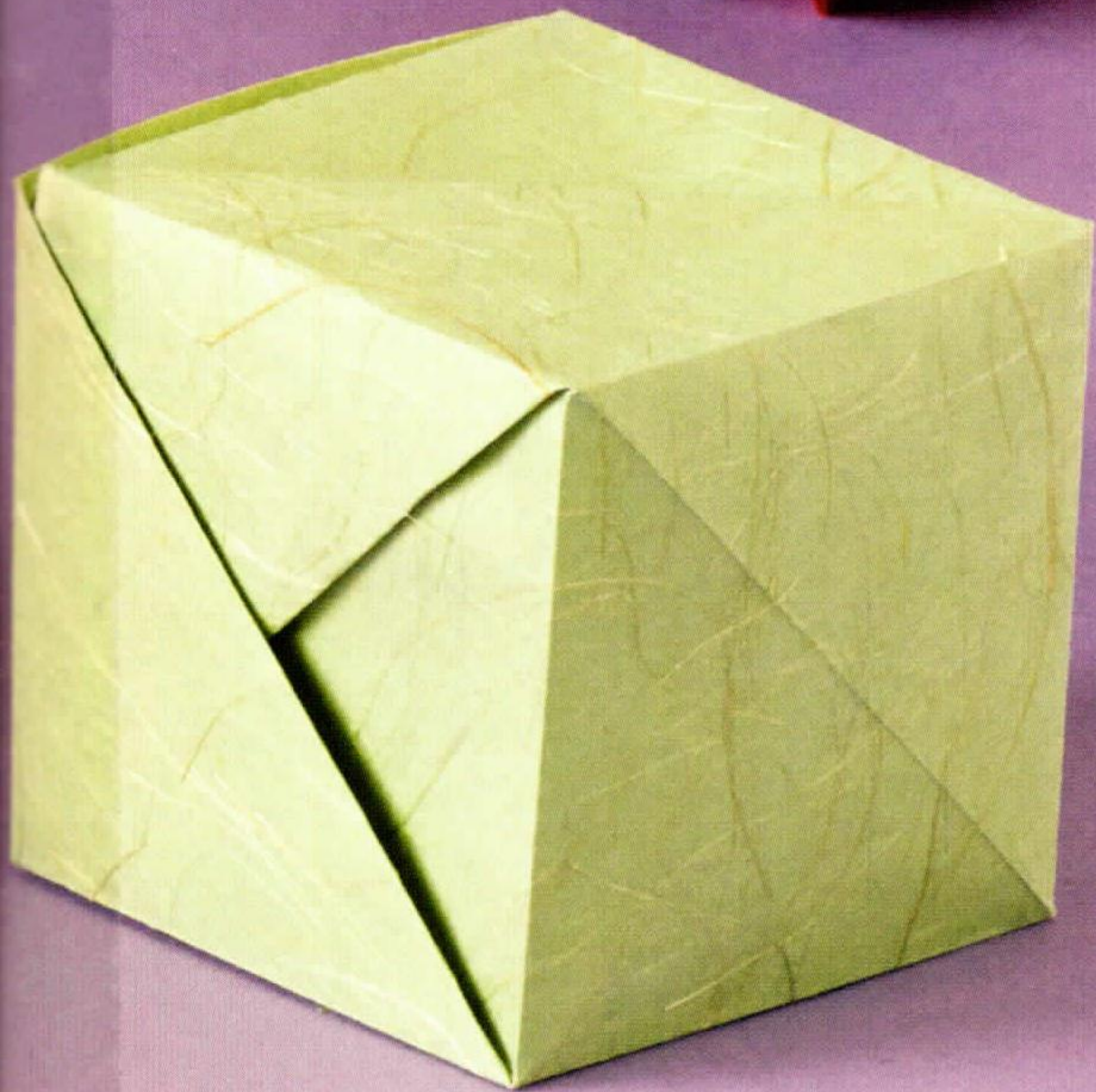
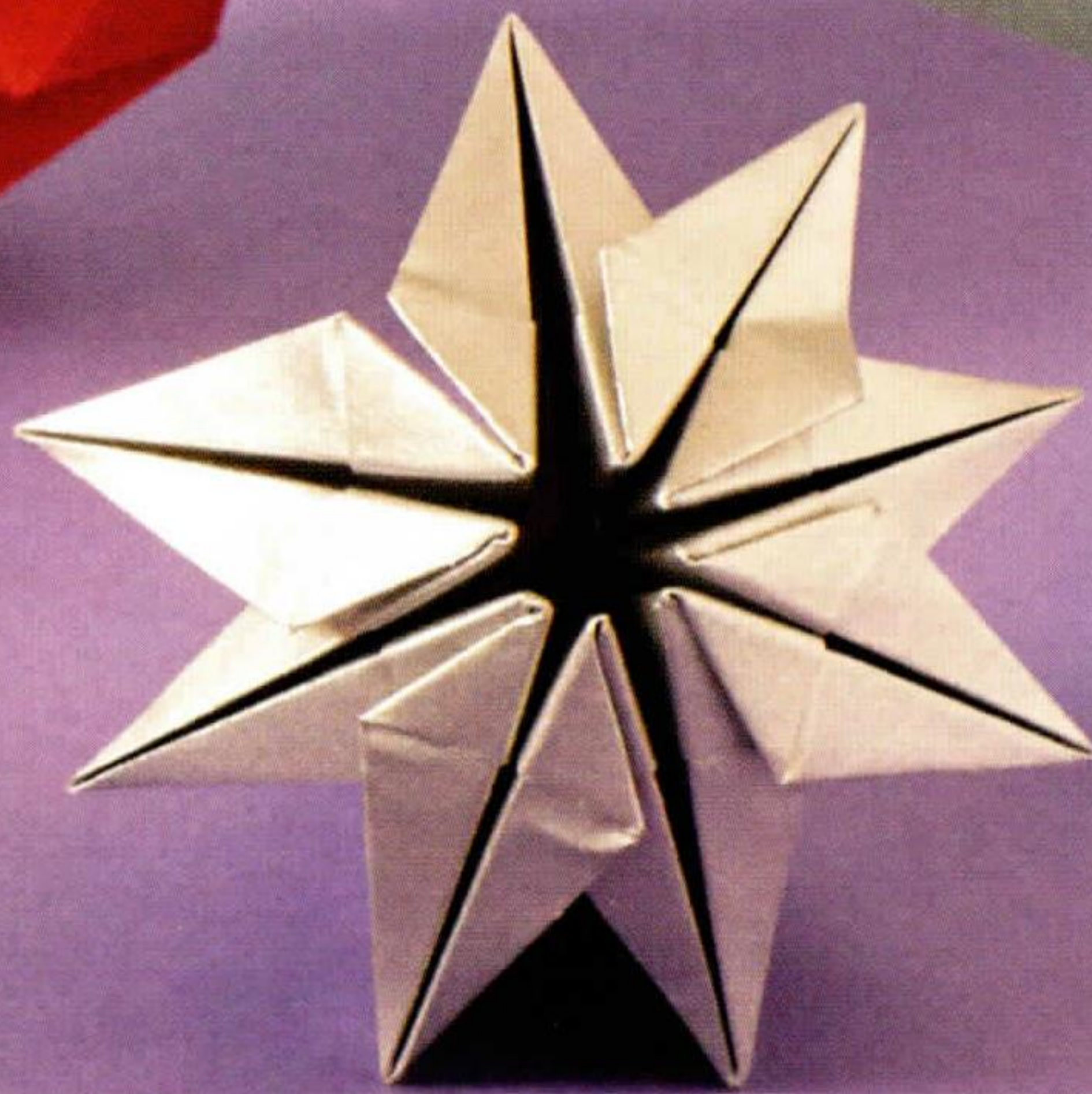
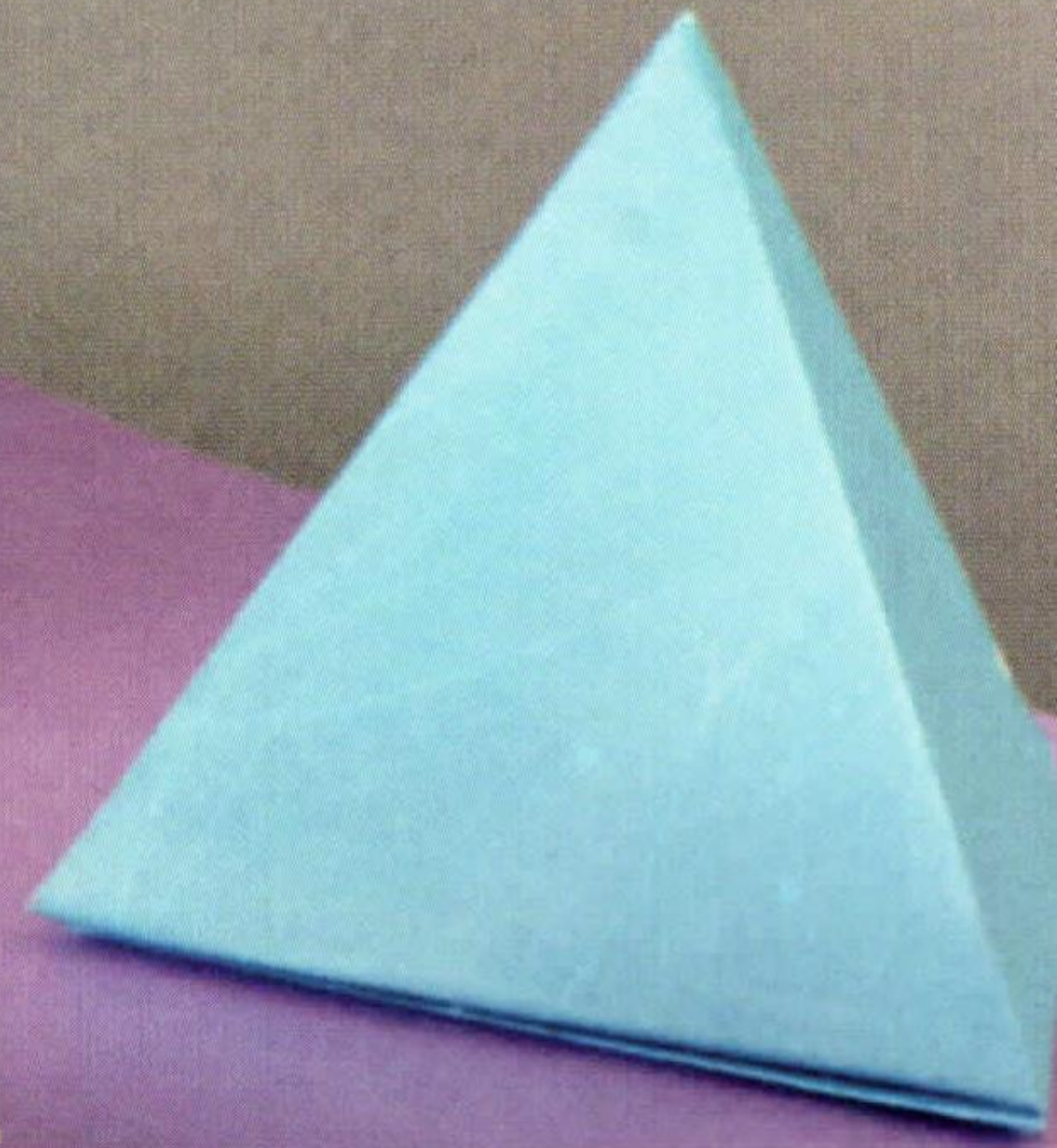
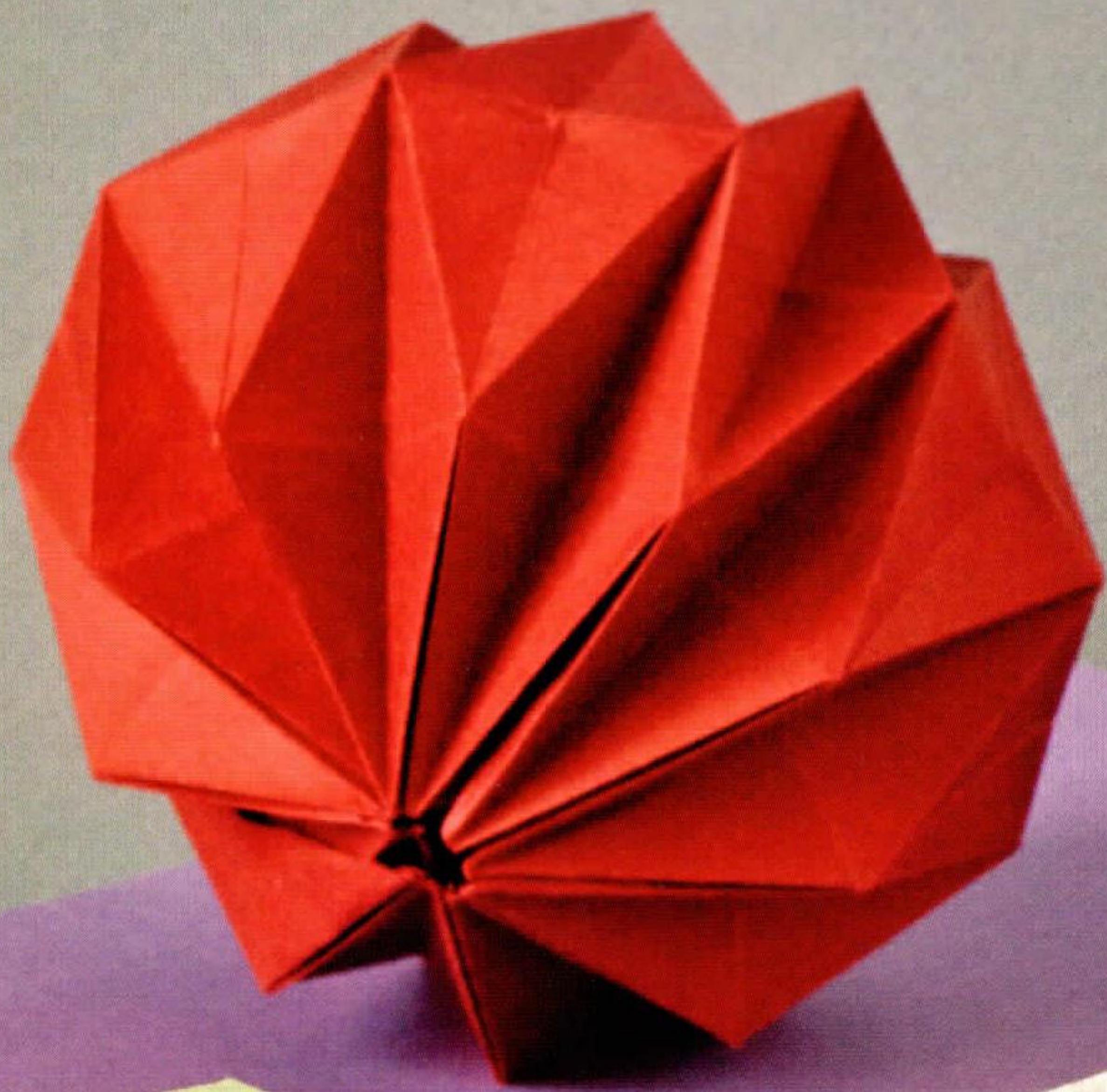

Tetrahedron



The tetrahedron is formed by dividing the paper into three, then folding four equilateral triangles to become the faces of the assembled tetrahedron.

The final look is subtle but holds firm. The tetrahedron is the first of the platonic solids and in early writings is associated with fire.

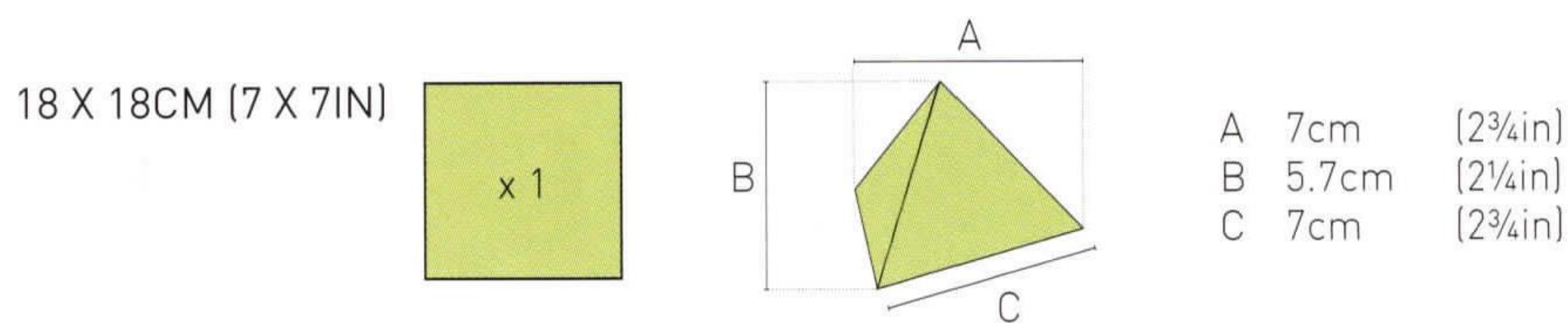

START WITH A SQUARE, COLOURED SIDE UP.

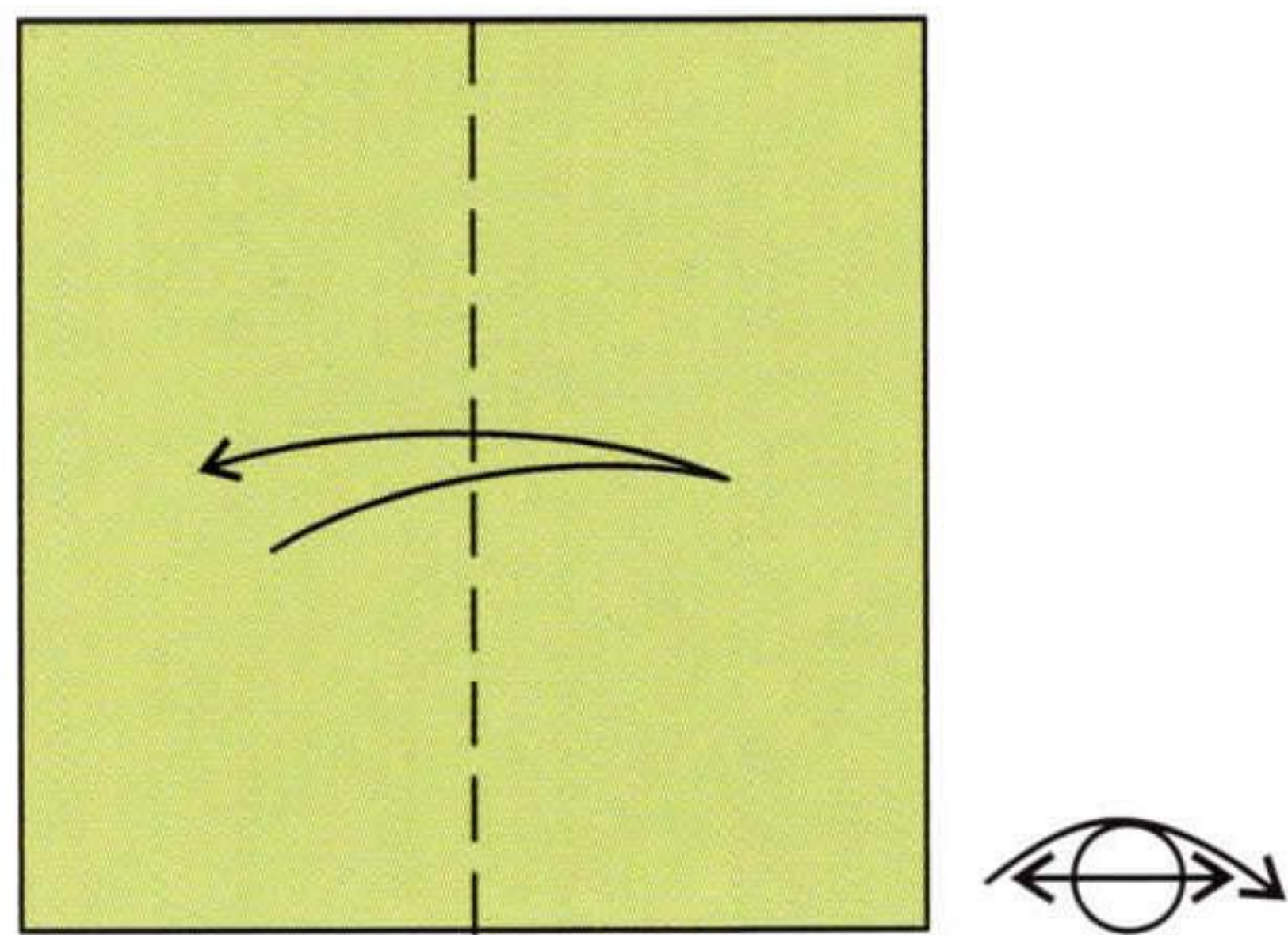

- 1 Fold and unfold the square in half lengthwise. Then turn the model over left to right.

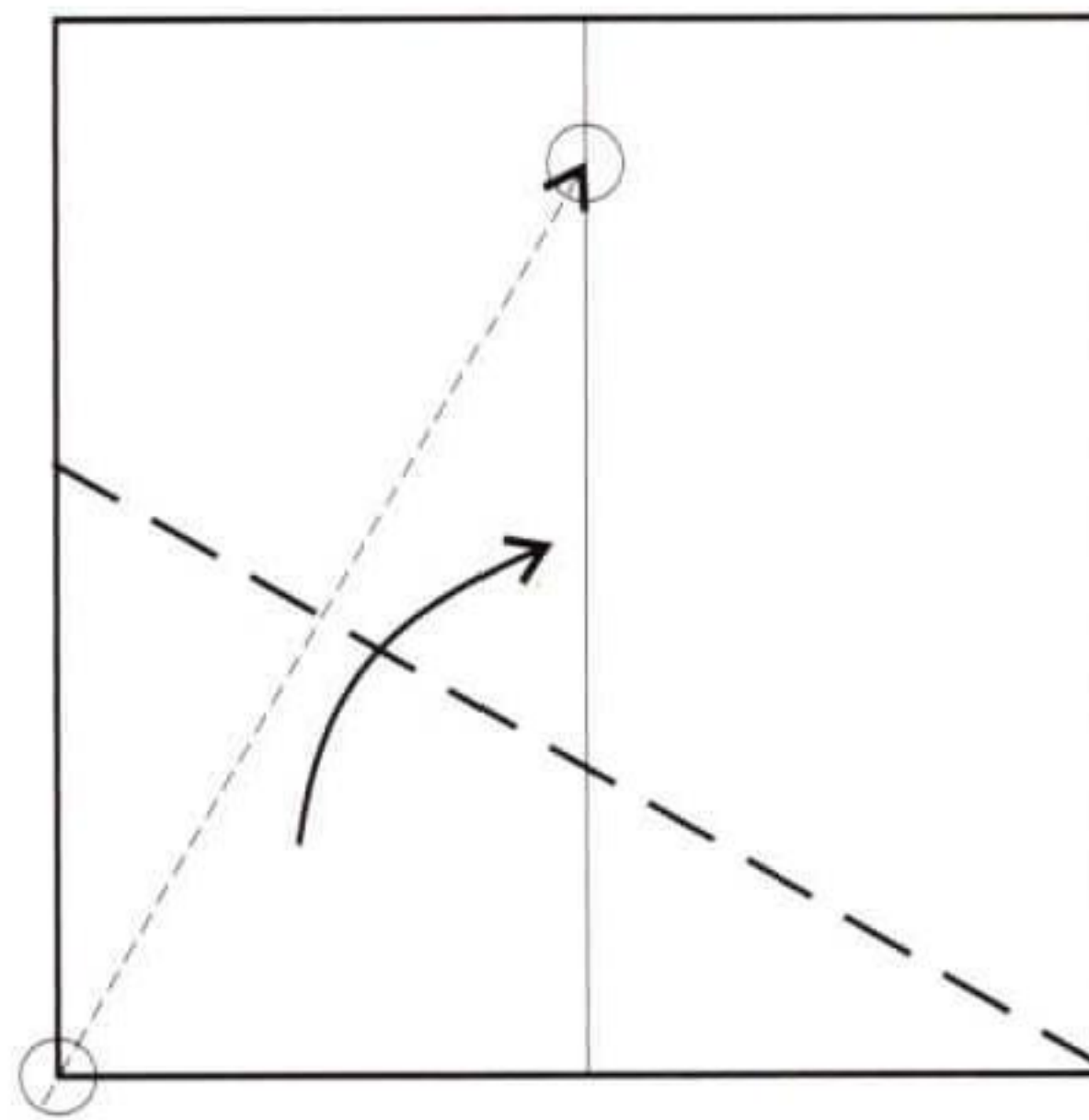

- 2 Fold the lower corner up to touch the middle crease.

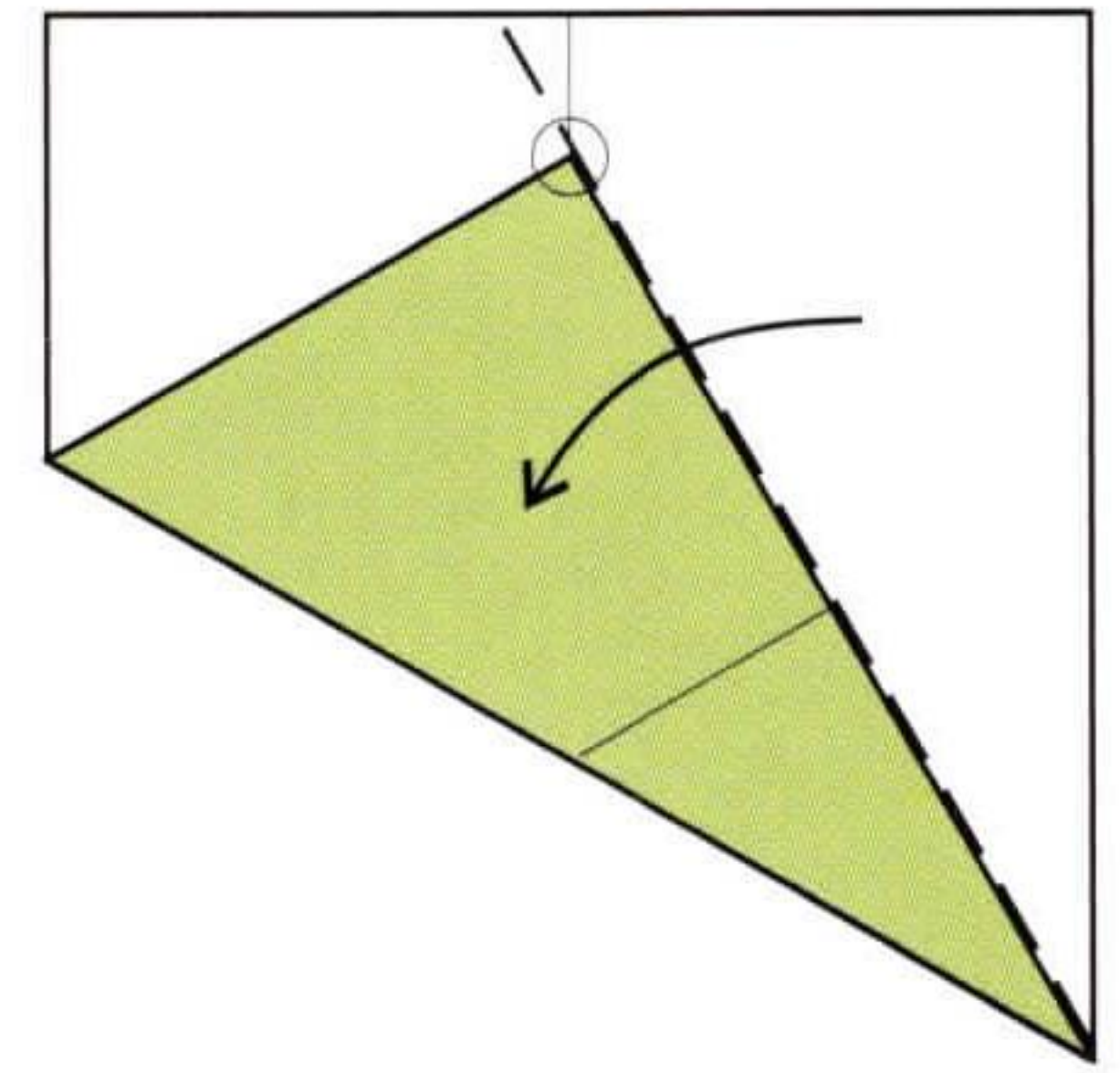

- 3 Fold the opposite side over.

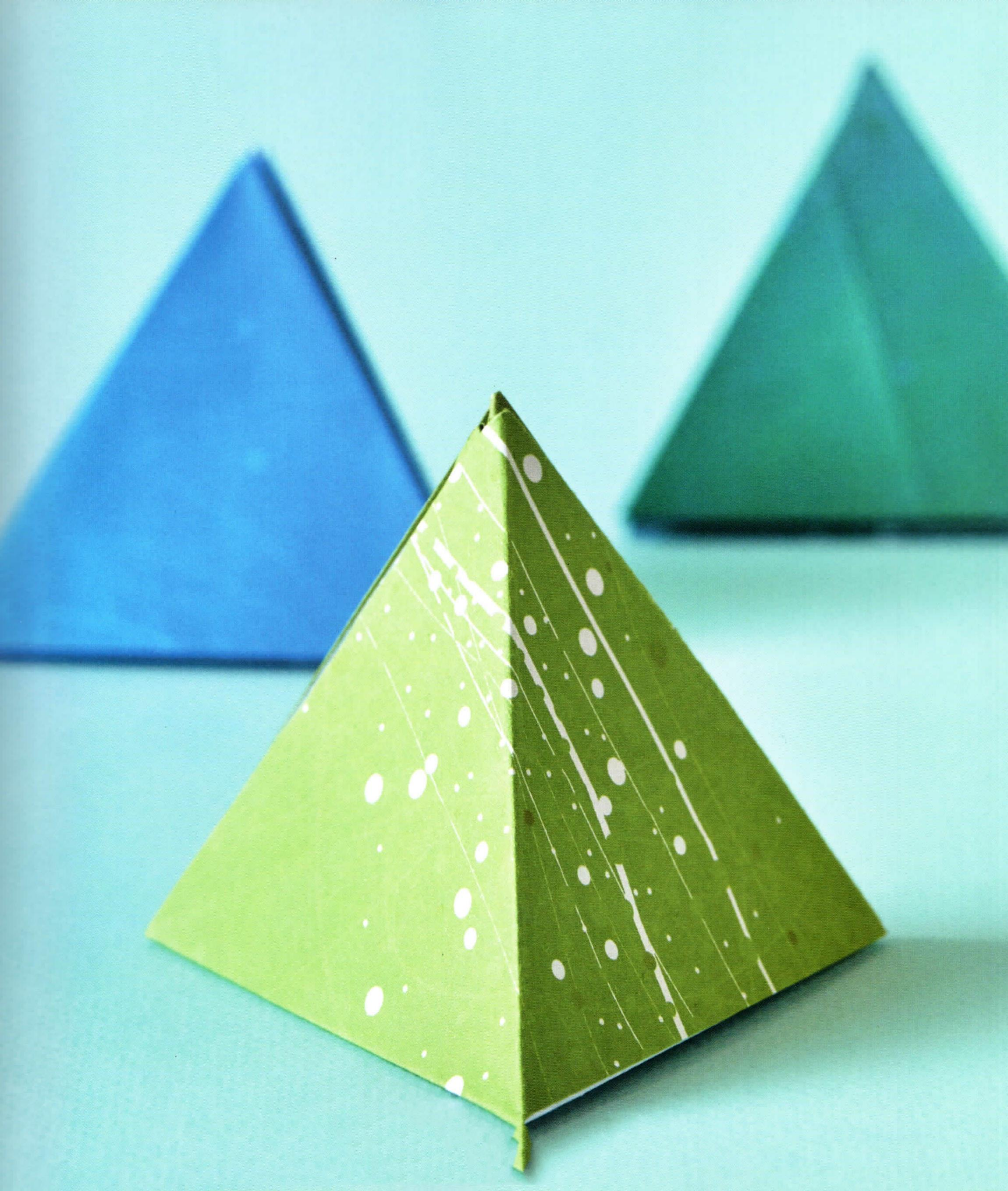

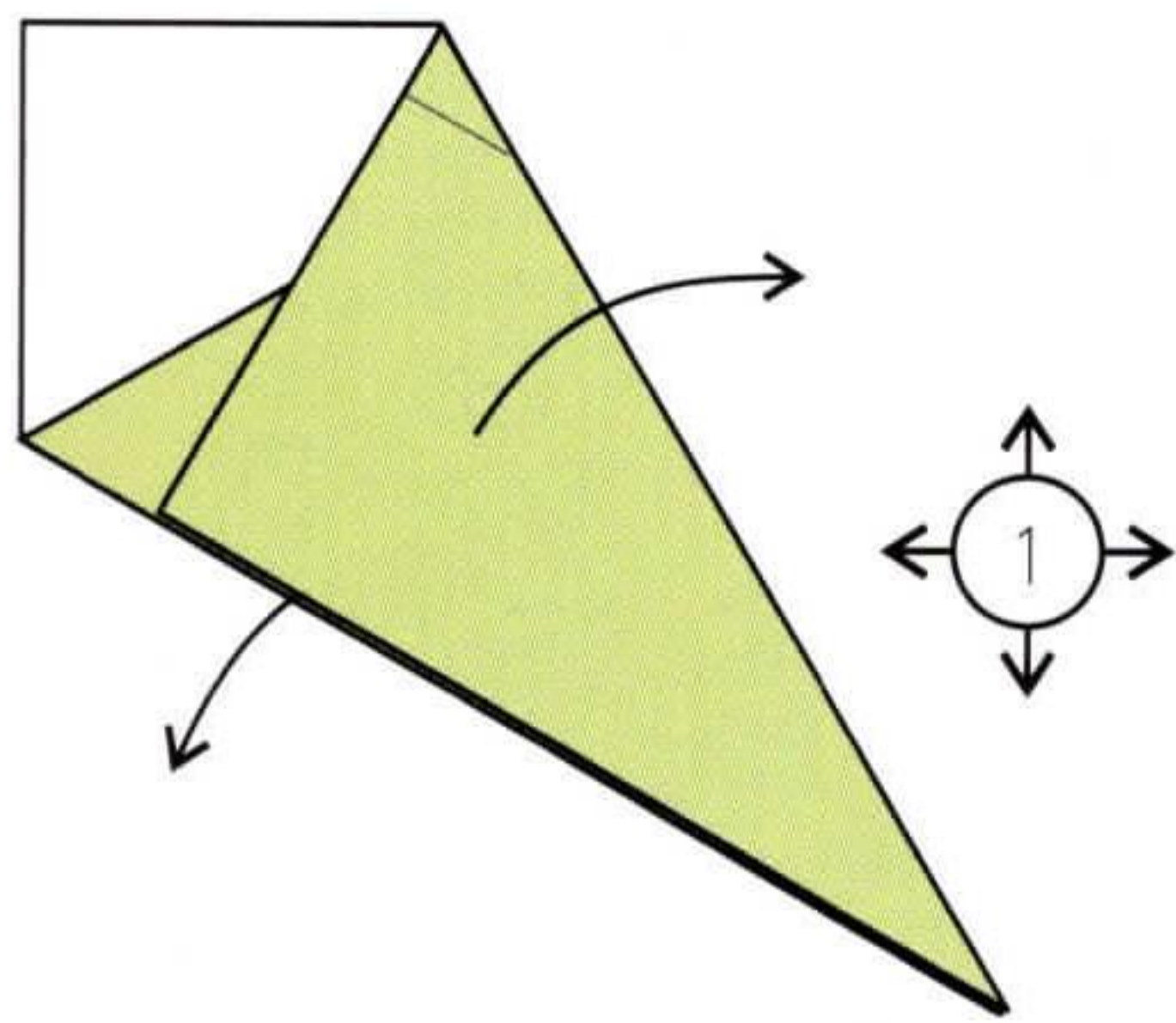

4 Unfold back to a square.

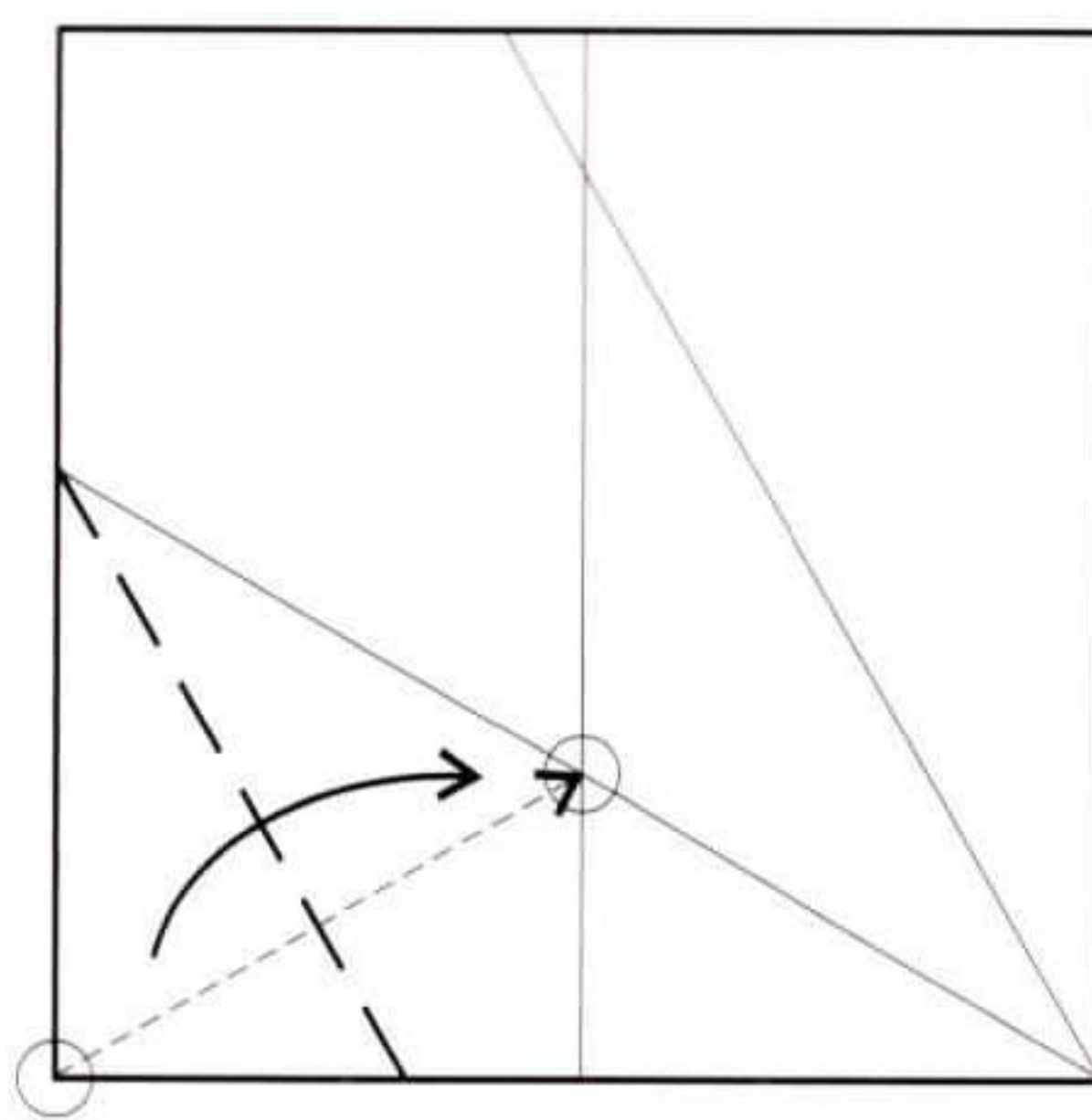

5 Fold the bottom left corner in so that the edge of the section is aligned with the crease.

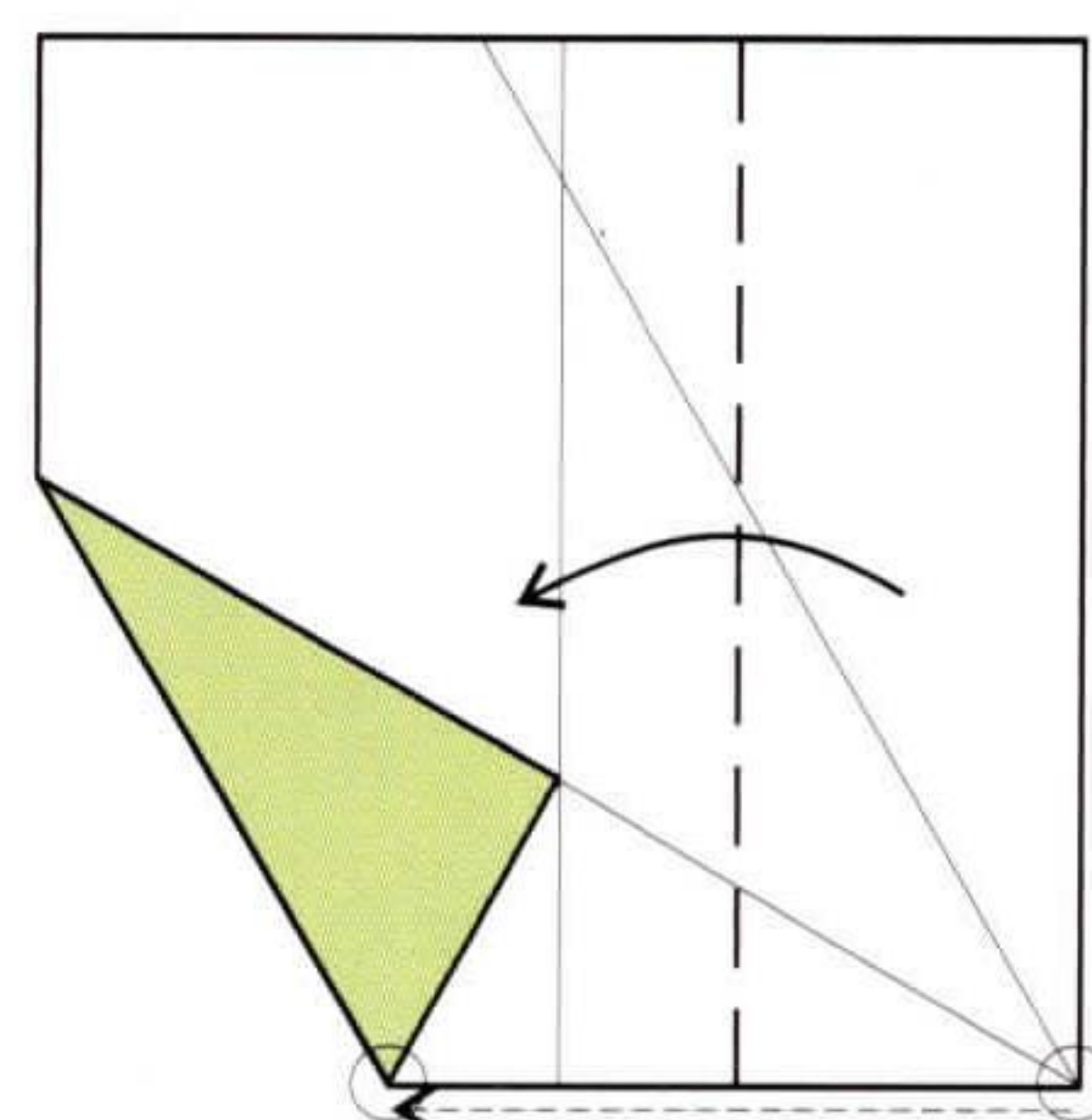

6 Fold the right edge over. The opposite corner should touch the folded corner made previously.

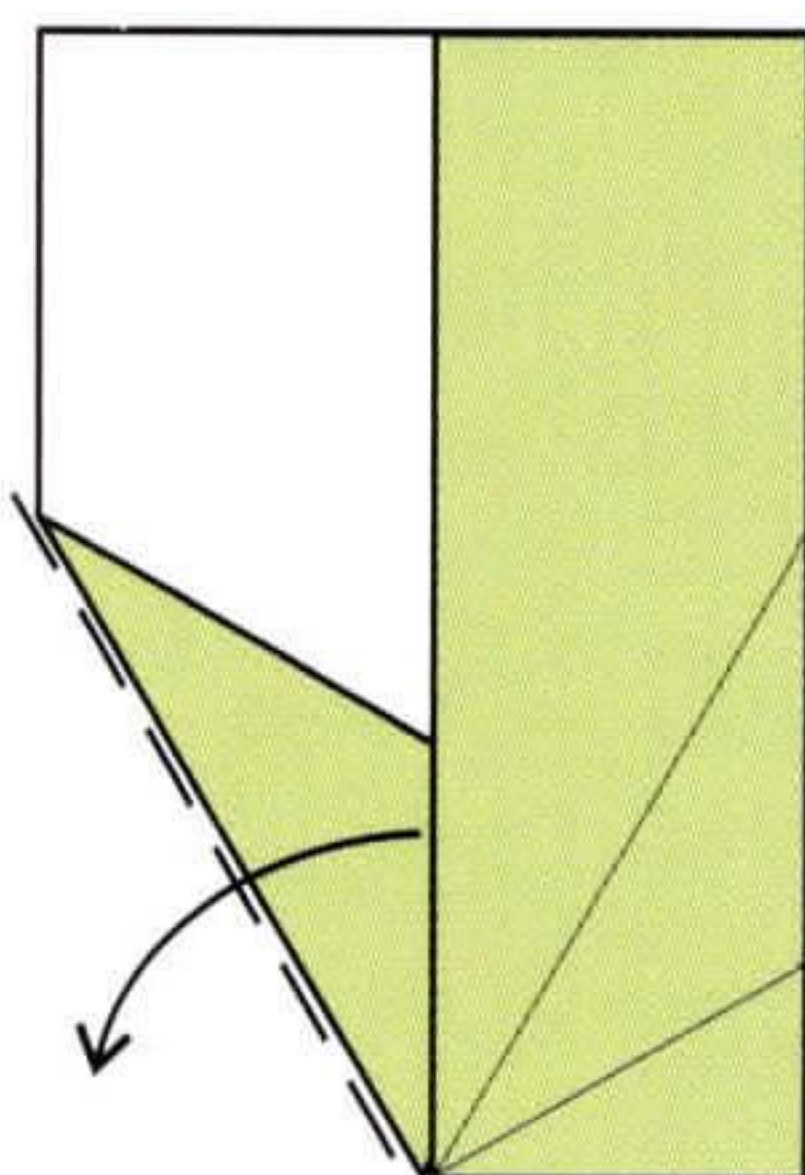

7 Fold the corner back out.

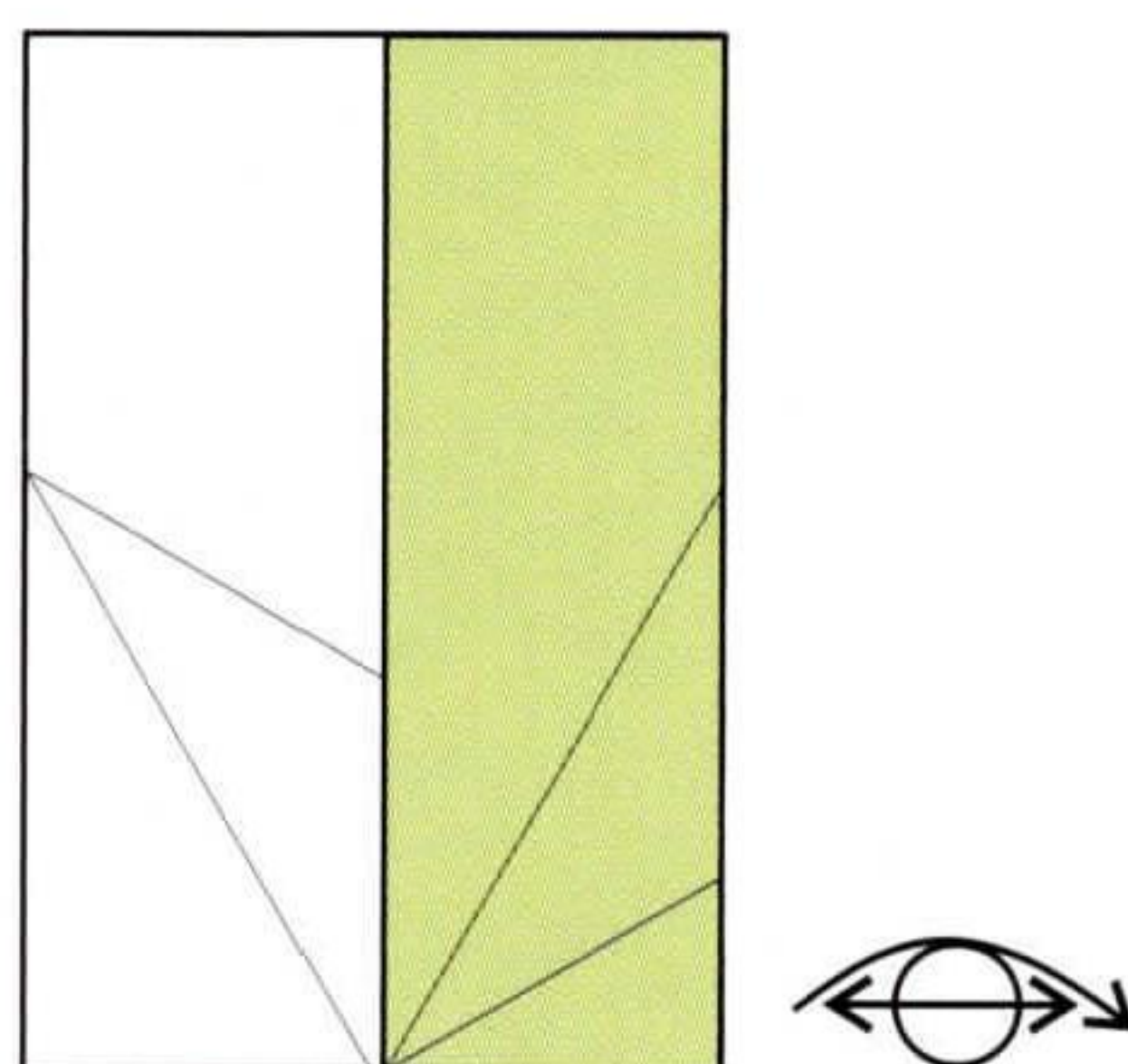

8 Turn the model over left to right.

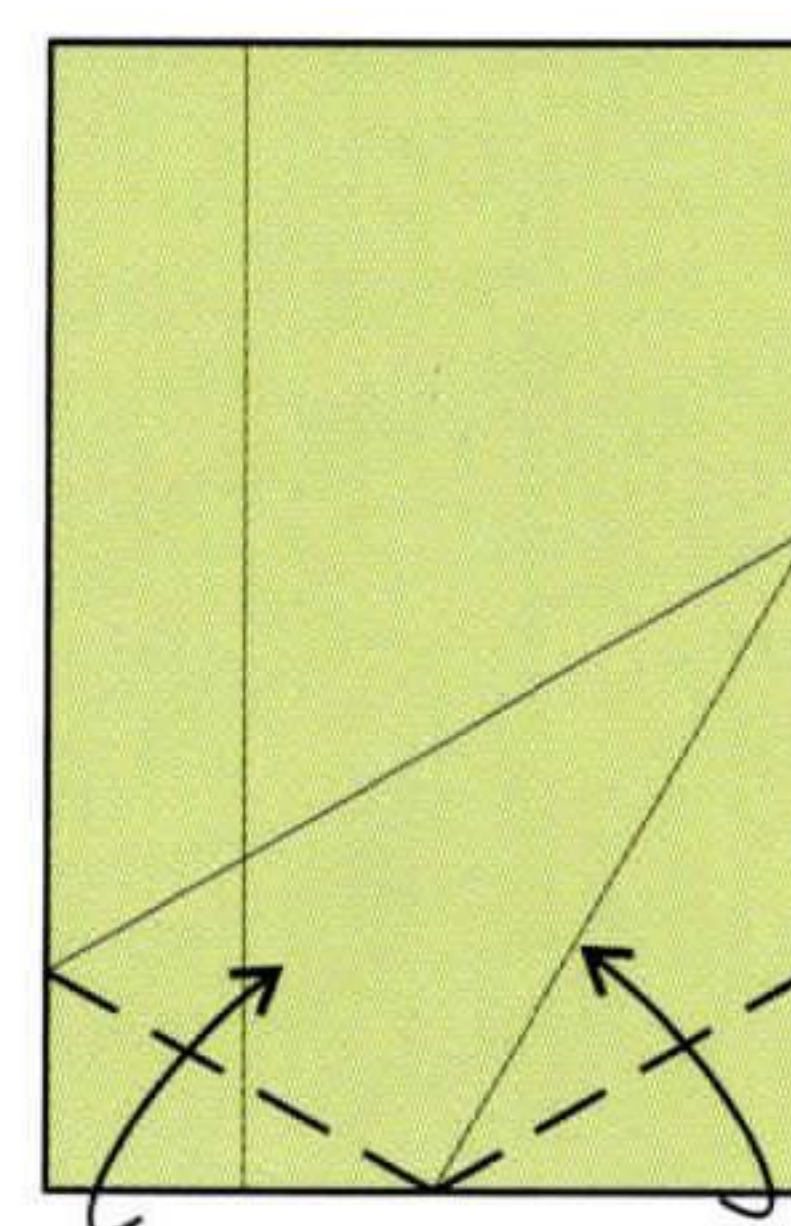

9 Fold the corners up on both sides. The lower edge should touch the adjacent diagonal creases.

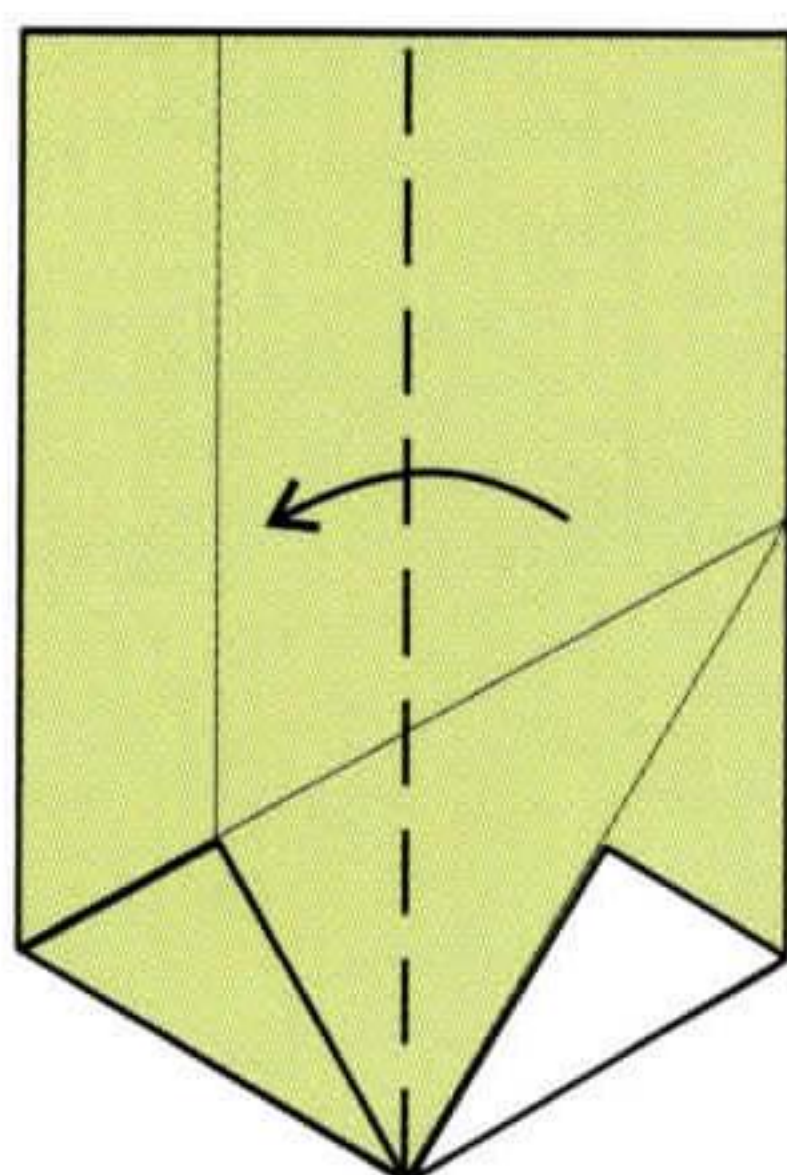

10 Fold one side over to fold the model in half.

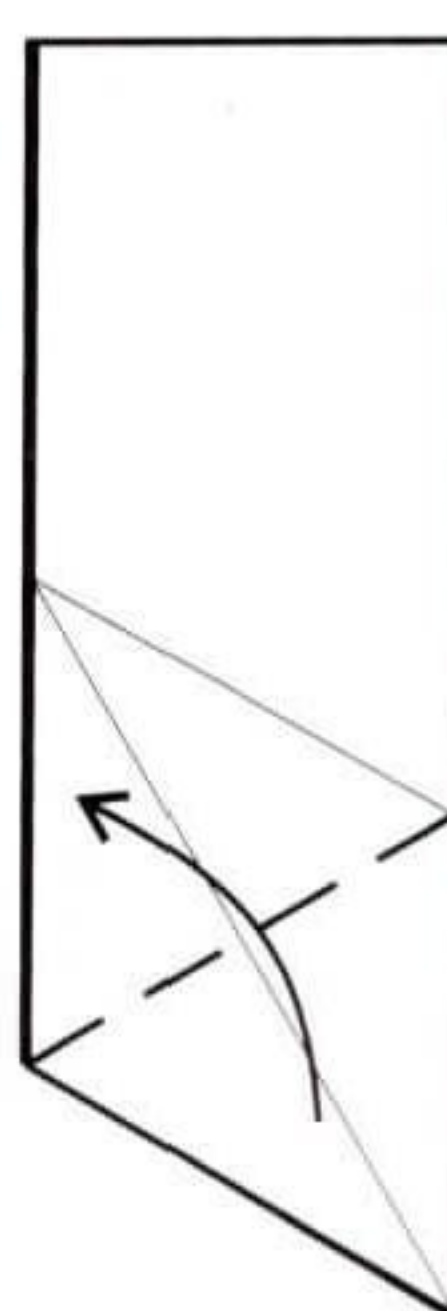

11 Fold up the lower corner.

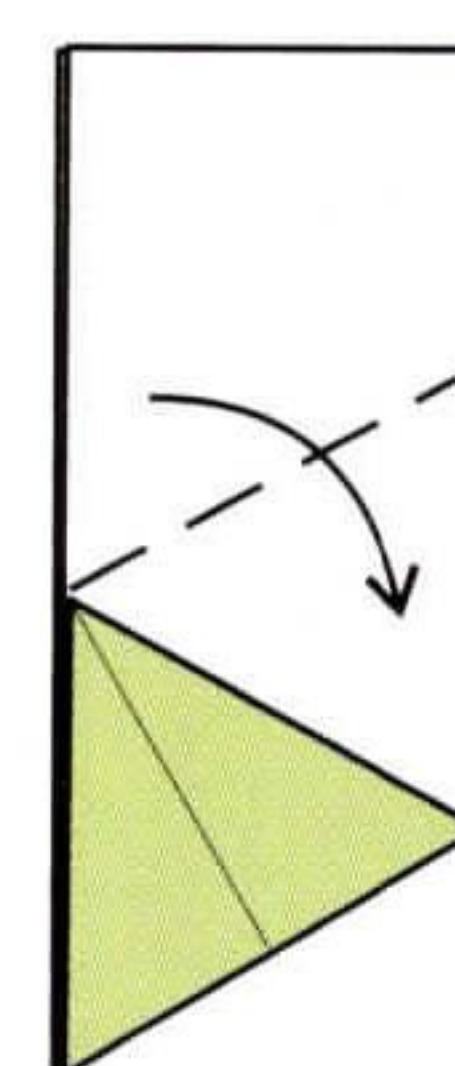

12 Fold down the upper section. The outer edge should touch the edge of the lower section.

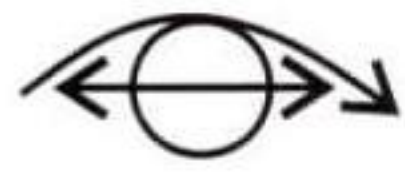
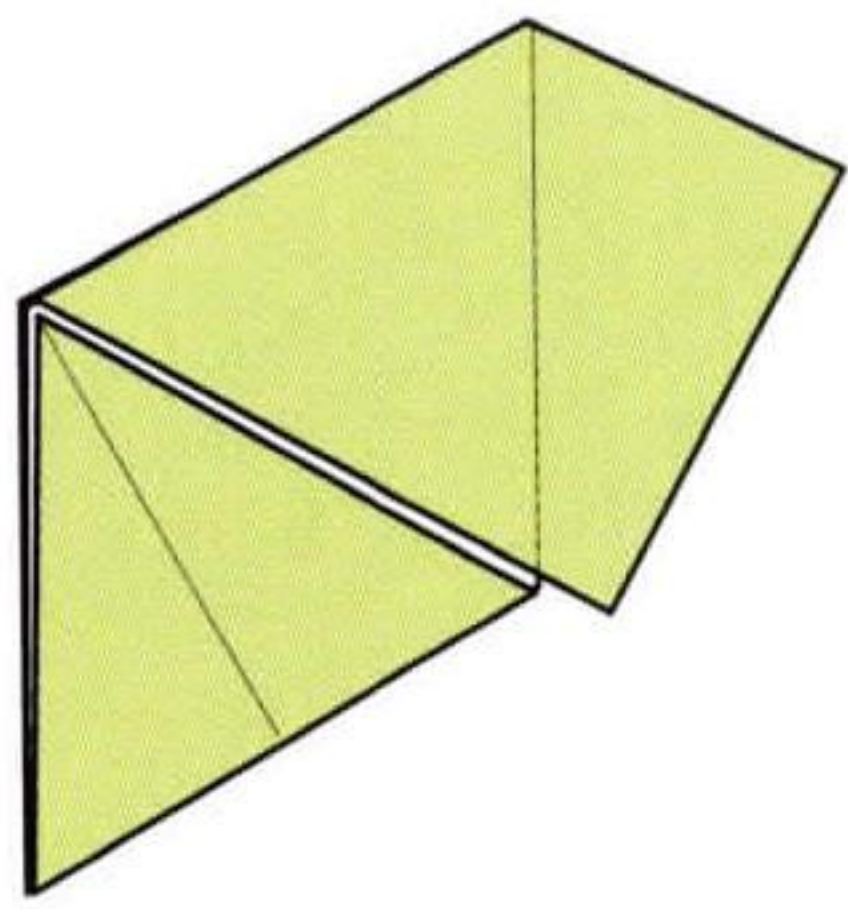

13 Turn the model over left to right.

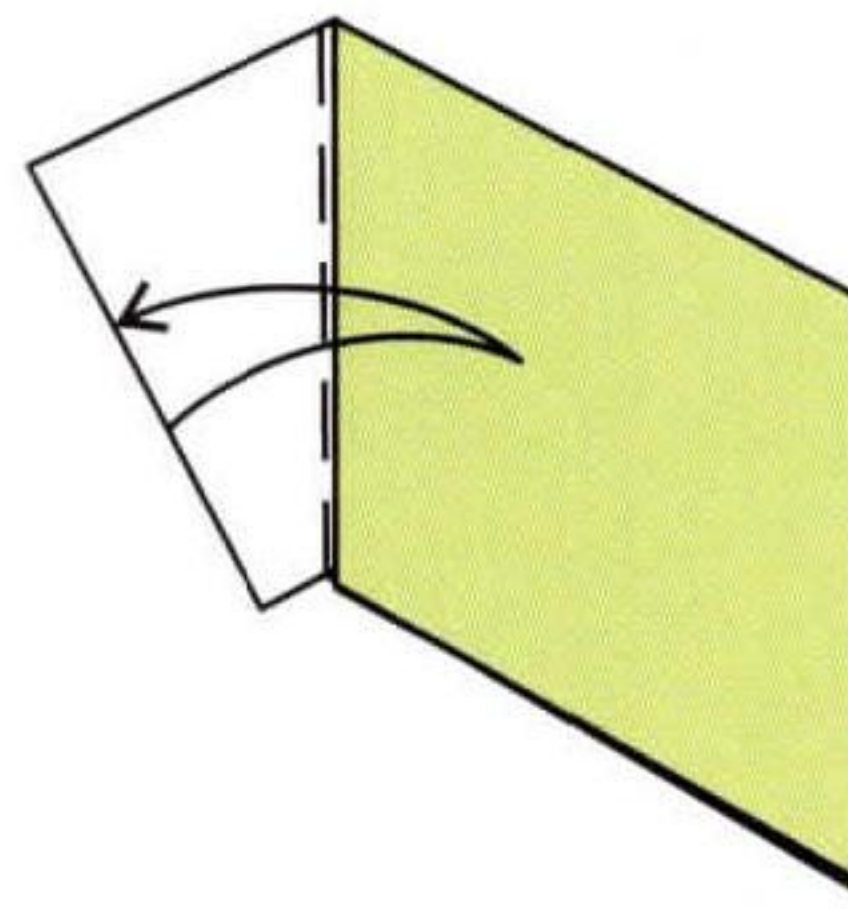

14 Fold the upper section in and out again along the adjacent edge of the paper.

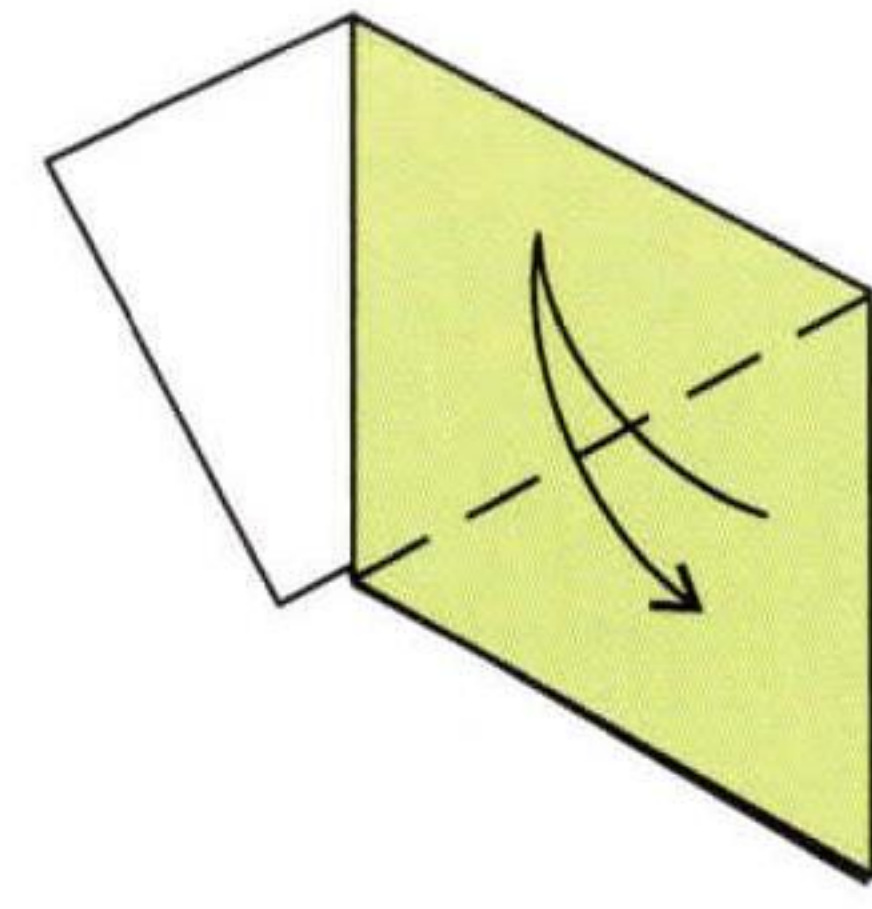

15 Fold and unfold between the outer corners of the diamond shape.

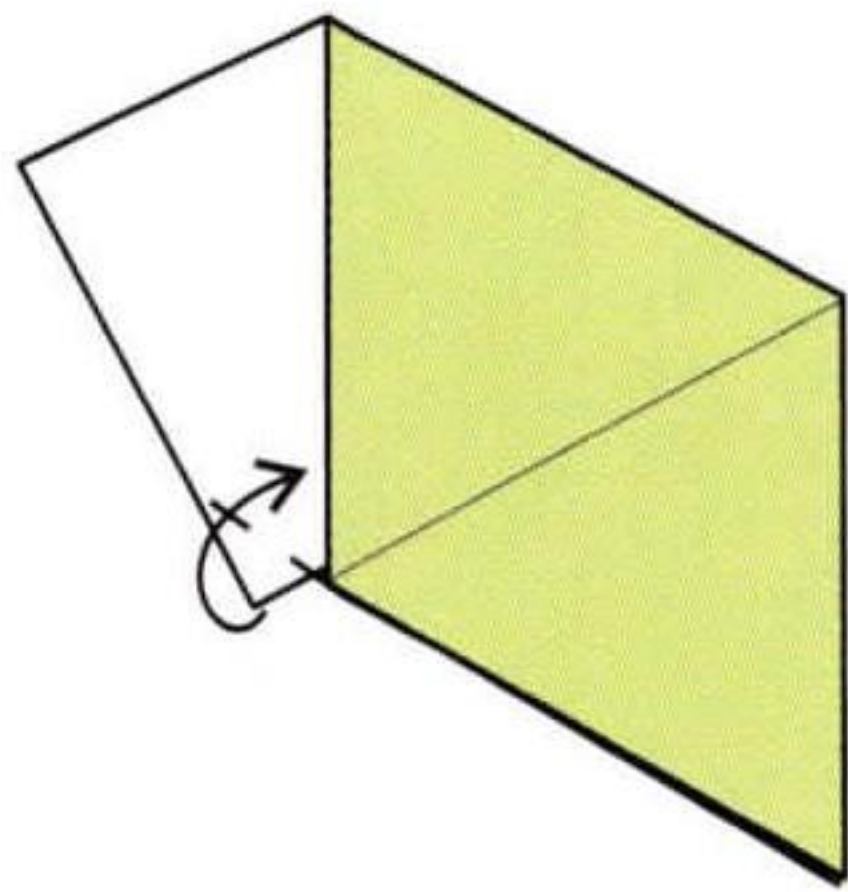

16 Fold the outer corner in.

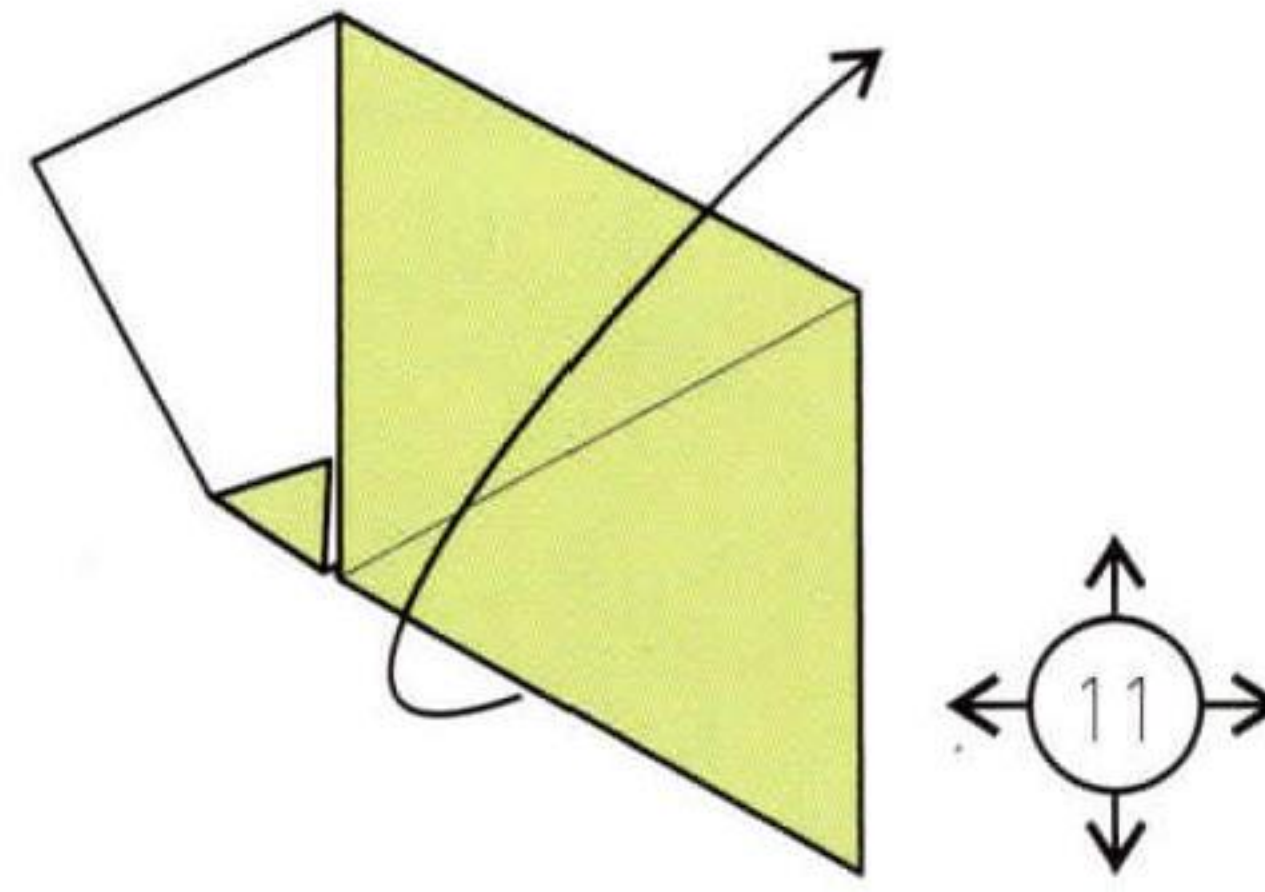

17 Unfold the previous folds to step 11, but leave the corner folded over in step 16 folded.

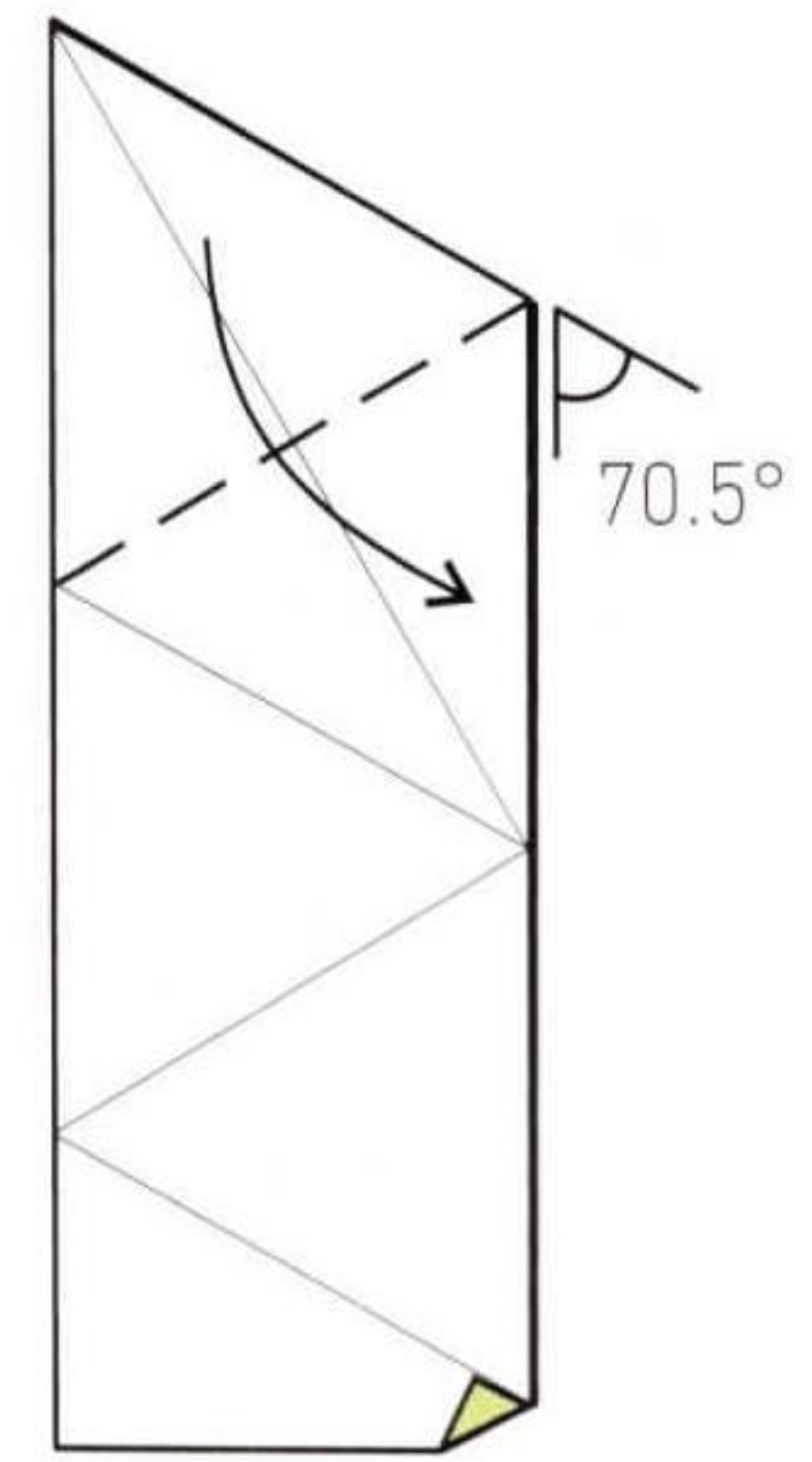

18 Fold the upper corner in at an angle.

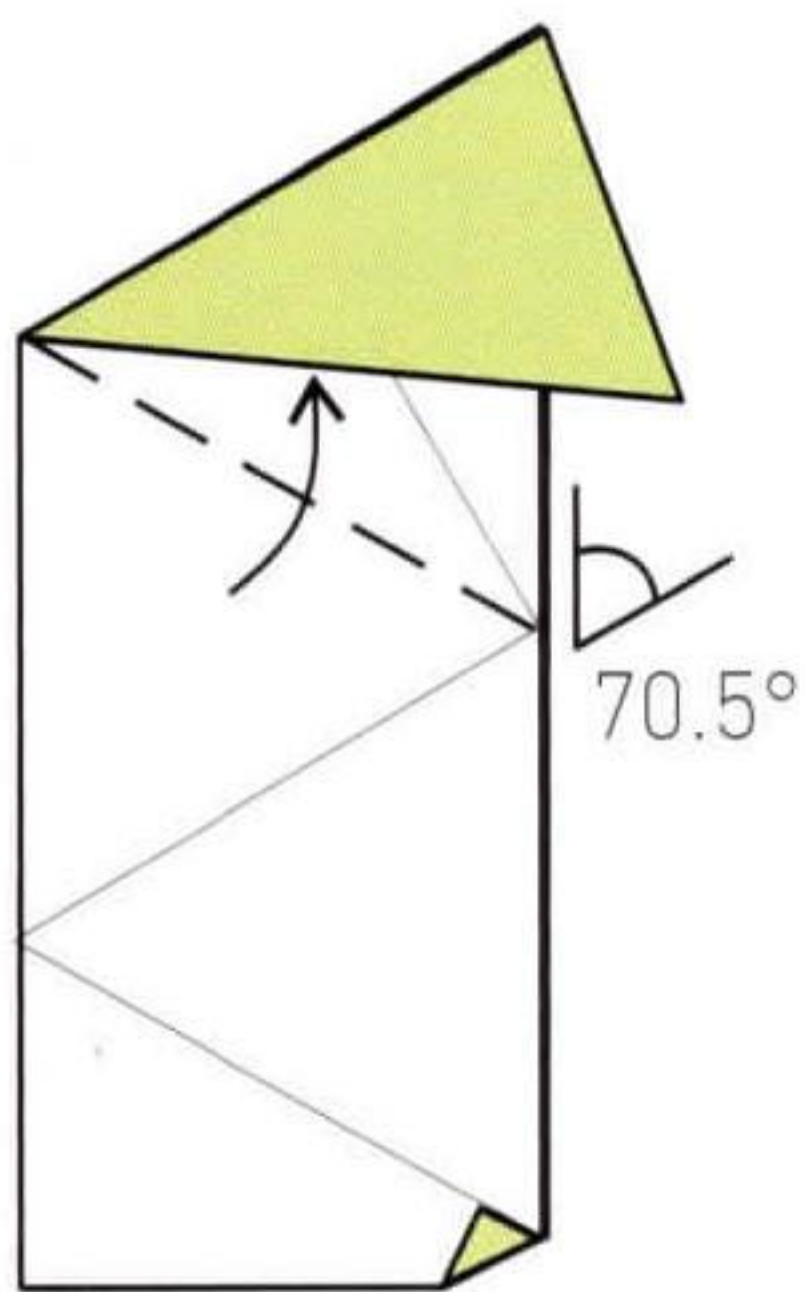

19 Fold the lower section up so that the edge of the lower and upper sections touch.

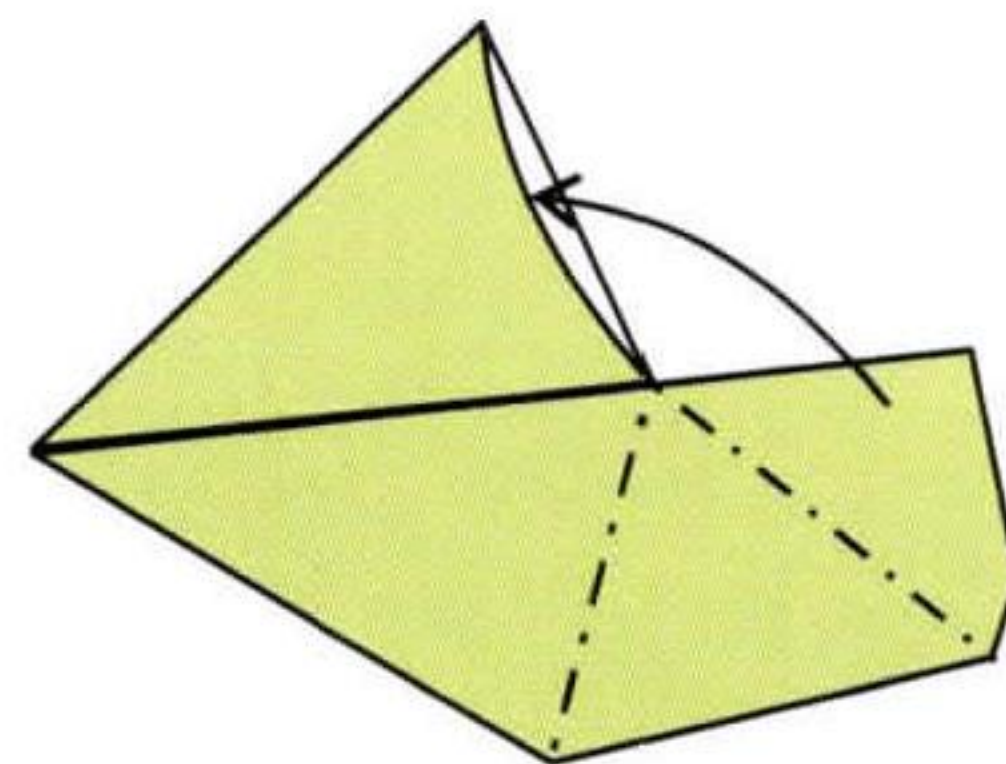

20 Fold the paper around and tuck the corner into a pocket formed by the layers of paper.

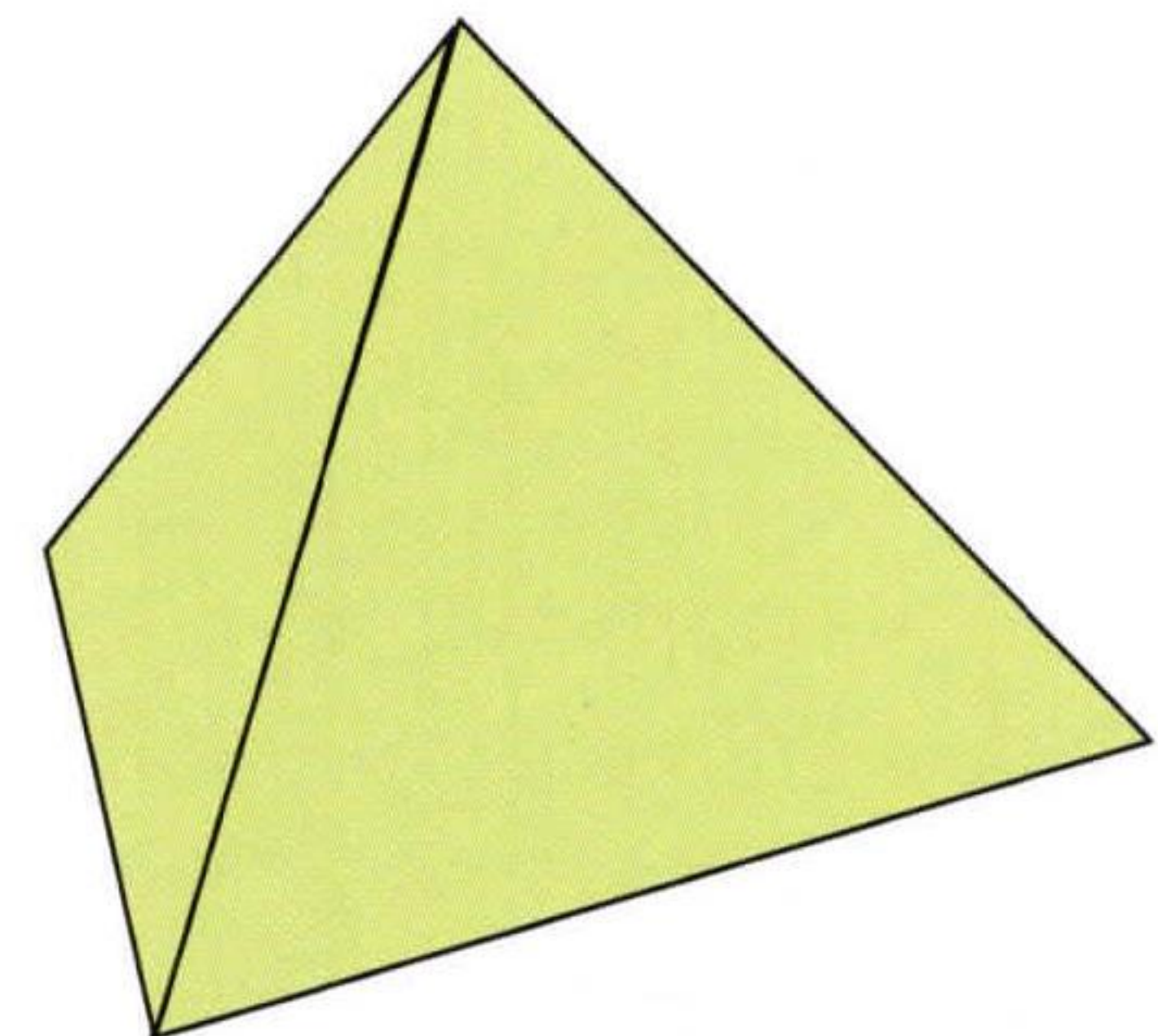

21 Complete.

Cube

*

The cube is the second of the platonic solids, a shape made from six square faces. The model is folded by developing the geometry of the square and making smaller squares within the larger one. As a platonic solid, the cube is associated with the earth.

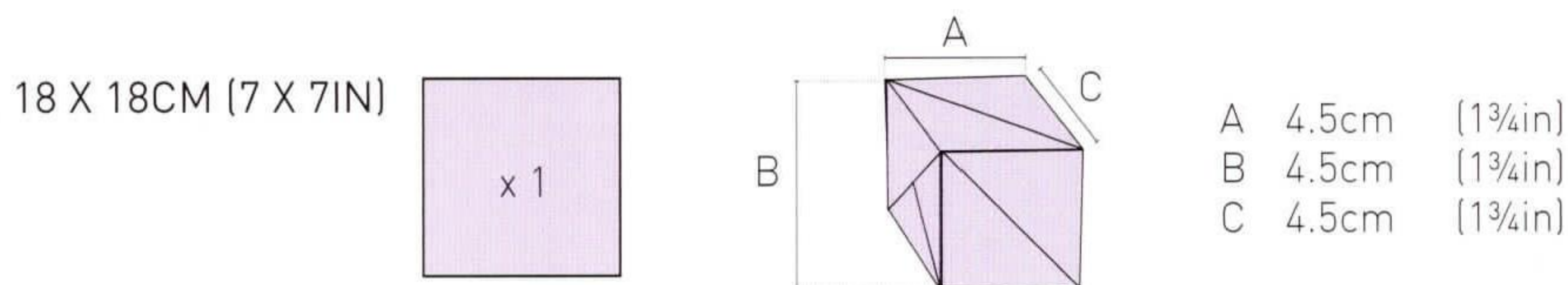

START WITH A SQUARE, COLOURED SIDE UP.

-
- 1** Fold and unfold the square in half lengthwise. Then turn the model over left to right.
-
- 2** Fold the edges to touch the centre crease and unfold.
-
- 3** Repeat the process on the other axes to divide the paper into 16 sections.
-
- 4** Fold and unfold the square diagonally.
-
- 5** Fold and unfold diagonally. The line styles show Valley or Mountain Folds.
-
- 6** Fold the sides in so they are perpendicular to each other.
-
- 7** Fold the corner up to be flush with the side of the model.
-
- 8** Fold upper edge (a) down first, then fold (b) over it so they are both perpendicular to the lower section.

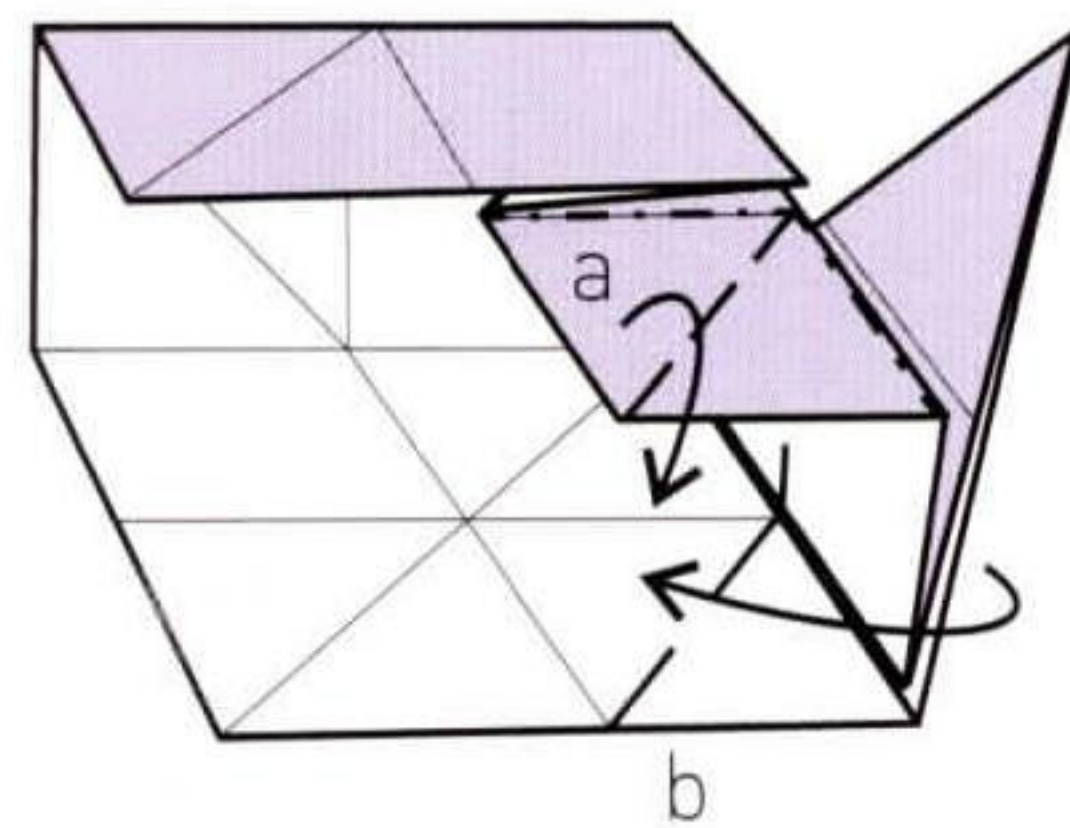
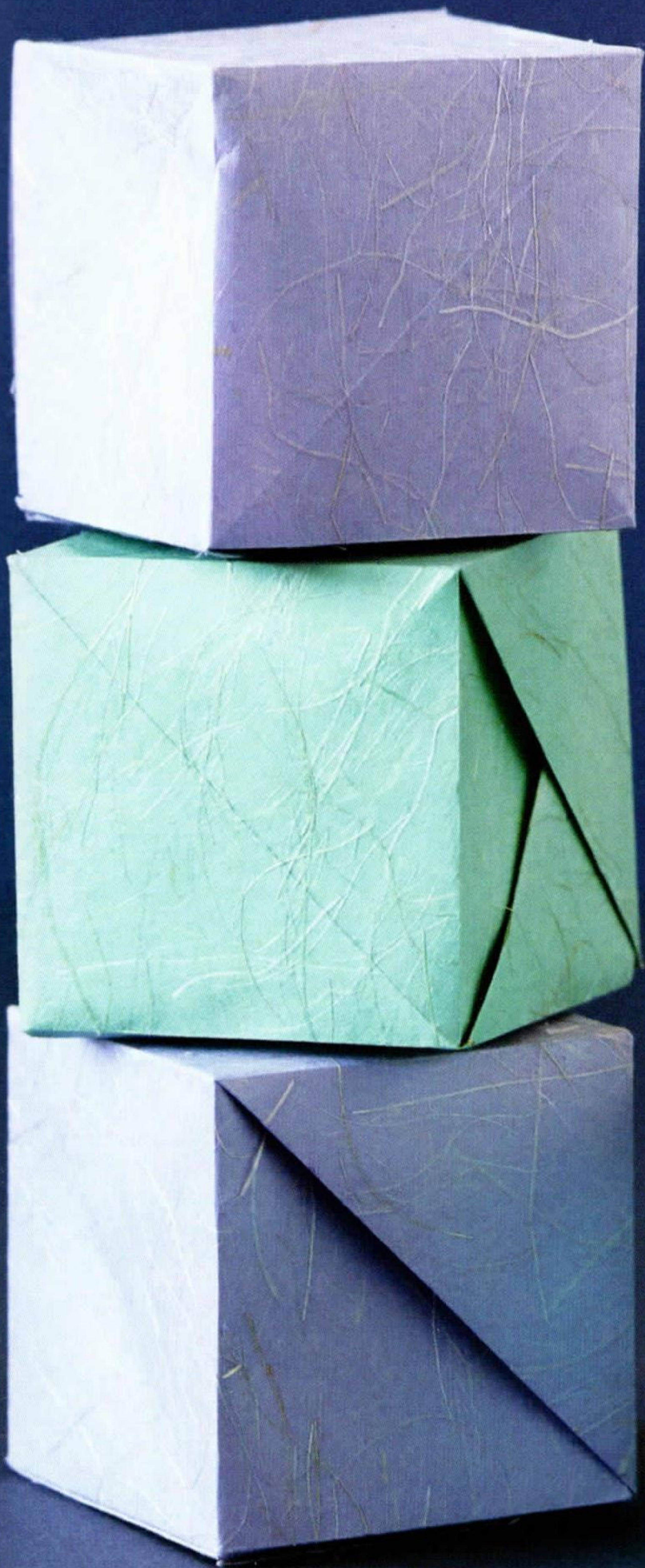

- 9 Fold one side in, at the same time folding in the corner at (a) and making a diagonal fold at (b).

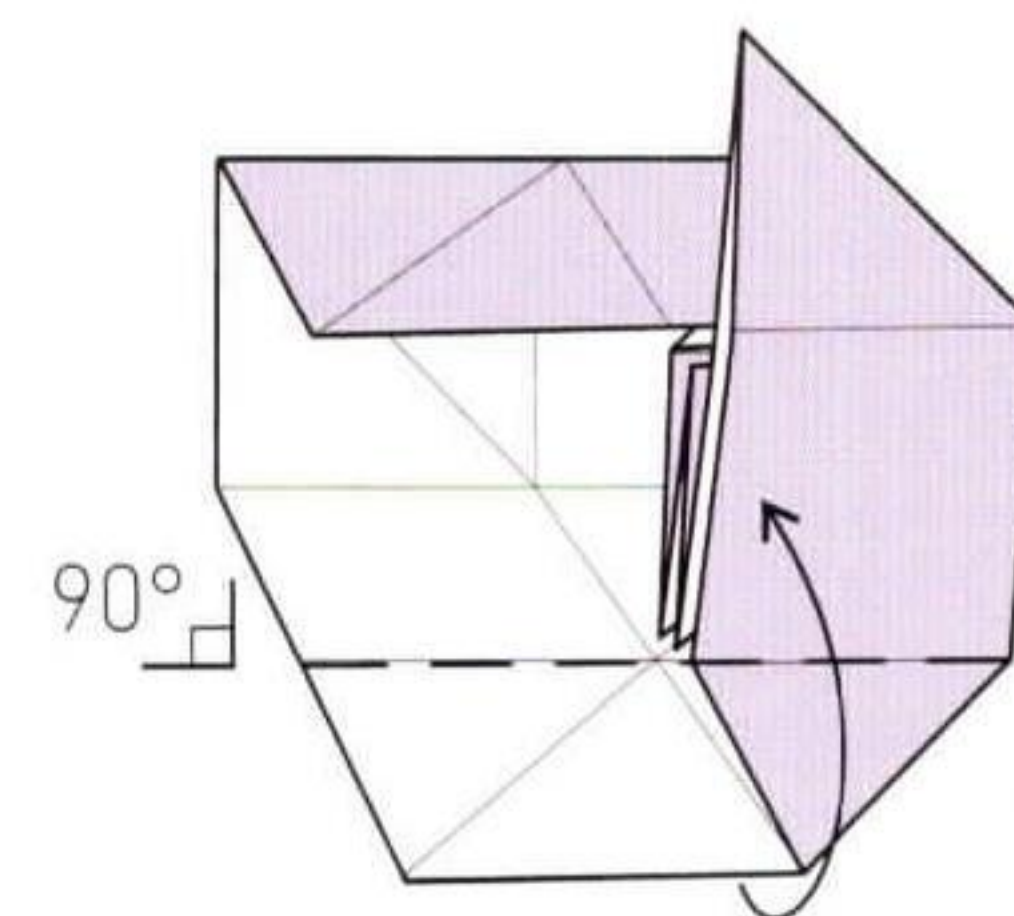

- 10 Fold the edge up.

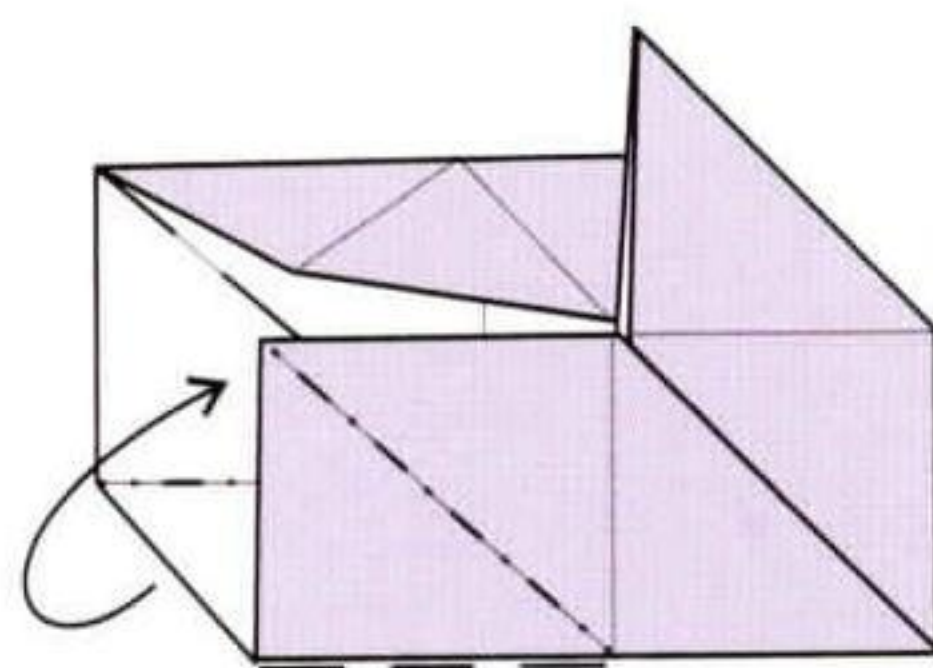

- 11 Reverse fold the lower section into the model along two diagonal folds.

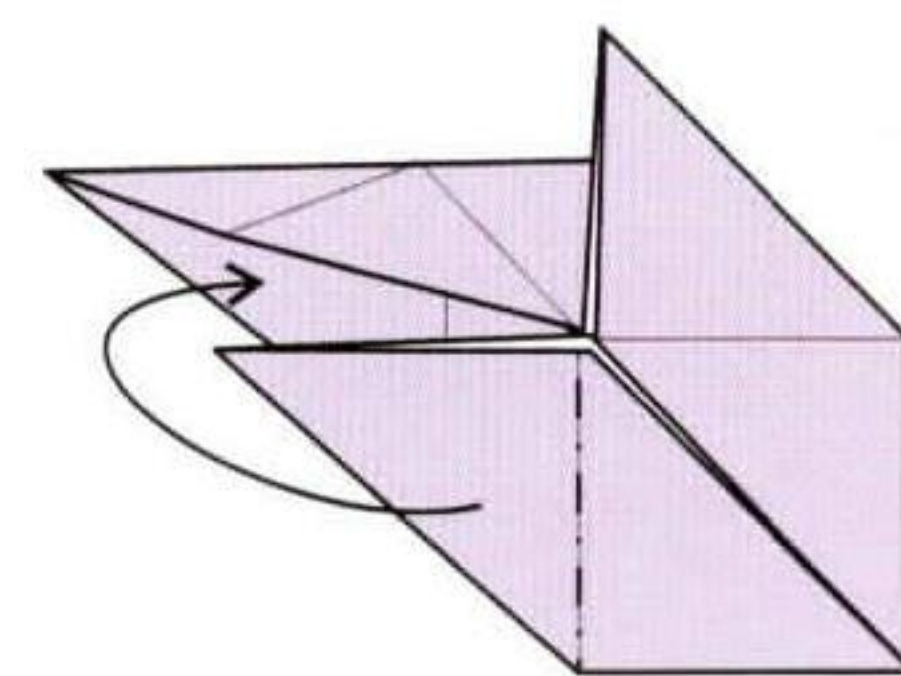

- 12 Fold the triangular corner in to touch the side of the cube.

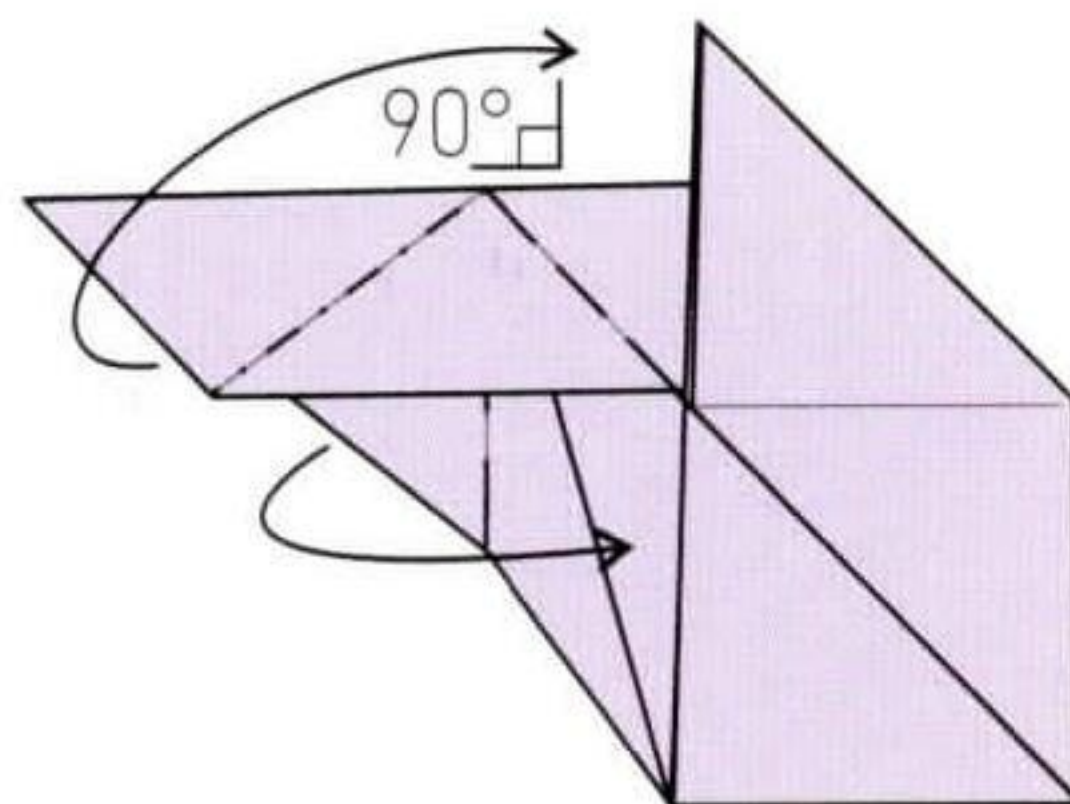

- 13 Fold the upper section upwards, then fold it flat against the side of the cube.

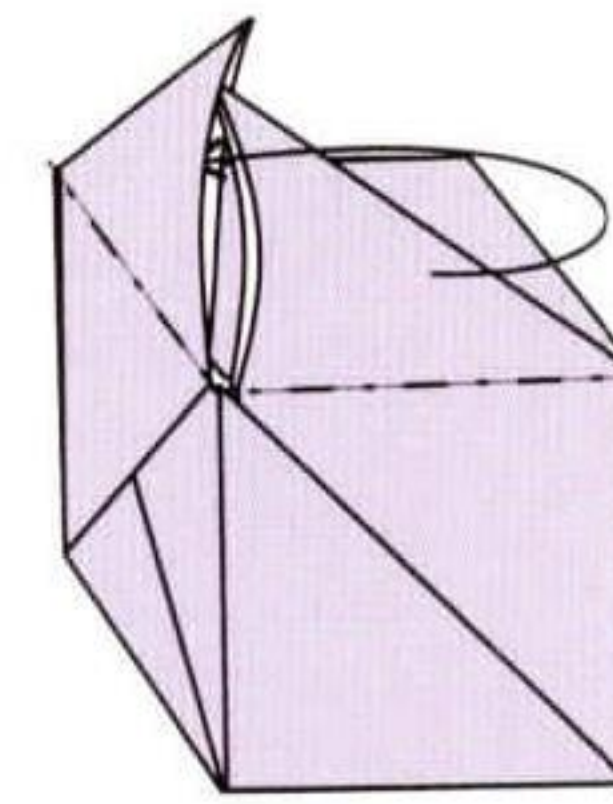

- 14 Fold the upper section up, flat against the top of the cube. Tuck one triangular point into the other.

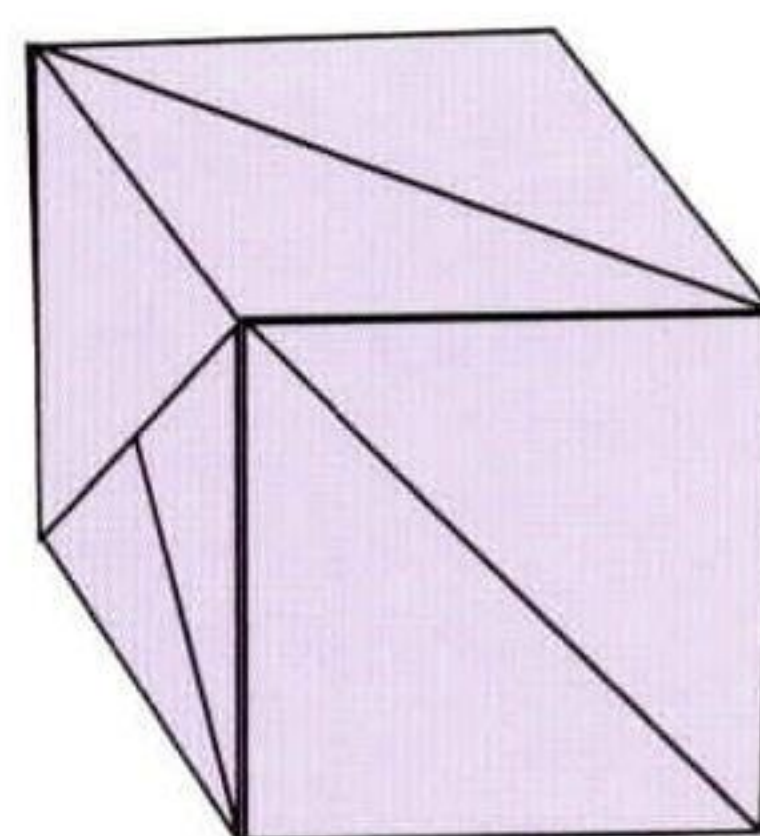

- 15 Complete.

Hexahedron



This model starts from the classic fortune teller (see page 10) and then uses the spaces in the model to make a solid shape. The final step is particularly pleasing as it ends with a corner of the model being tucked into a pocket created in the edge of the regular solid.

18 X 18CM (7 X 7IN)

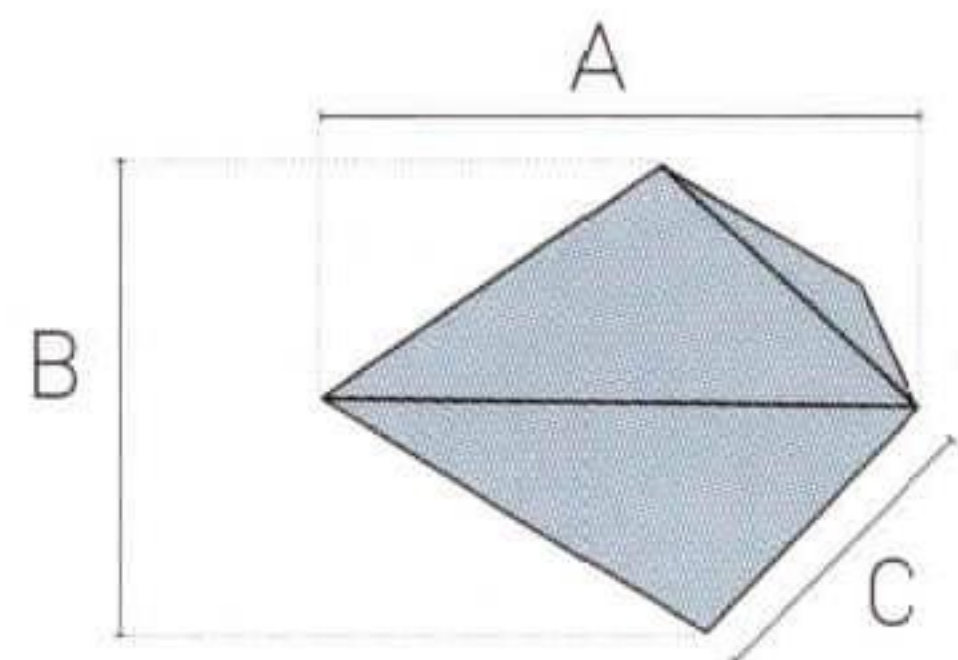
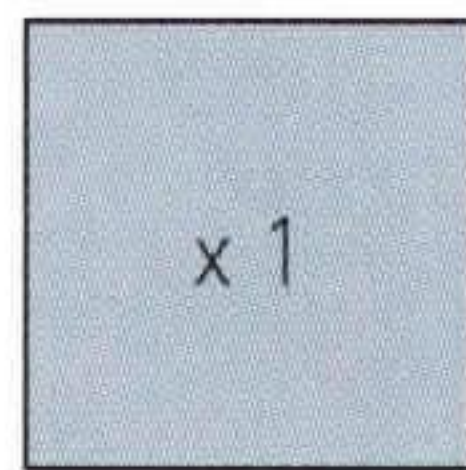

A 6.6cm [2 $\frac{2}{3}$ in]
 B 5.4cm [2in]
 C 6cm [2 $\frac{1}{3}$ in]

START WITH A SQUARE, COLOURED SIDE DOWN.

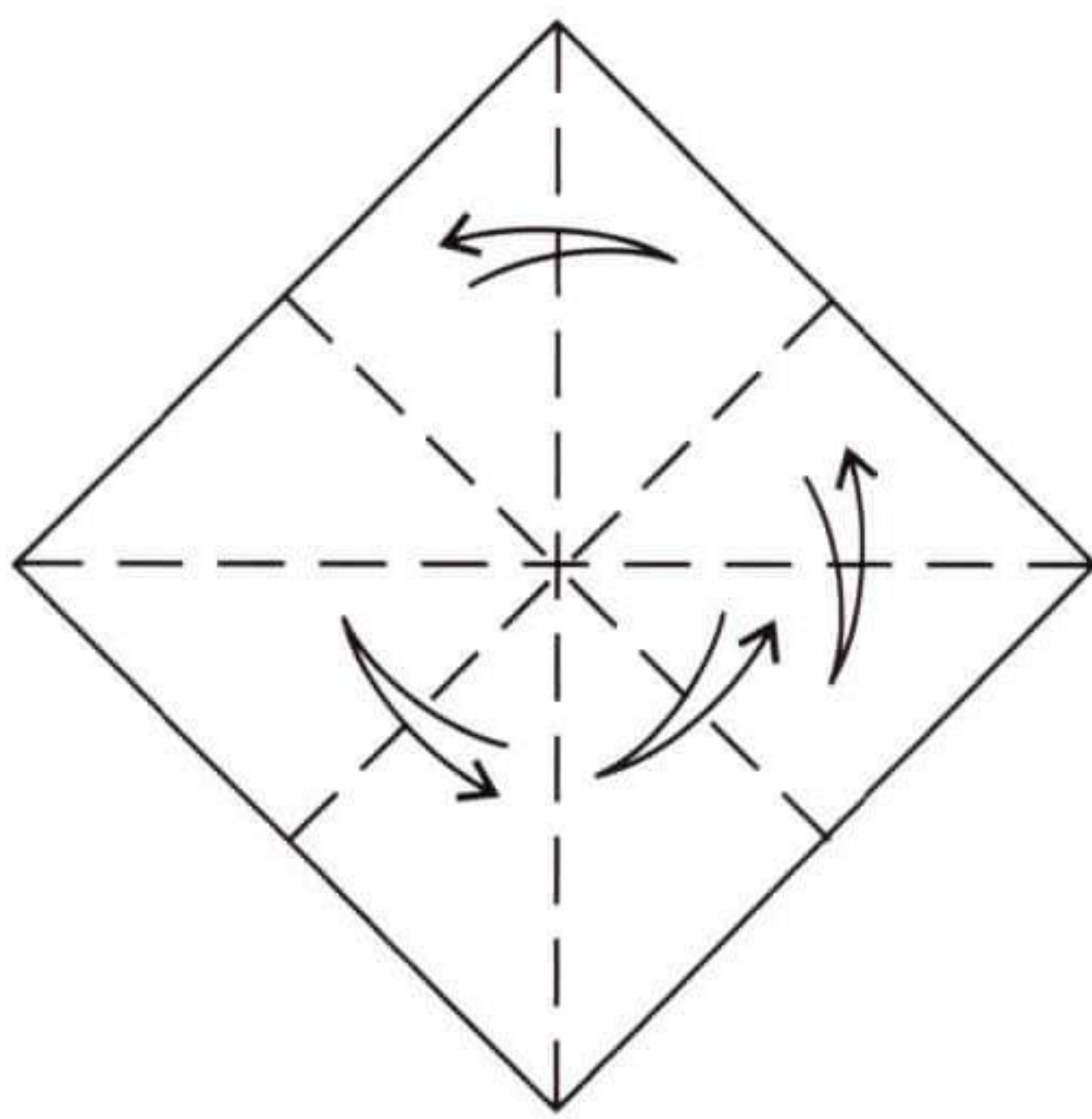

1 Fold and unfold the square in half lengthwise and diagonally along all axes.

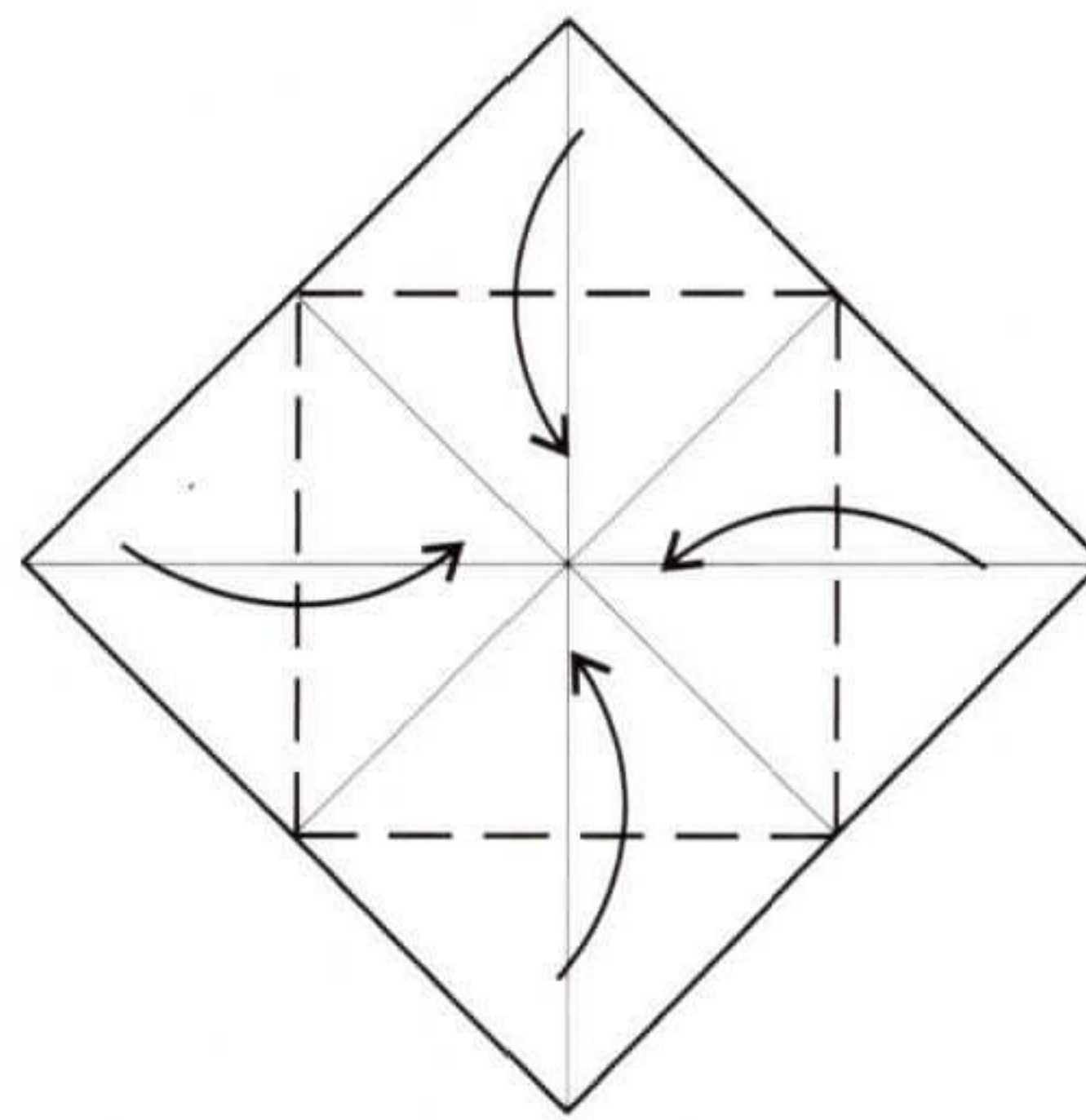

2 Fold the corners into the middle.

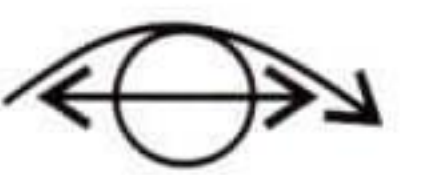
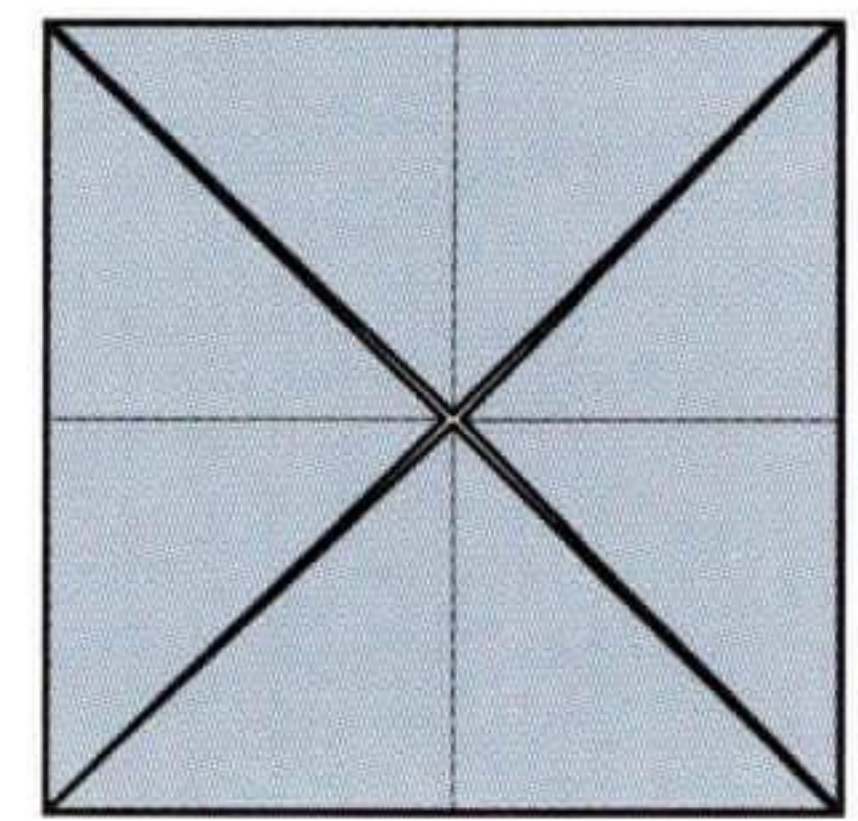

3 Turn the model over left to right.

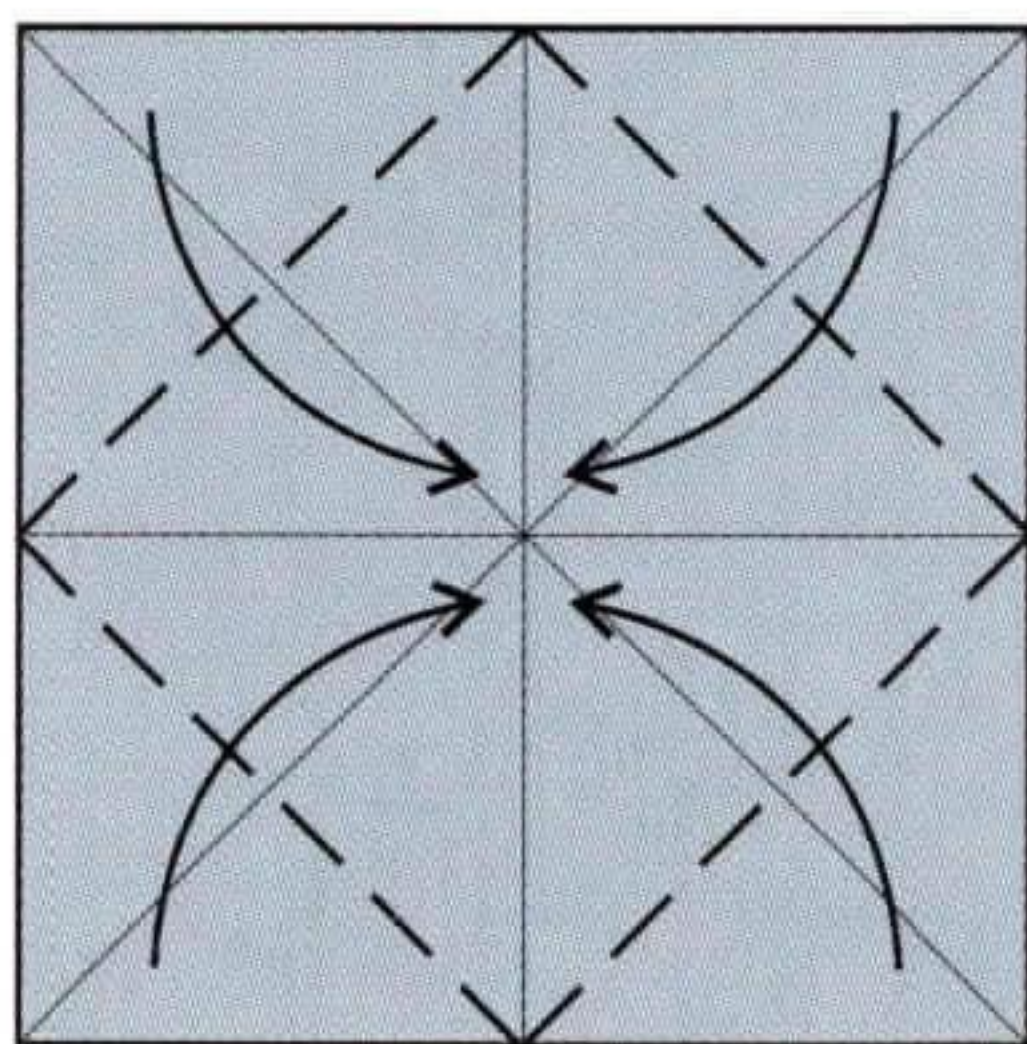

4 Fold the corners into the middle again.

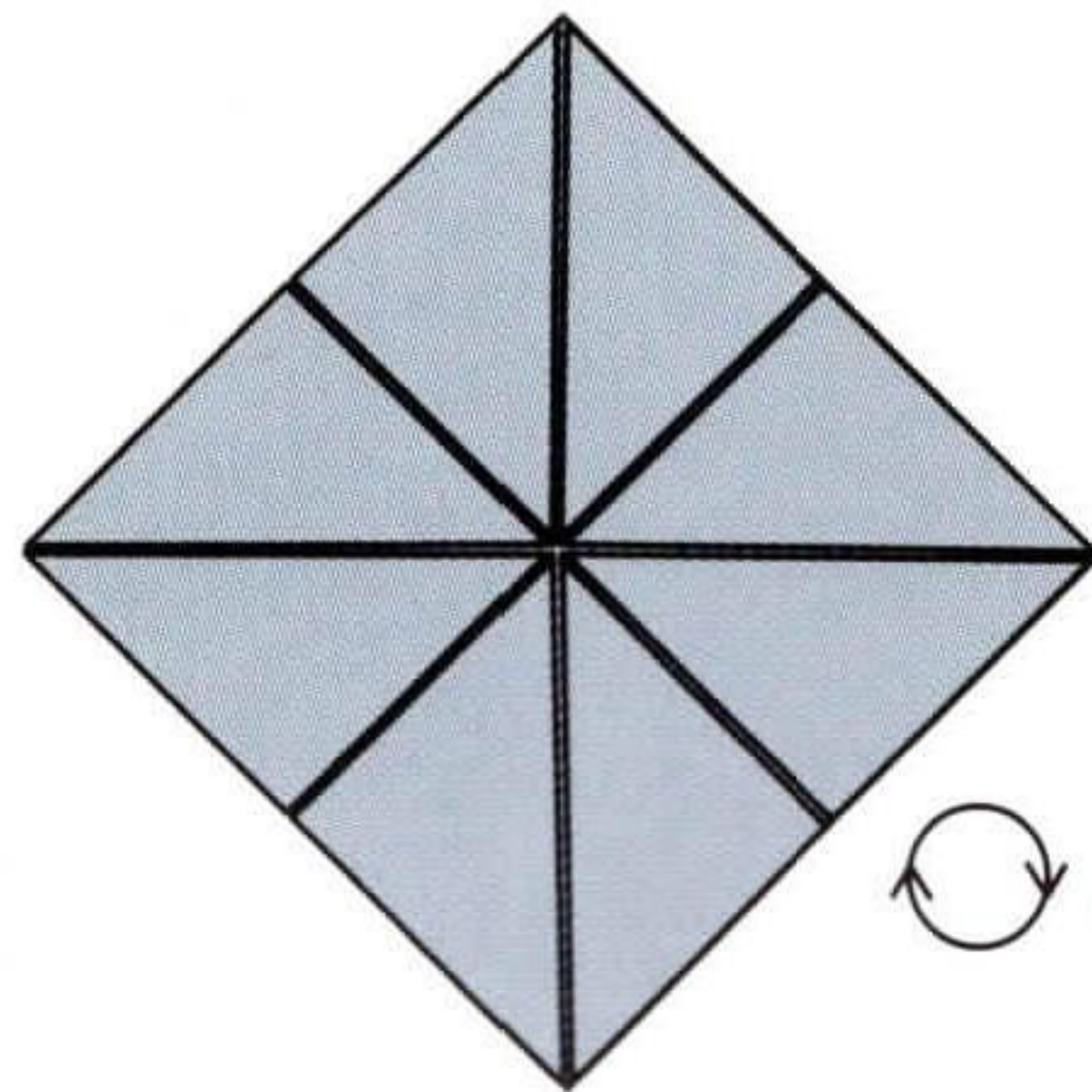

5 Rotate the model by 45°.

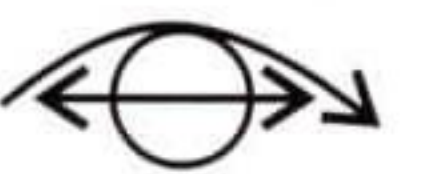
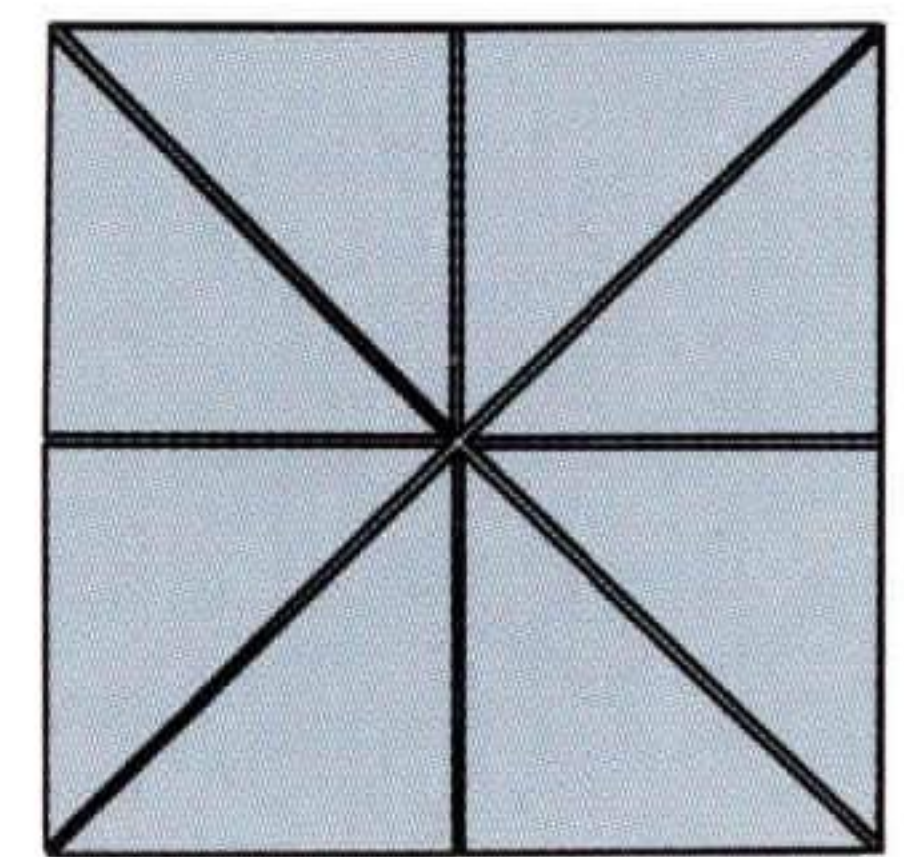

6 Turn the model over left to right.



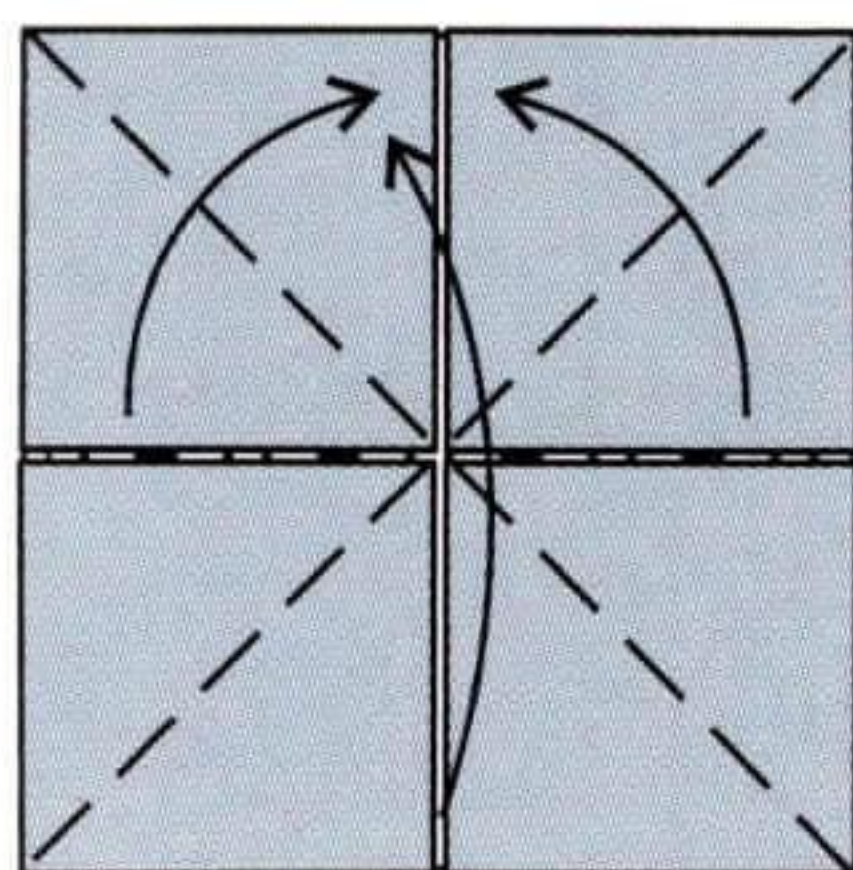

7 Fold the lower section up and the corners in, to form a waterbomb base.

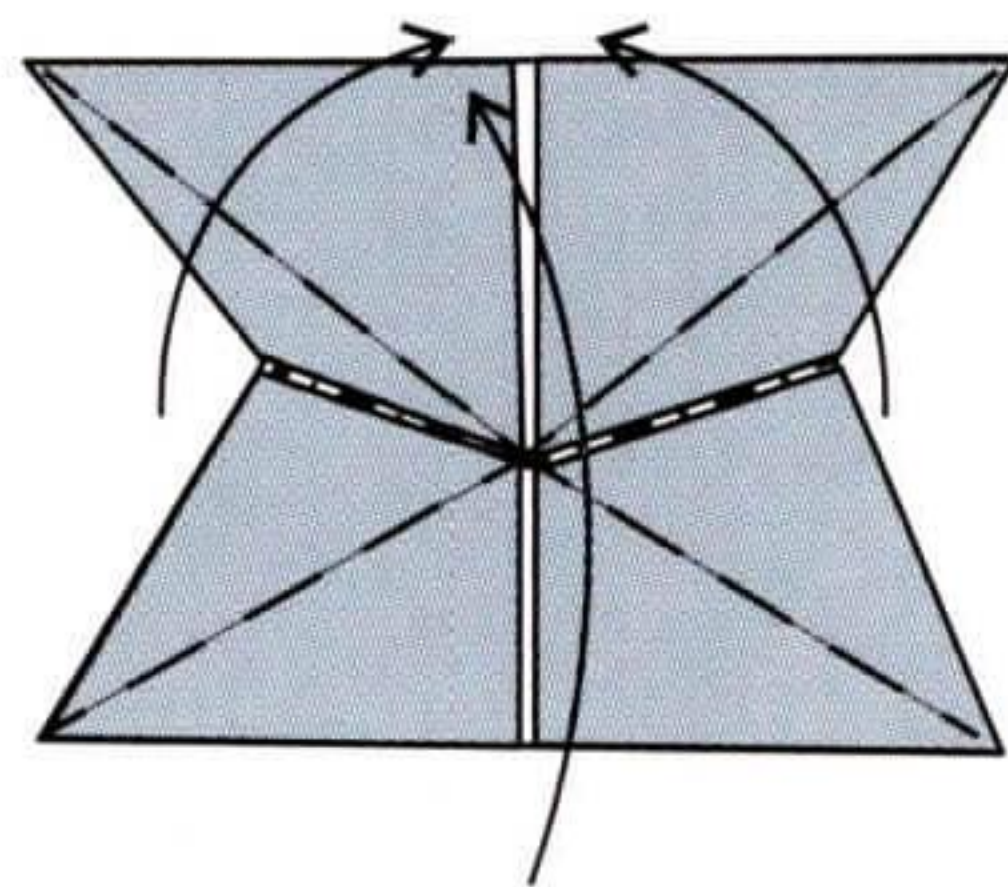

8 Fold in progress.

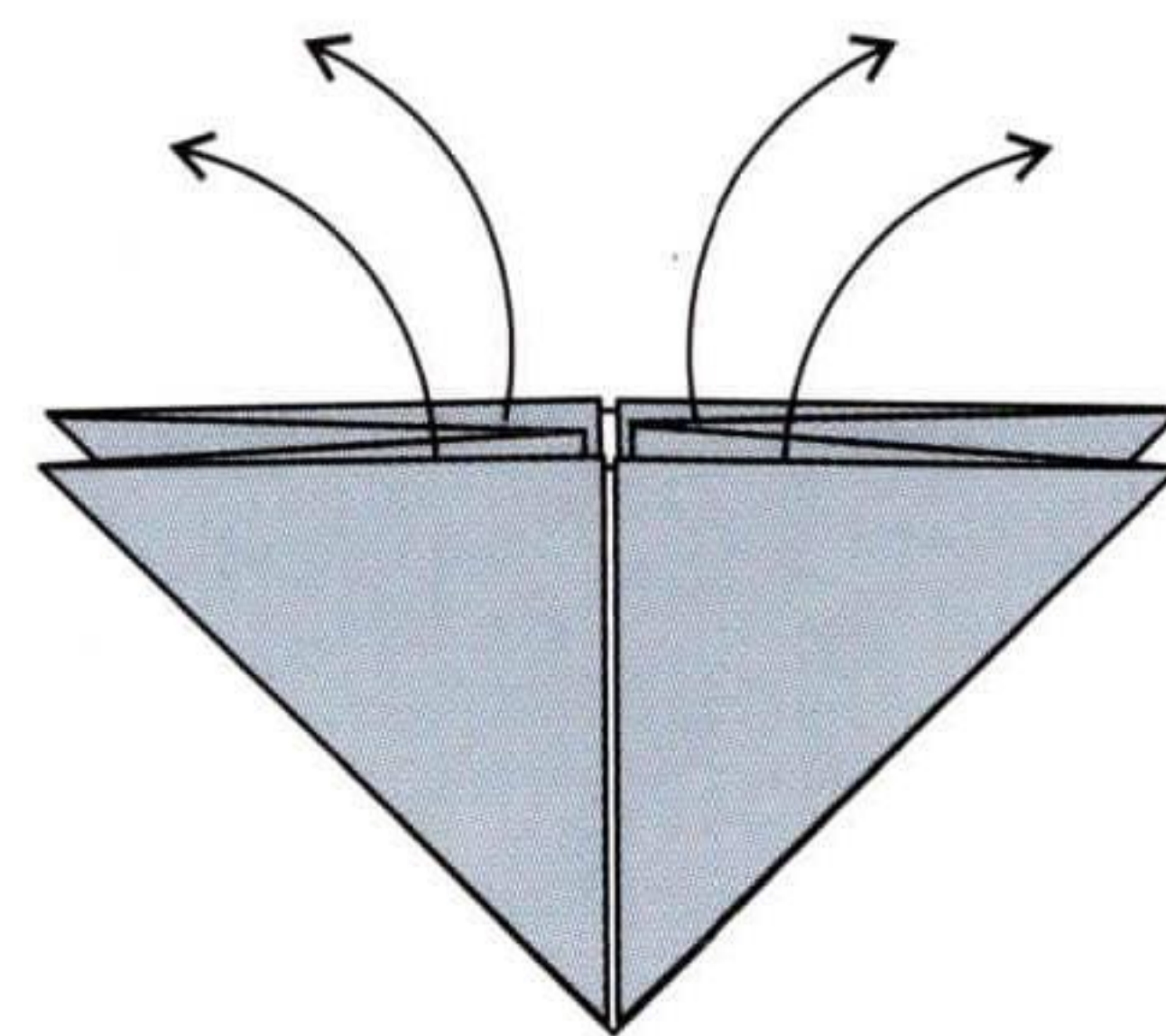

9 Reverse out the trapped paper from the inside of the folded corners.

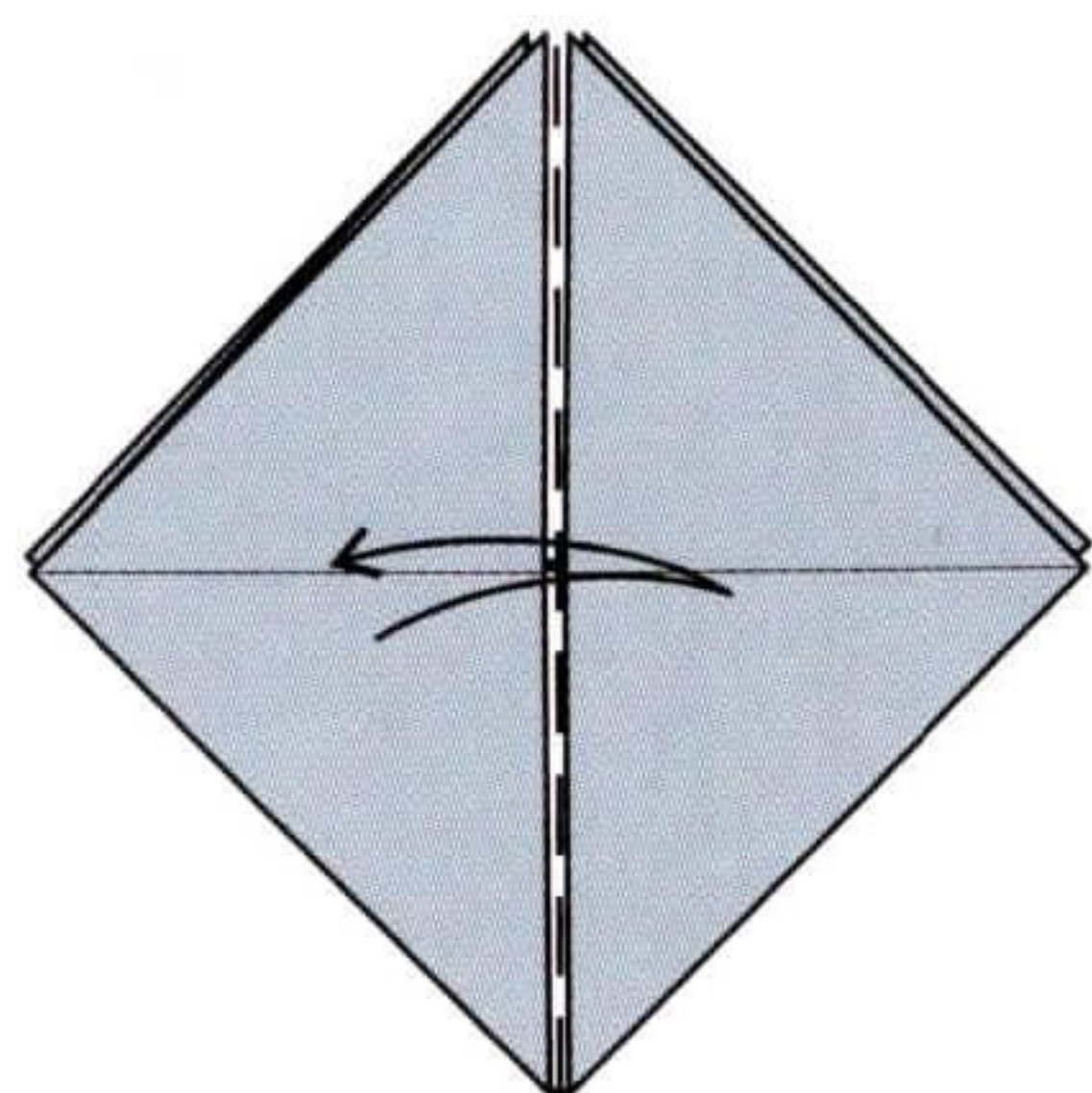

10 Fold the model in half and then unfold.

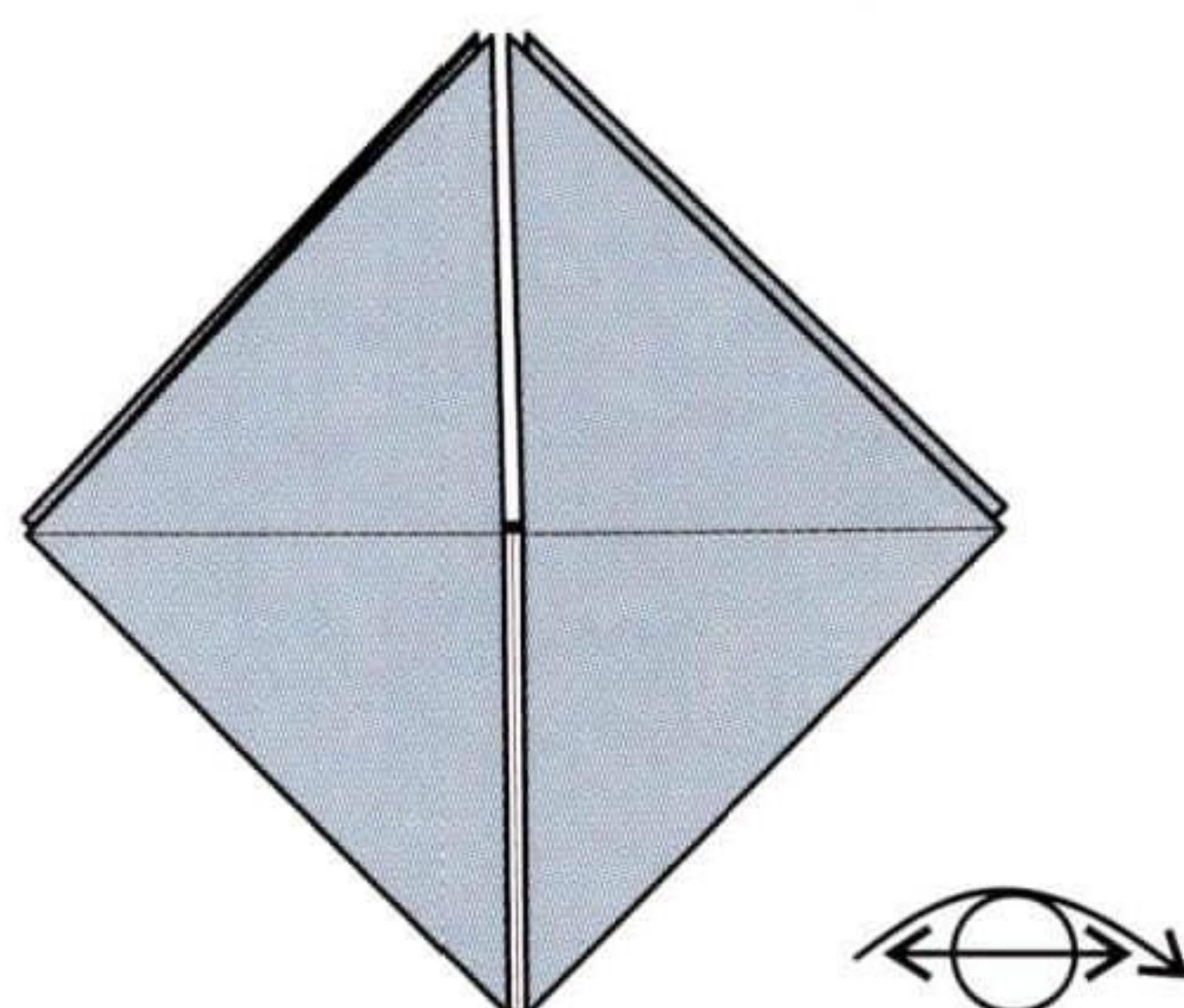

11 Turn the model over left to right.

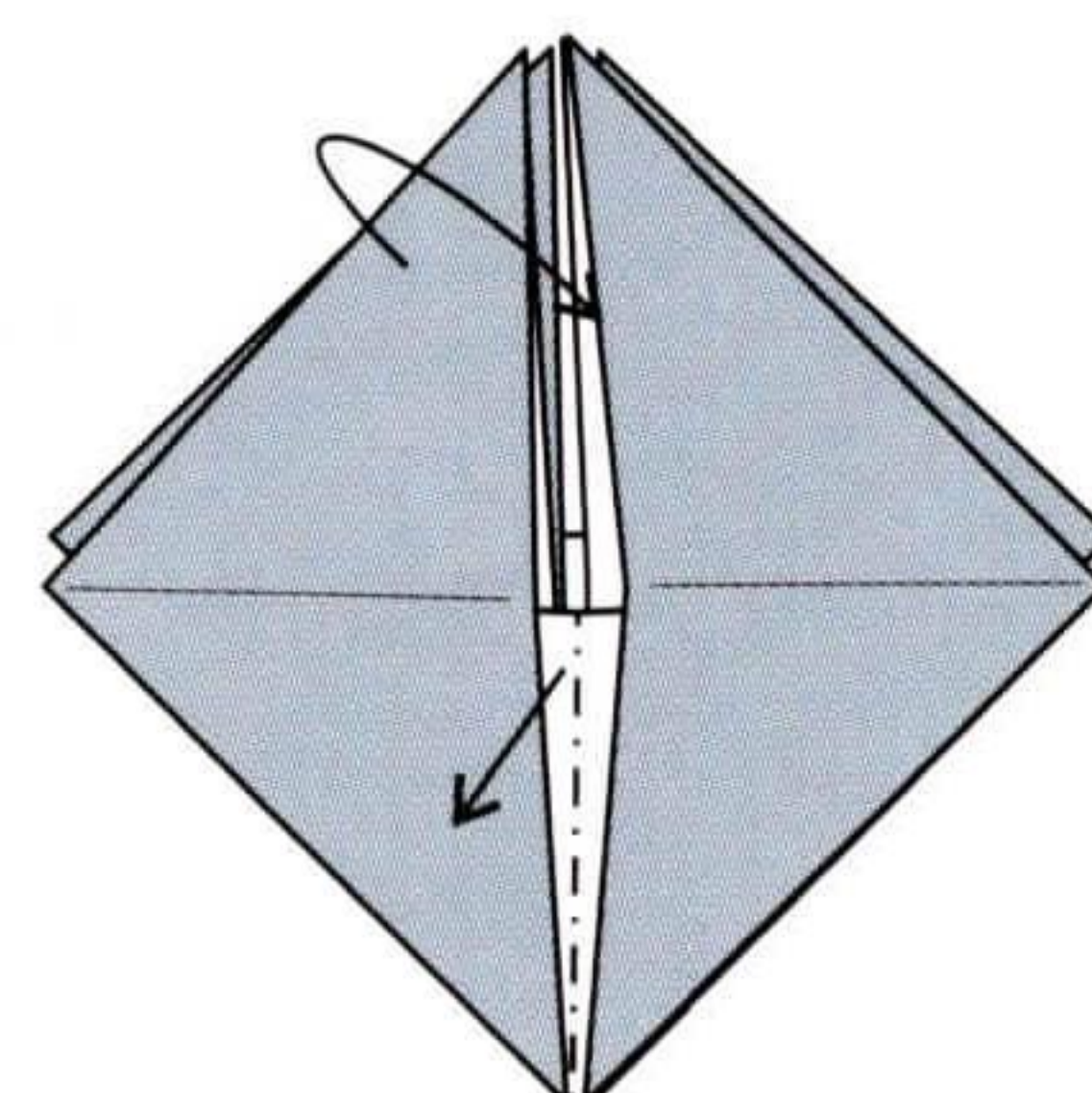

12 Fold out the inner edge. This will open out the adjacent paper into a 3D shape.

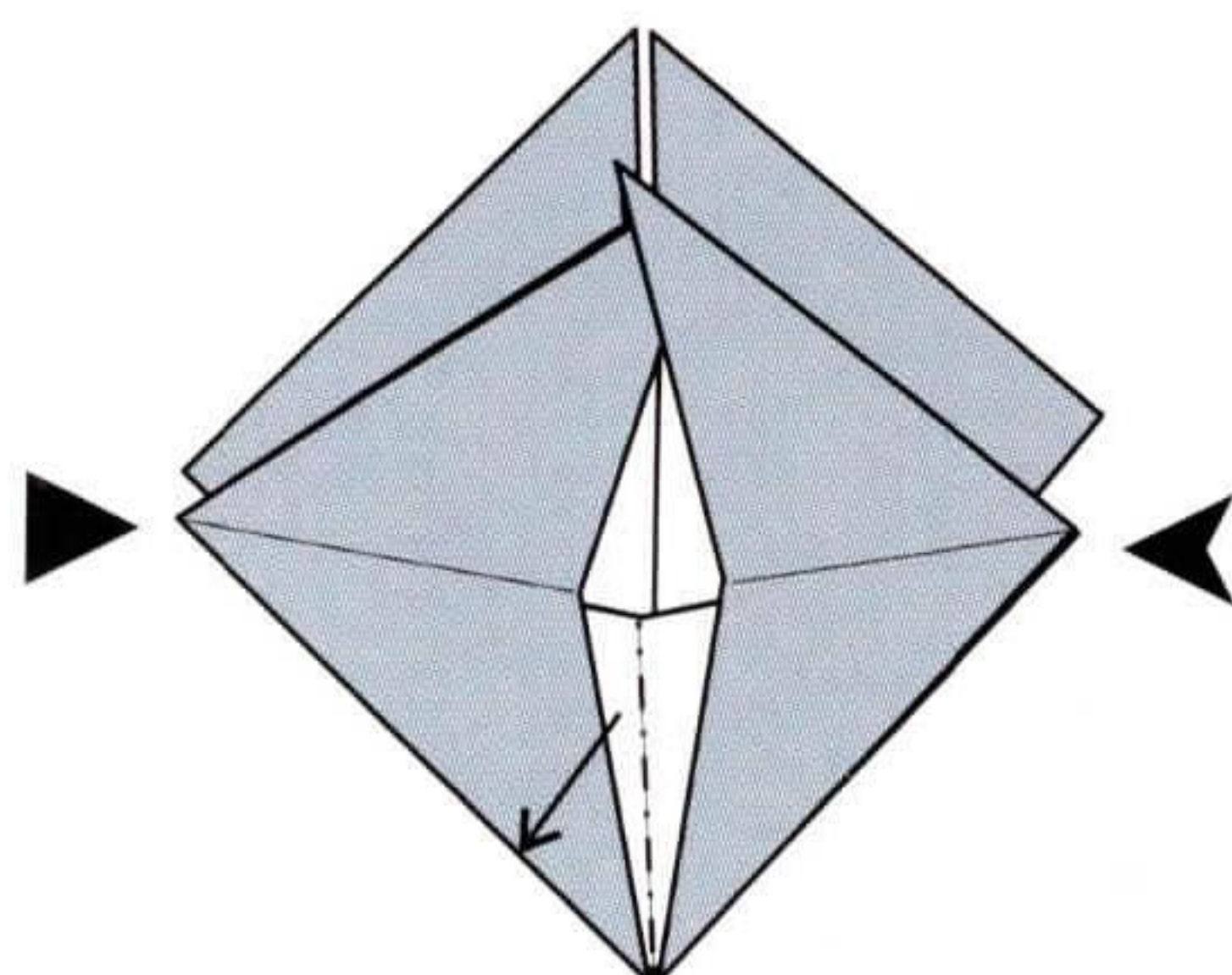

13 Push the sides together and tuck one side into the other.

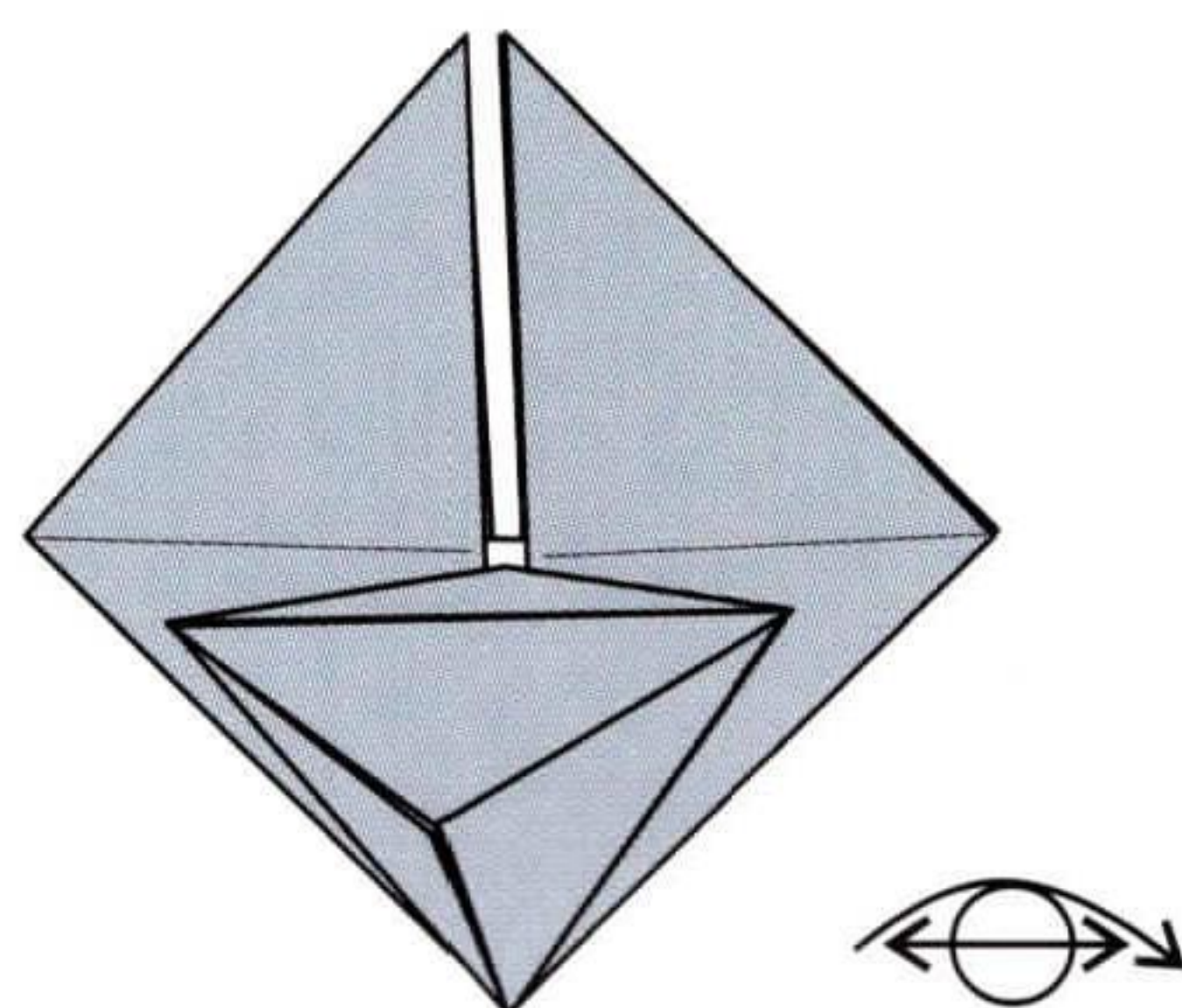

14 The assembled sections will form a hexahedron. Then turn the model over left to right.

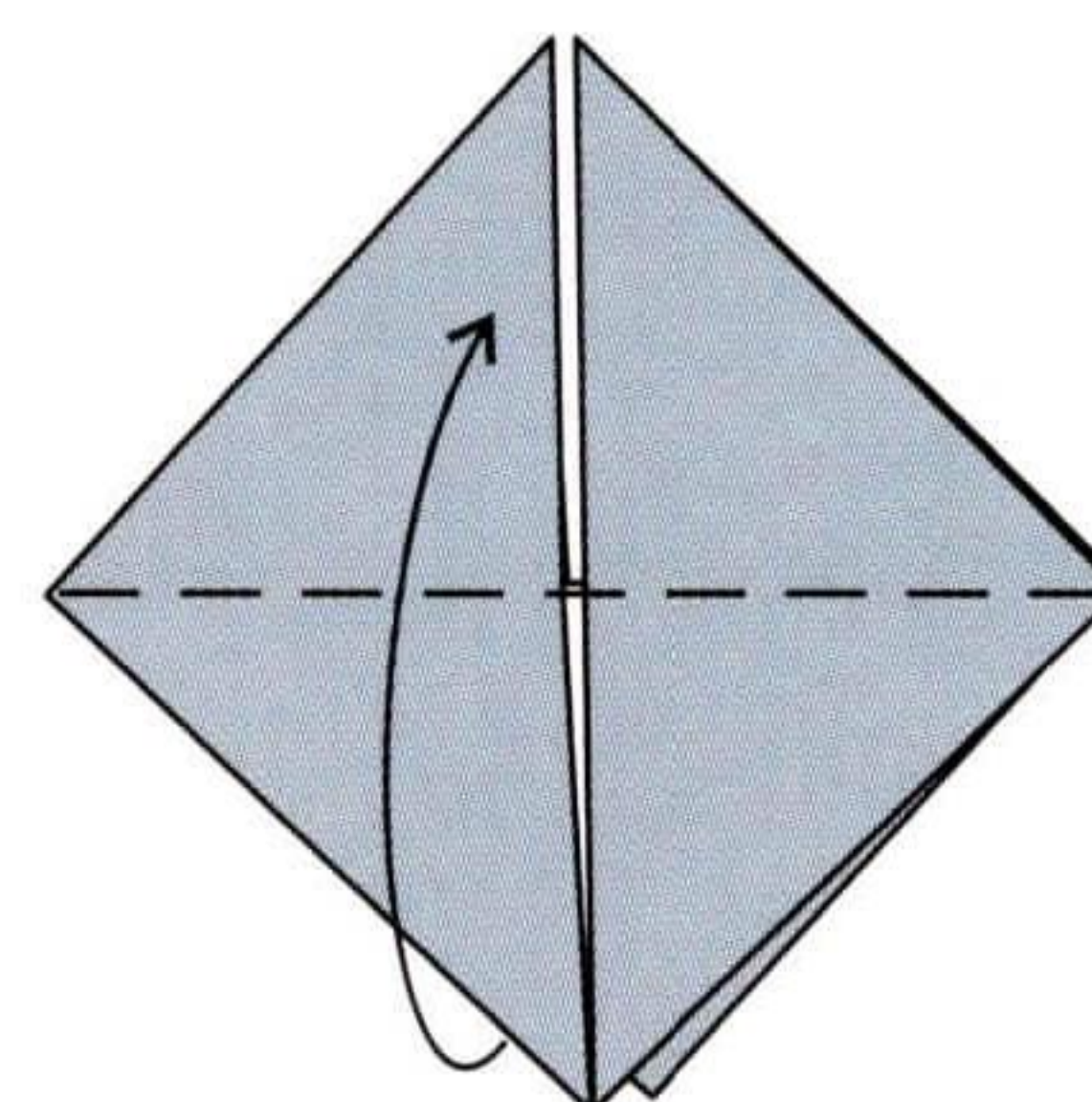

15 Fold the corner up.

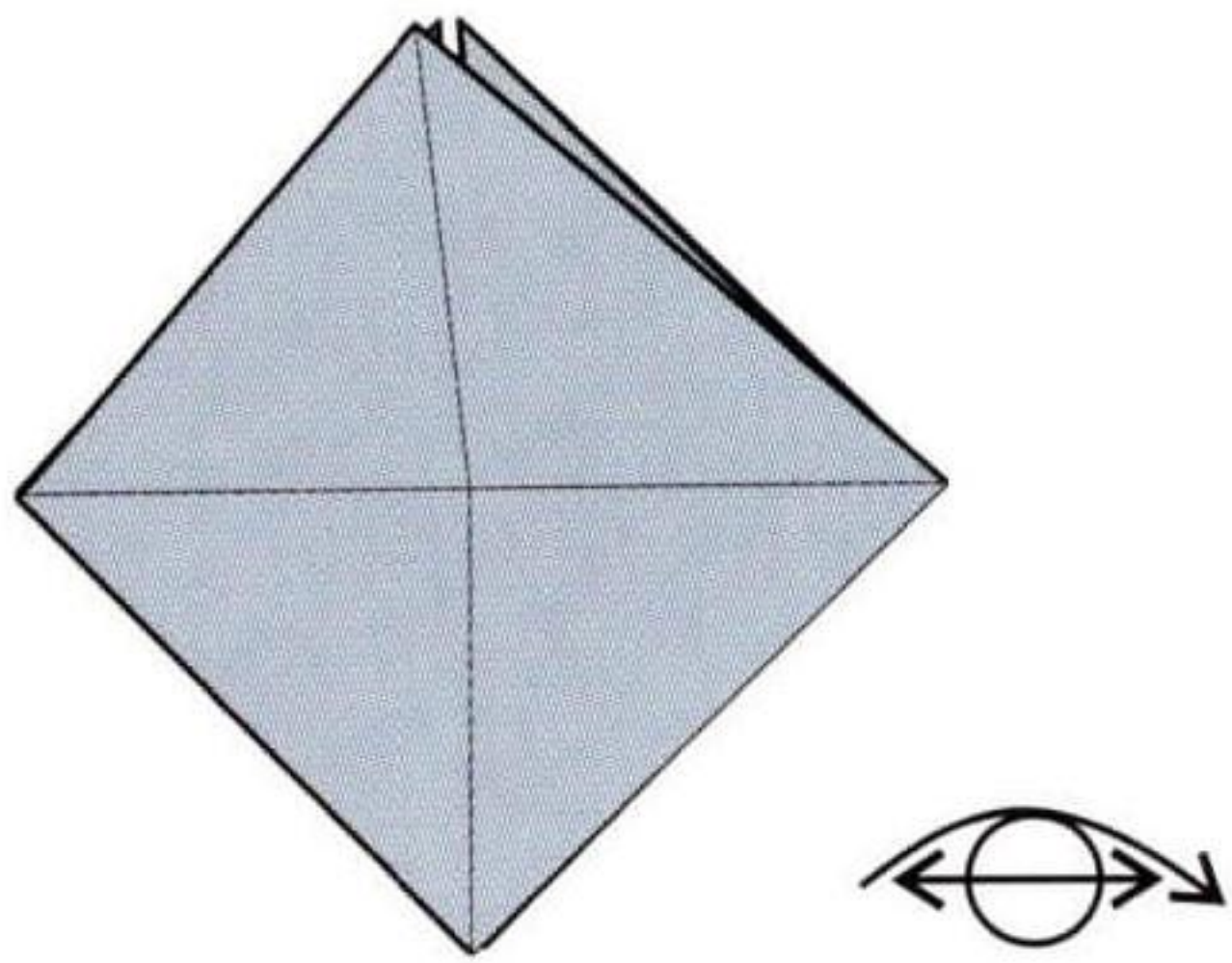

16 Turn the model over left to right.

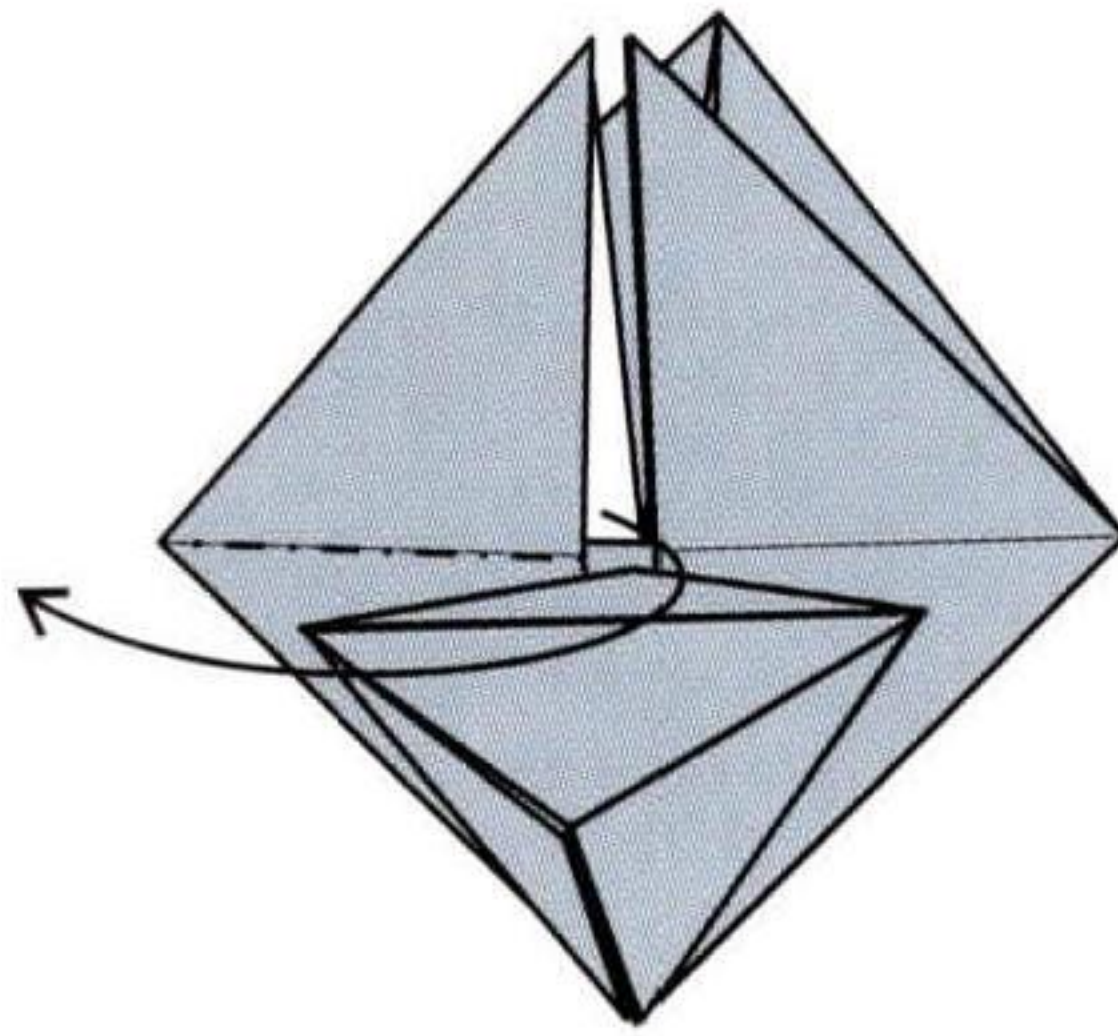

17 Pull out the adjacent edge and open it out.

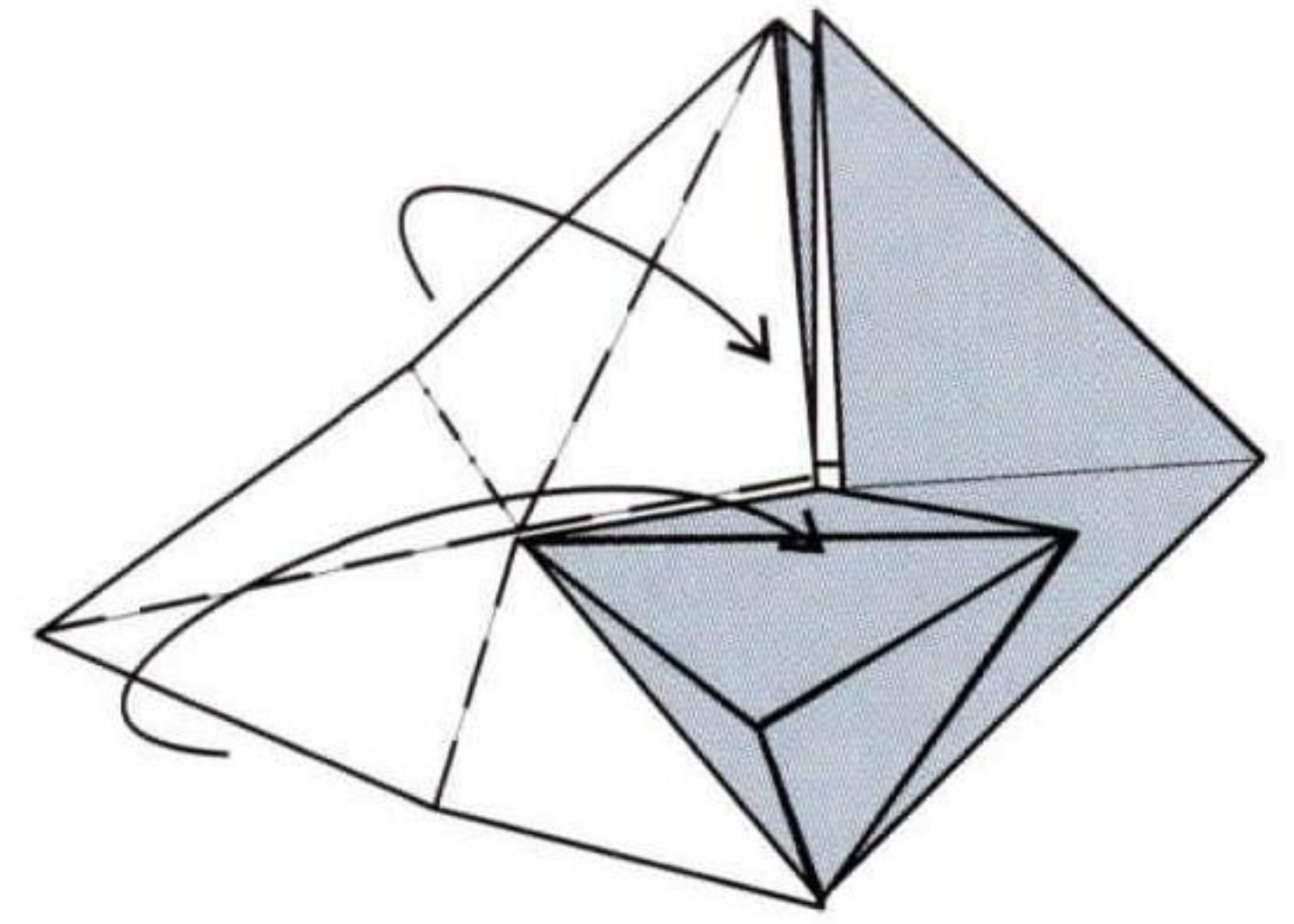

18 Wrap the outer paper around the hexahedron shape.

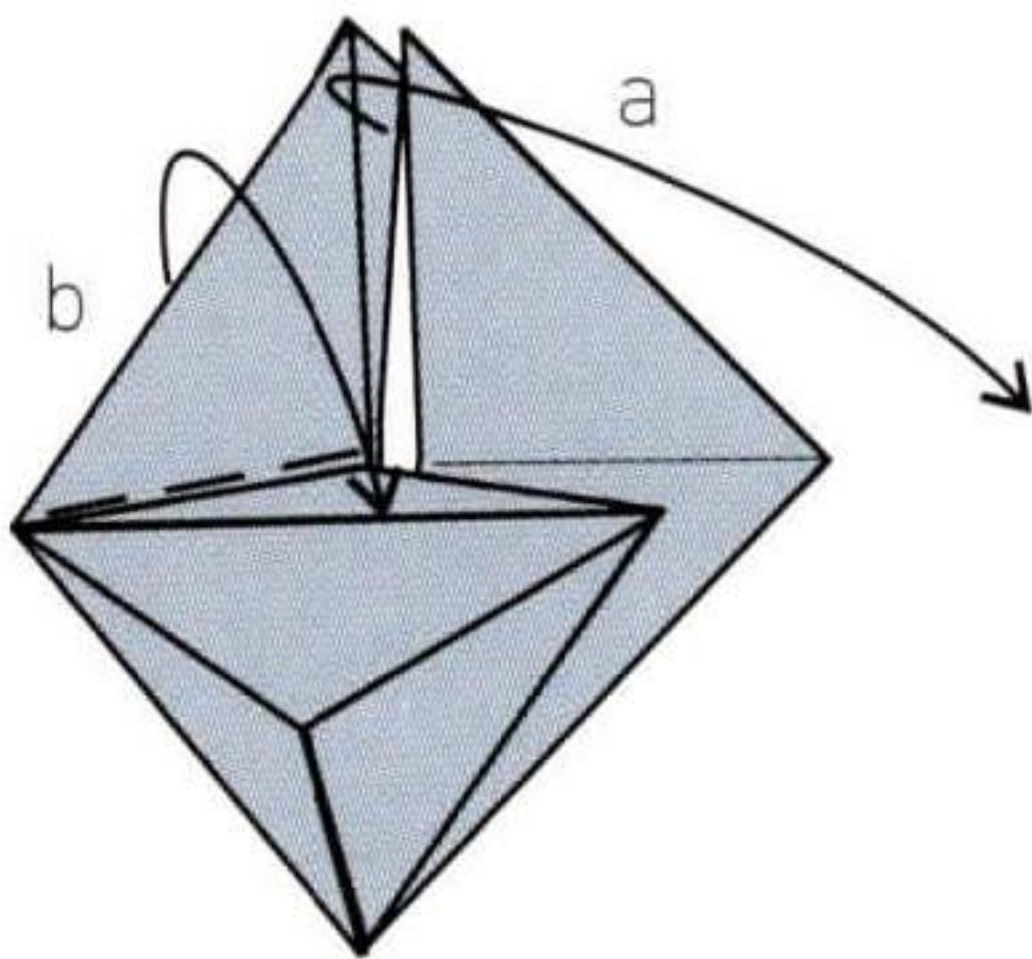

19 Open out the paper by pulling out the corner (a) and continue wrapping the hexahedron shape by folding over at (b).

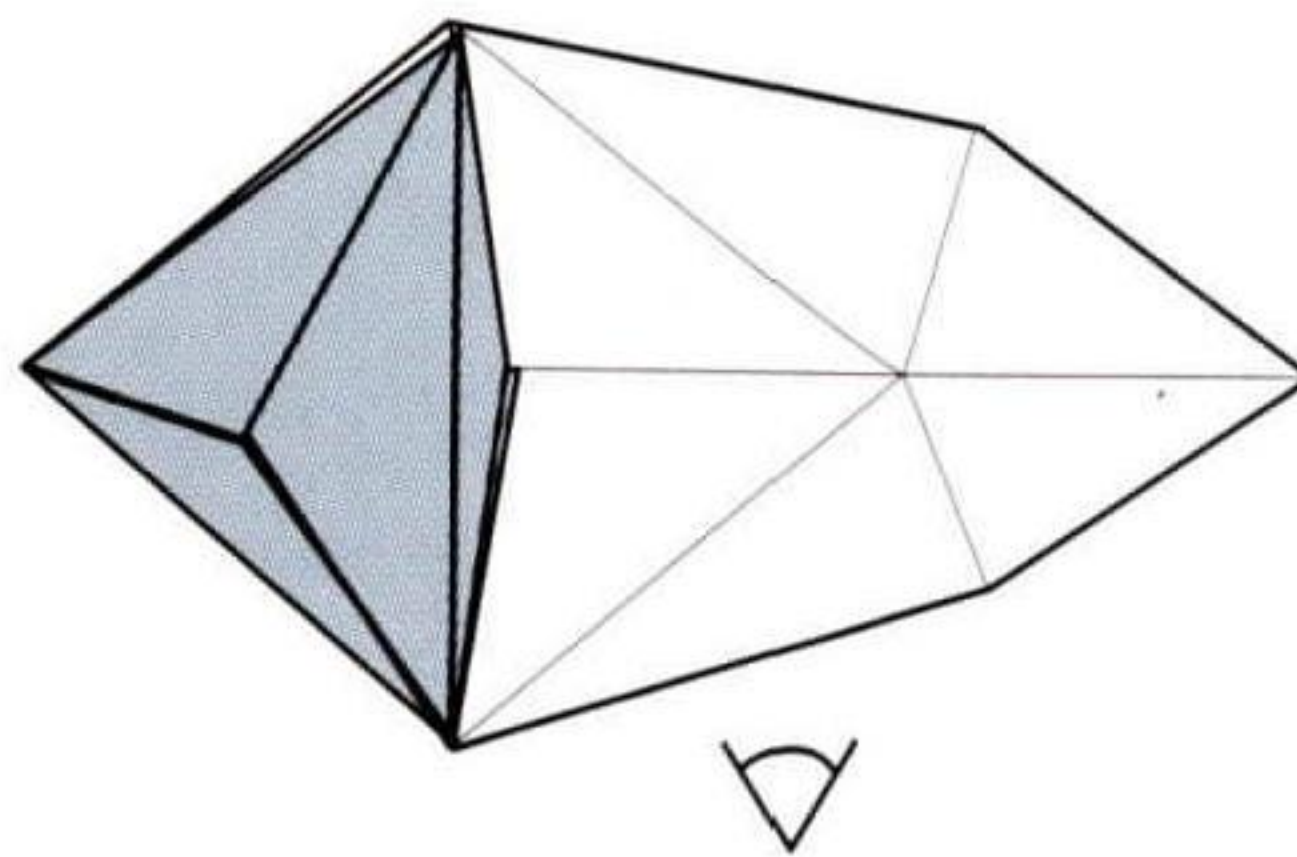

20 Rotate the model slightly and look at the side of the model.

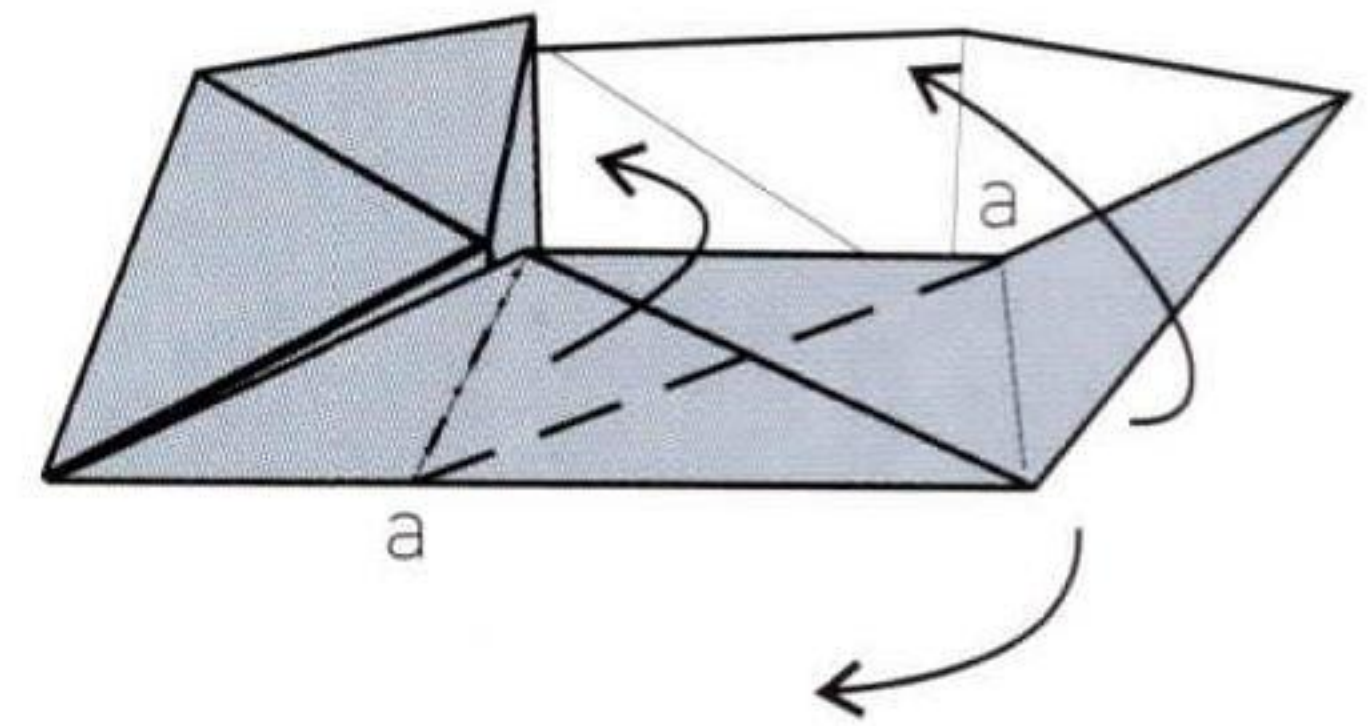

21 Wrap the outer paper around by making a crease along the (a-a) edge.

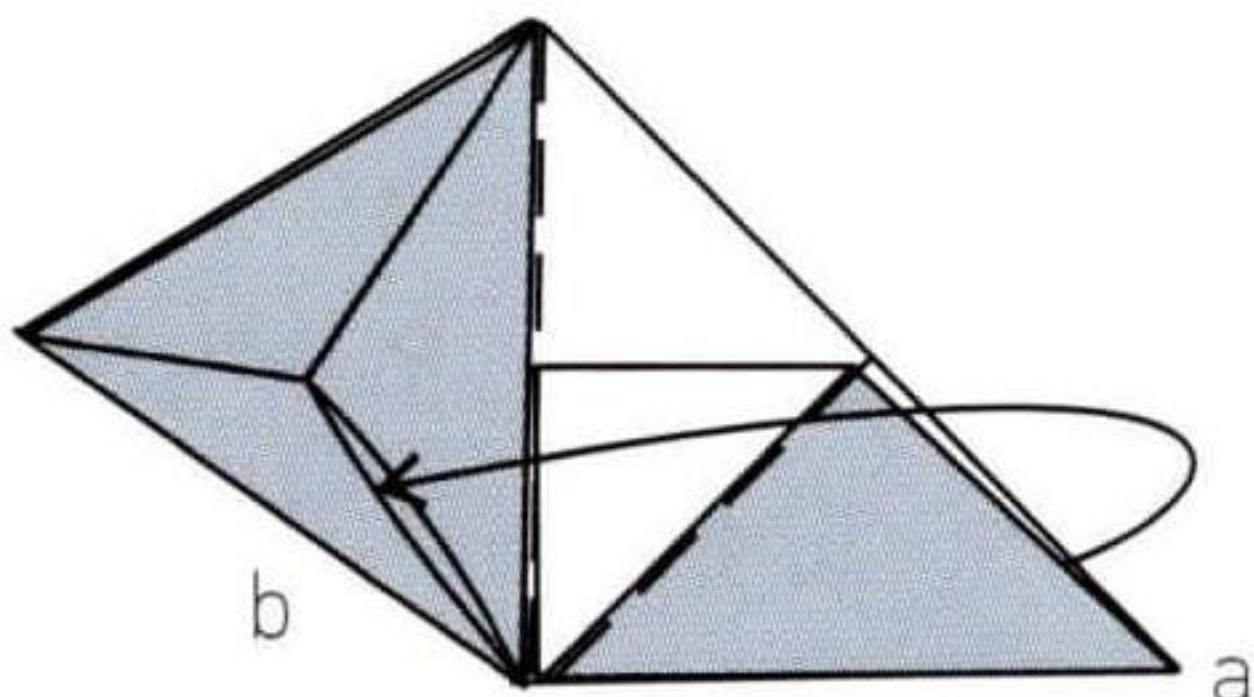

22 Fold the pinched corner up and tuck the point (a) into the pocket (b).

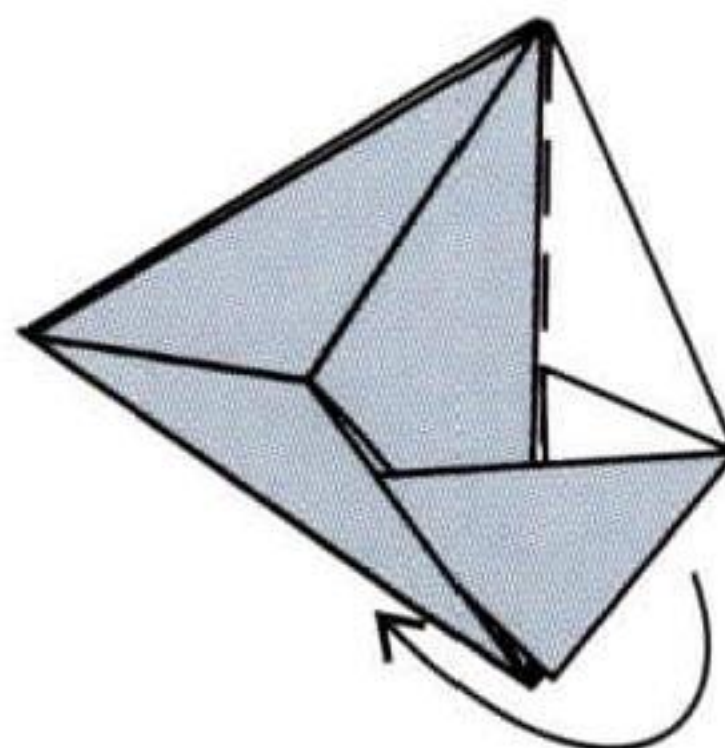

23 Continue tucking the point into the pocket.

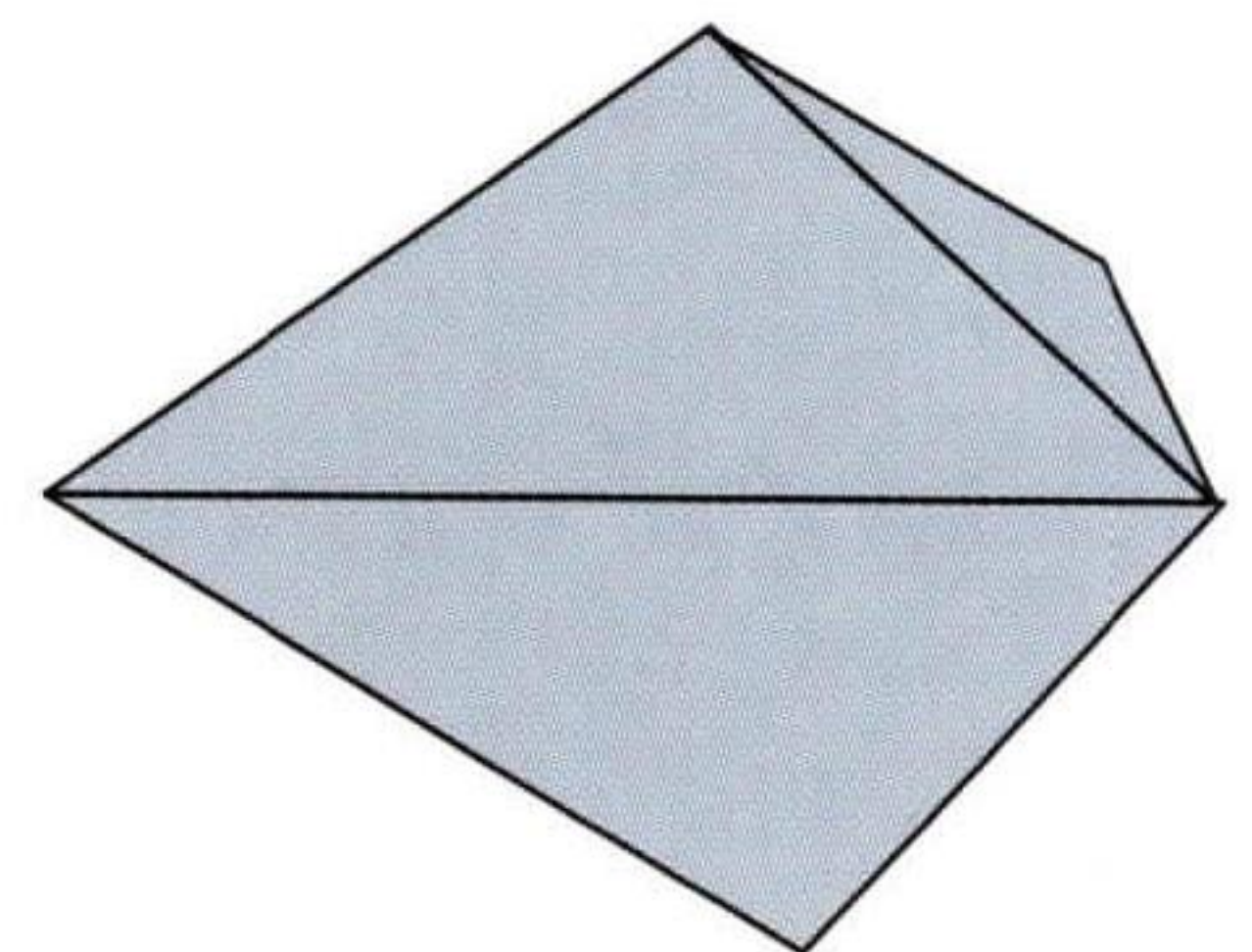

24 Complete.

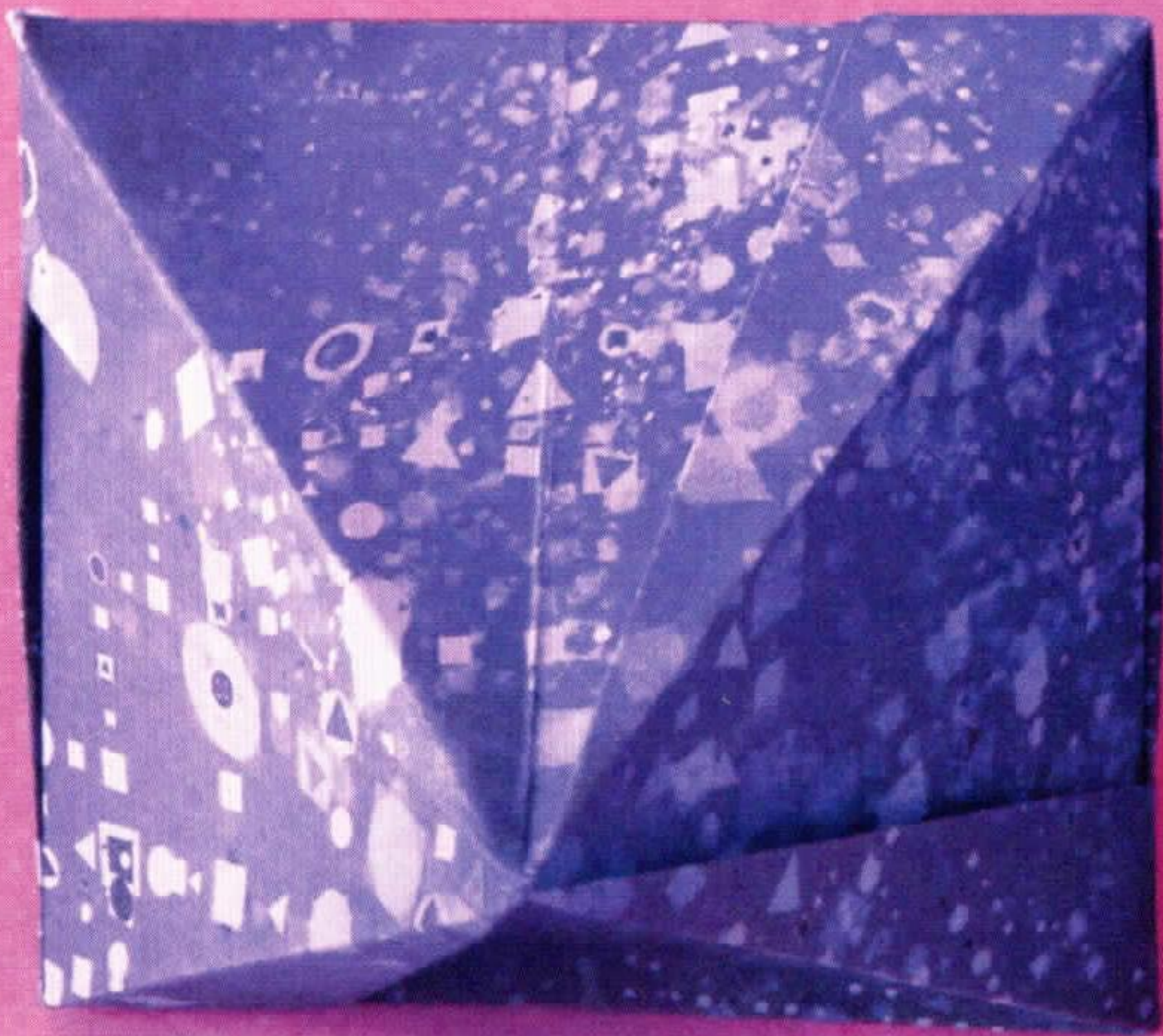

Octahedron One



The octahedron is an eight-sided regular solid constructed from equilateral triangles. It wraps together neatly, with the corners folding into pockets to complete the project.

18 X 18CM (7 X 7IN)

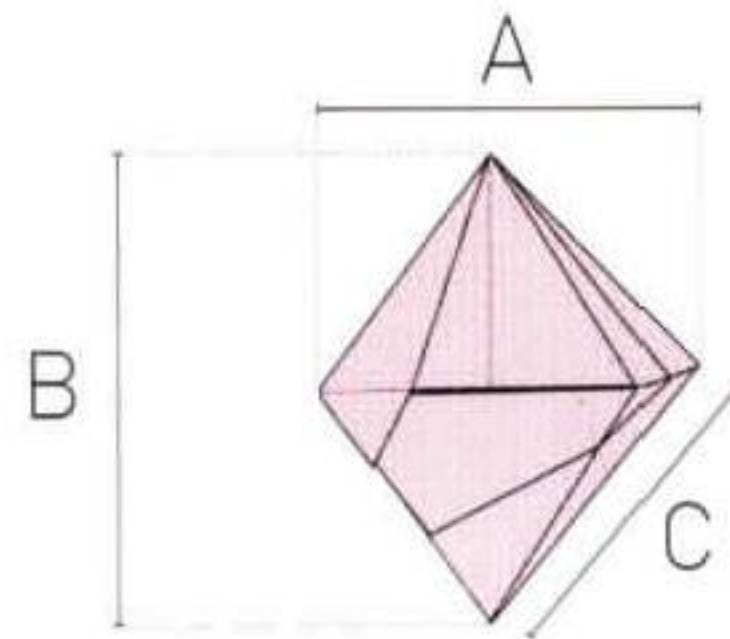
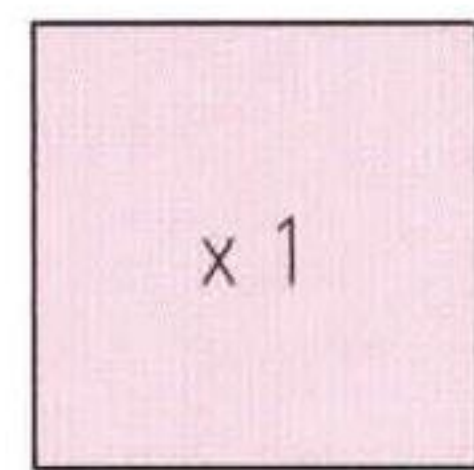

A	5.2cm	(2in)
B	7.6cm	(3in)
C	5.2cm	(2in)

START WITH A SQUARE, COLOURED SIDE UP.

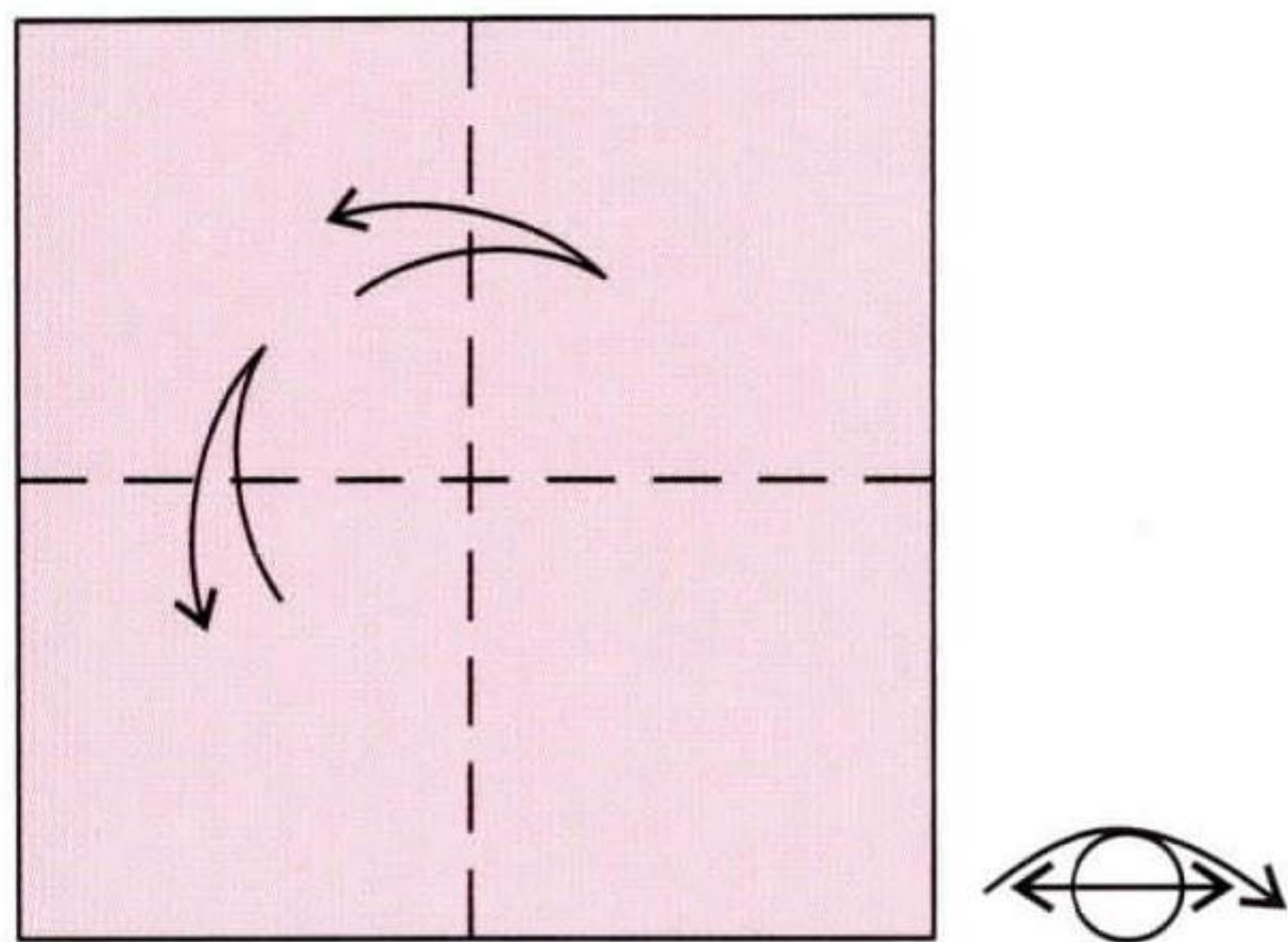

1 Fold and unfold the square in half lengthwise. Then turn the paper over left to right.

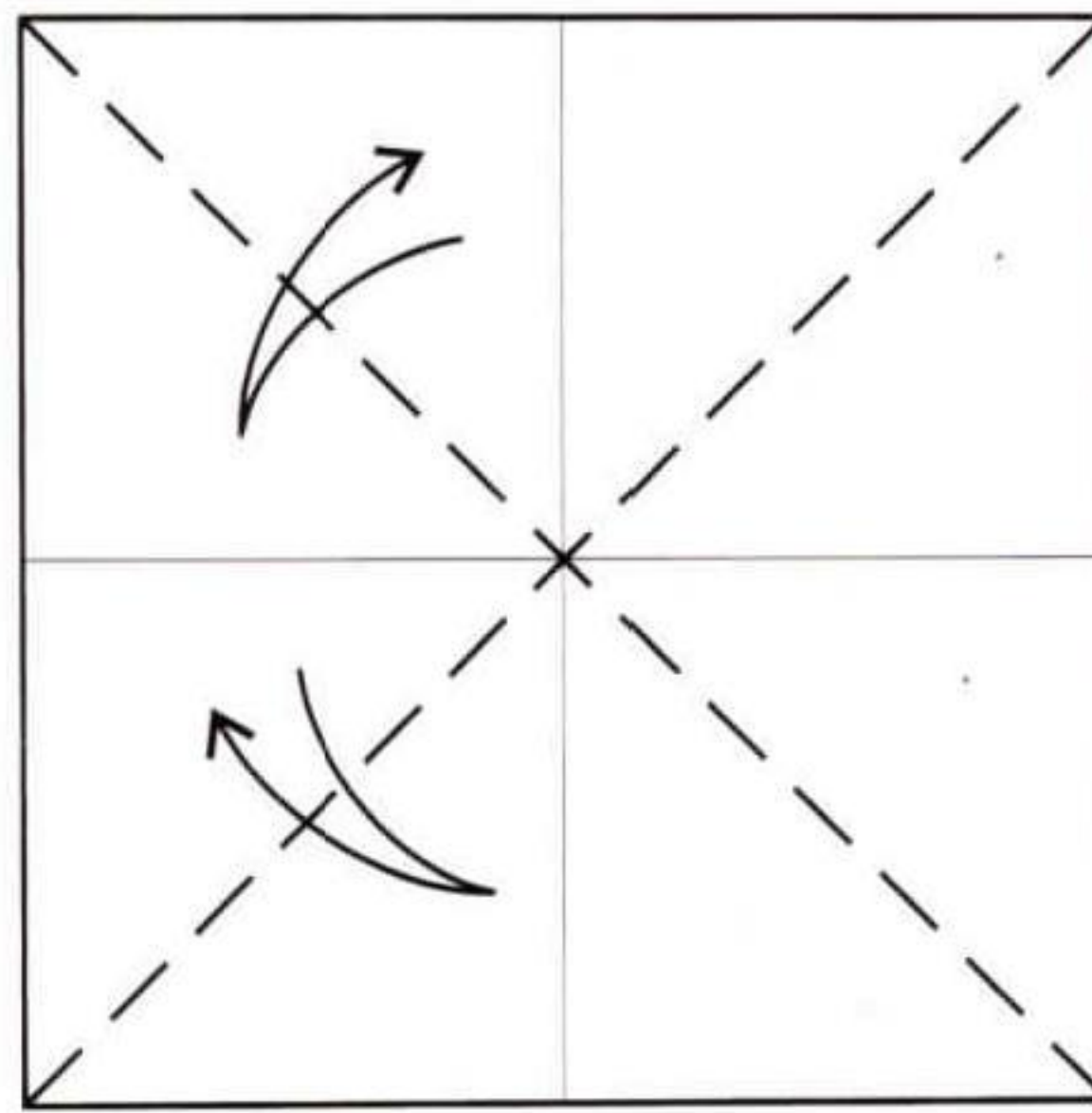

2 Fold and unfold the square diagonally along the middle.

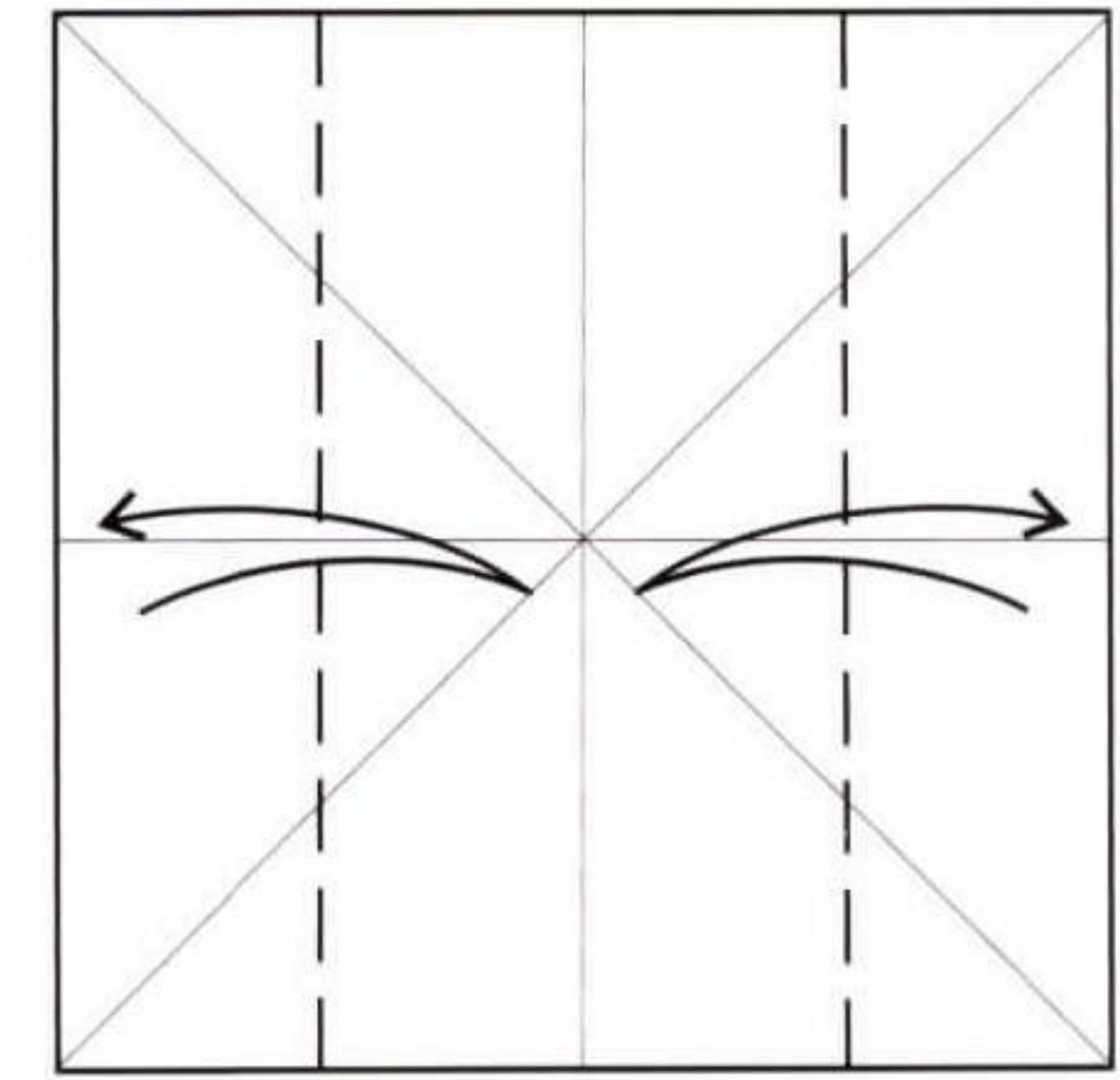

3 Fold and unfold the outer edges to the middle crease.

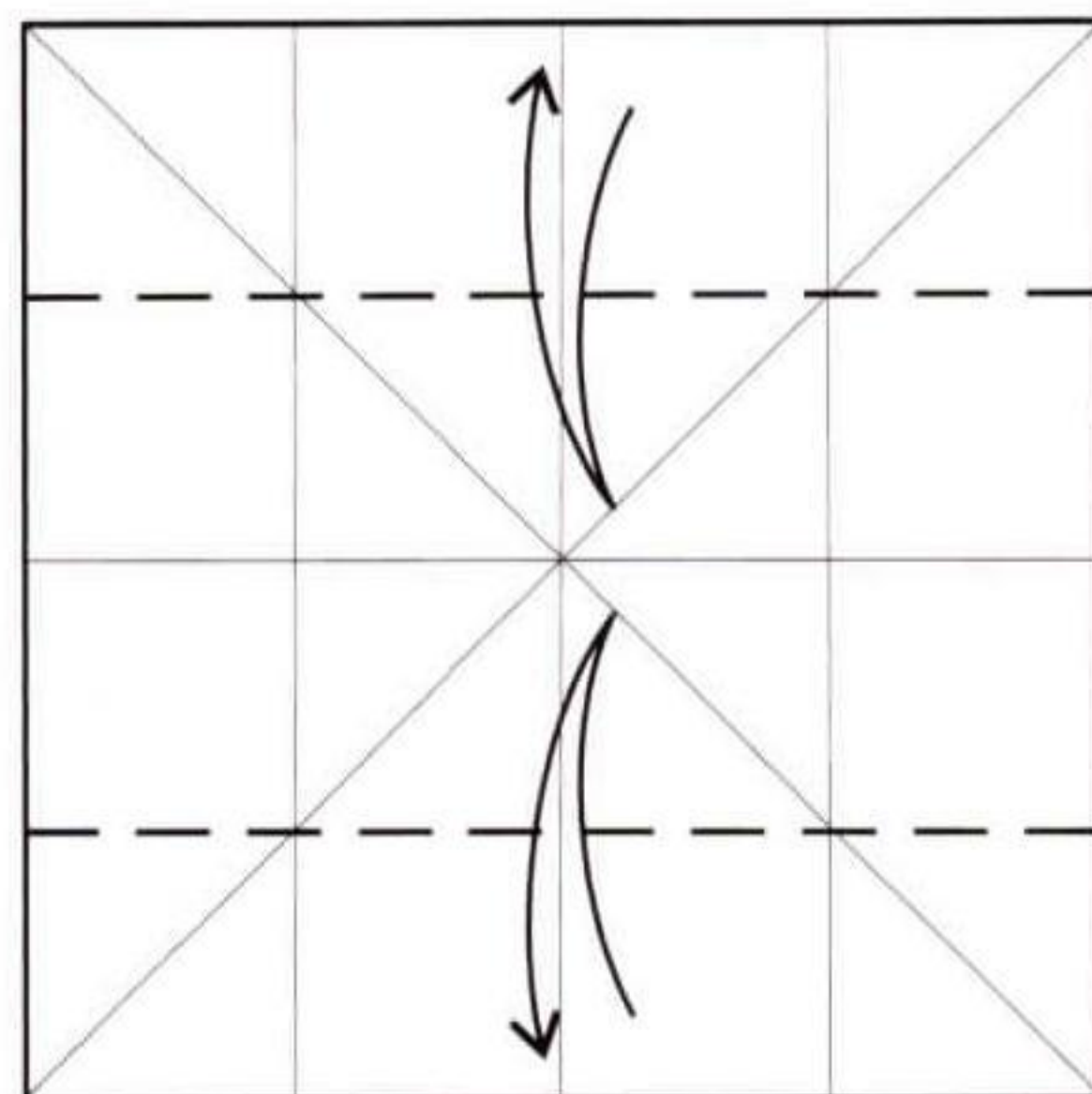

4 Fold and unfold the upper and lower edges to the middle crease.

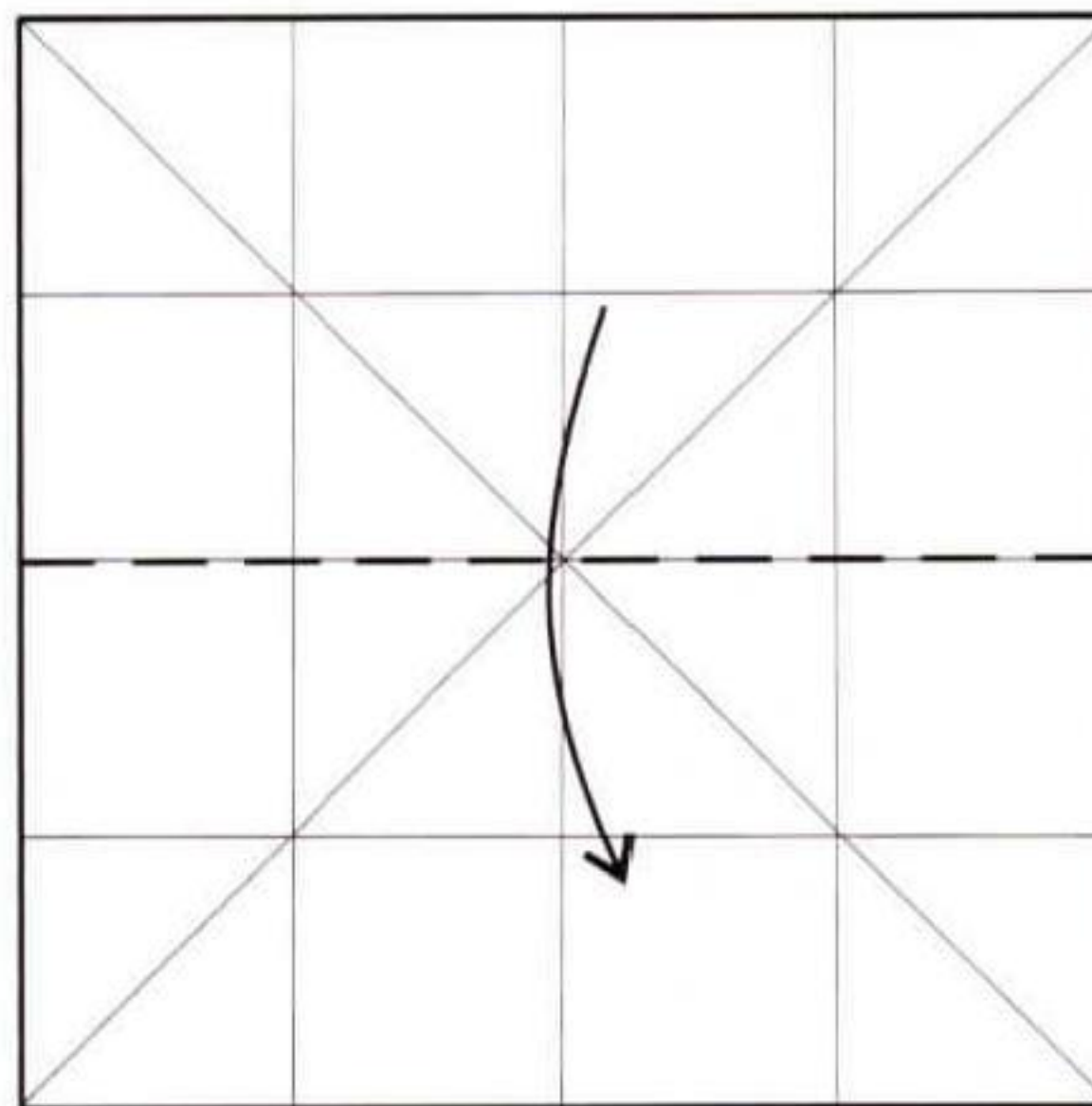

5 Fold the paper in half so that the upper edge touches the lower edge.

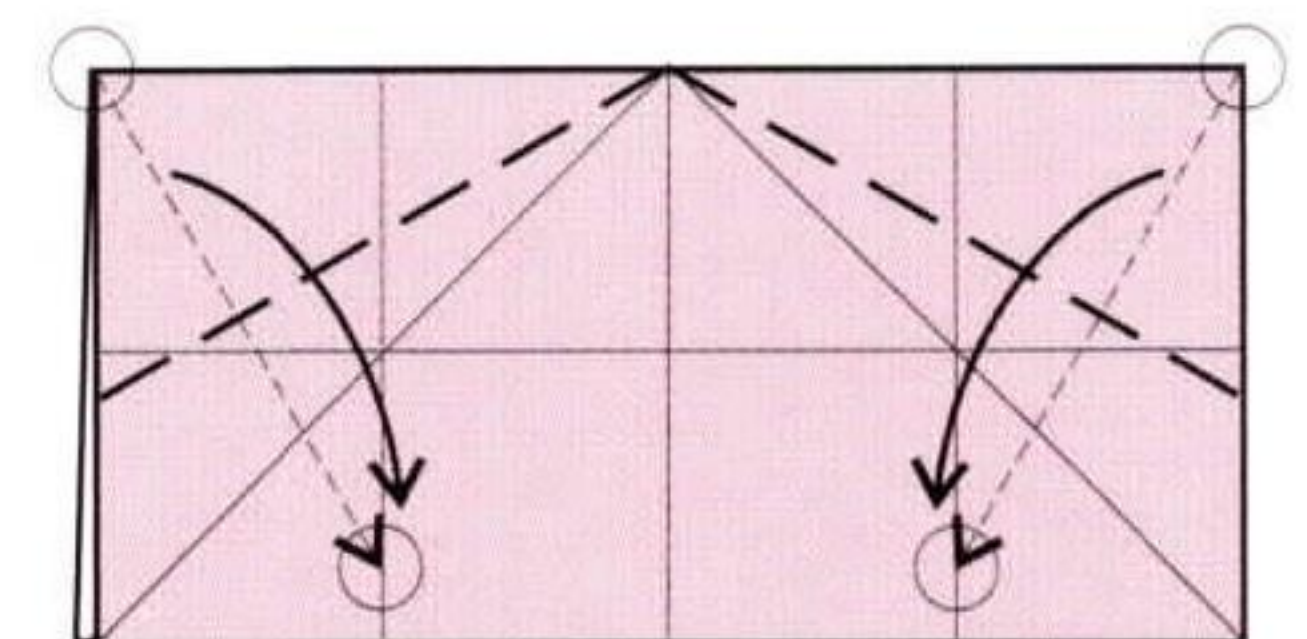

6 Fold the corners in, causing the outer corner to touch the vertical creases.

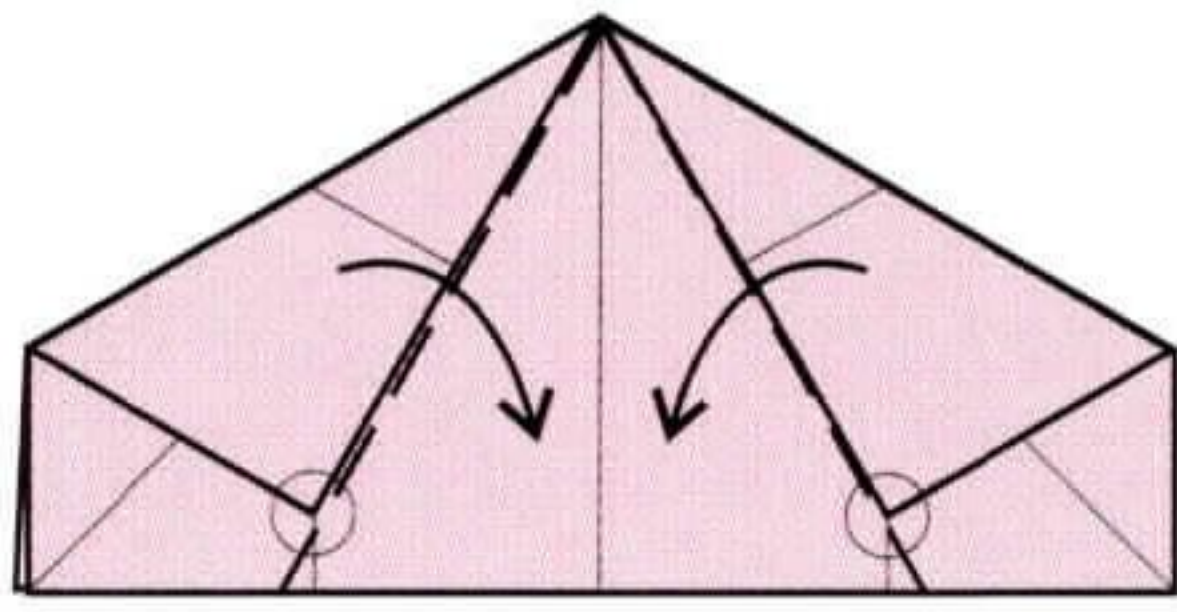

7 Fold the sides in again, along the folded edges.

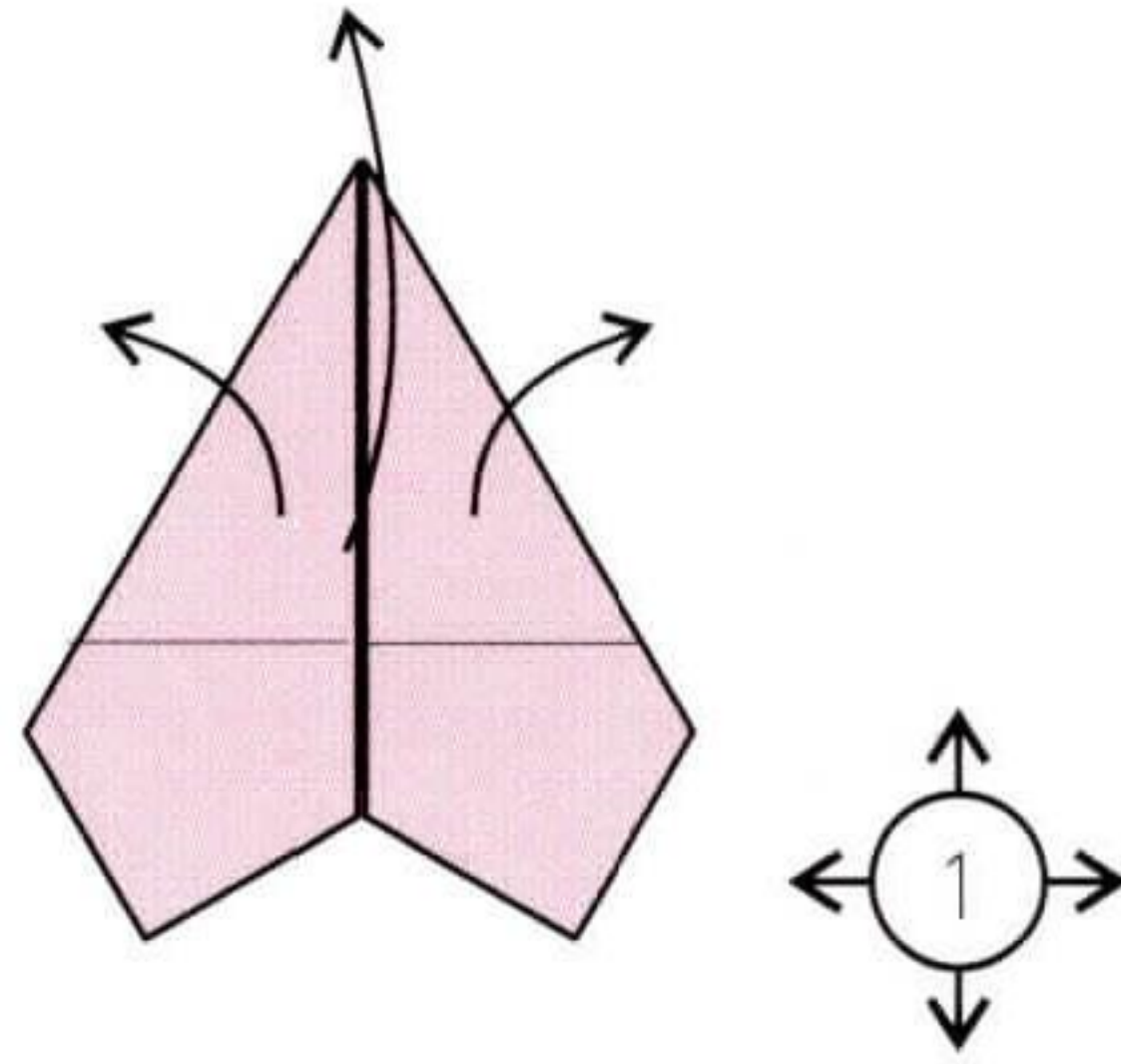

8 Unfold the paper back to a square.

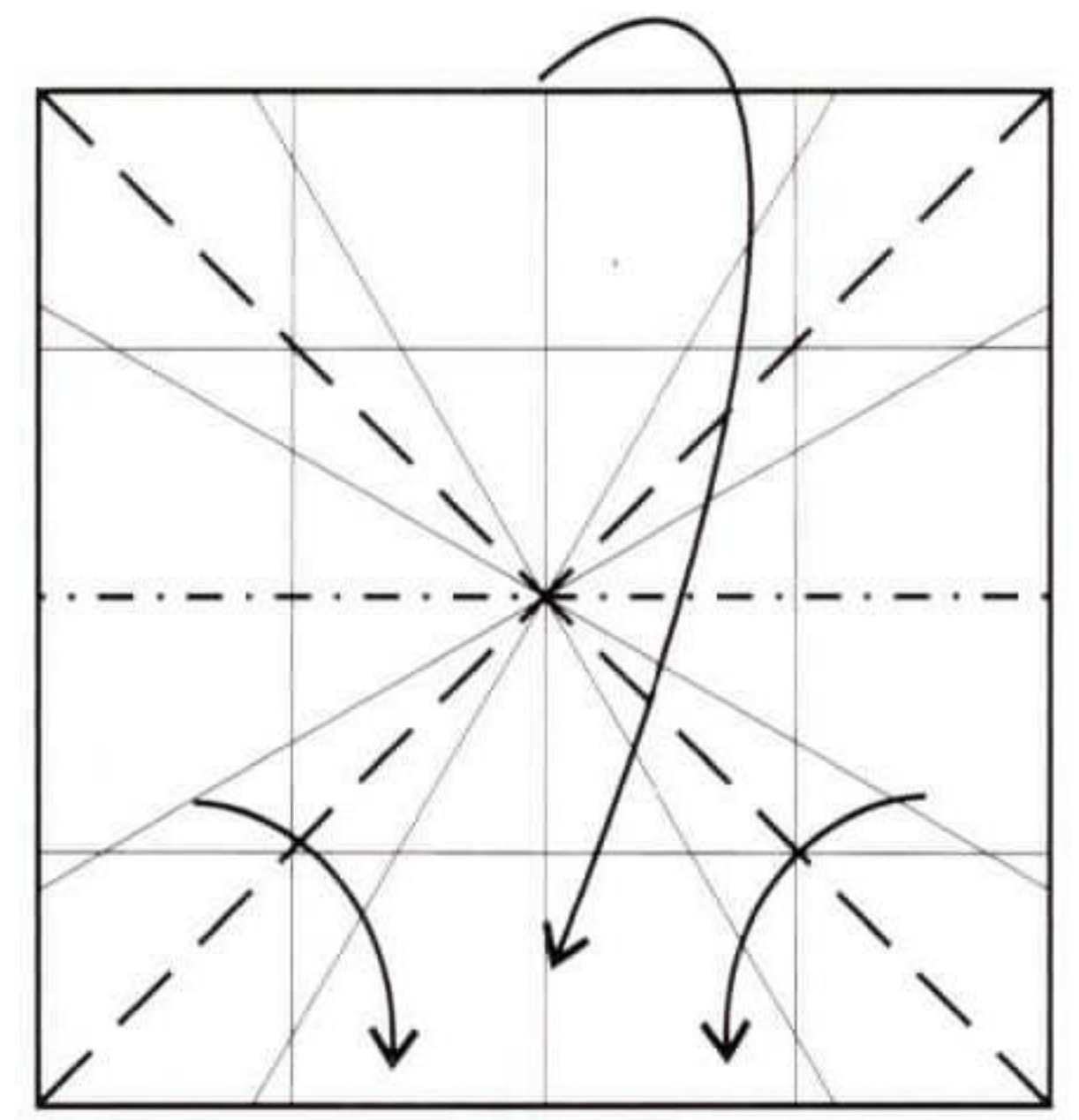

9 Fold the upper section down and the sides in to make a waterbomb base.

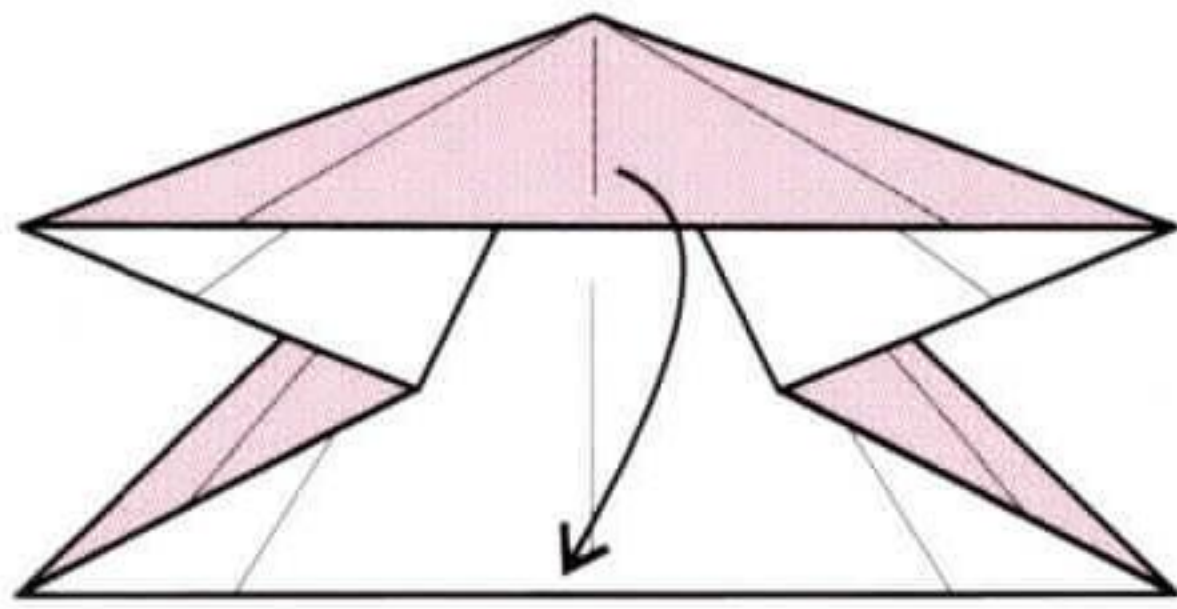

10 Fold in progress.

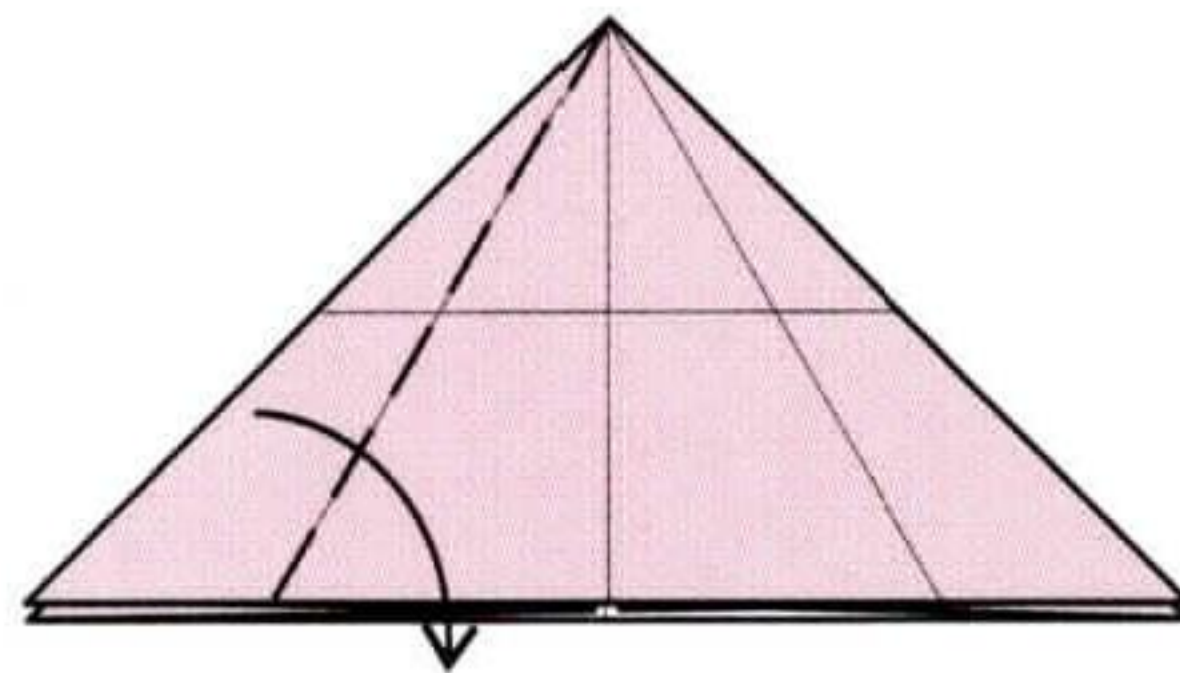

11 Fold one side in along the crease made previously.

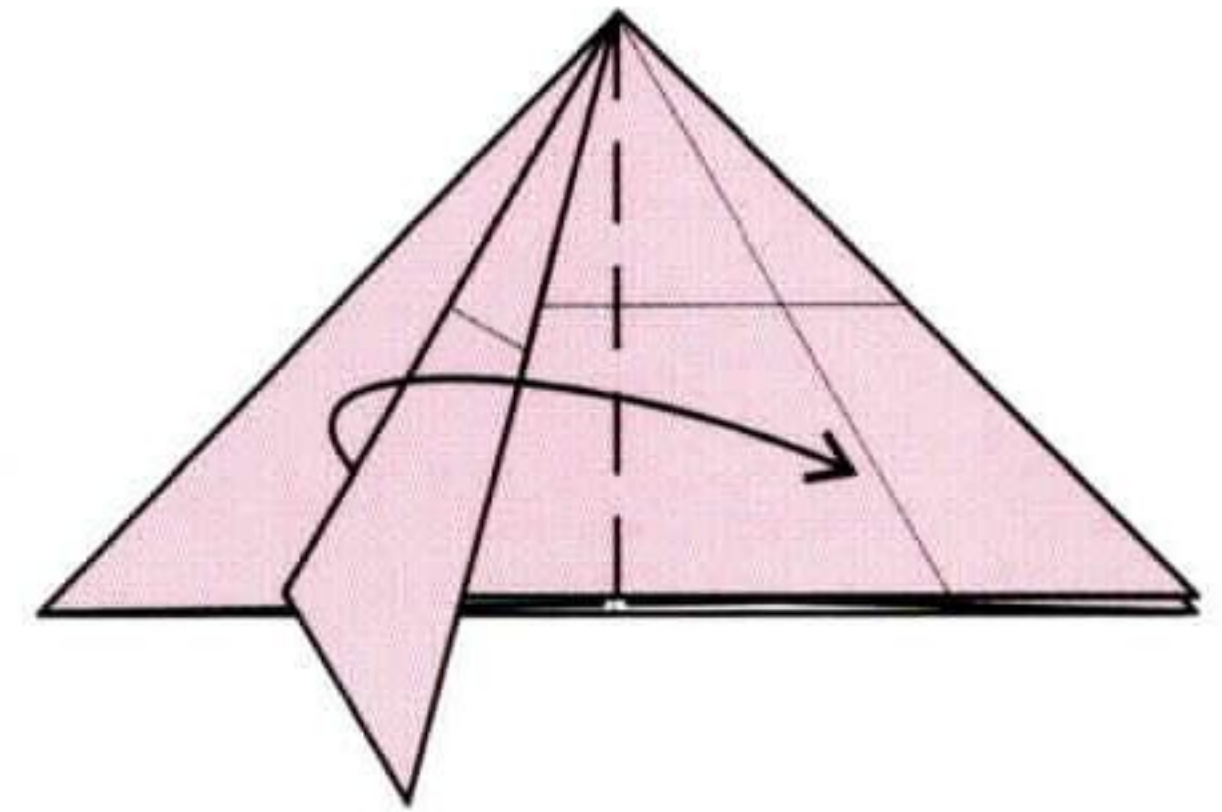

12 Fold one side over to the right.

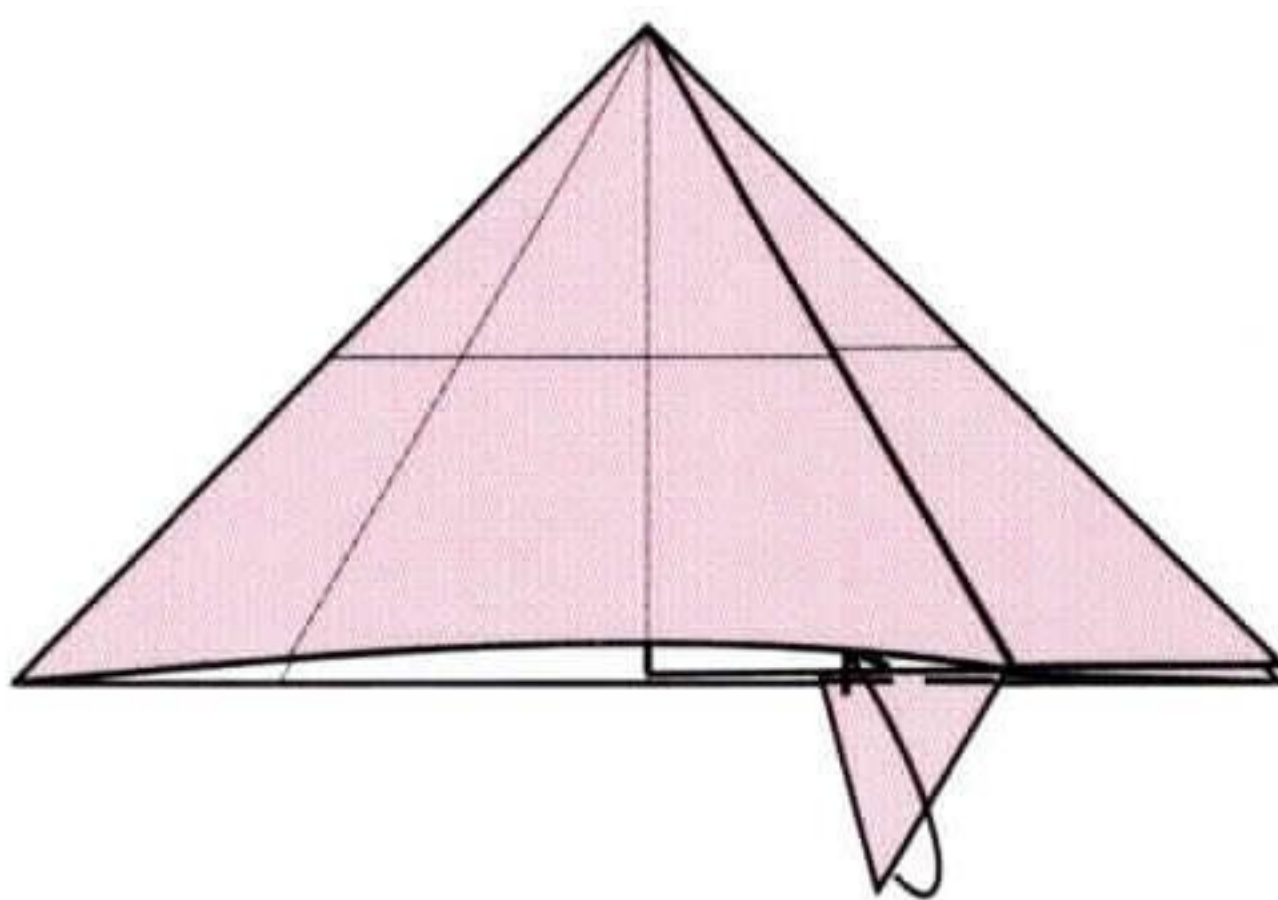

13 Fold the corner up into the pocket formed by the layers of the upper section.

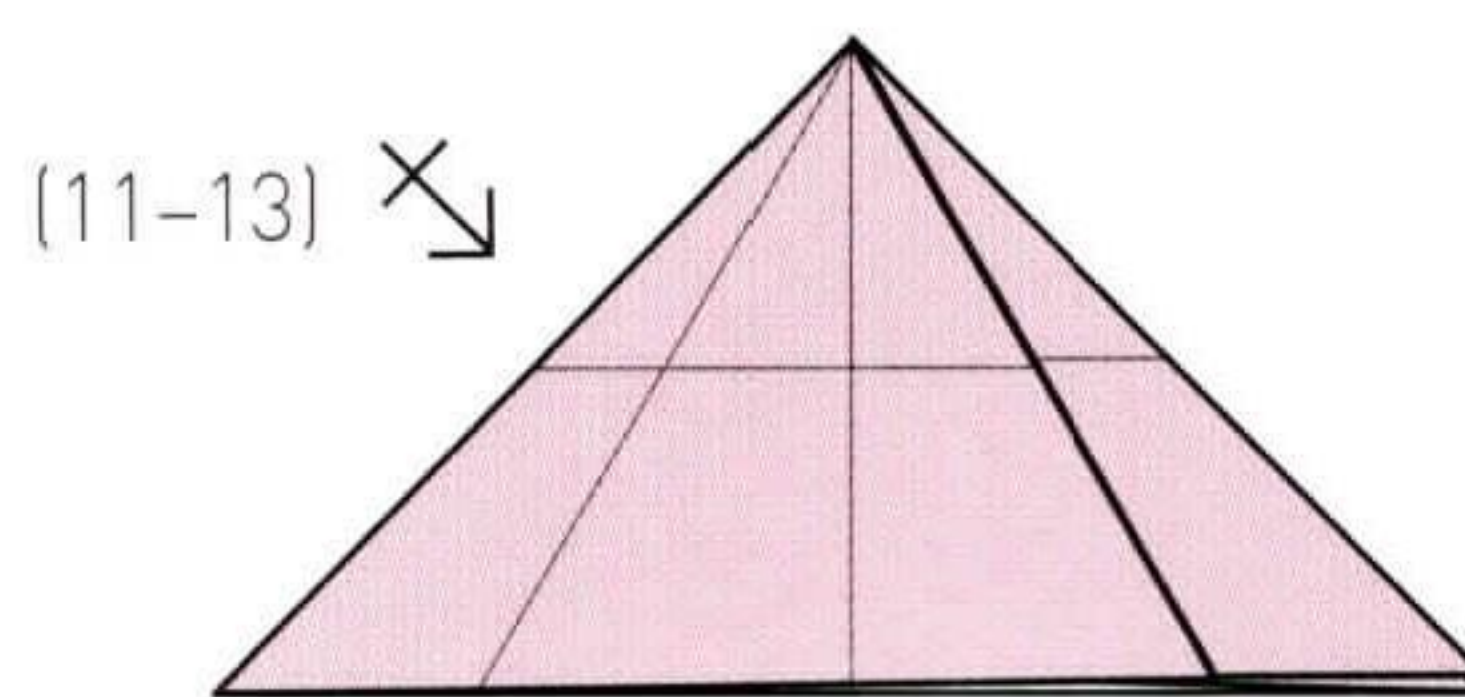

14 Repeat steps 11 to 13 on the other side of the model.

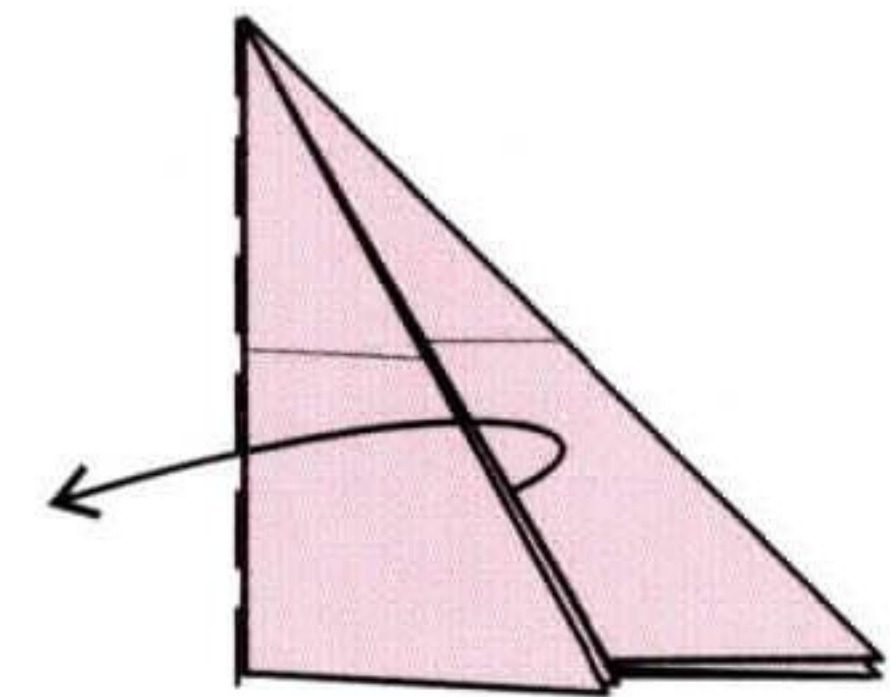

15 Fold the corner back again.

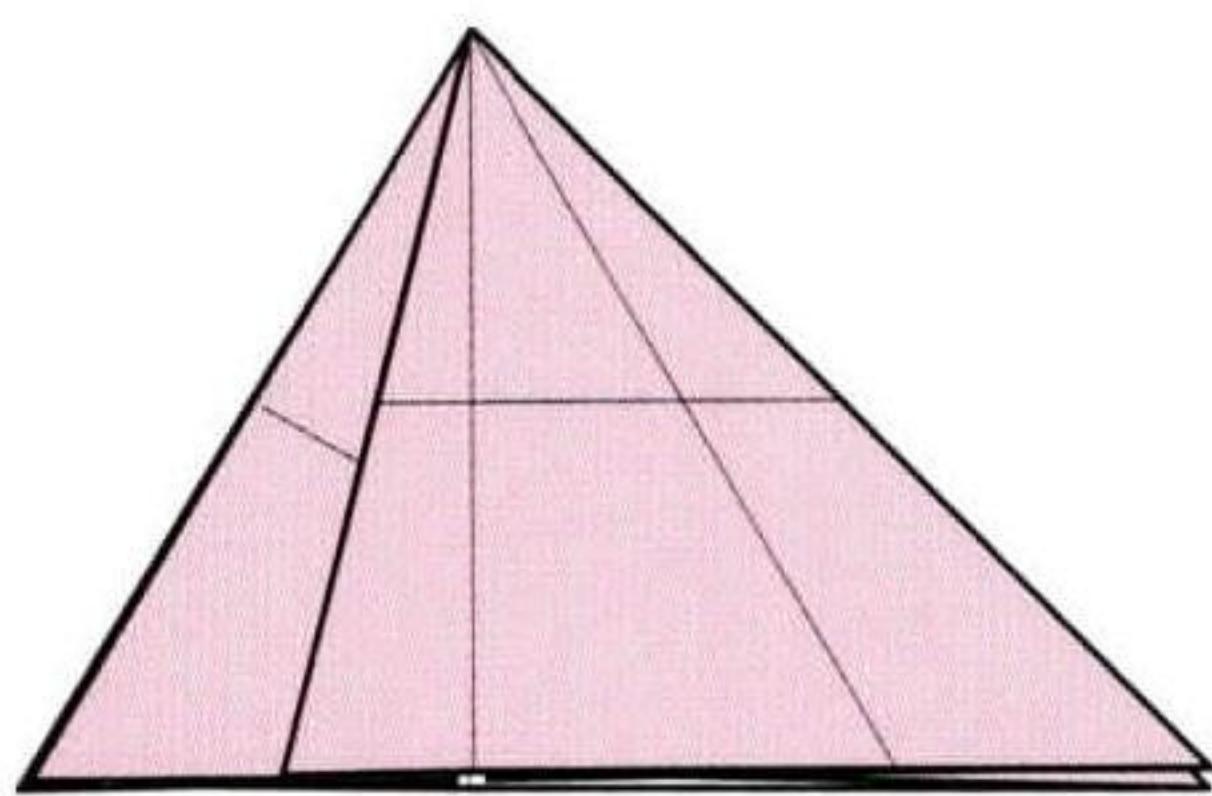

16 Turn the model over left to right.

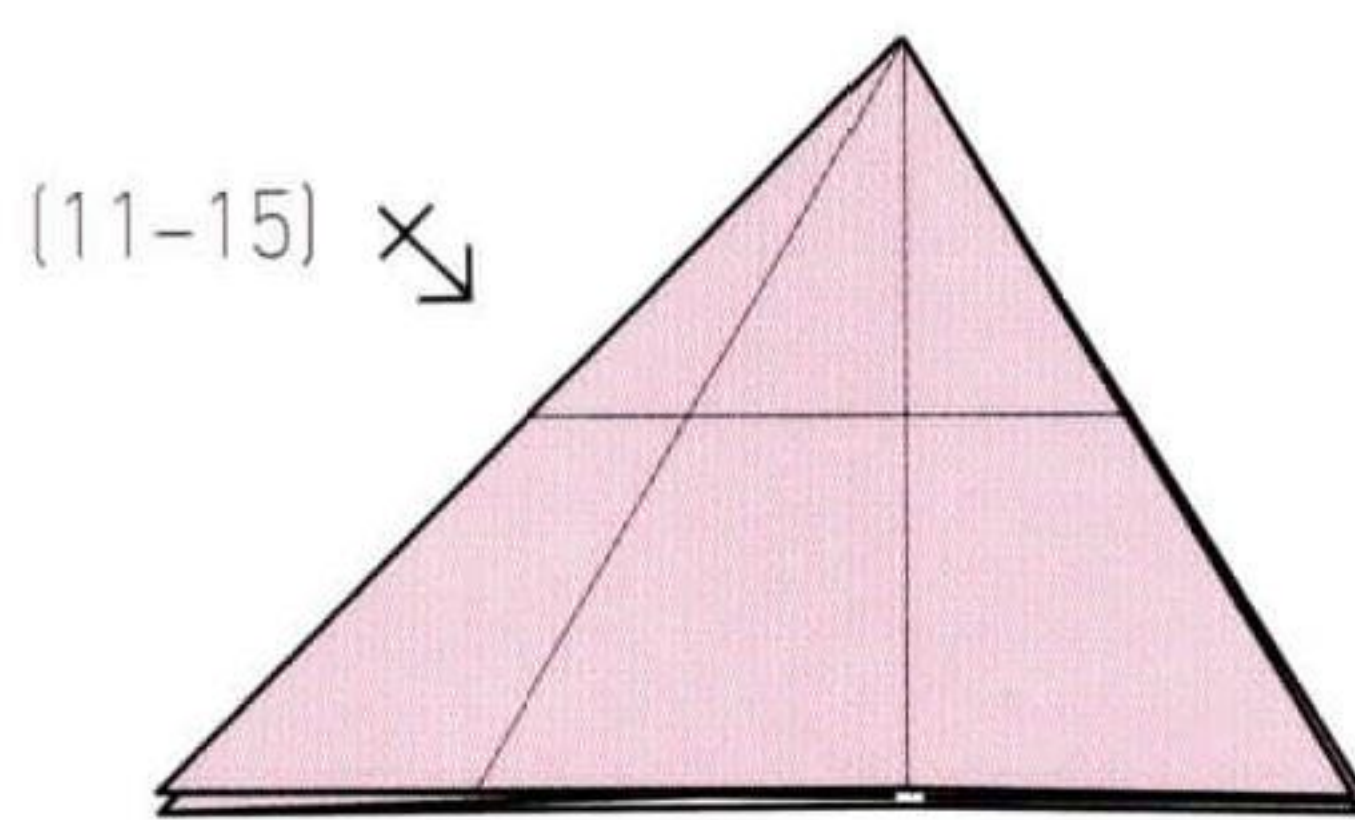

17 Repeat steps 11 to 15.

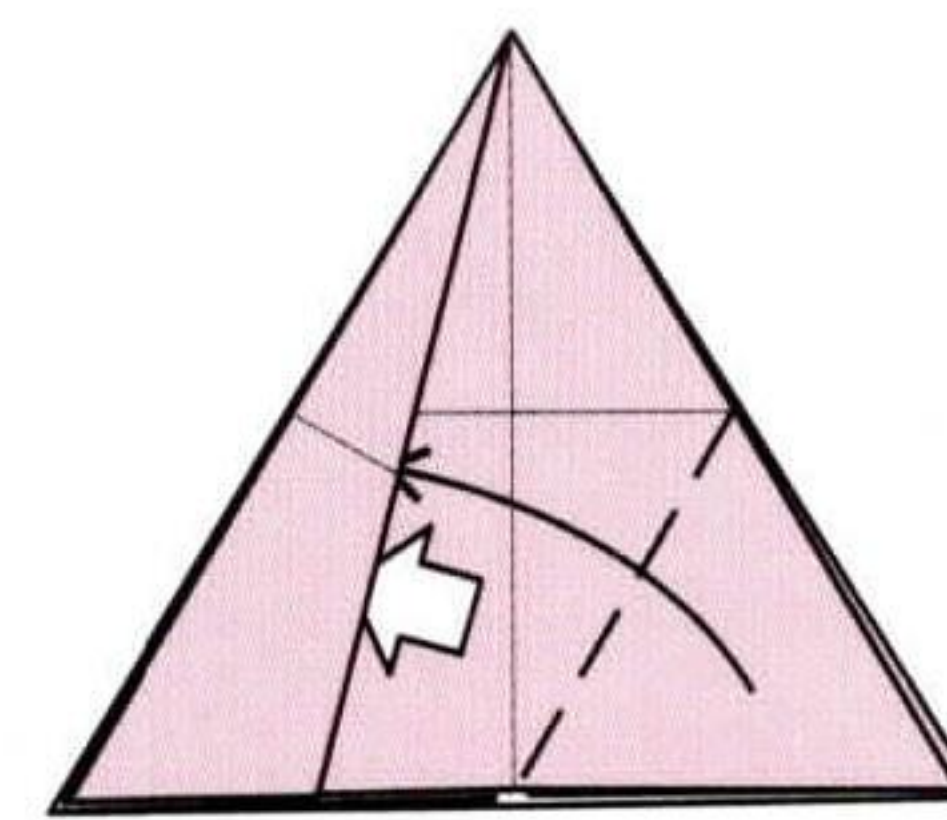

18 Fold the corner in and tuck it underneath the folded edge on the opposite side of the model.

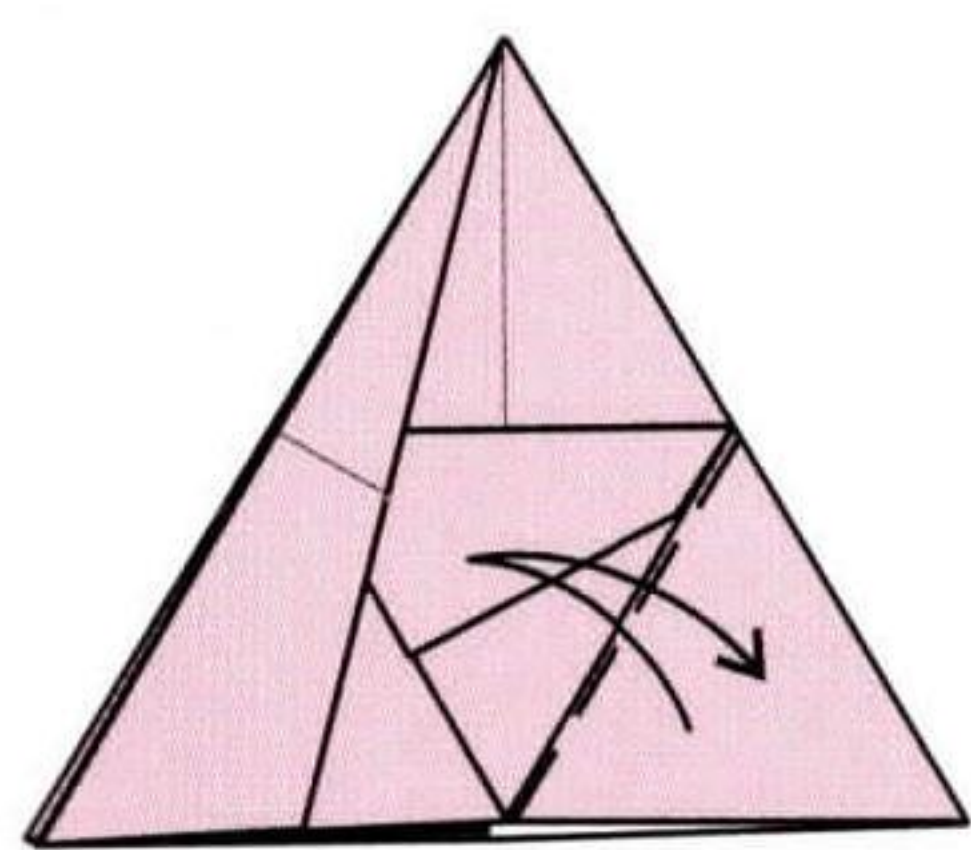

19 Fold and unfold the corner along the adjacent folded edge.

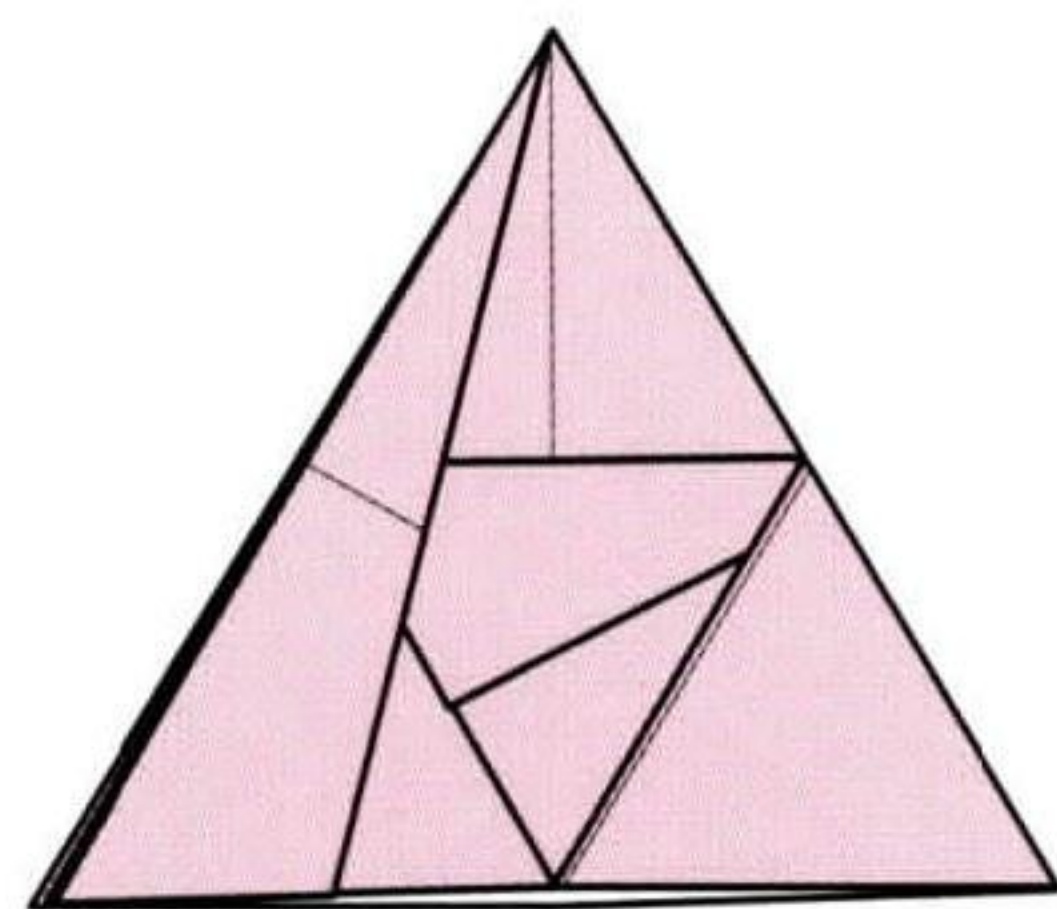

20 Turn the model over left to right.

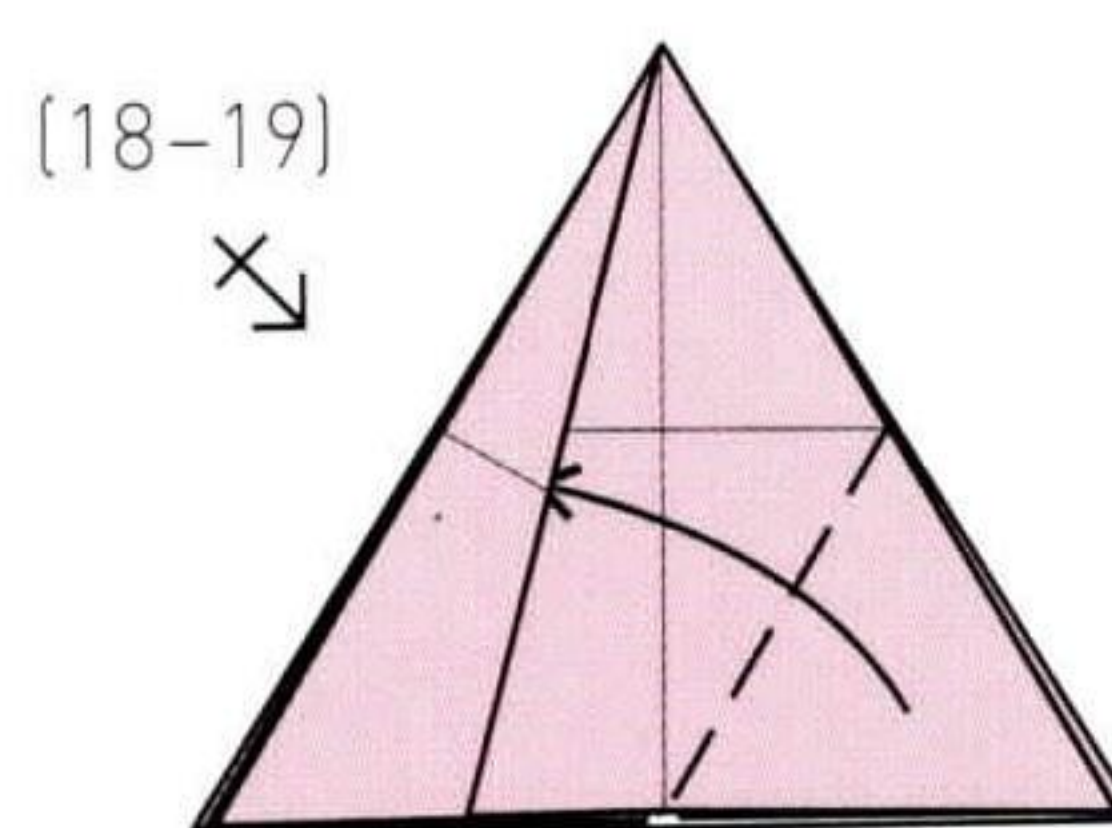

21 Fold the corner in and repeat steps 18 to 19.

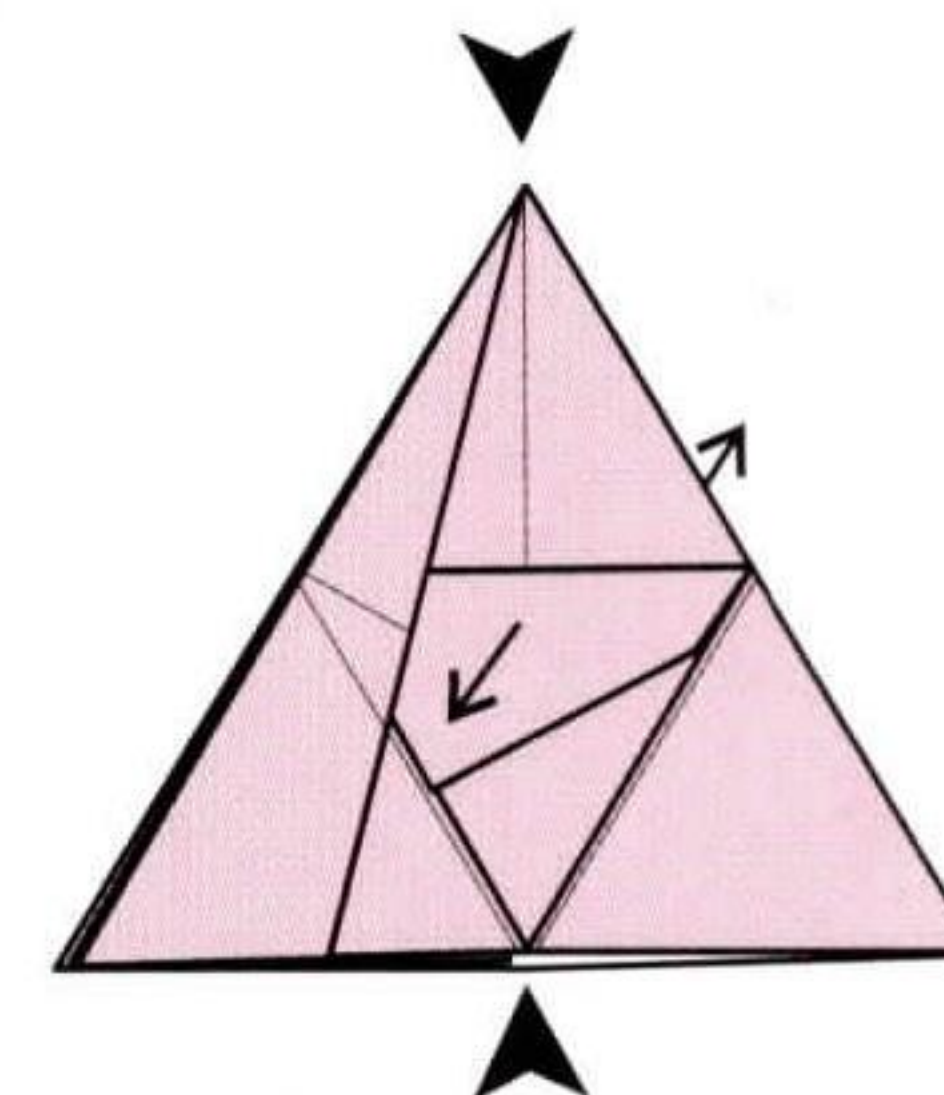

22 Open out the model and pinch the two remaining corners together.

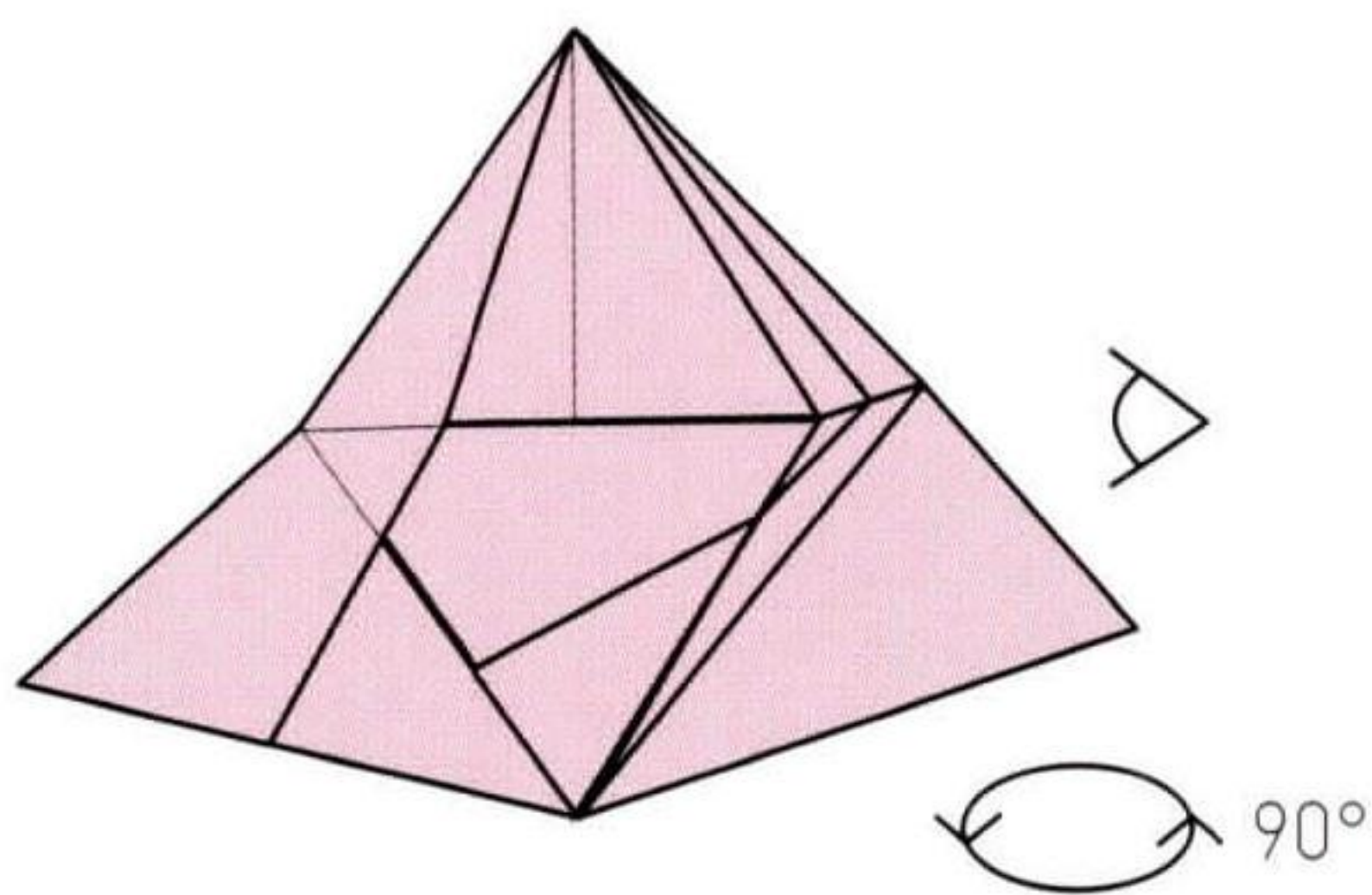

23 Rotate the model to look at the other sides.

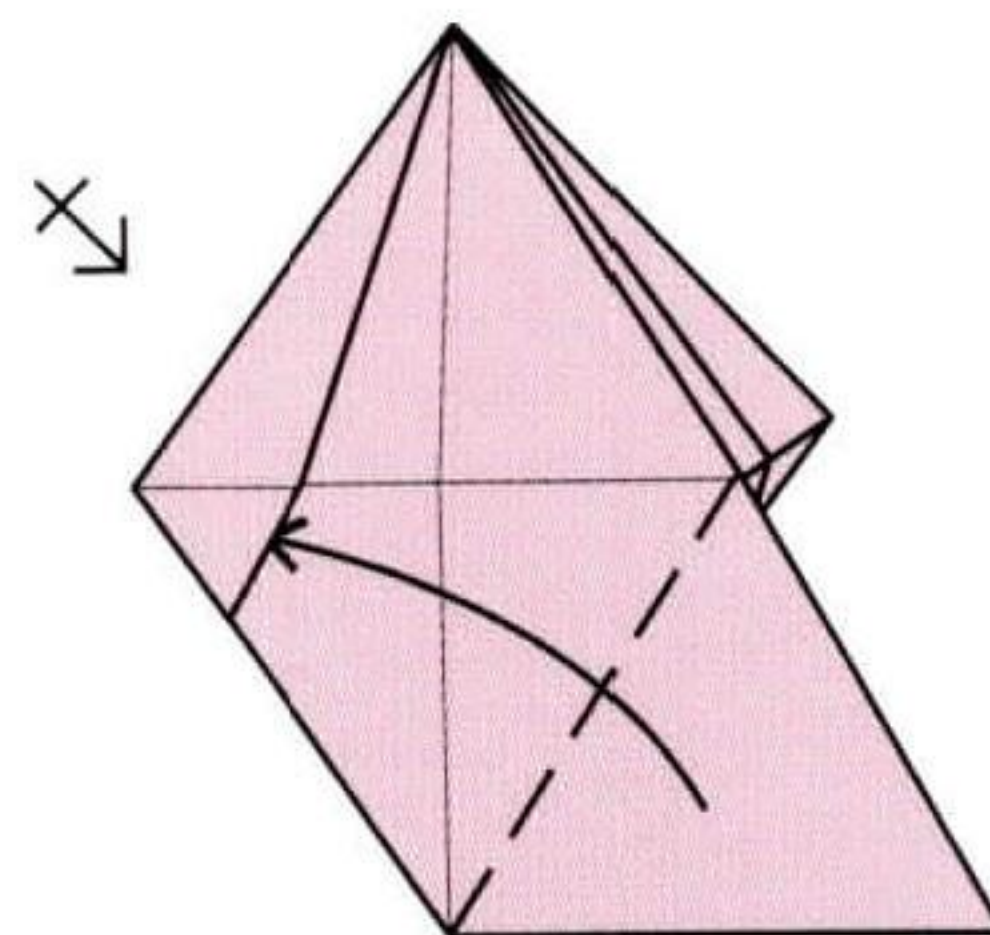

24 Fold the corners of the front and rear sections into the pockets opposite.

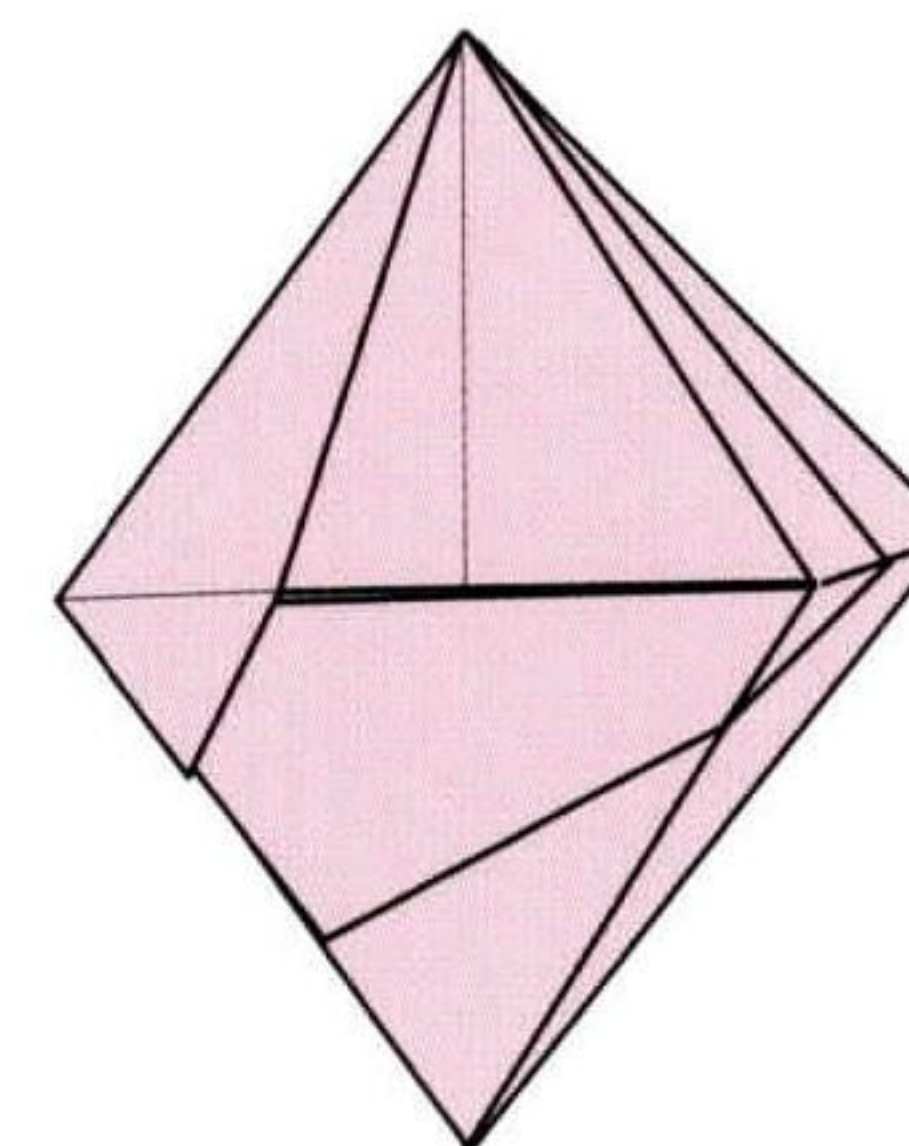

25 Complete.

Octahedron Two

**

This octahedron is formed by dividing the starting square into thirds and using the geometry formed by the creases. The inverted point adds rigidity to the model.

18 X 18CM (7 X 7IN)

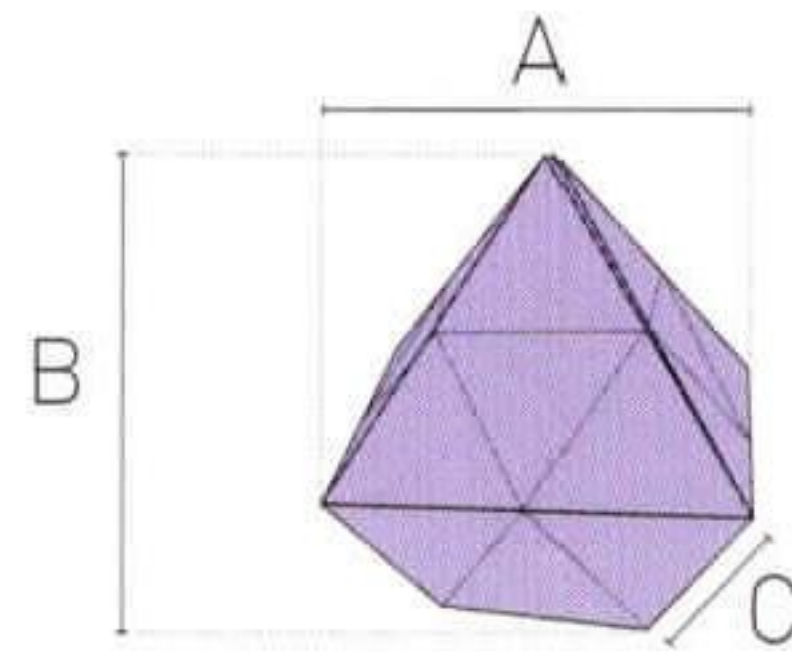
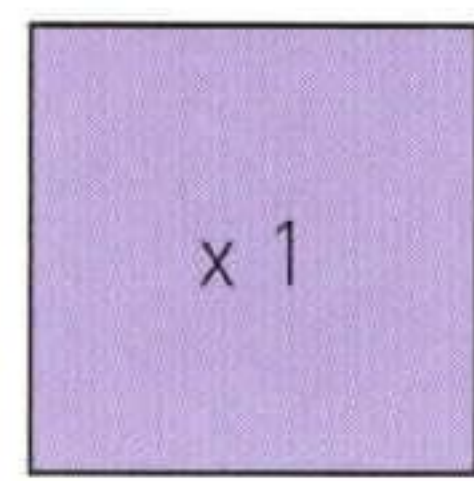

A	5.3cm	(2in)
B	5.8cm	(2¼in)
C	5.3cm	(2in)

START WITH A SQUARE, COLOURED SIDE UP.

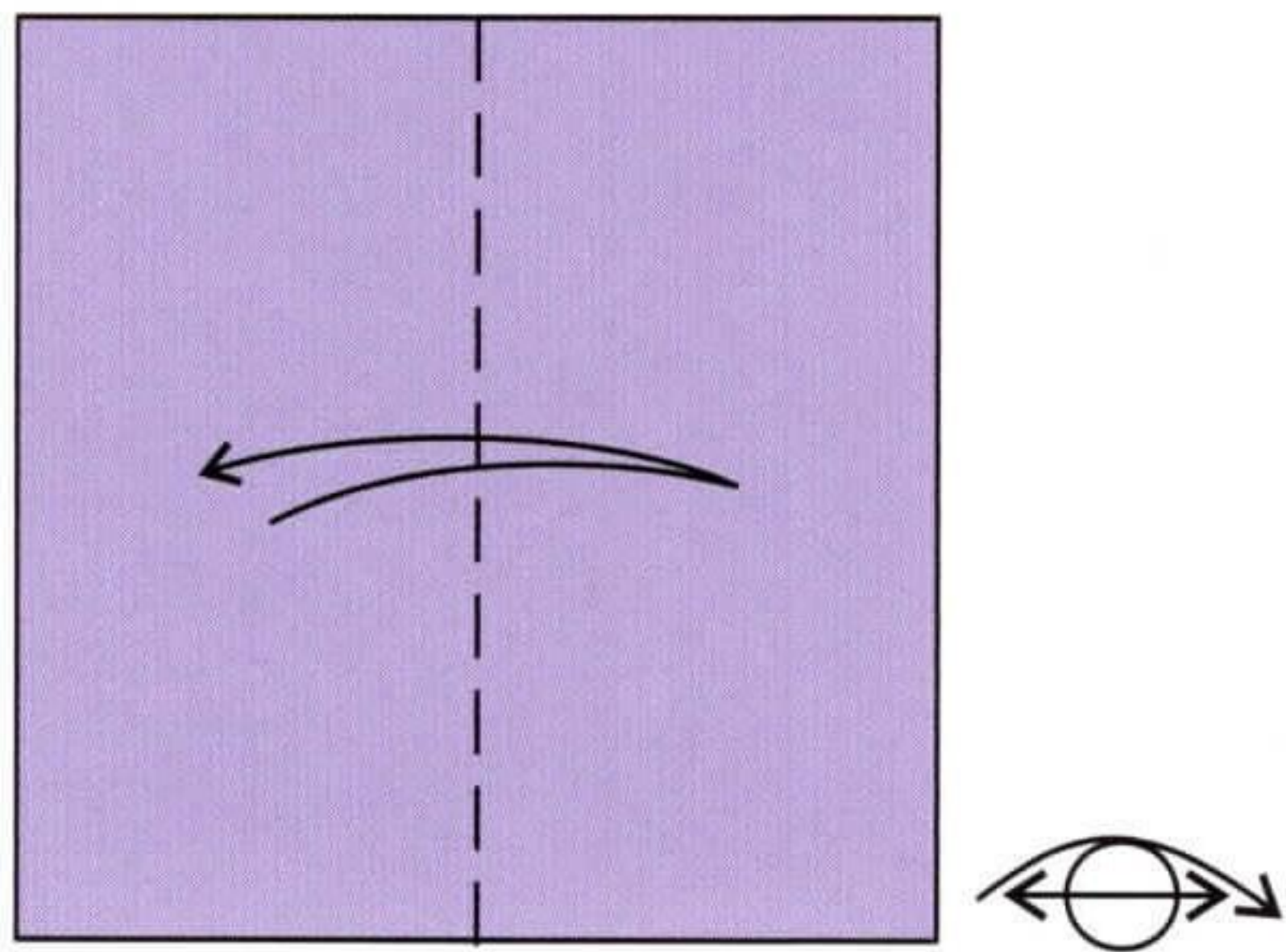

- 1 Fold and unfold the square in half lengthwise. Then turn the model over left to right.

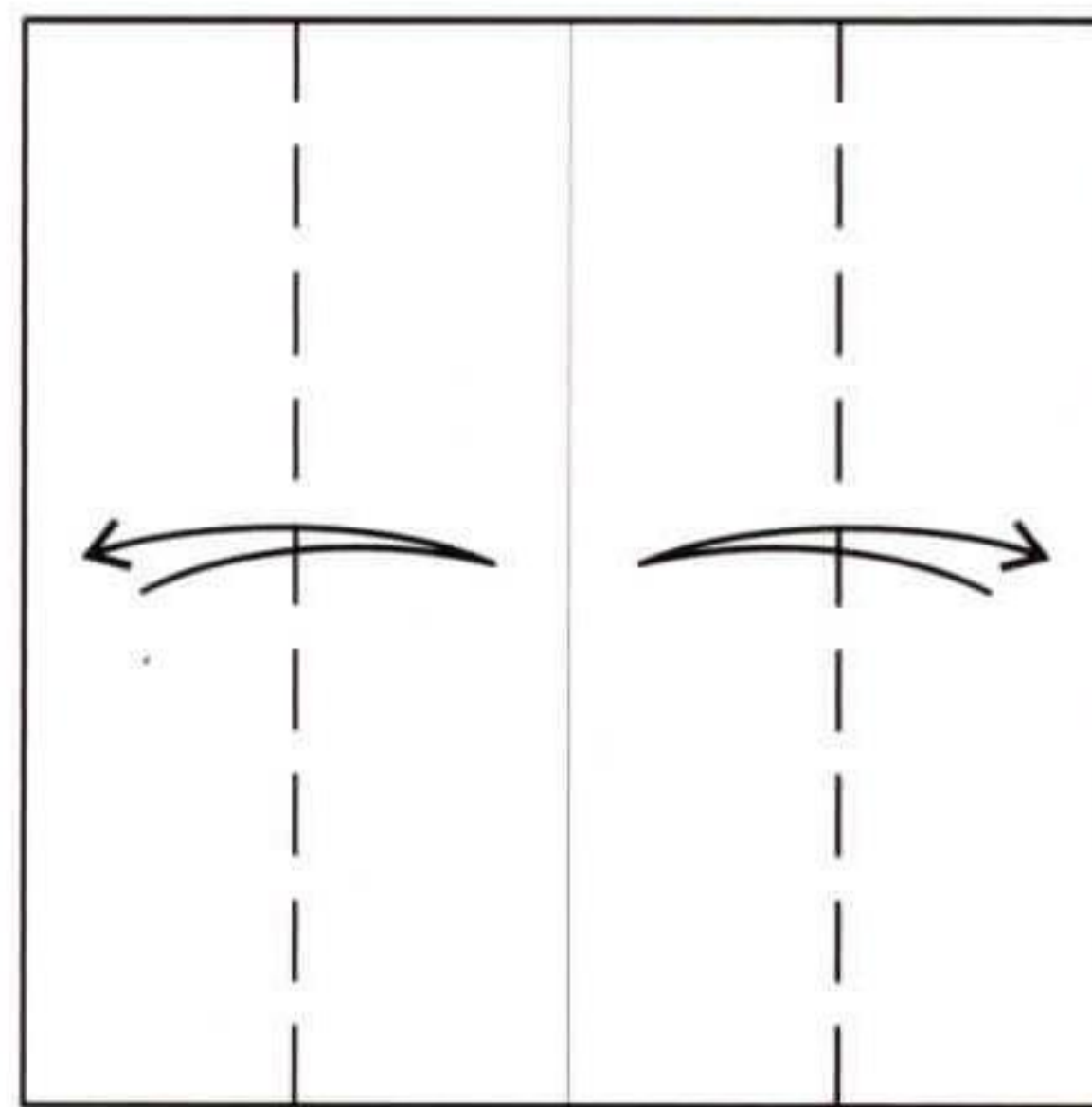

- 2 Fold the outer sides in to the middle crease and unfold.

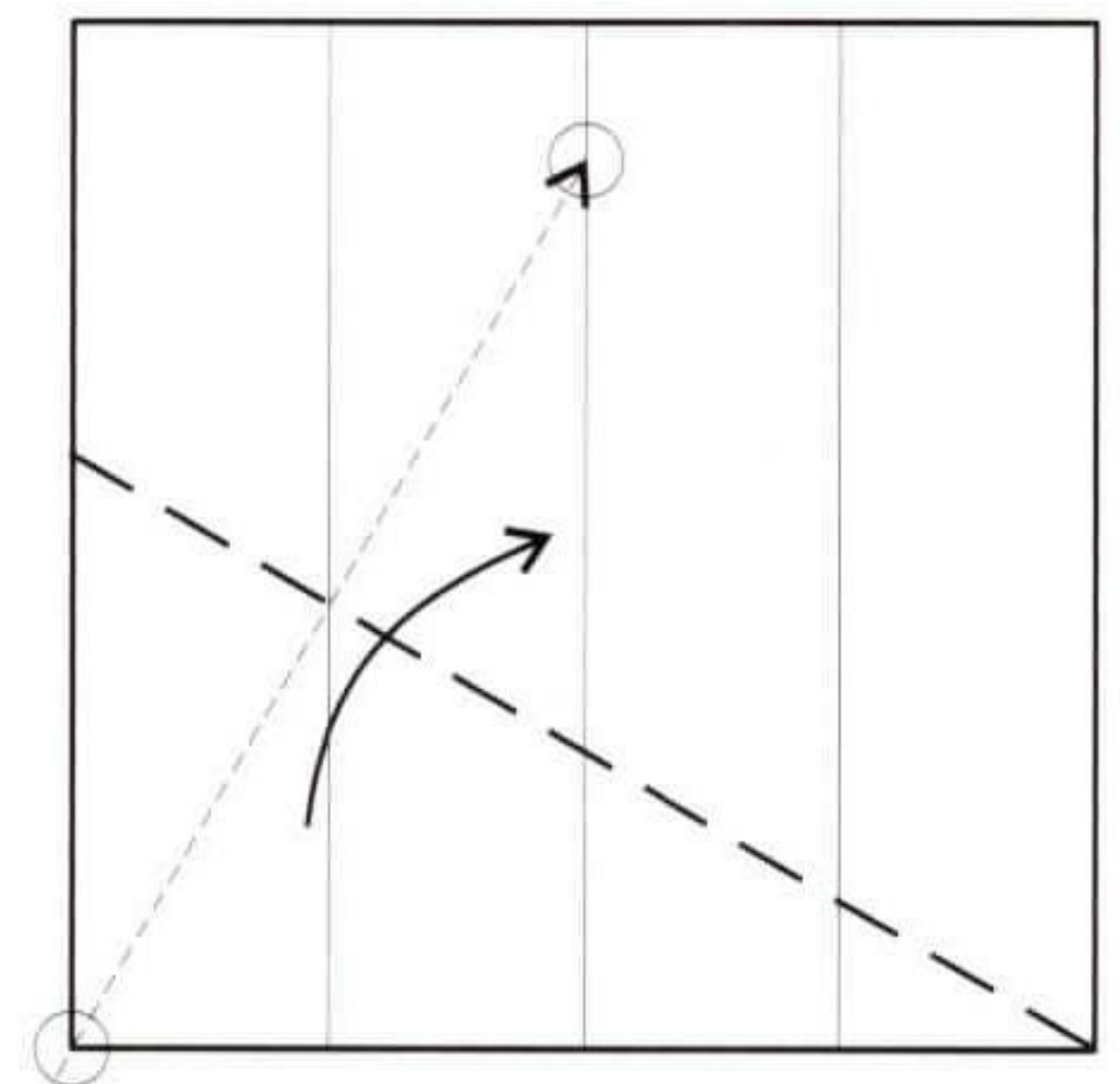

- 3 Fold the lower section up diagonally from the lower right corner. The left corner will touch the middle crease.

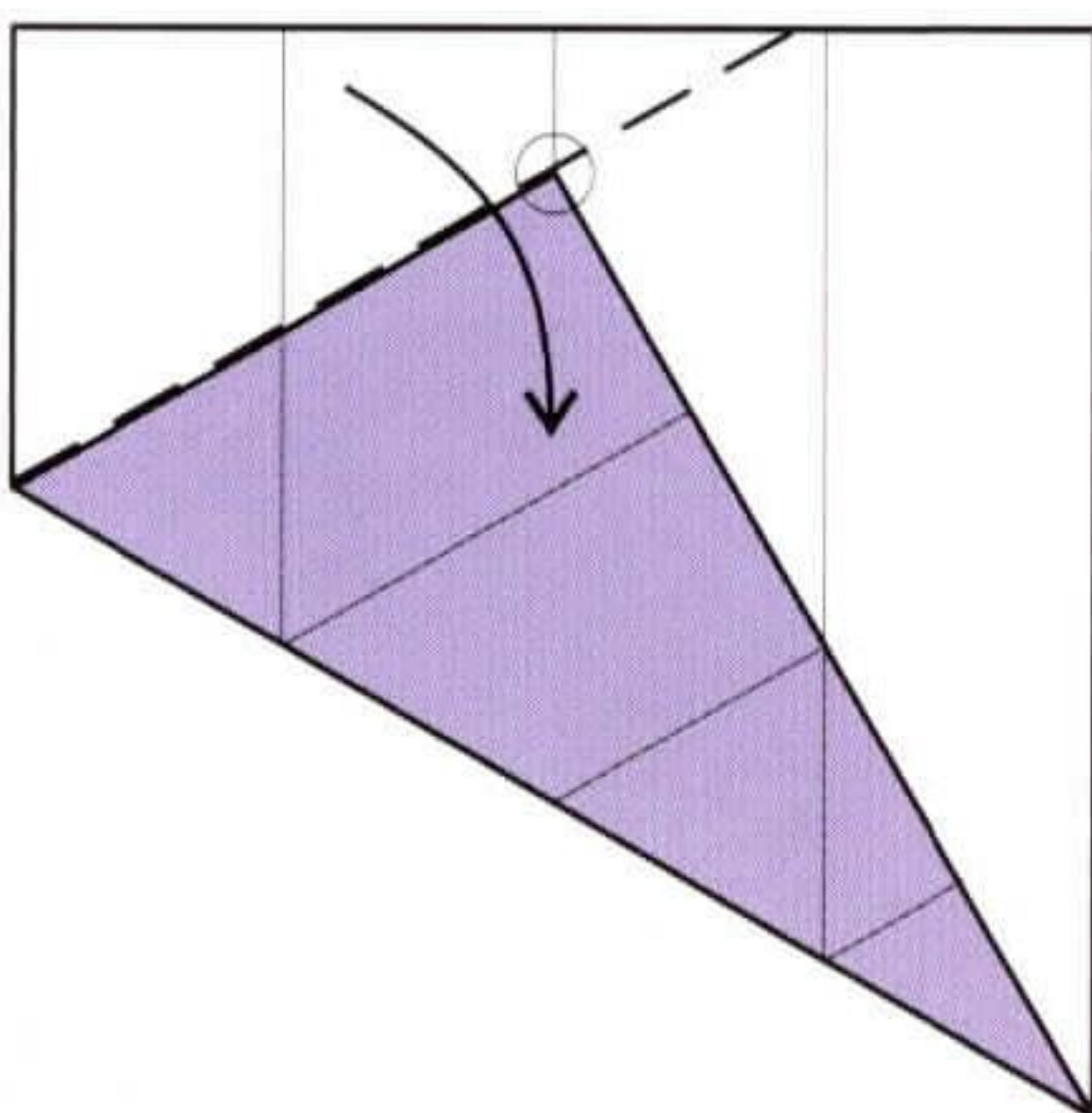

- 4 Fold the upper corner down over the folded edge.

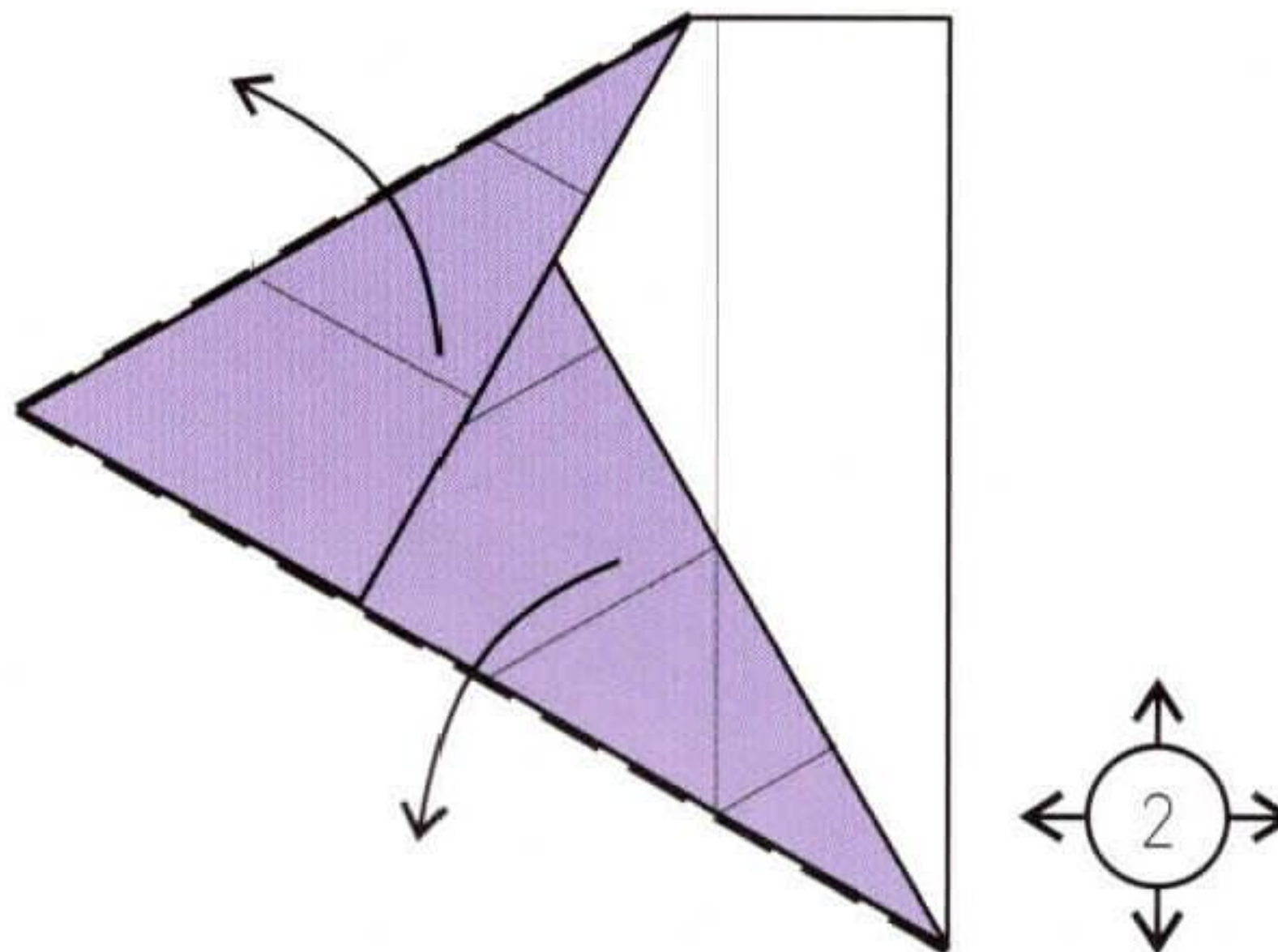

- 5 Unfold back to a square (step 2).

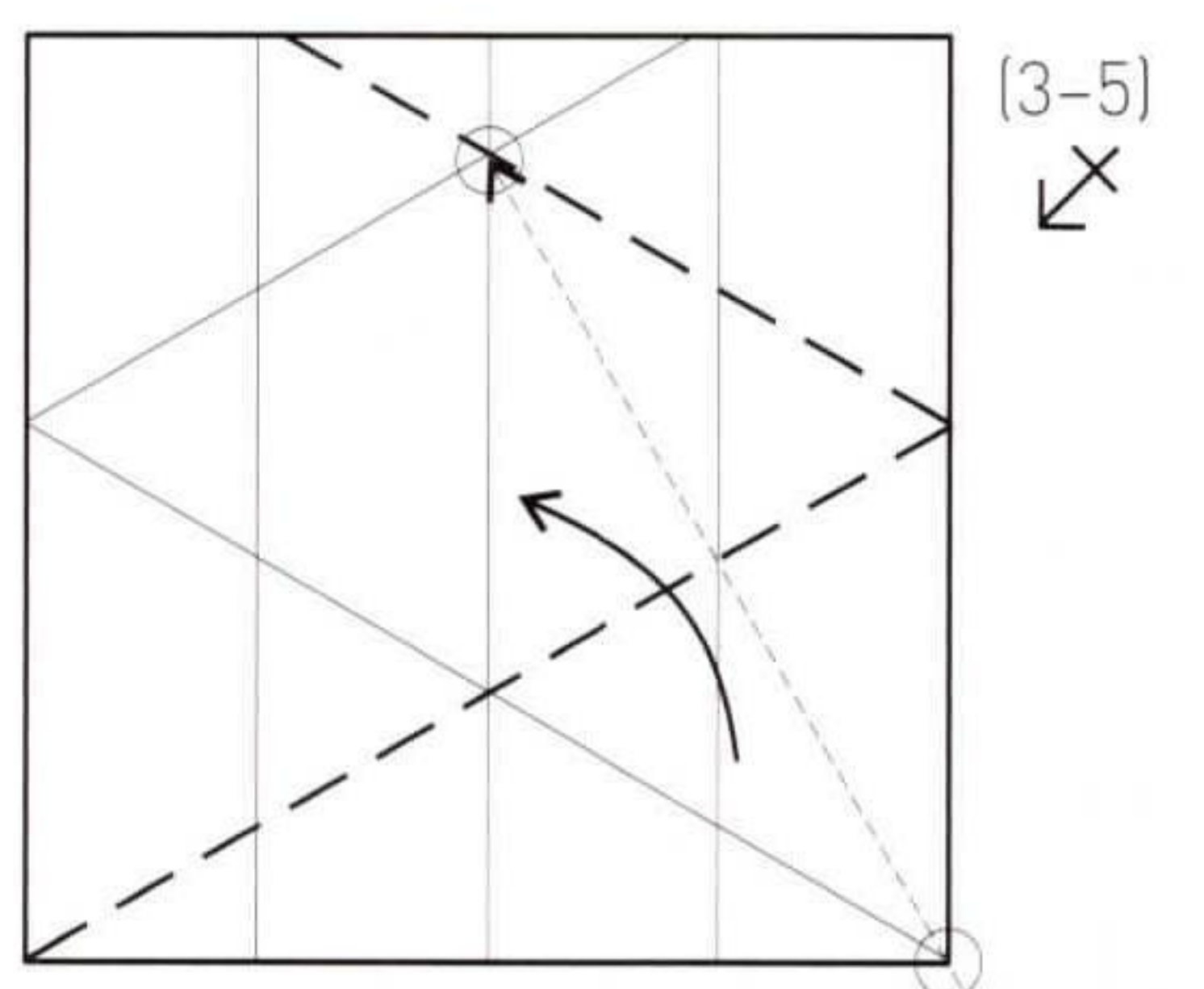

- 6 Repeat steps 3 to 5 on the other side.

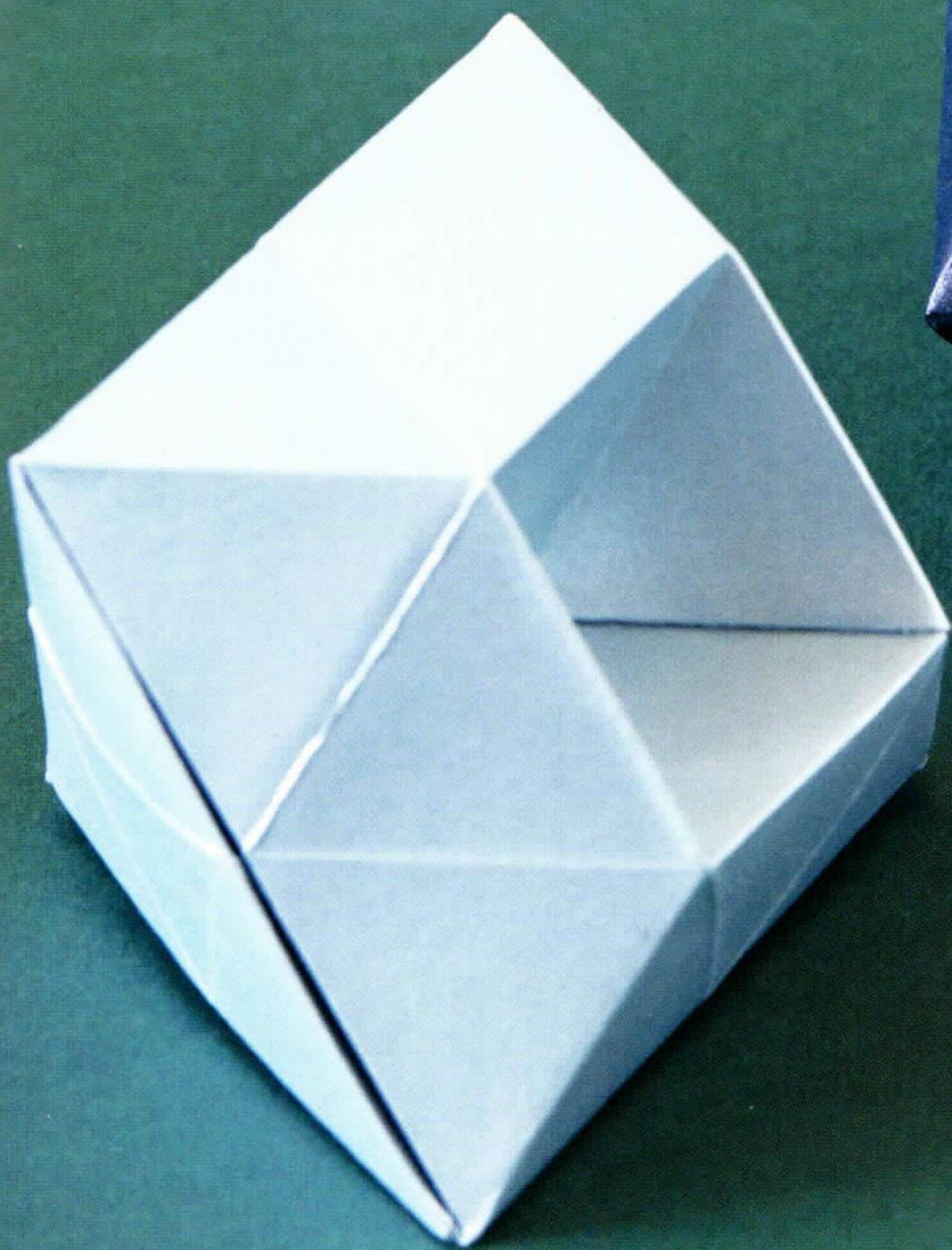
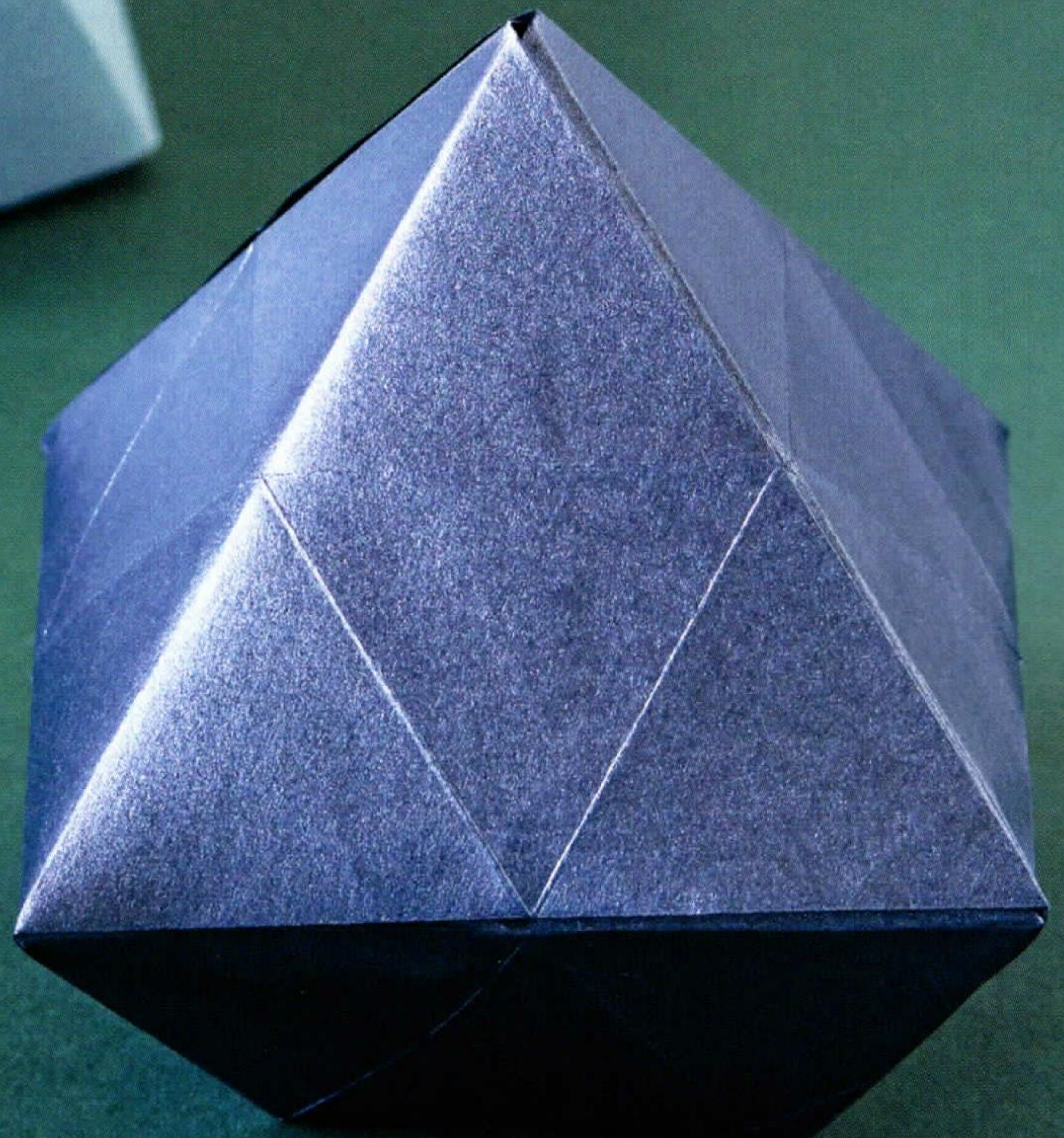
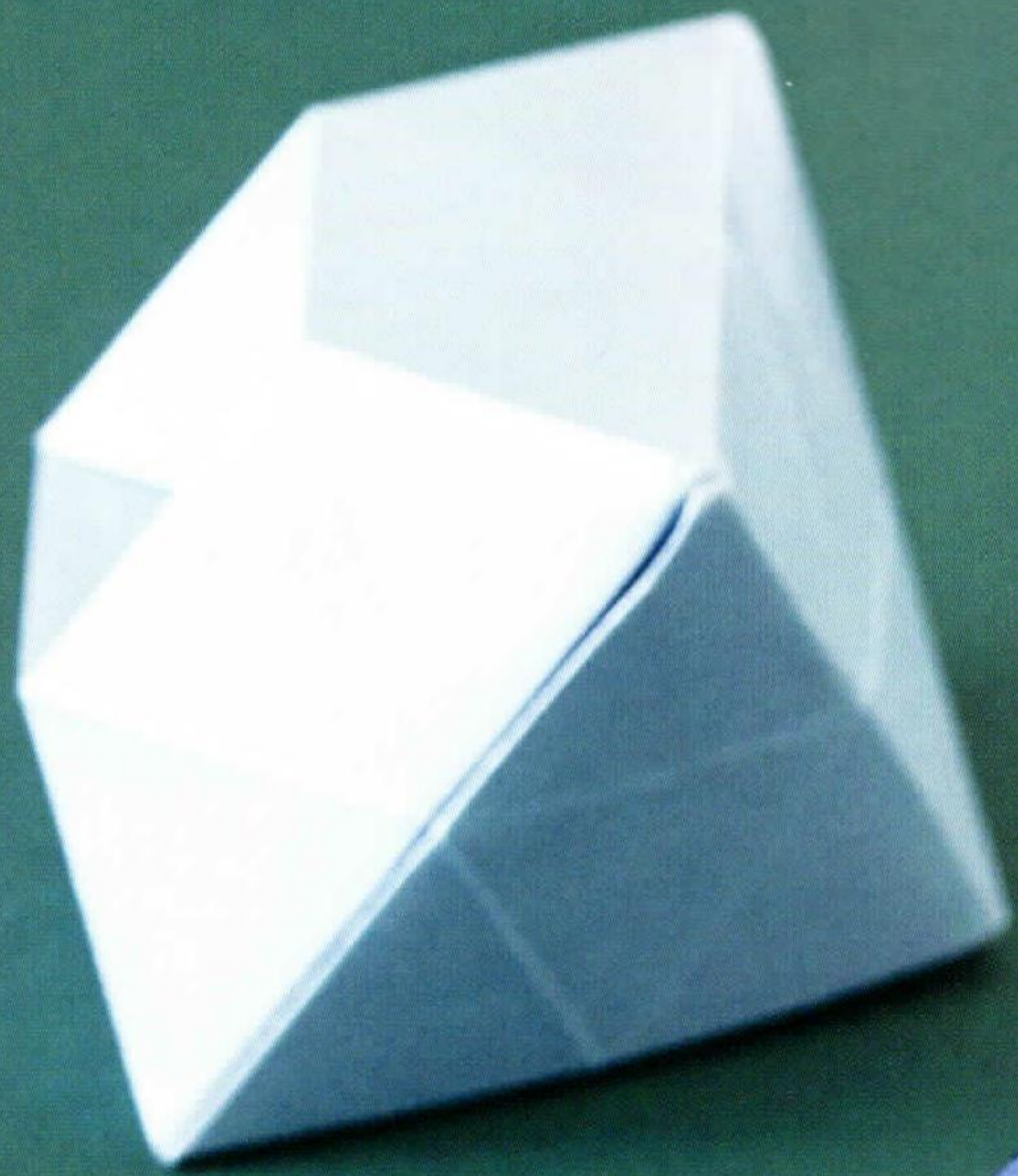

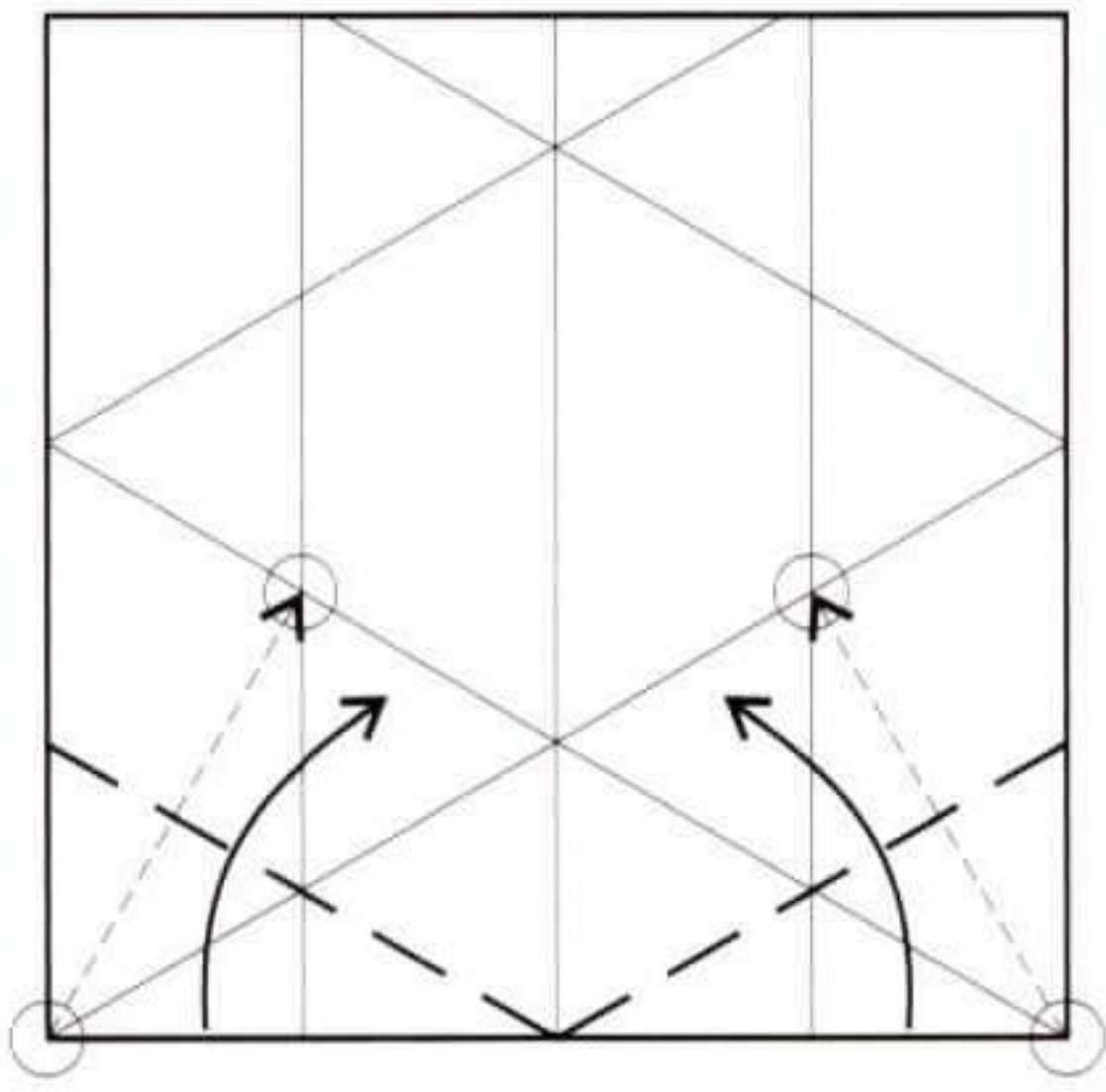

7 Fold the lower corners up to touch the adjacent creases.

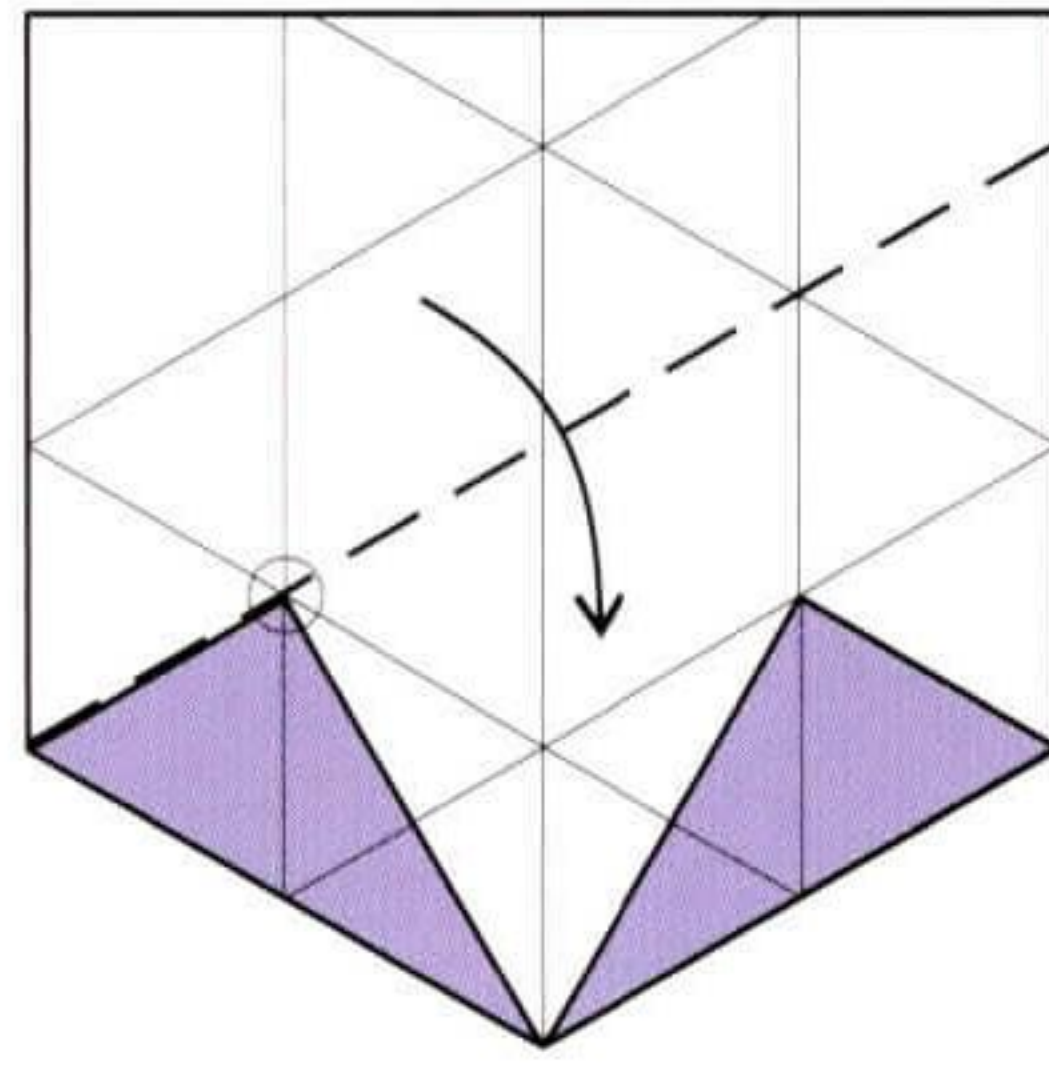

8 Fold the upper section over along the adjacent folded edge.

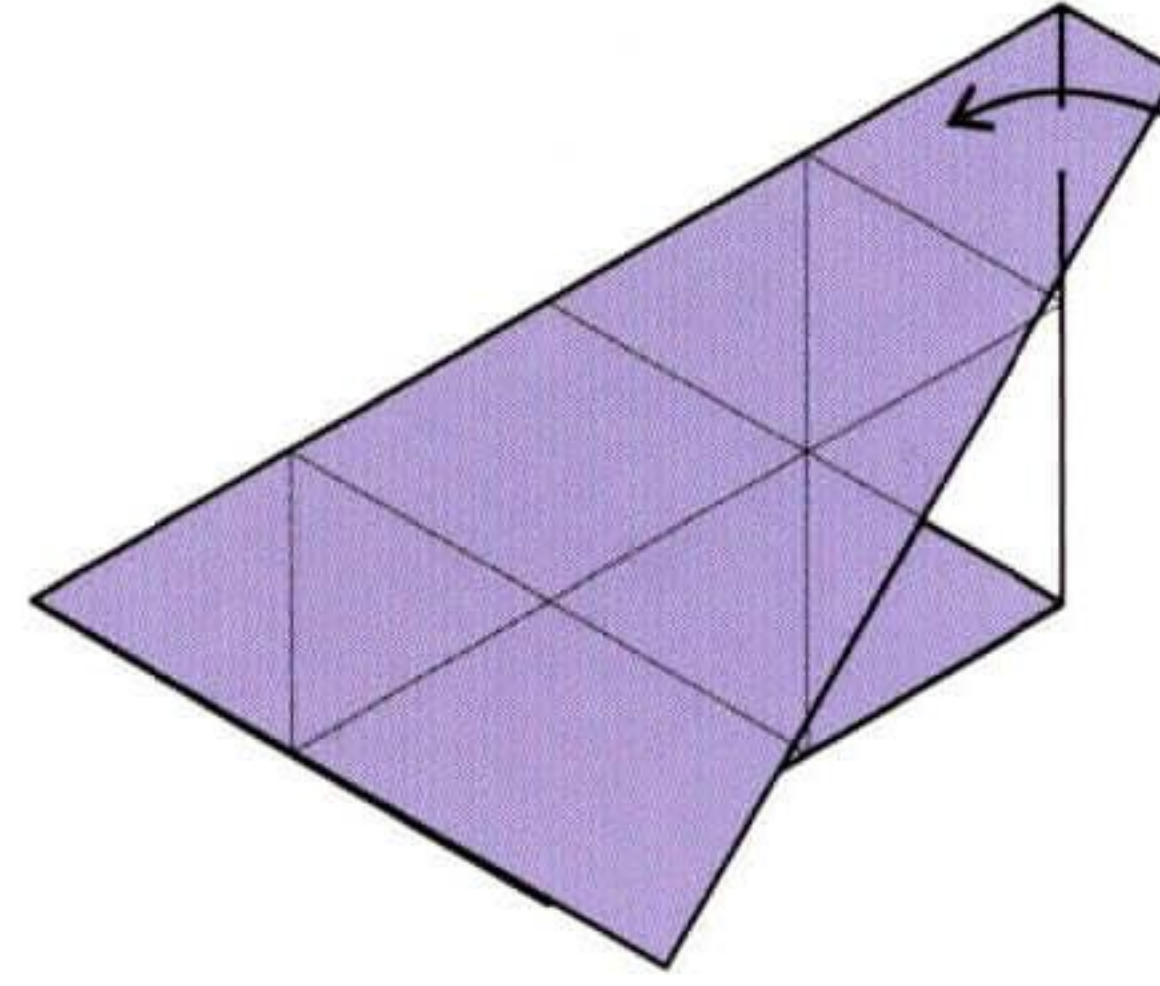

9 Fold the corner over.

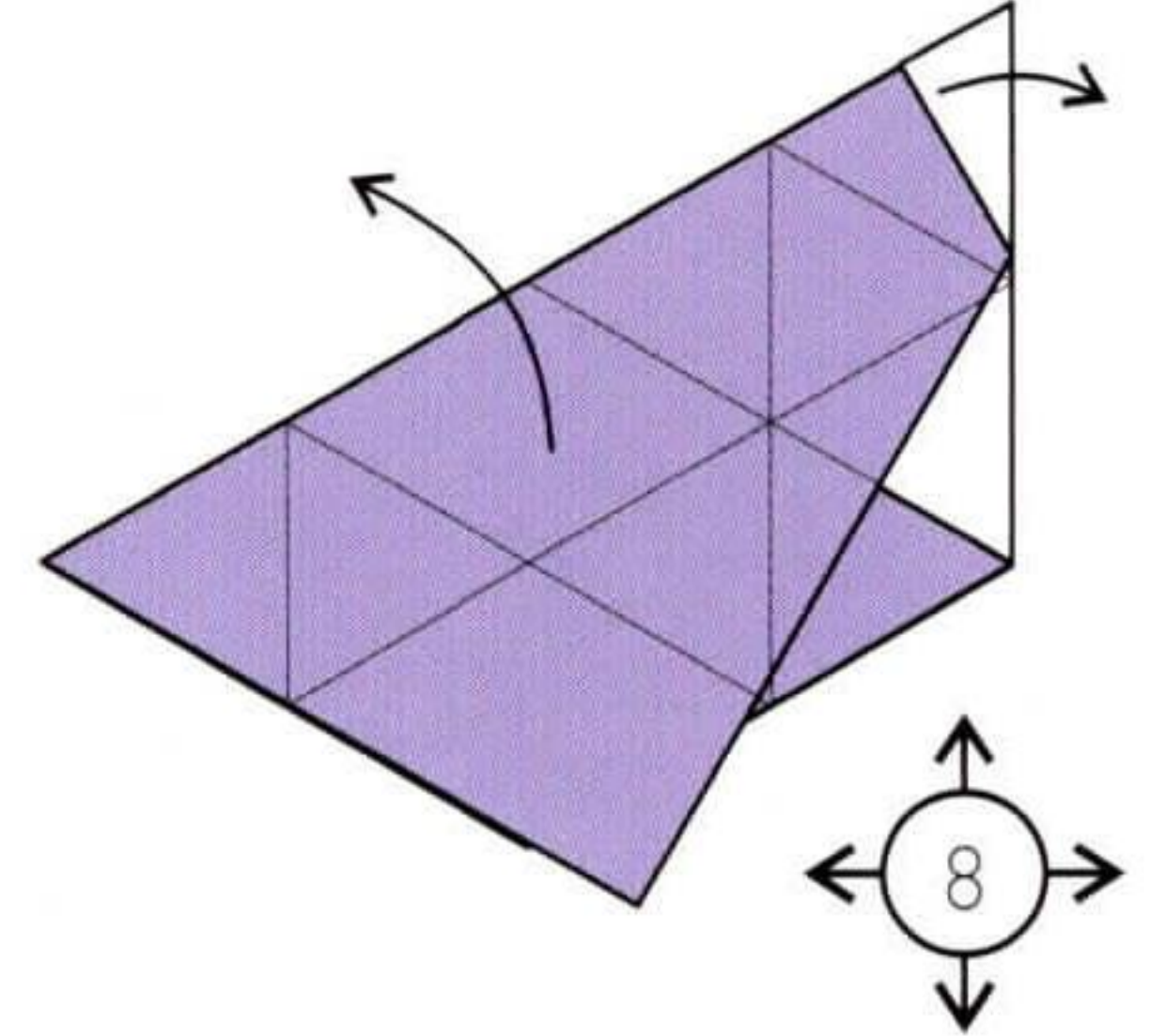

10 Unfold the last two steps (to step 8).

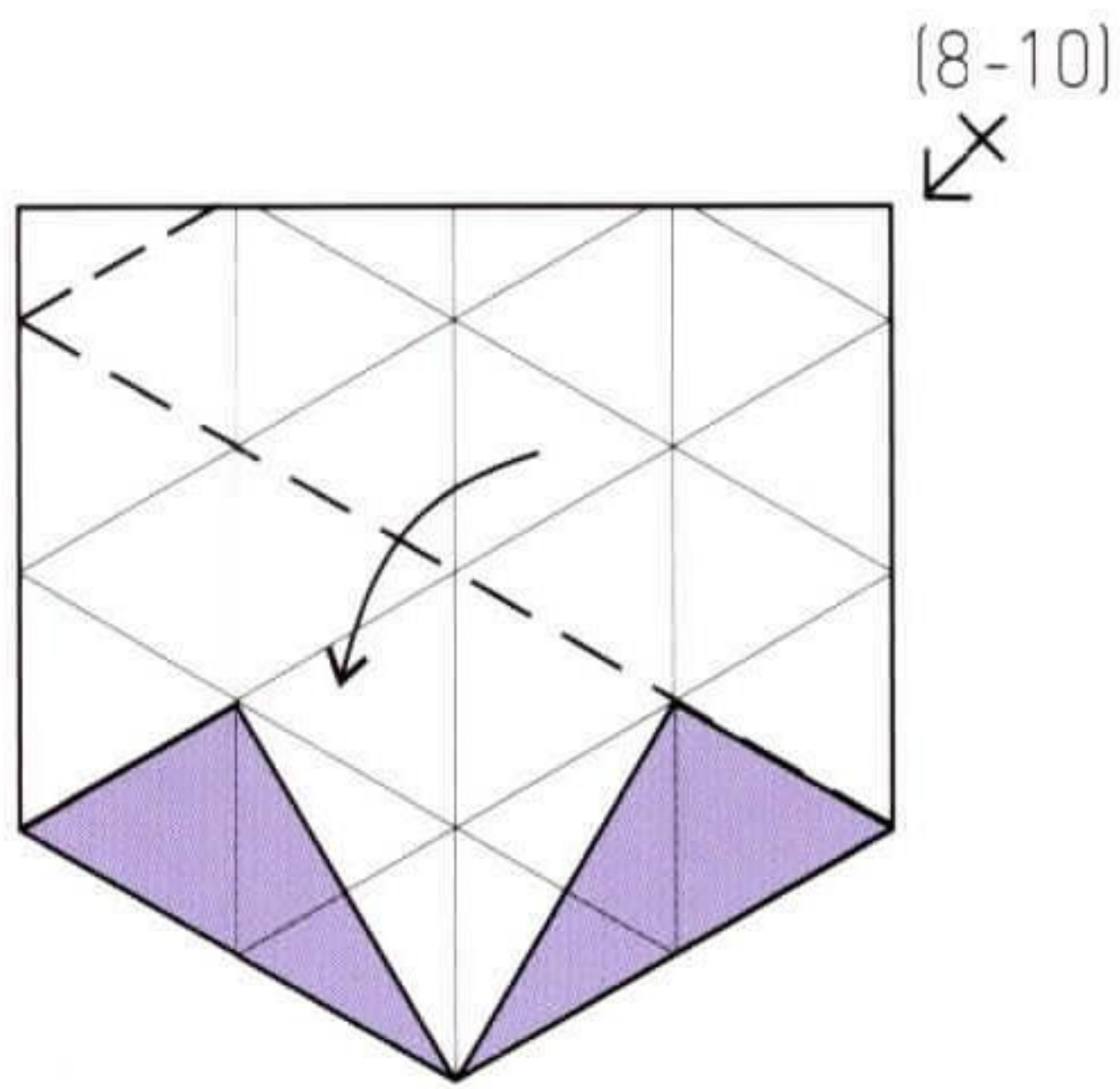

11 Repeat steps 8 to 10 on the other side.

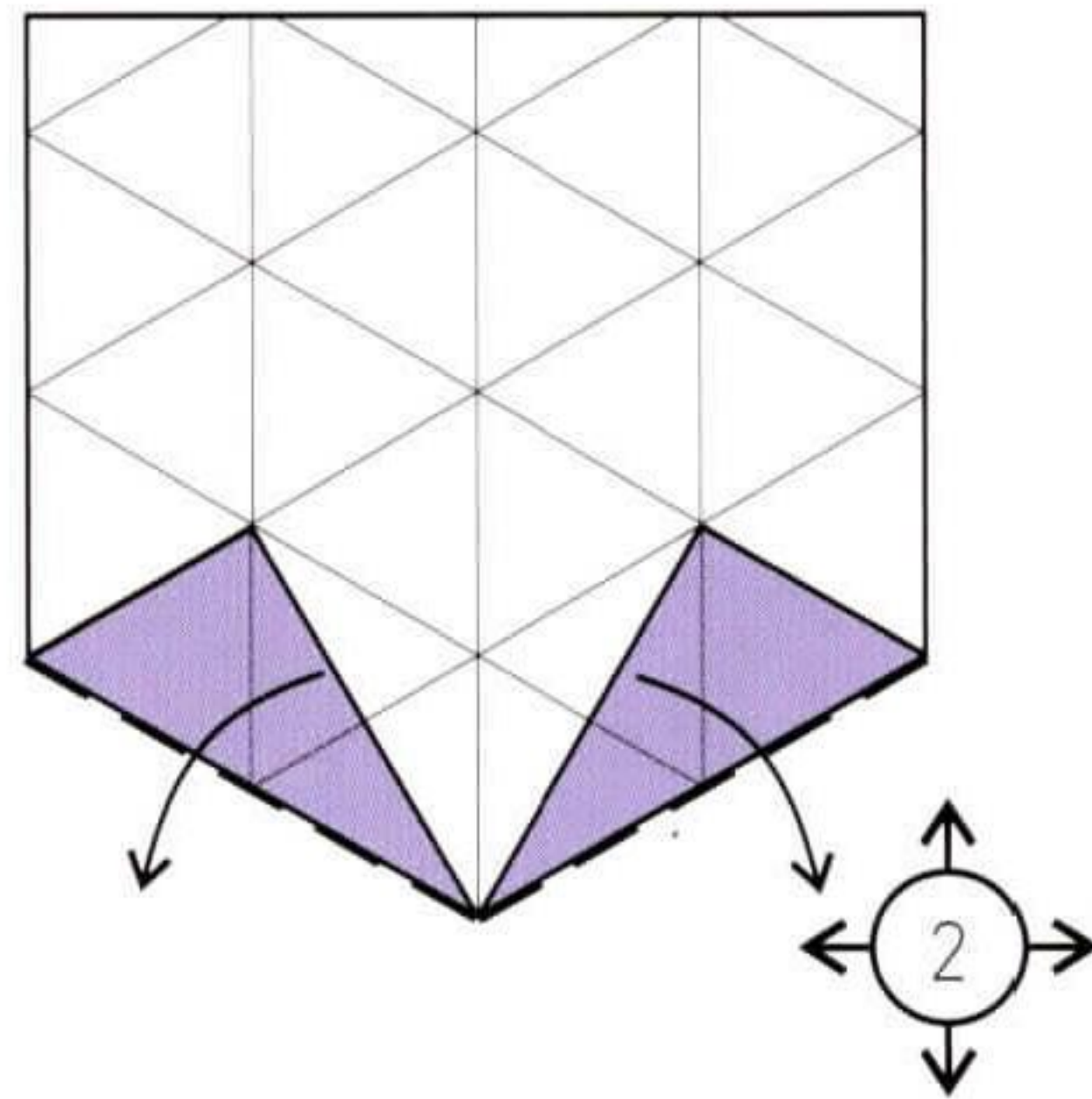

12 Unfold the lower corners. (Back to a square, step 2).

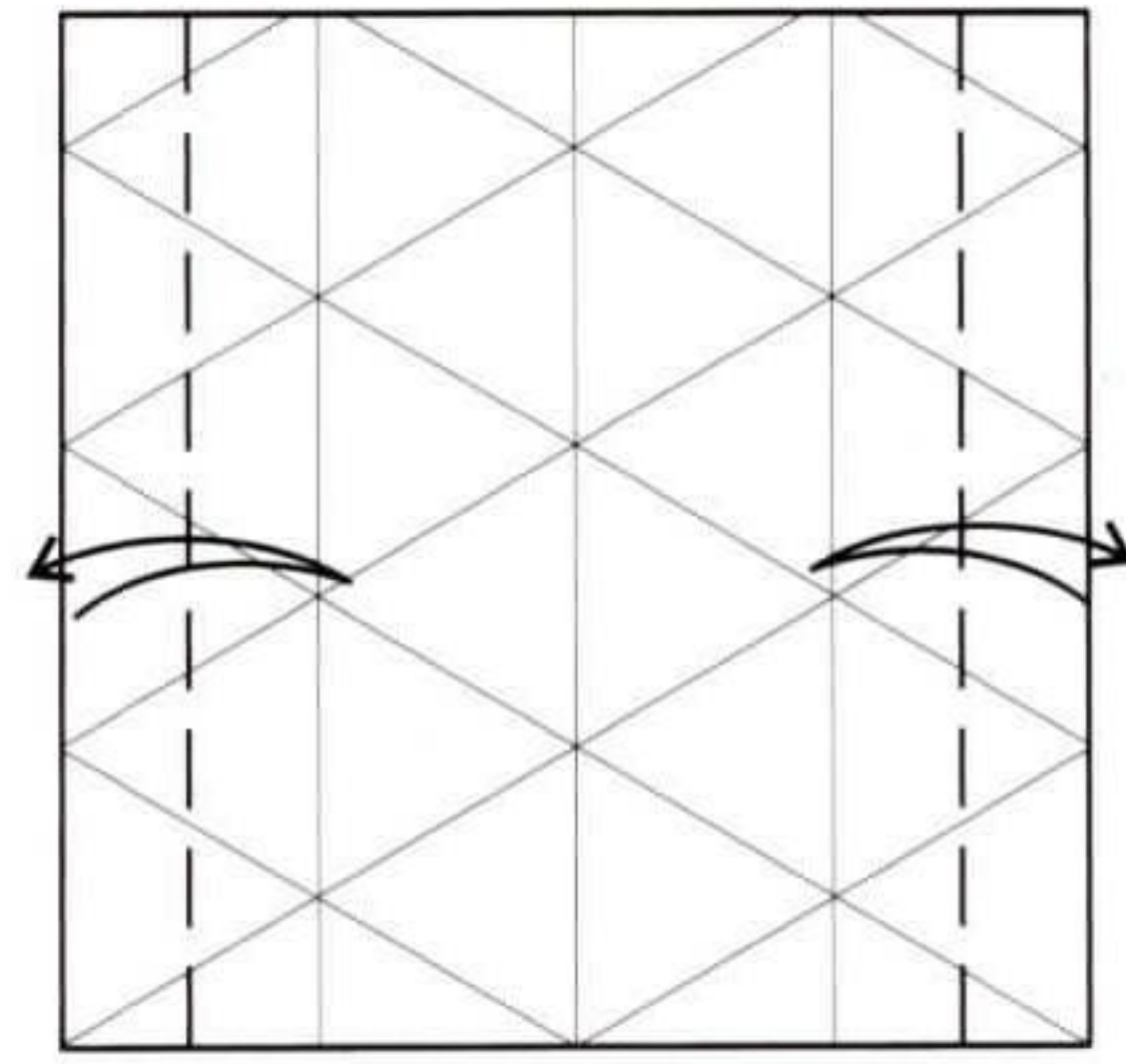

13 Fold the outer edges in to the adjacent creases. Then unfold.

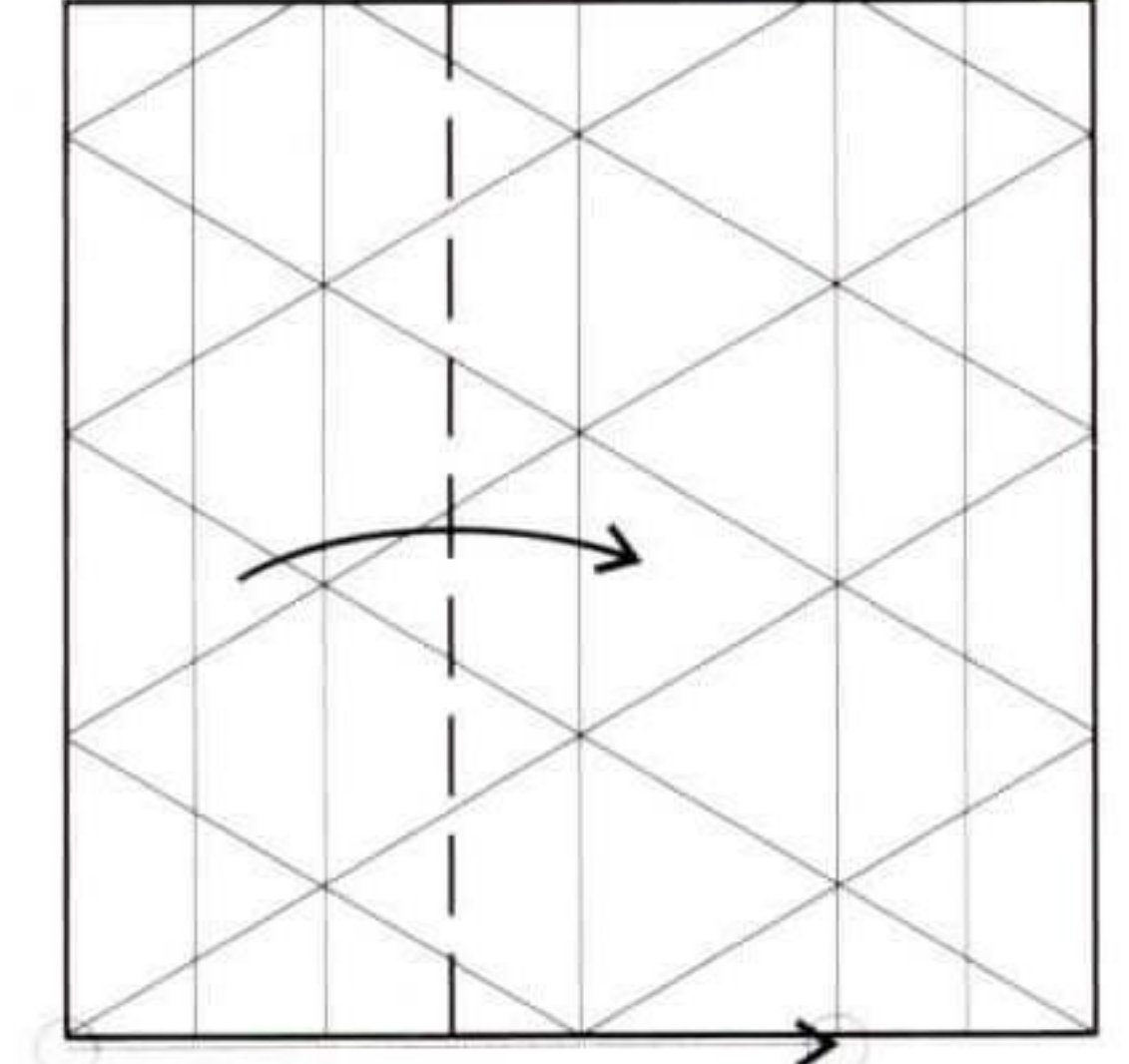

14 Fold the left outer edge over between the two creases.

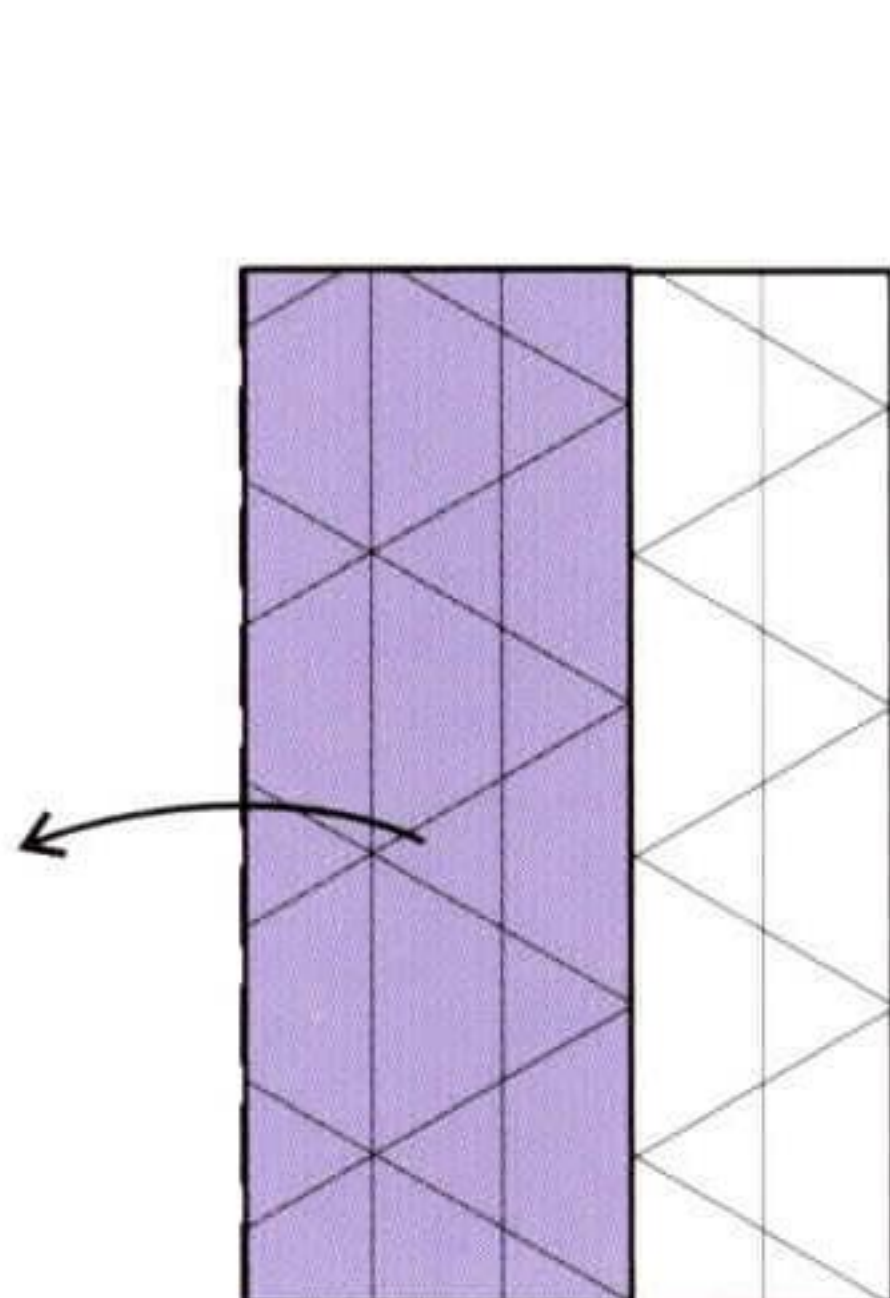

15 Fold it back.

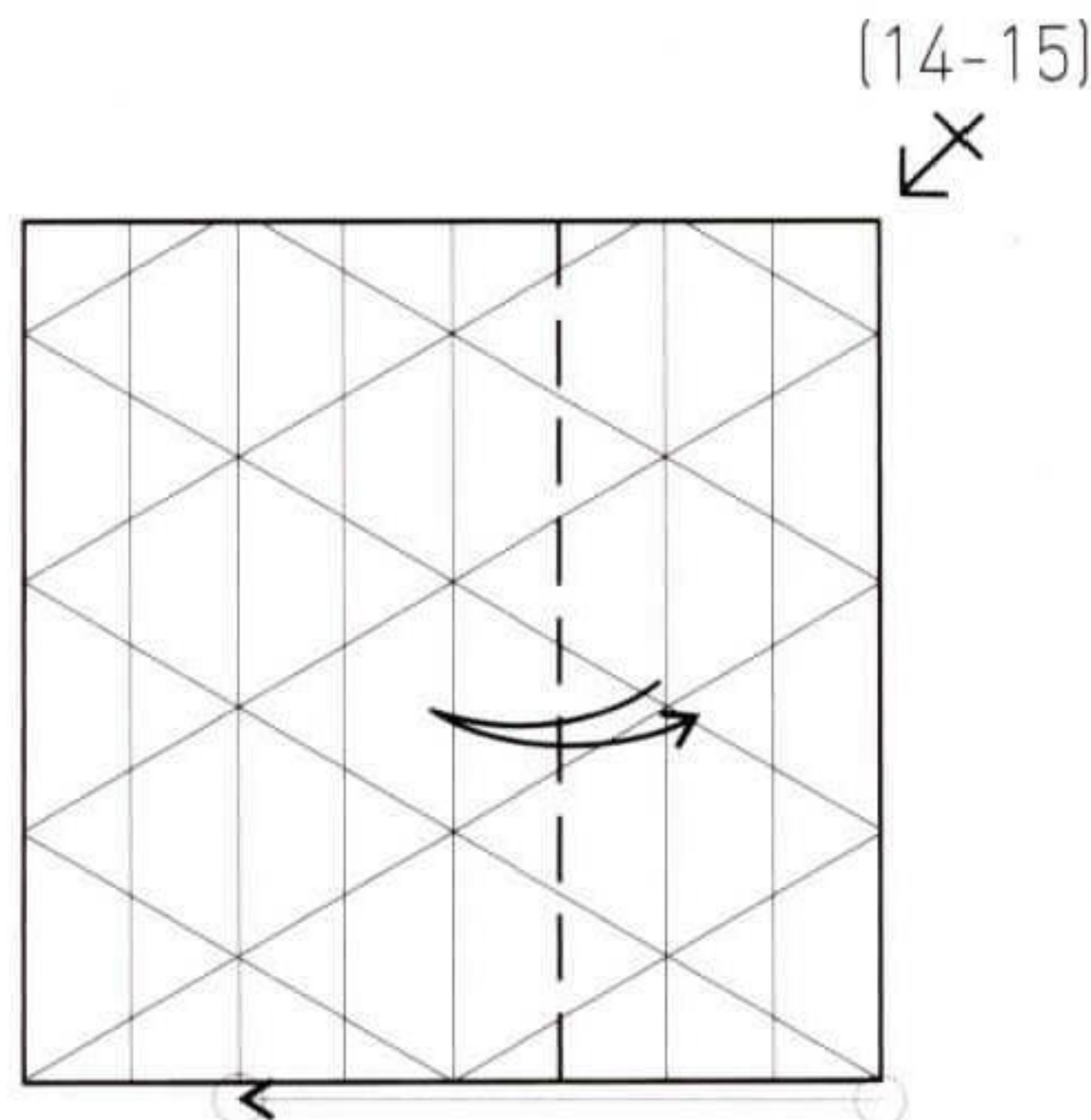

16 Fold and unfold the right outer edge between the two creases.

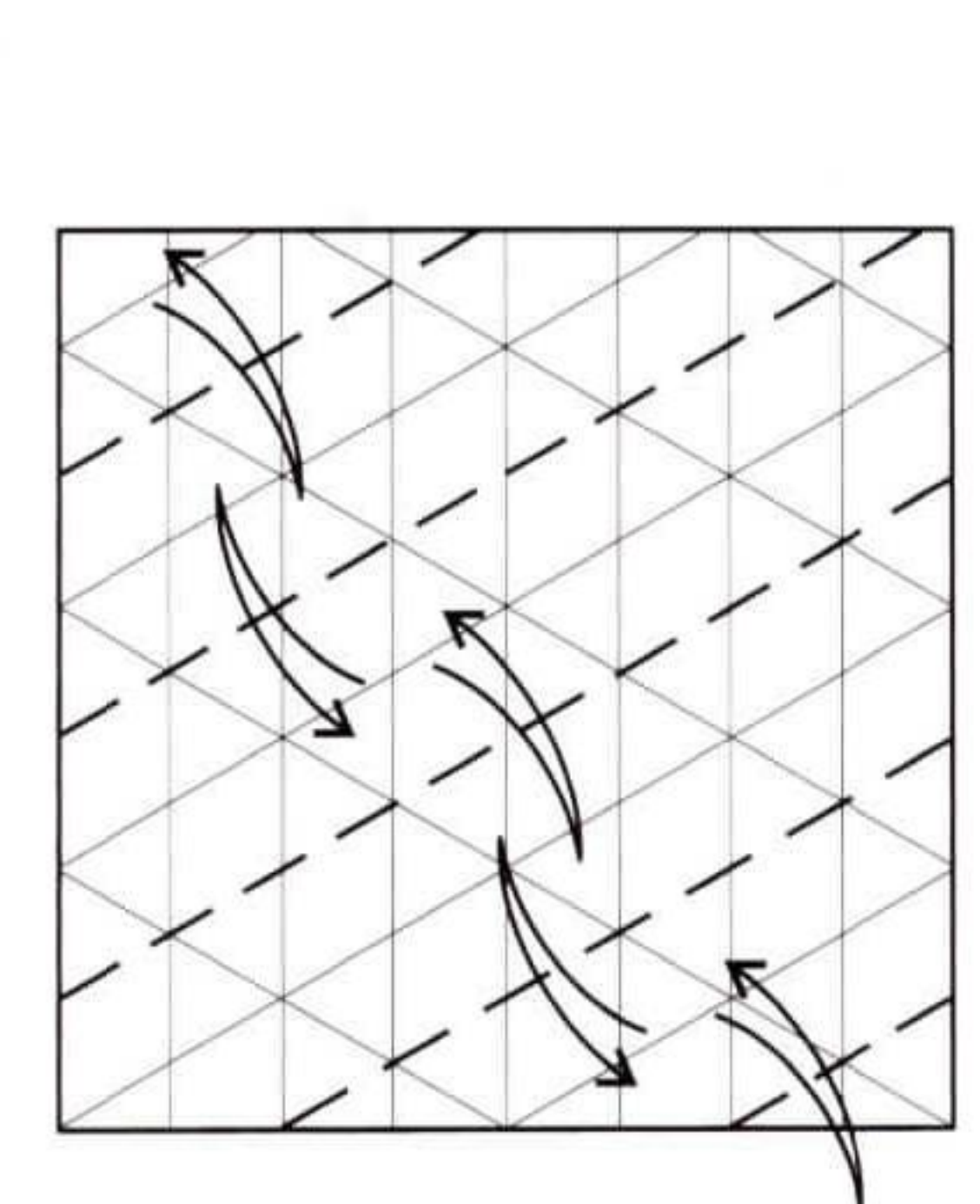

17 Fold and unfold between the diagonal creases made previously.

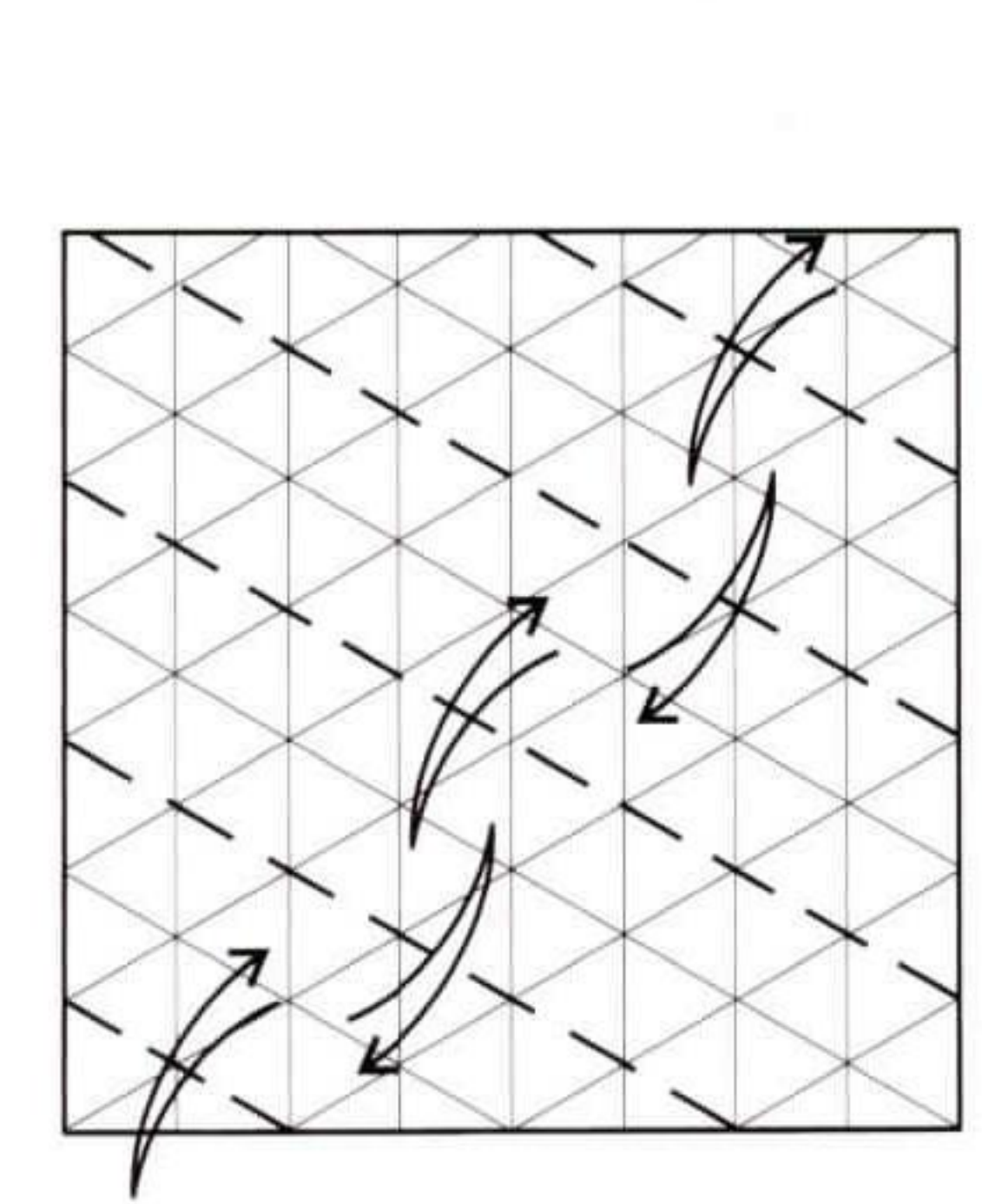

18 Repeat the process on the opposite side.

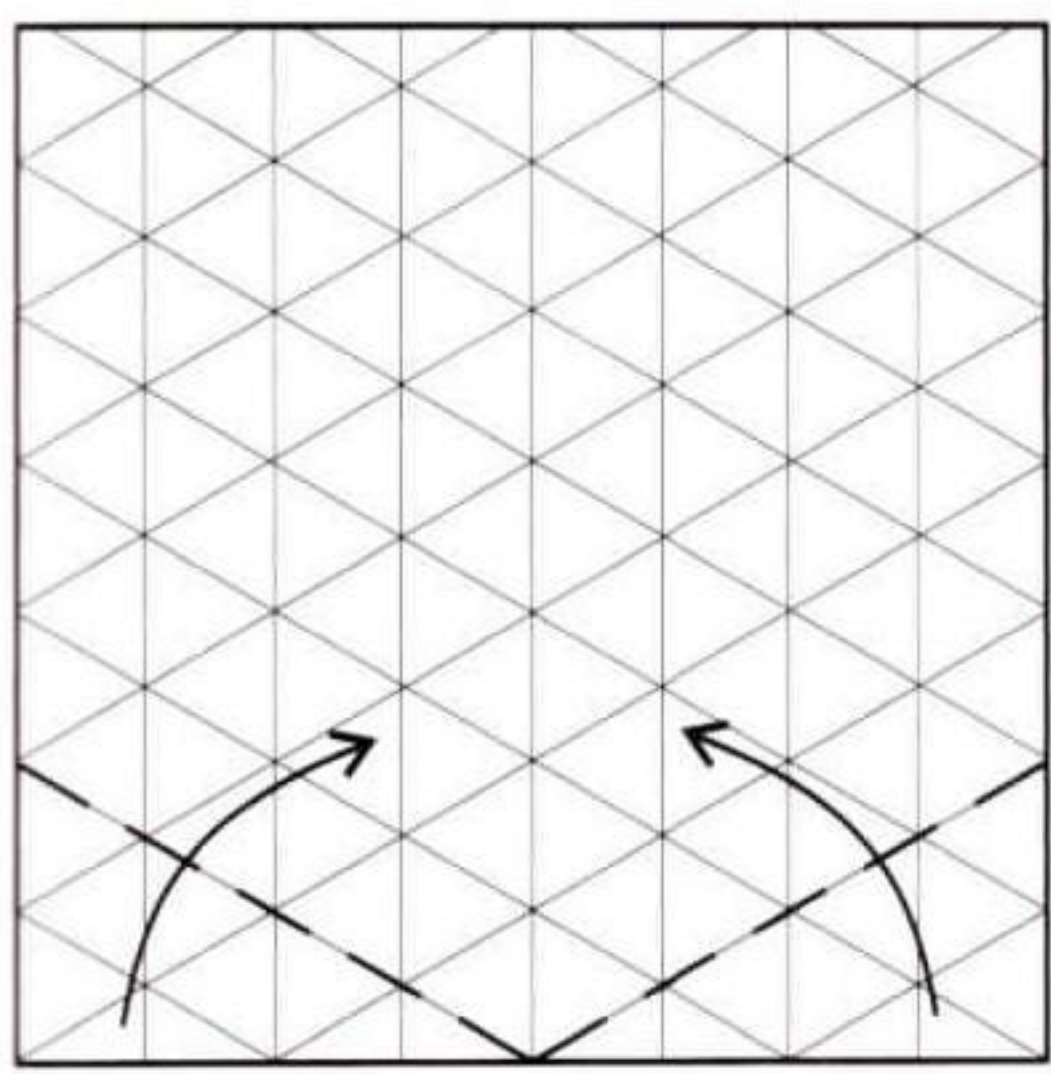

19 Fold the lower corners back up.

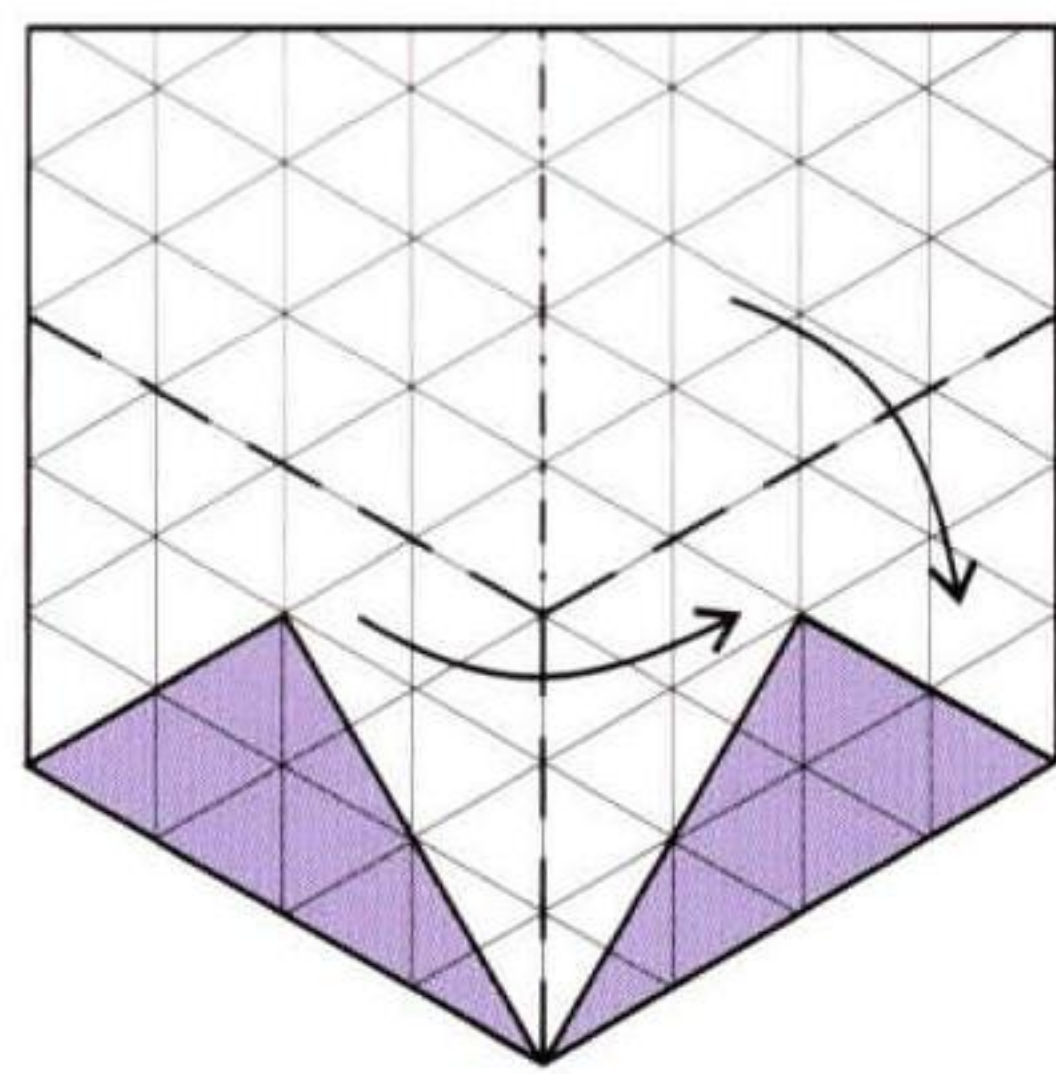

20 Fold the paper in half and at the same time reverse fold the upper section to the right.

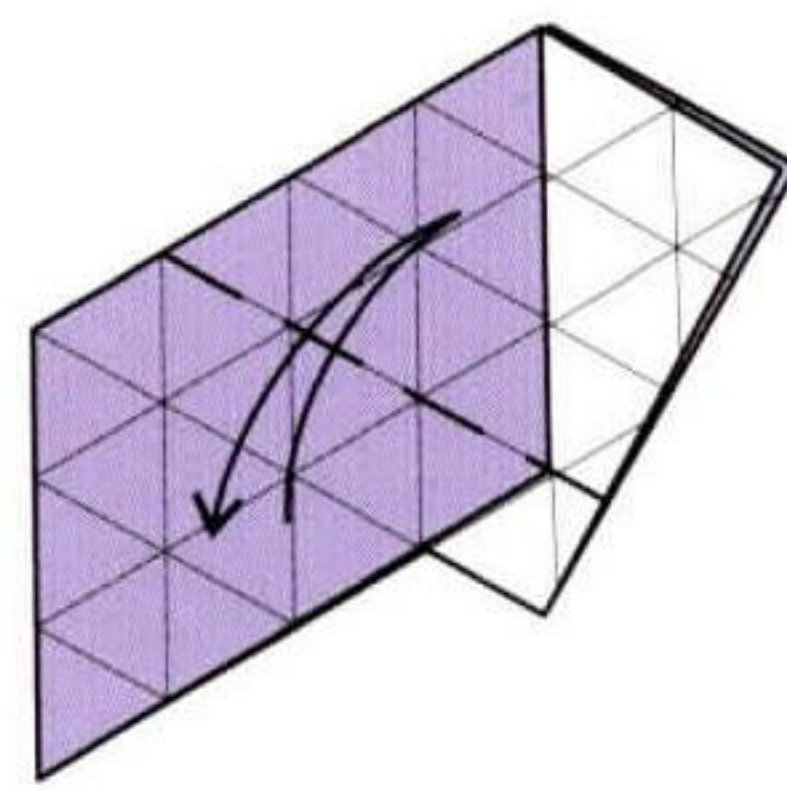

21 Fold the upper section over and back again.

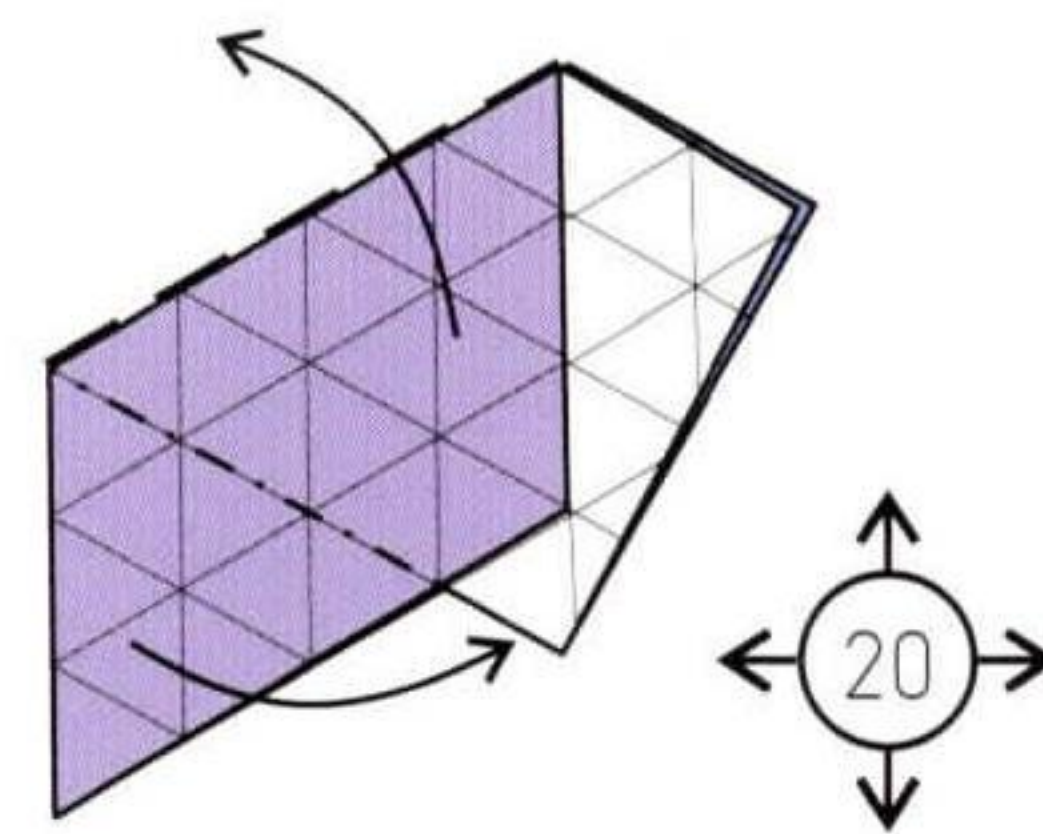

22 Unfold to step 20.

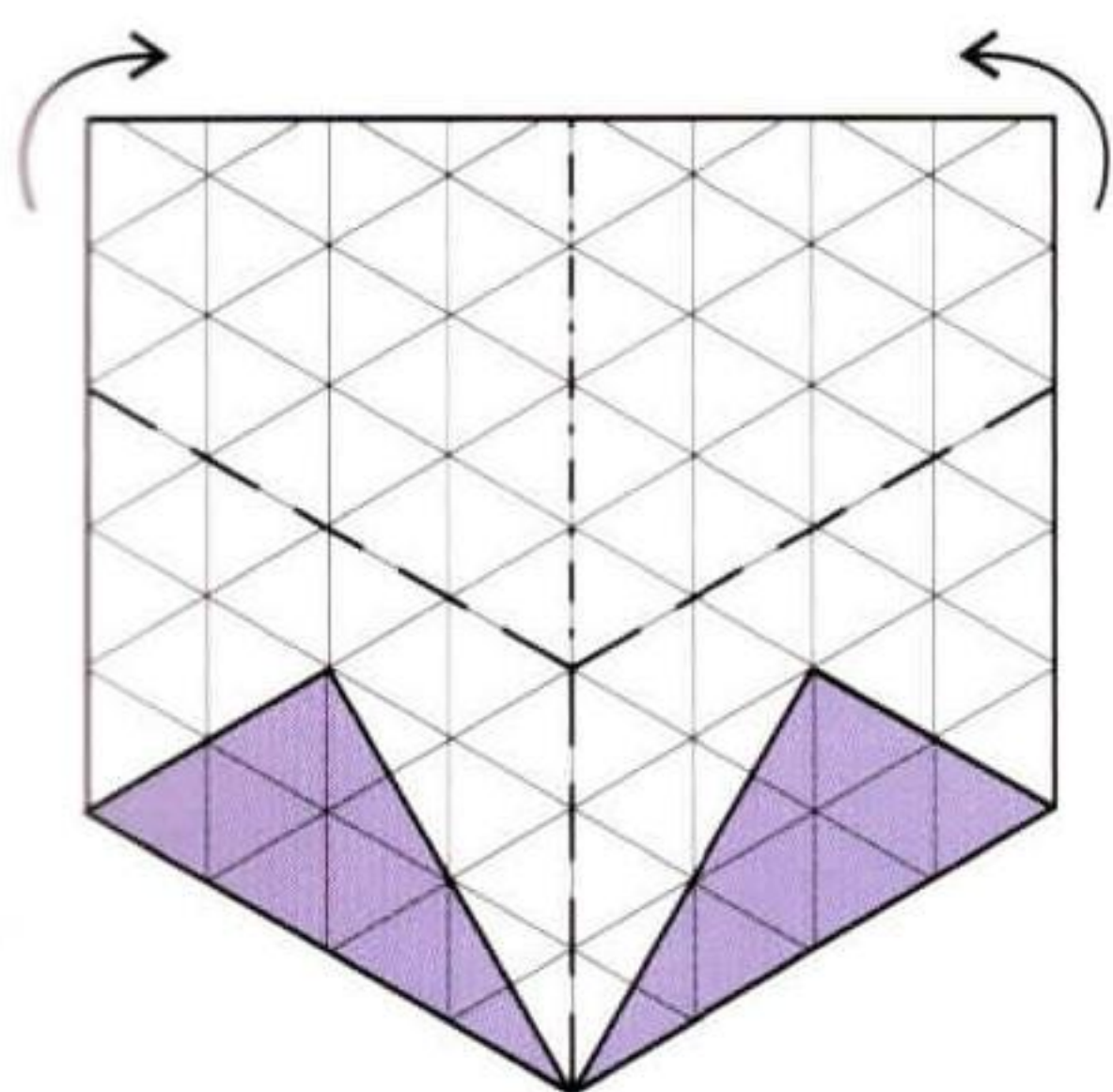

23 Fold the sides together and fold the upper section up along the creases made previously.

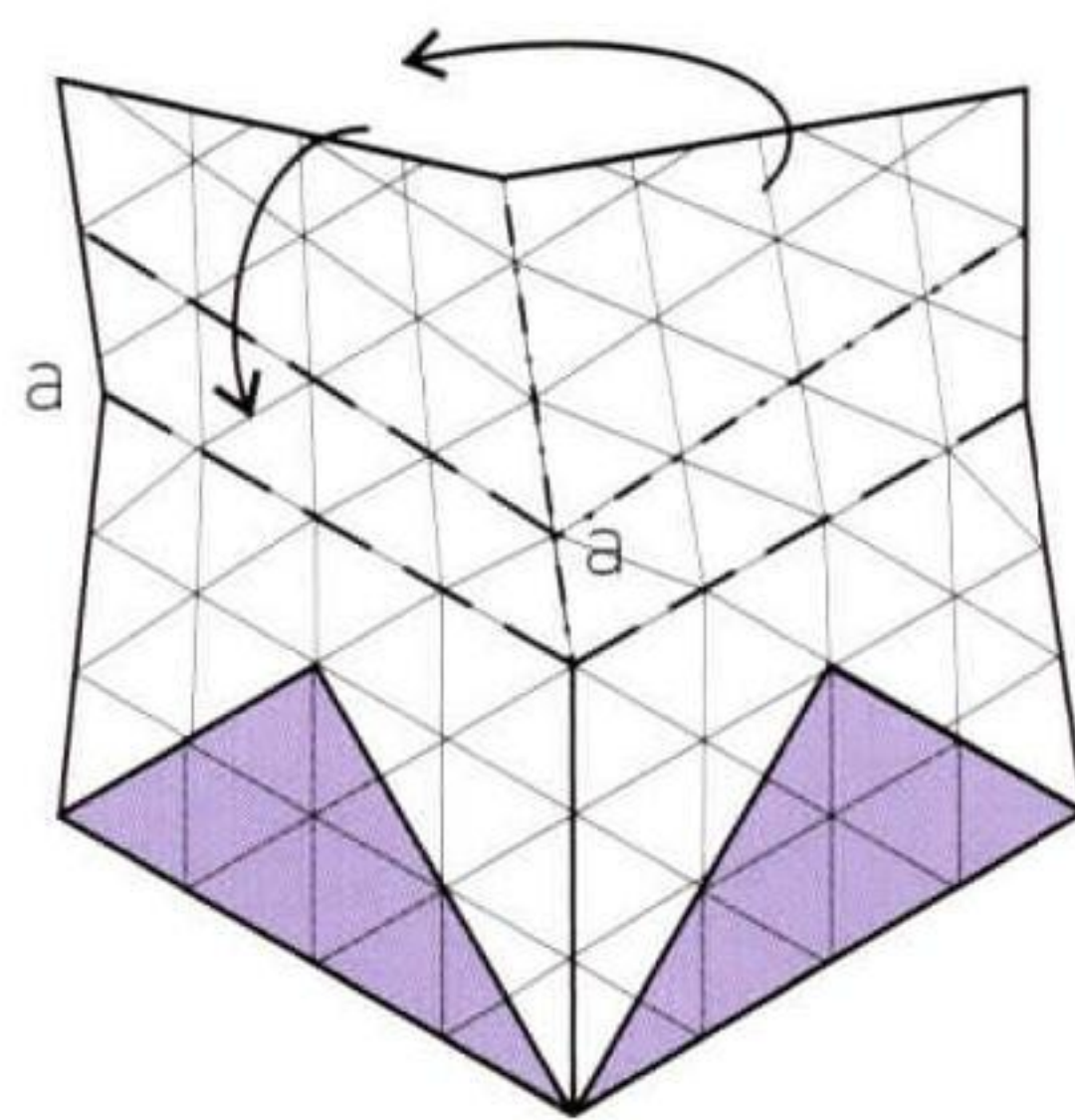

24 Fold the upper section in along (a-a) to make an inverted pyramid in the middle of the model.

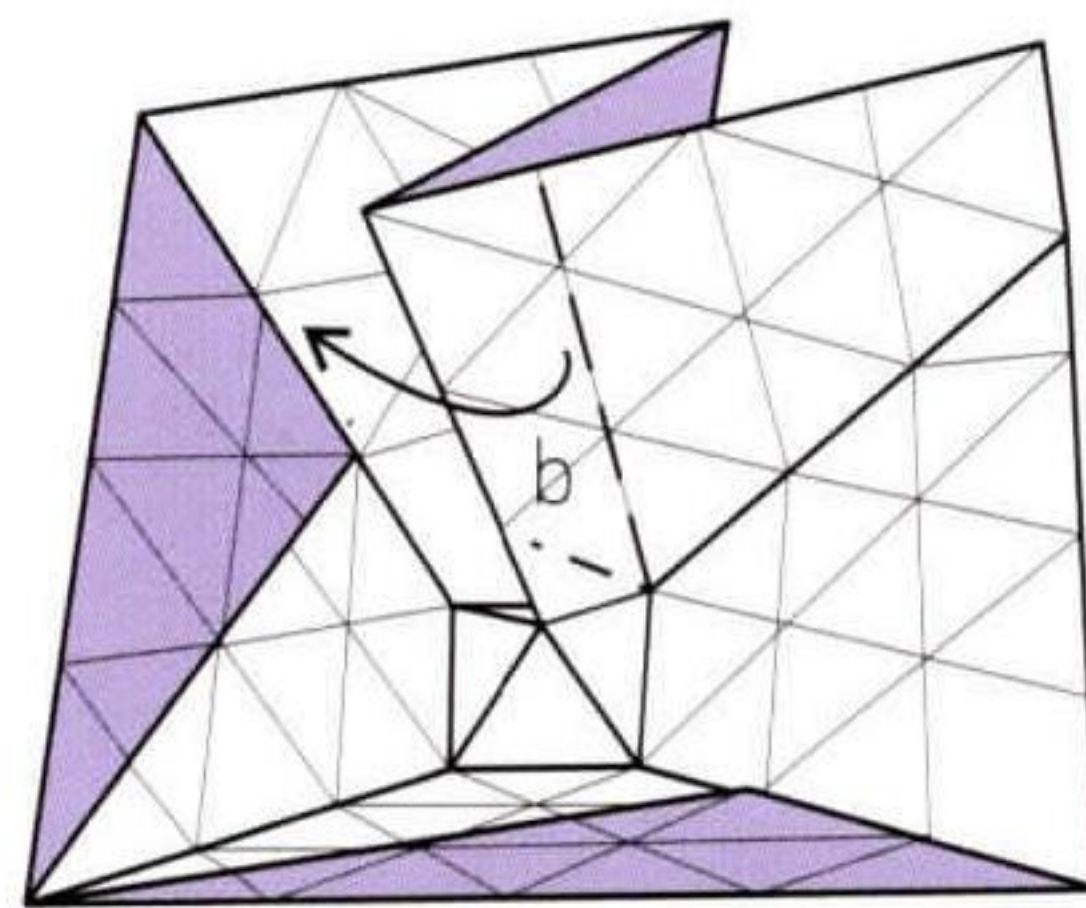

25 This shows the inverted pyramid in the centre. Continue folding the section (b) around it.

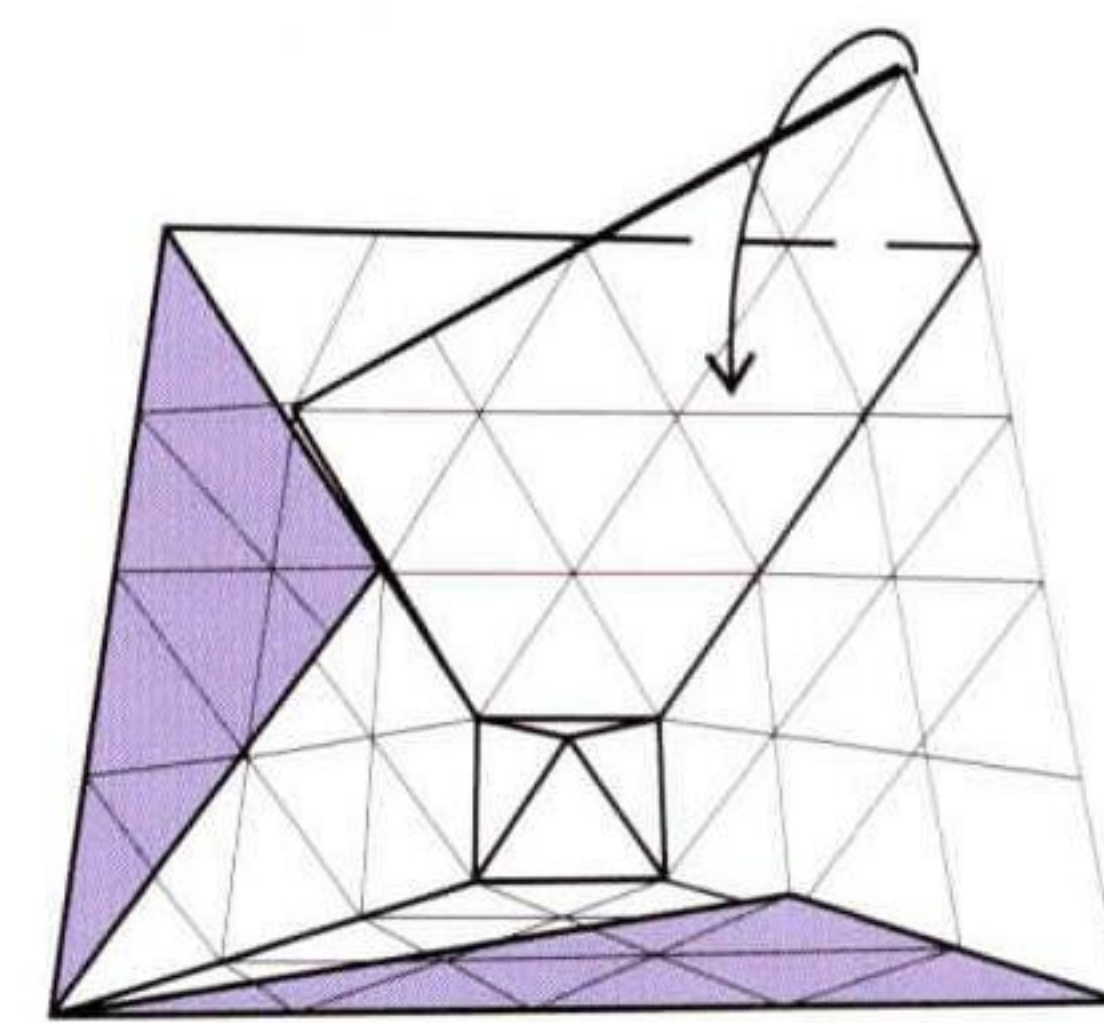

26 Fold the outer edge over and into the model.

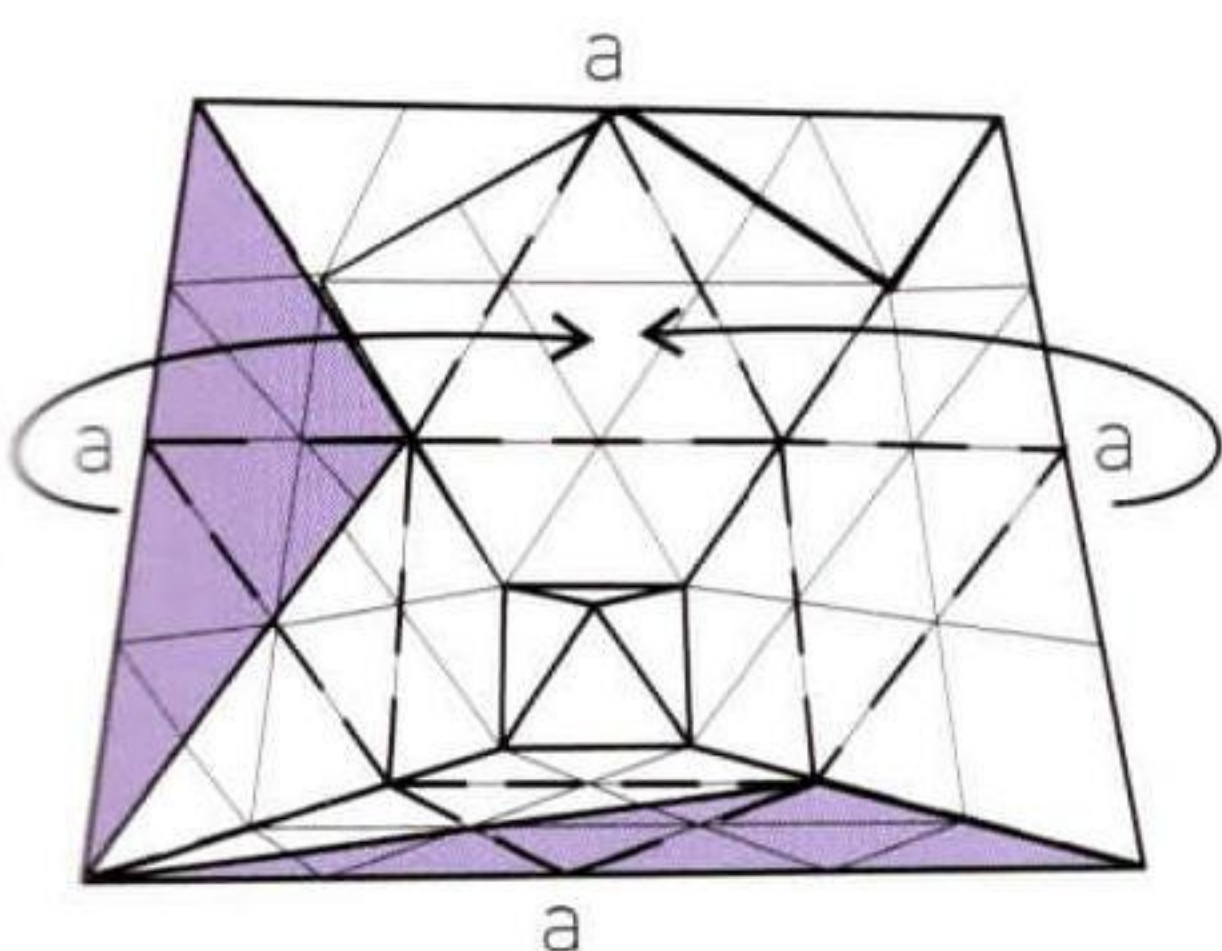

27 Fold the sides in, bringing all of the points (a) together.

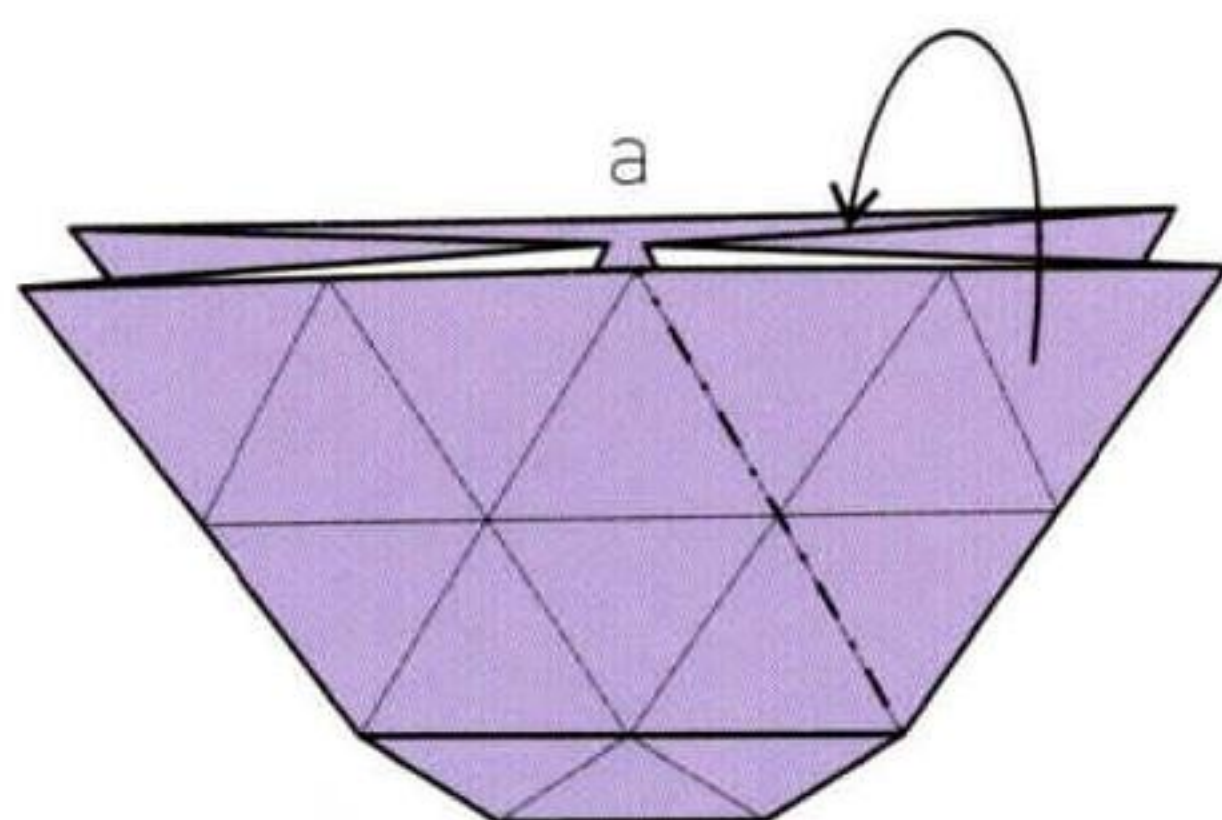

28 Fold one of the equilateral triangles into the other. One should tuck fully inside the other.



29 Fold the triangles on the opposite side into each other.

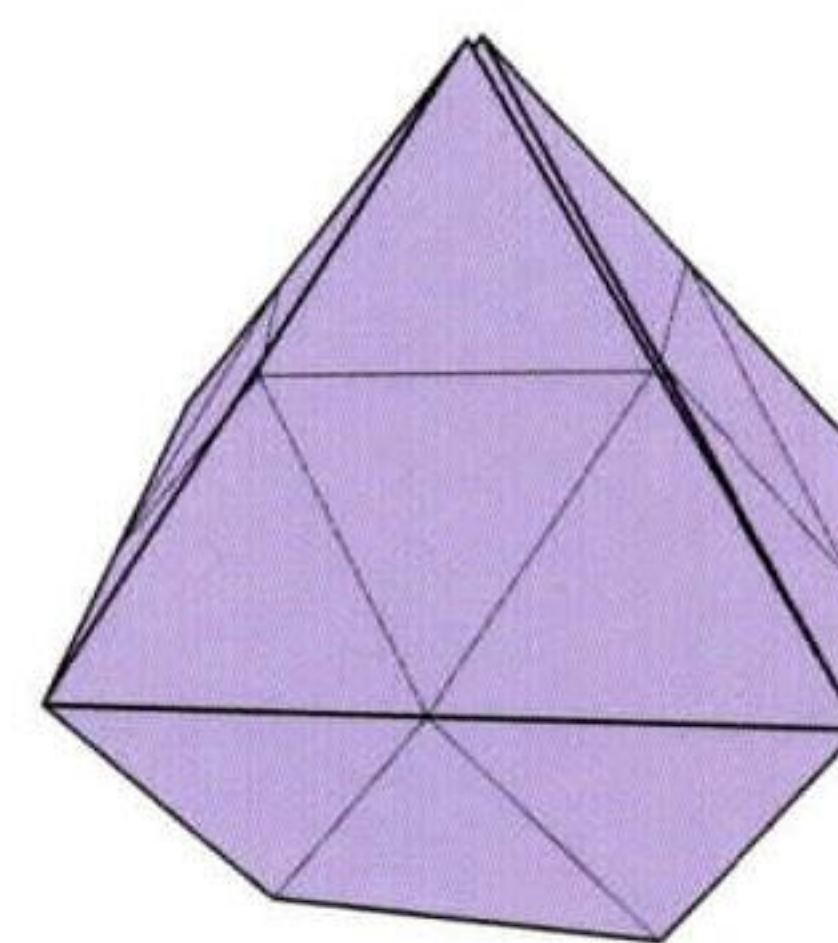

30 Complete.

Sunken Pyramid

*

This project starts with the geometry of a square. The sides are formed by three-quarters of the square folding together. The inverted point is part of the look of the model on the outside. It also works inside the model, applying an internal tension that adds rigidity.

18 X 18CM (7 X 7IN)

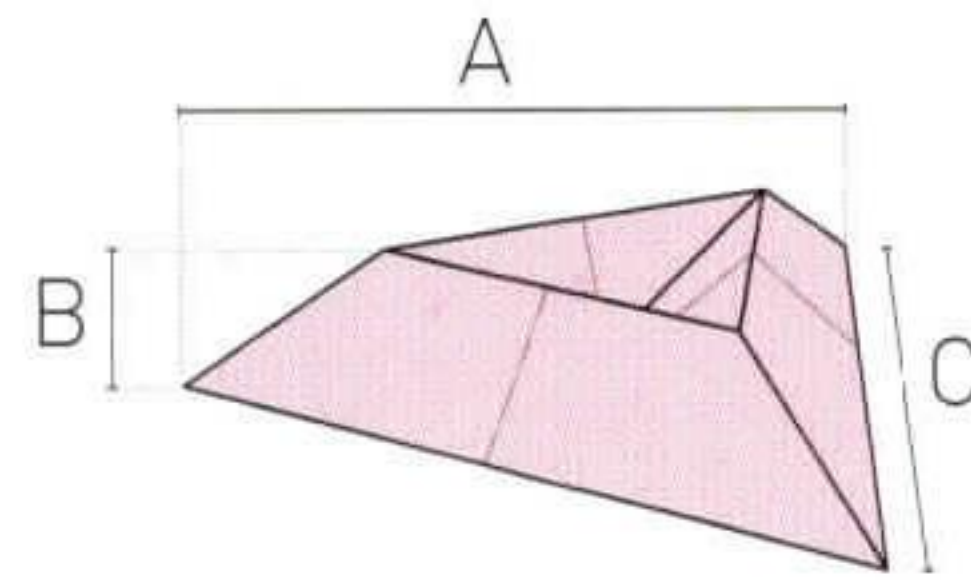
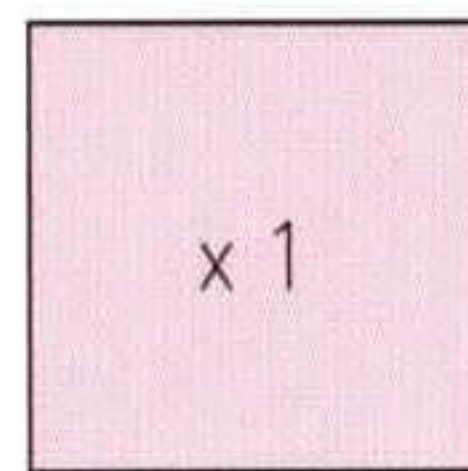

A	11.4cm	(4½in)
B	2.9cm	(1in)
C	11.4cm	(4½in)

START WITH A SQUARE, COLOURED SIDE UP.

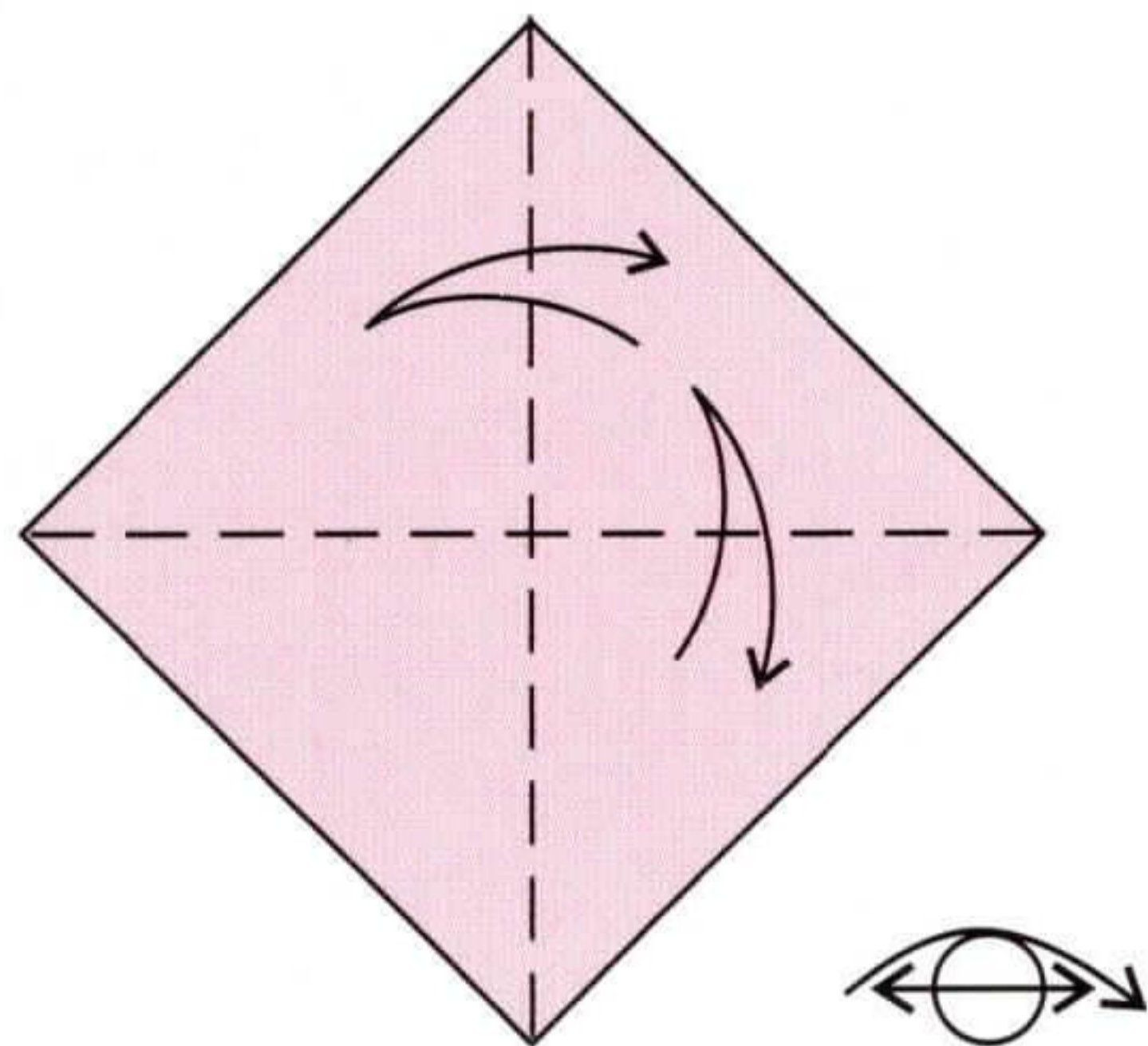

- 1 Fold and unfold the square diagonally along both axes. Then turn the paper over left to right.

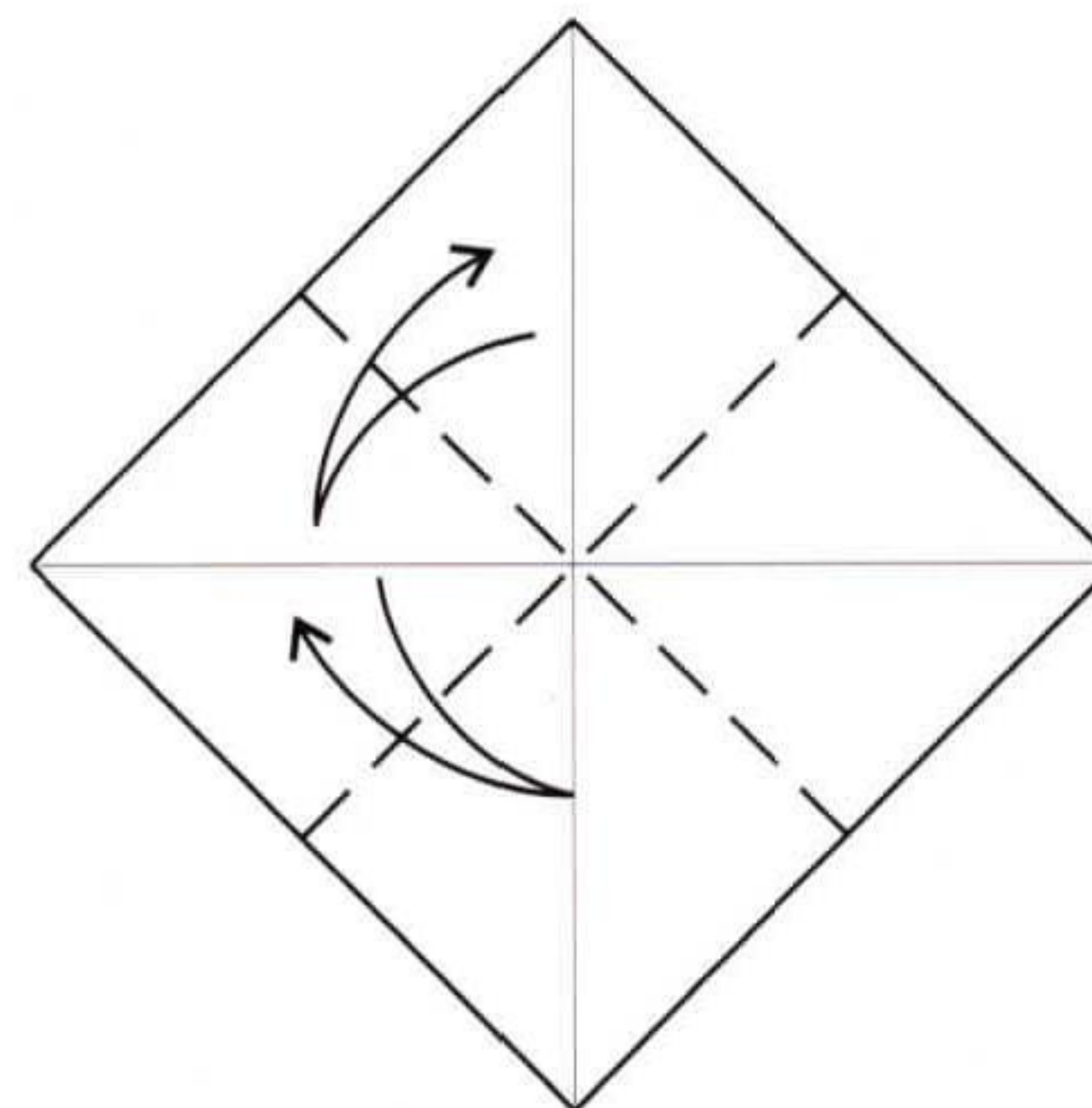

- 2 Fold and unfold along the middle of the paper on both axes.

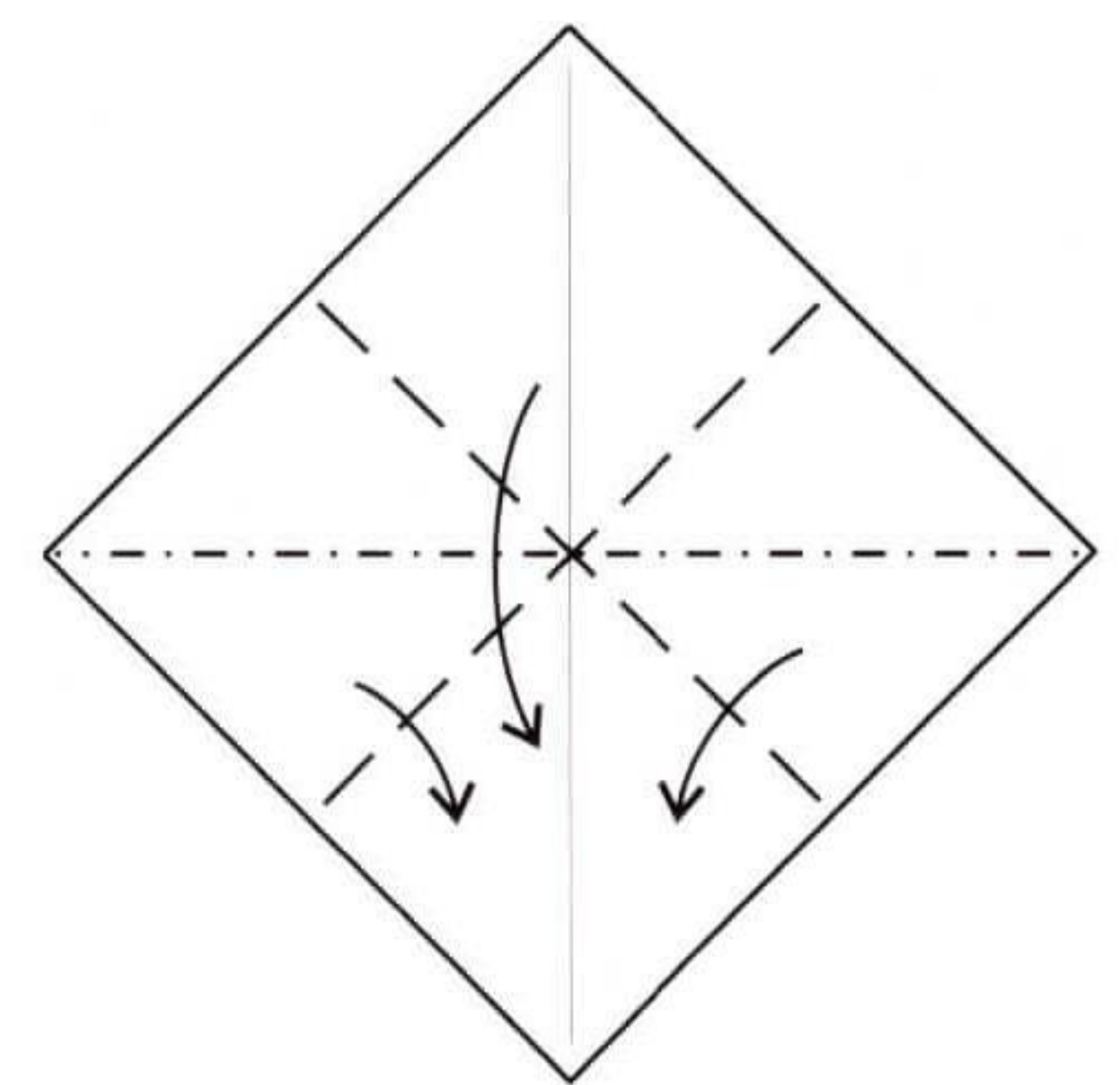

- 3 Fold the upper point down and fold the outer corners in, making a preliminary base.

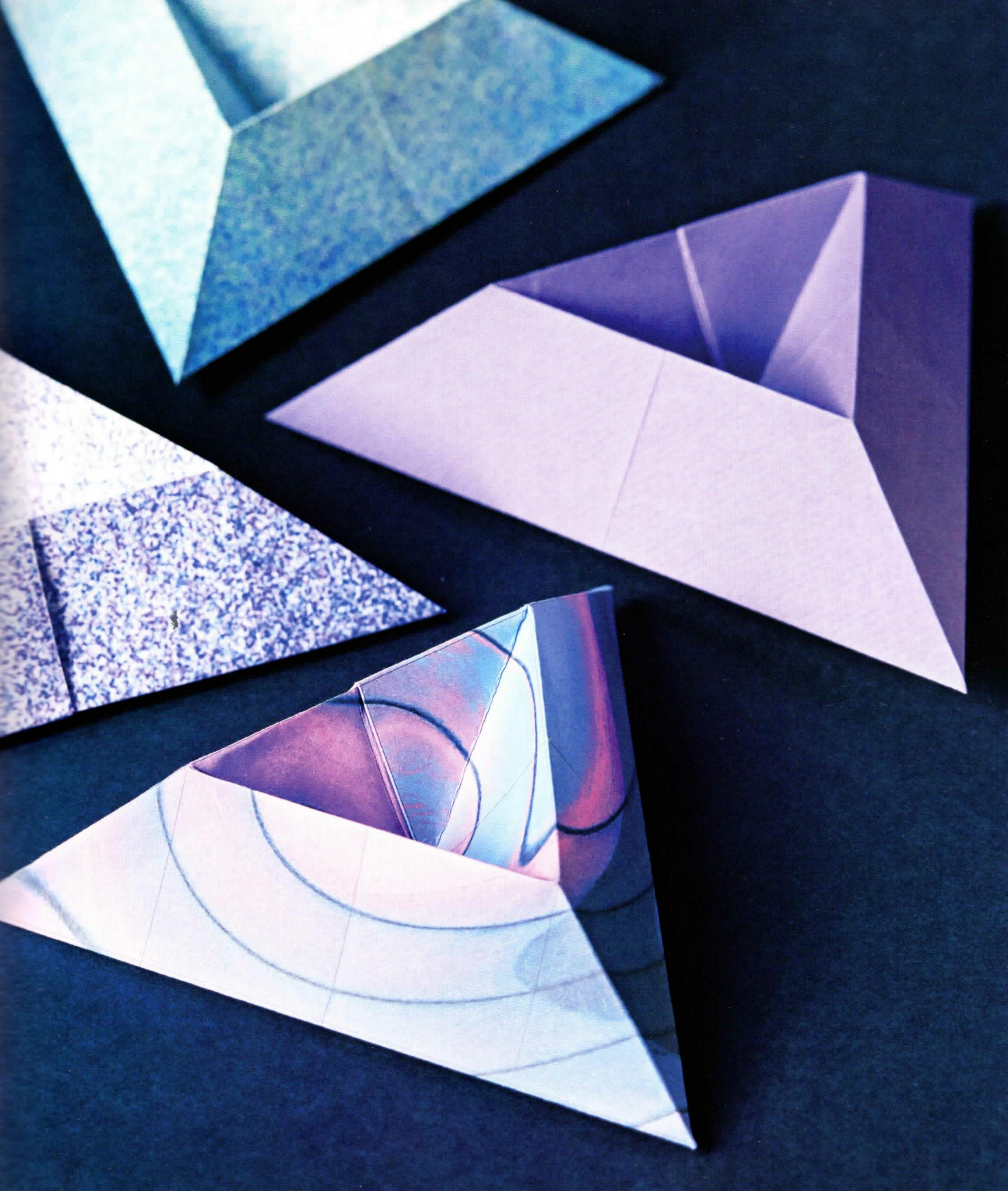

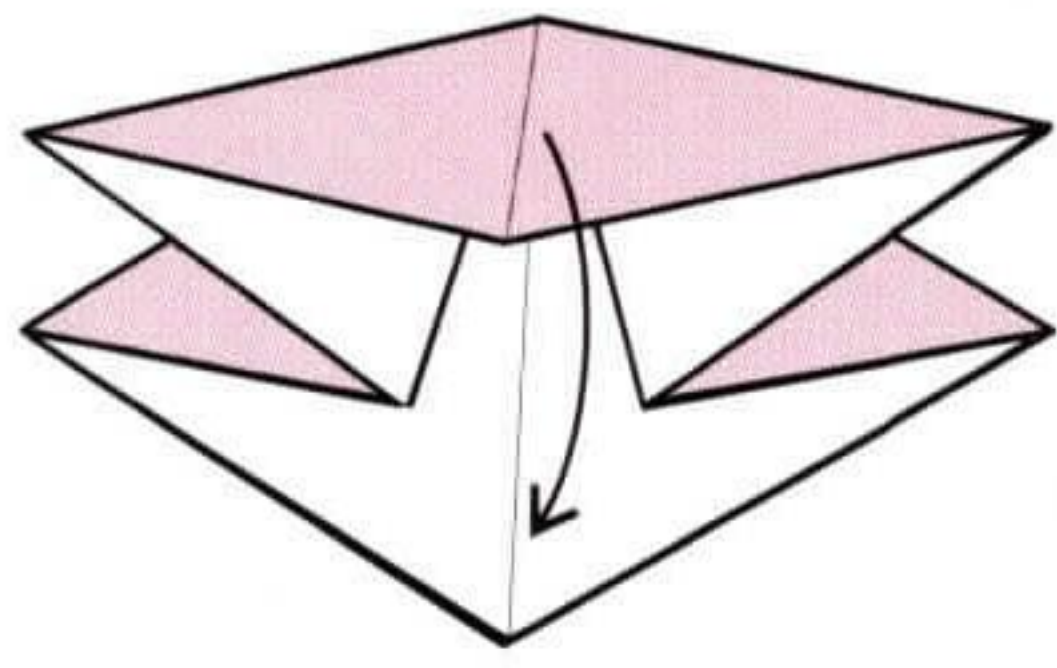

4 Fold in progress.

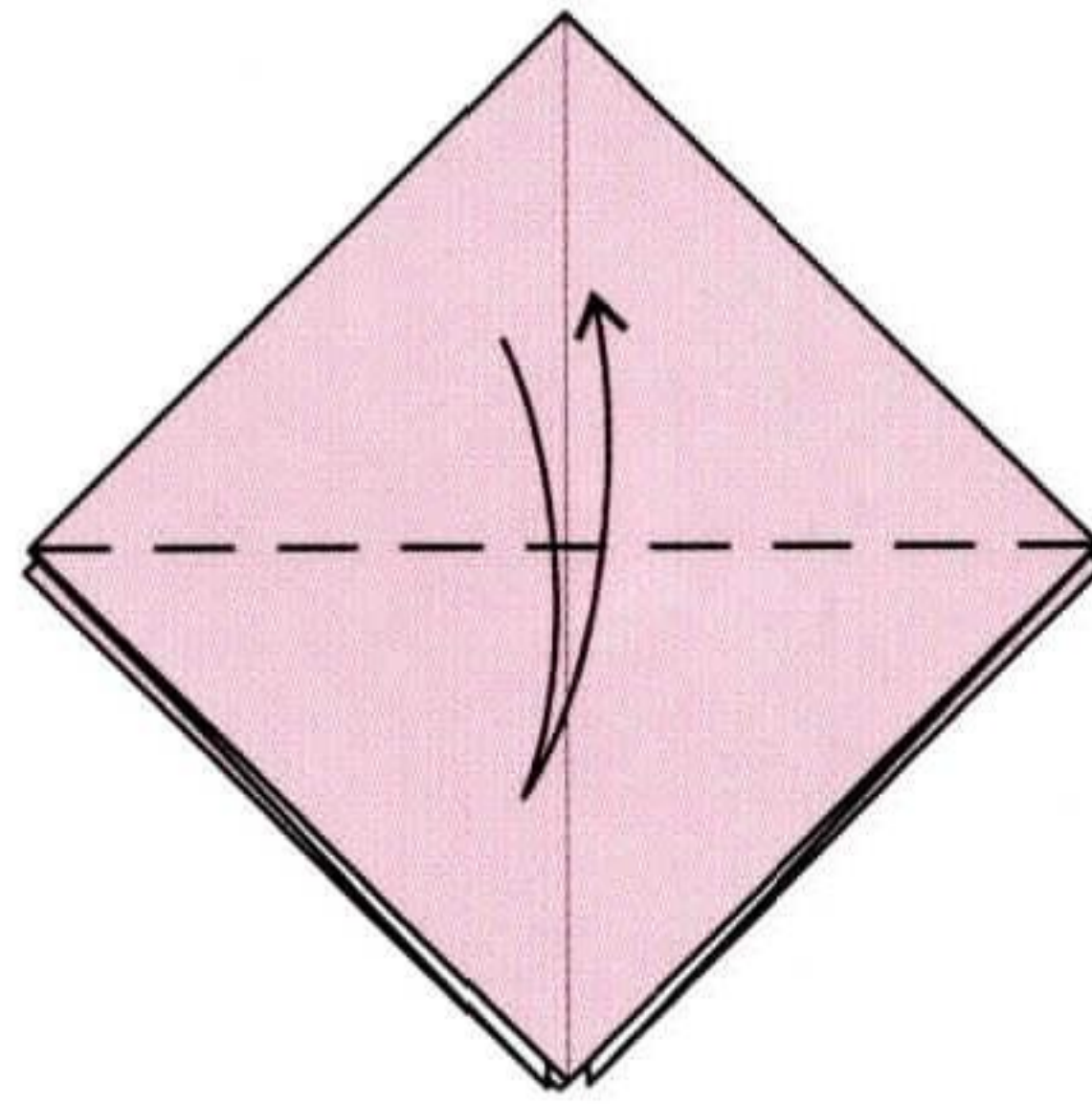

5 Fold the lower corner up and down again, along the middle.

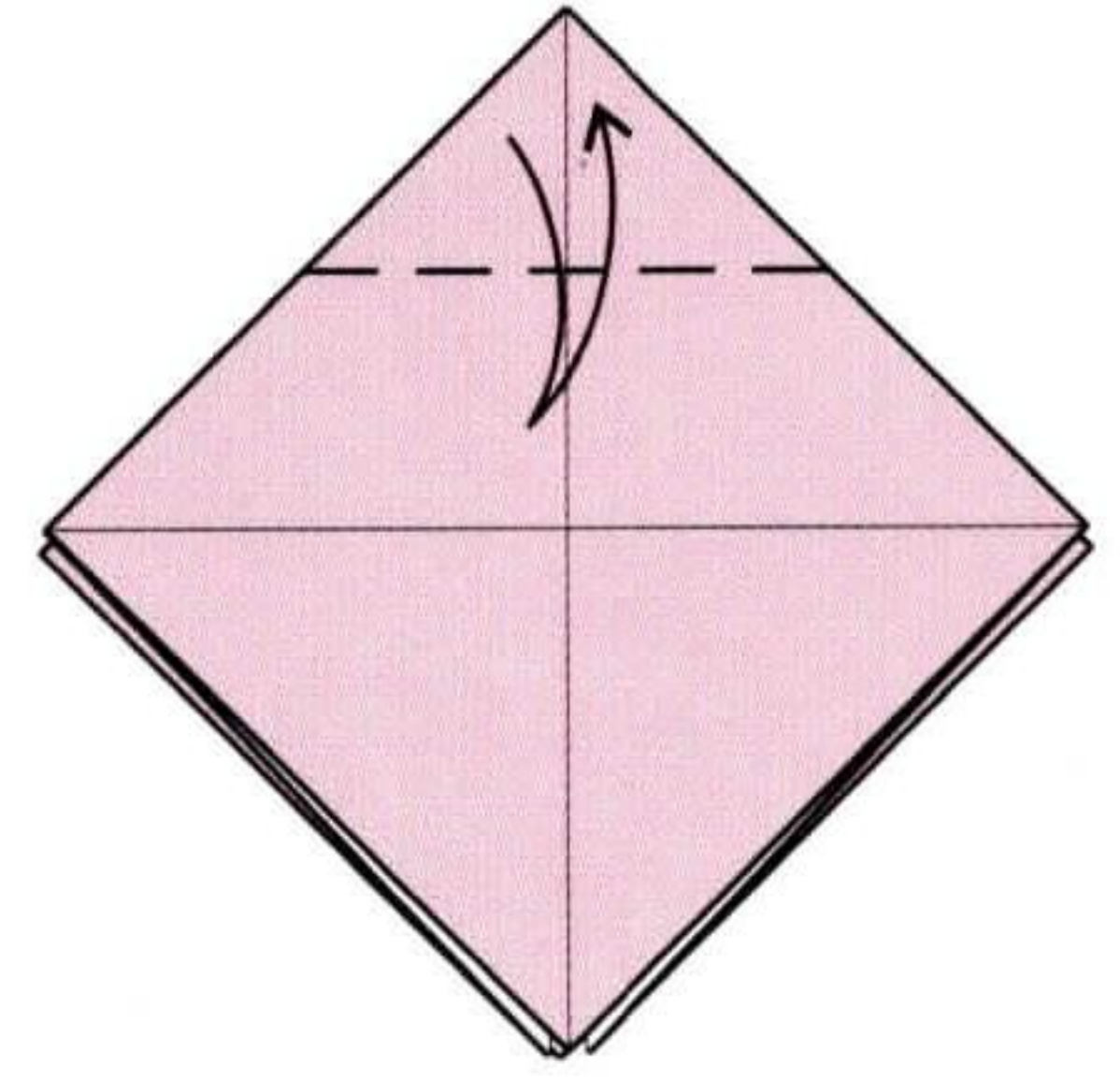

6 Fold and unfold the upper corner to the middle crease.

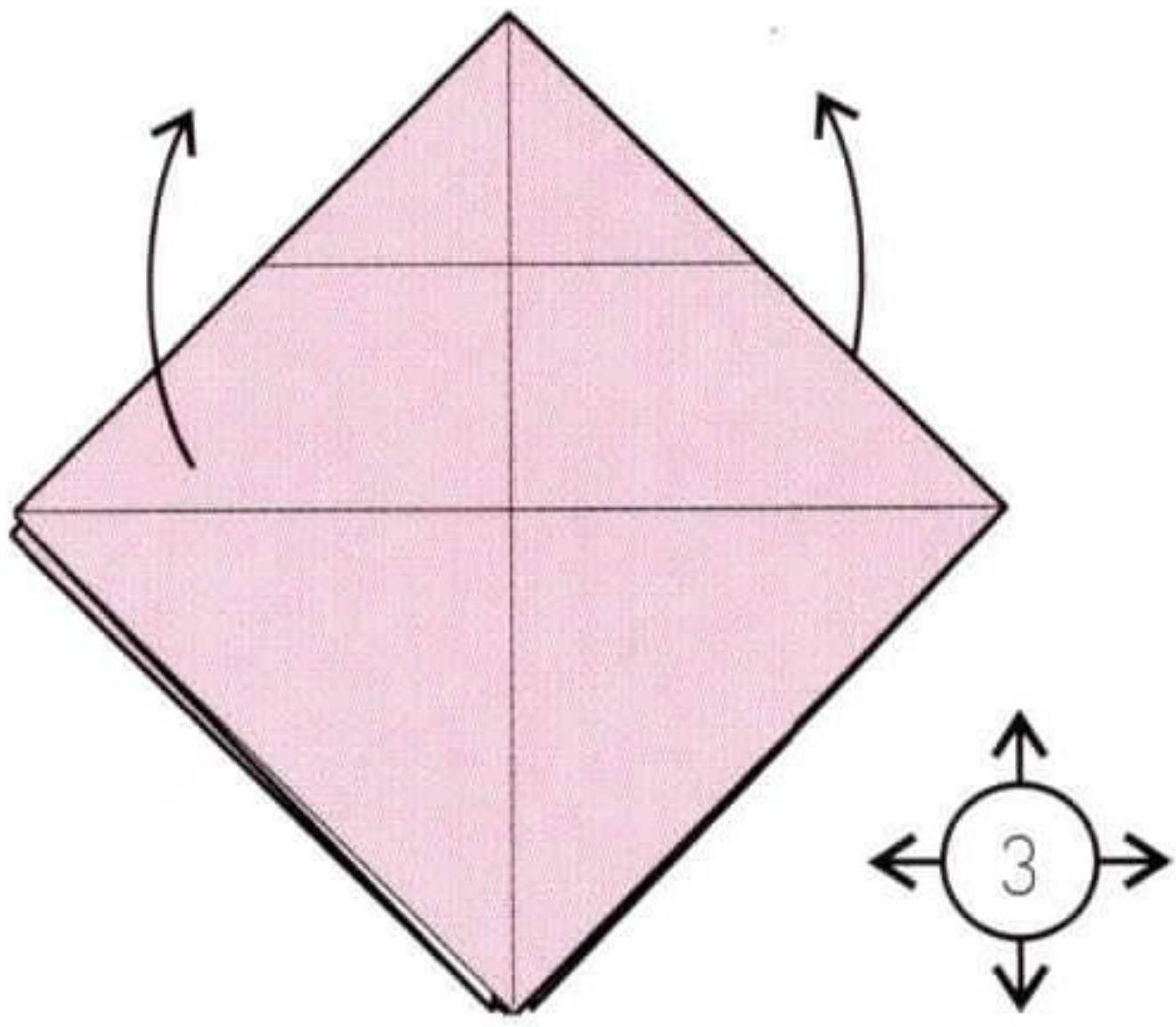

7 Unfold back to a square (to step 3).

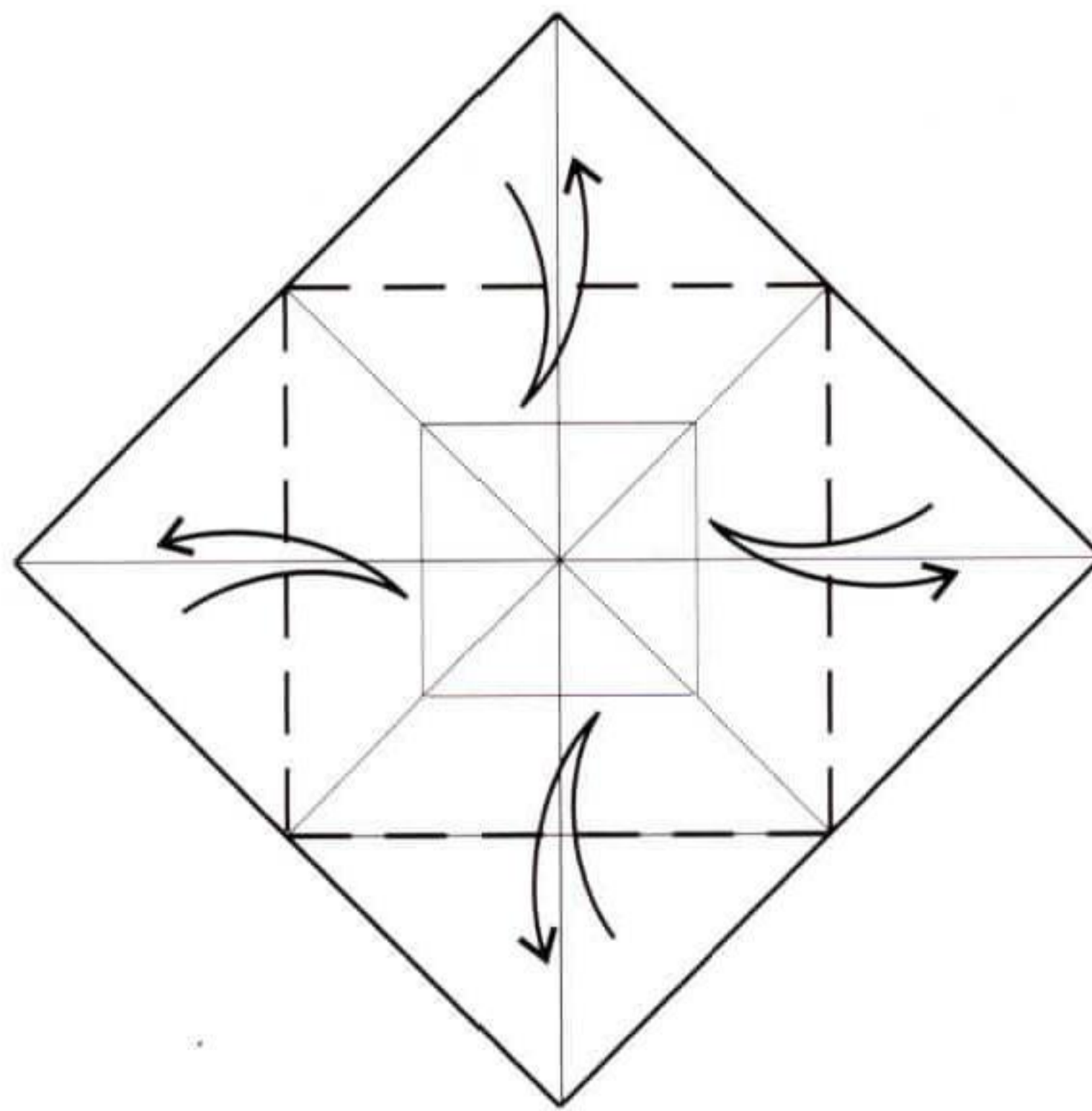

8 Fold the corners in to the middle and unfold.

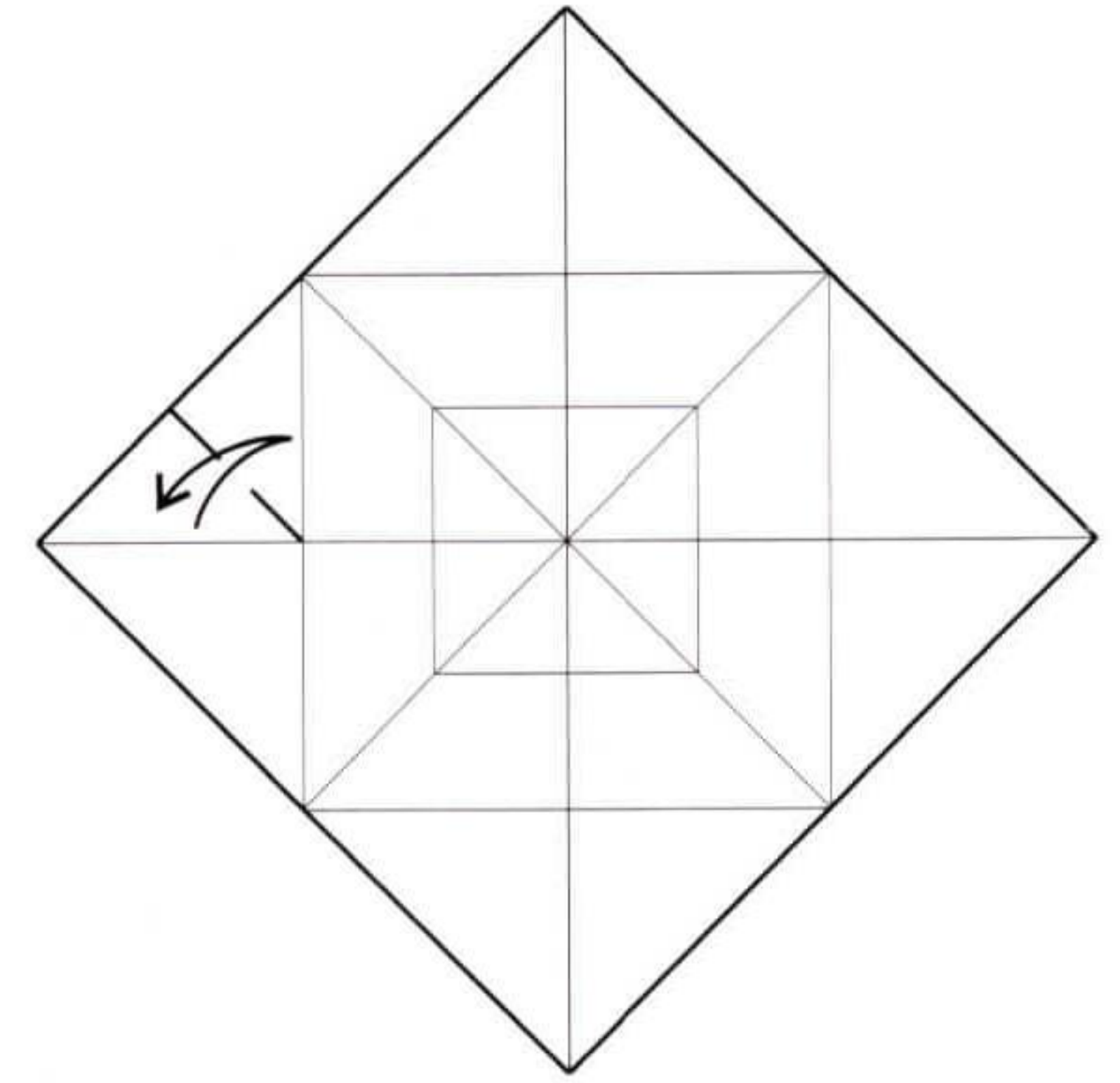

9 Fold and unfold the outer edge diagonally.

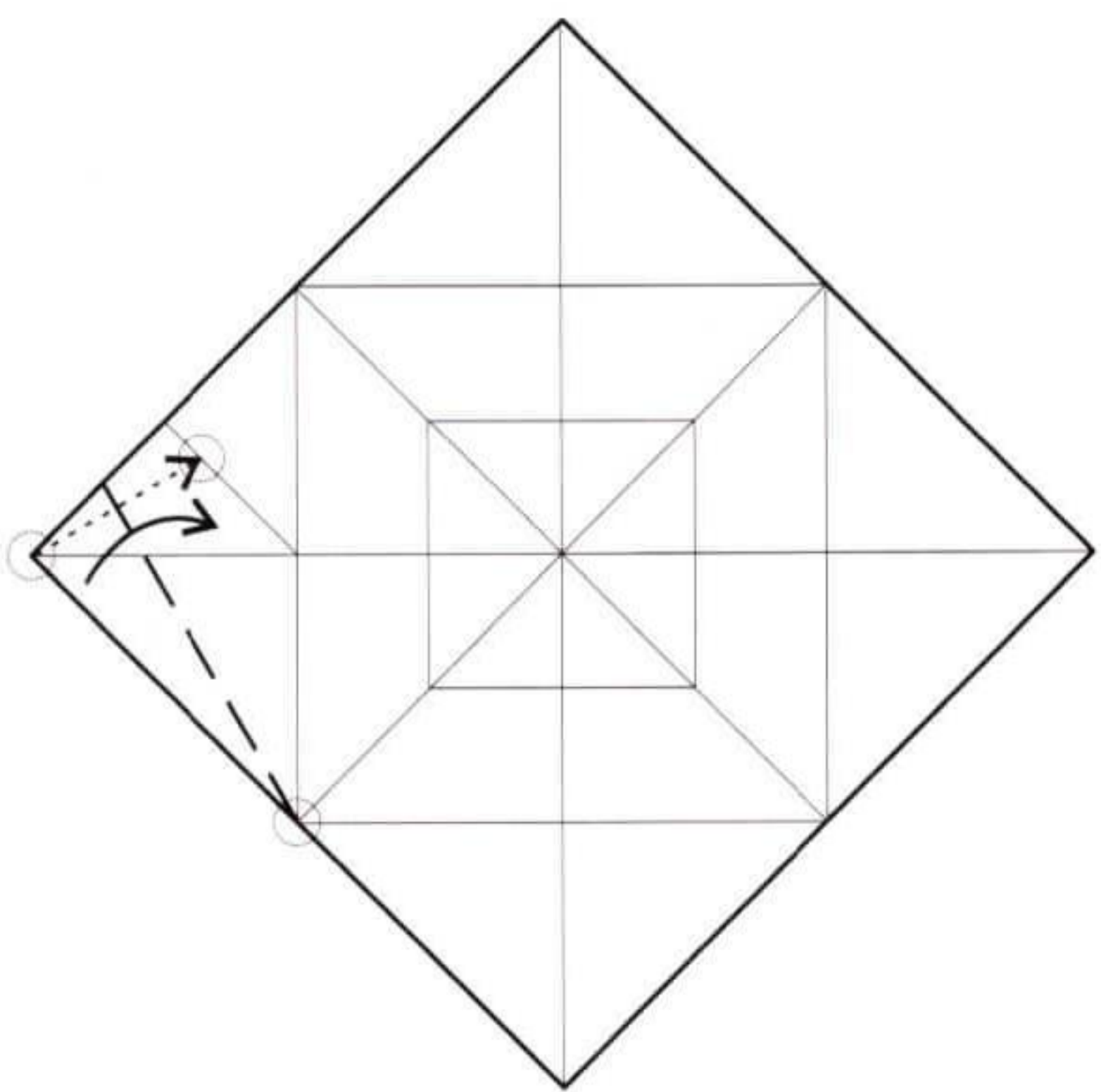

10 Fold the left corner in, to touch the crease made previously.

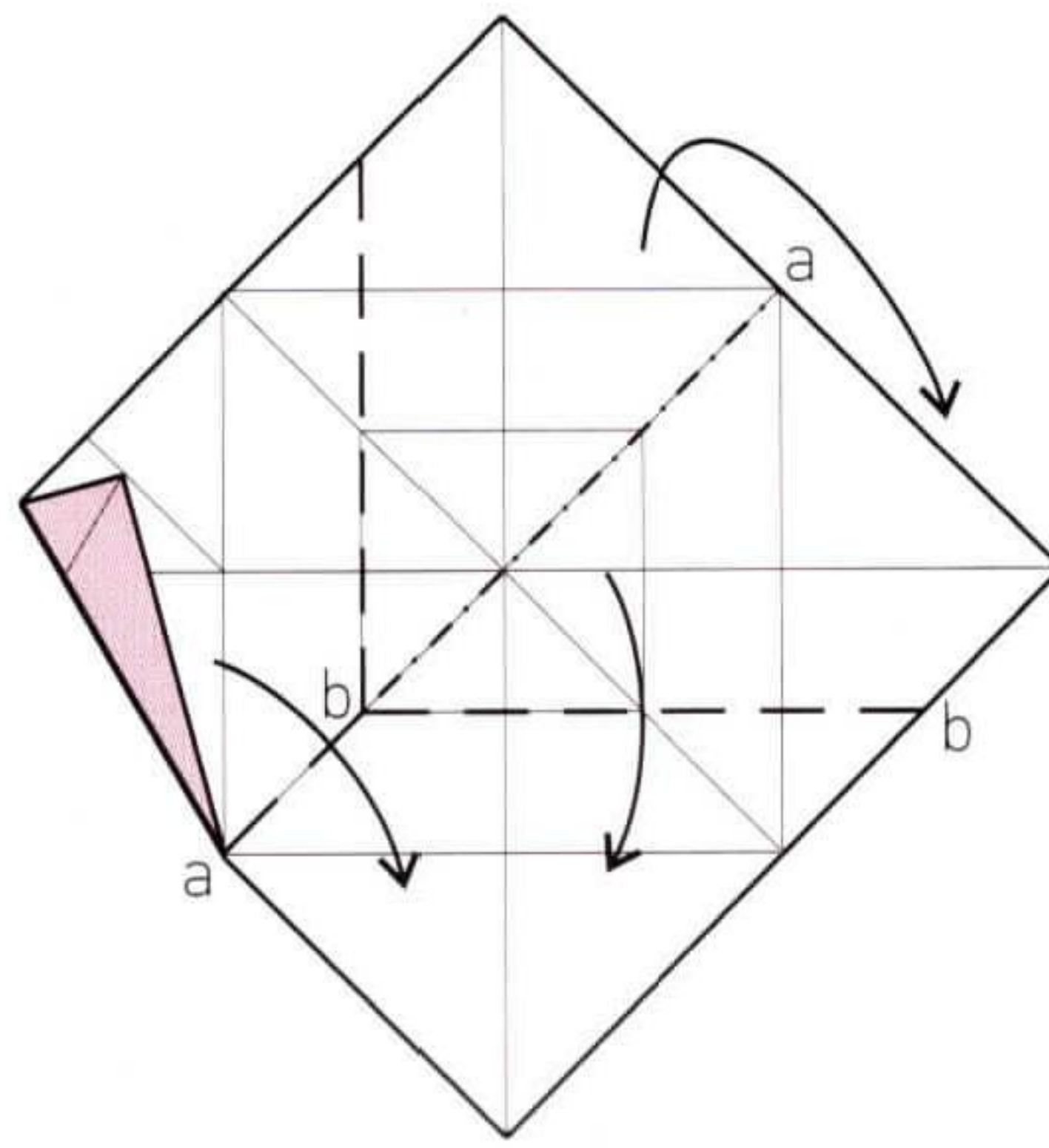

11 Fold the model in half along (a-a). At the same time fold down the line (b-b) to remake the model along the creases made previously.

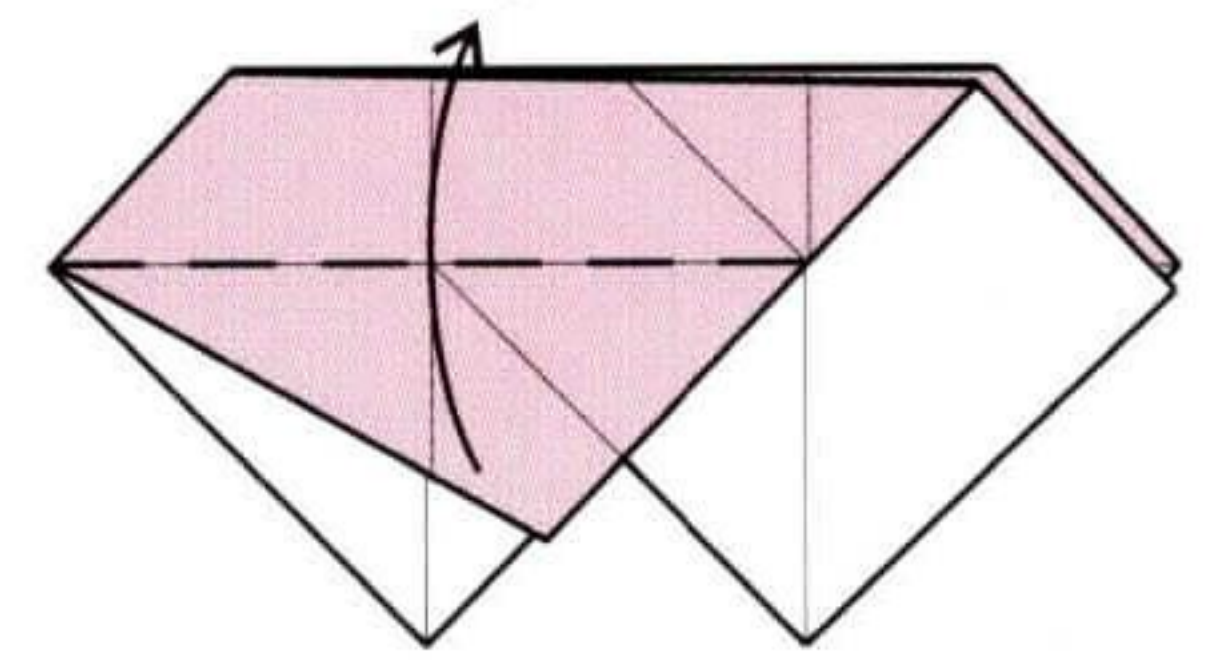

12 Fold up the corner.

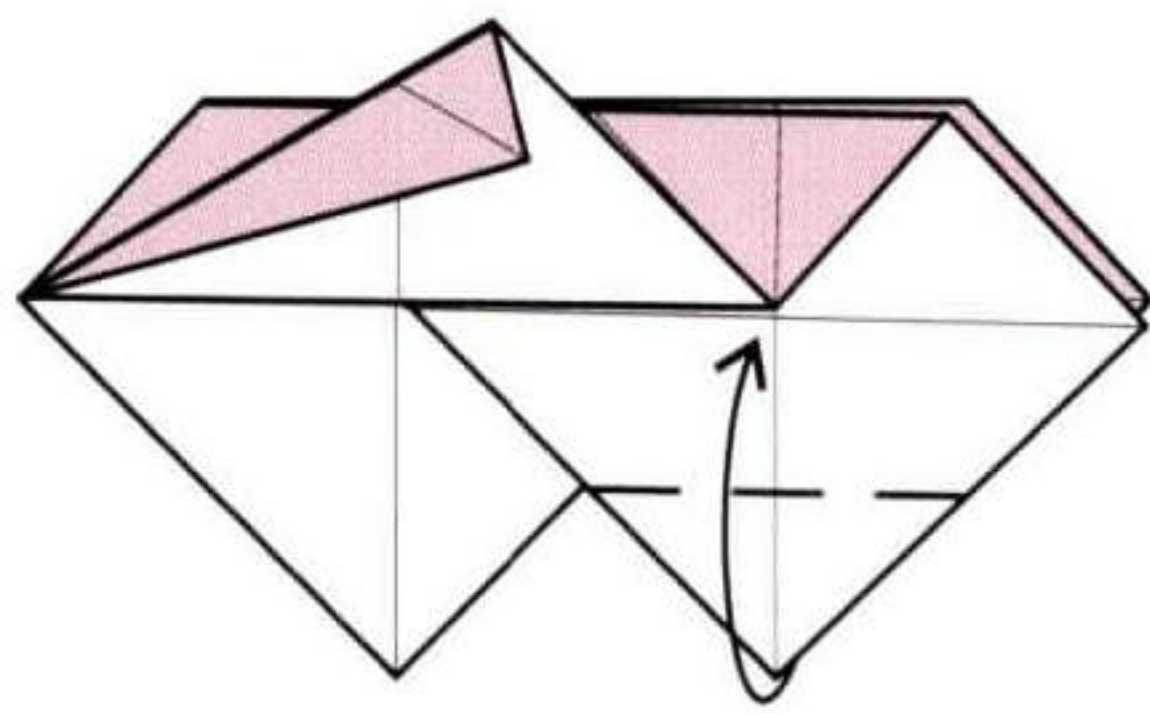

13 Fold up the corner of the lower section.

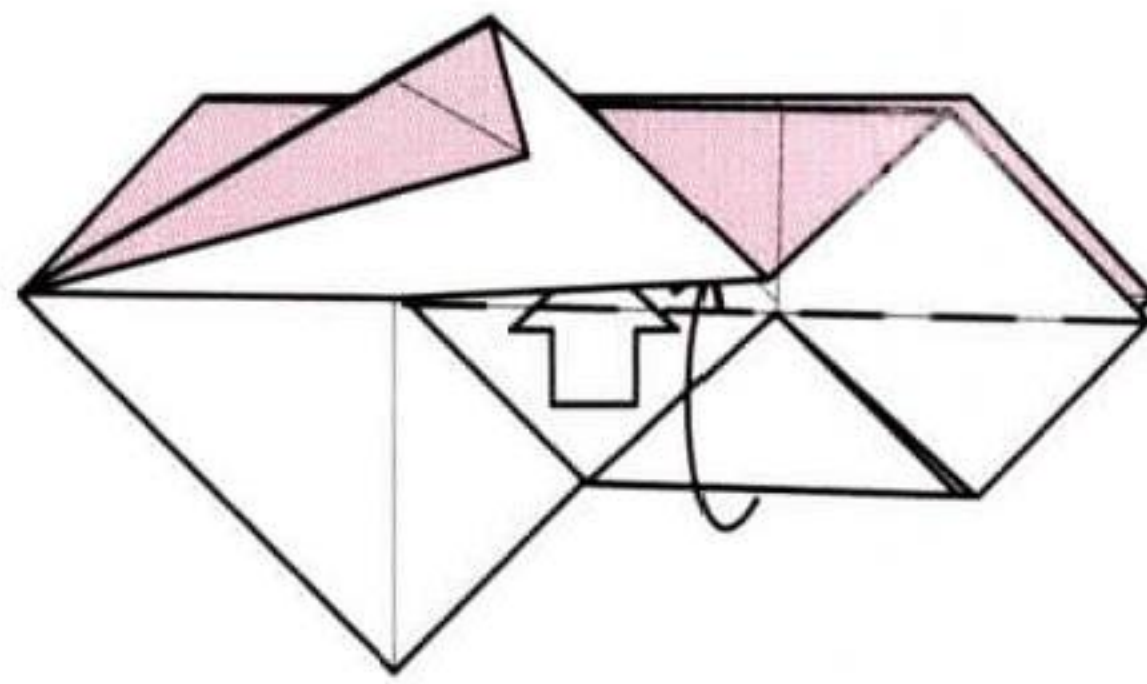

14 Fold the lower edge up and into the model above.

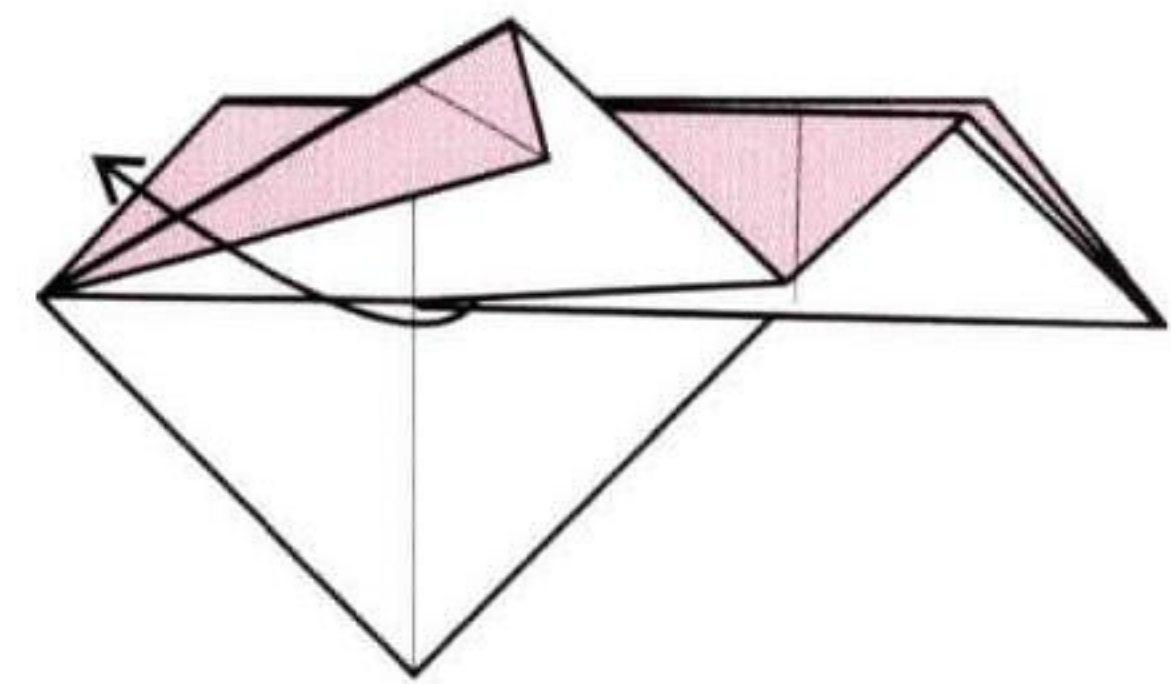

15 Open out the model by folding the upper edges to the right.

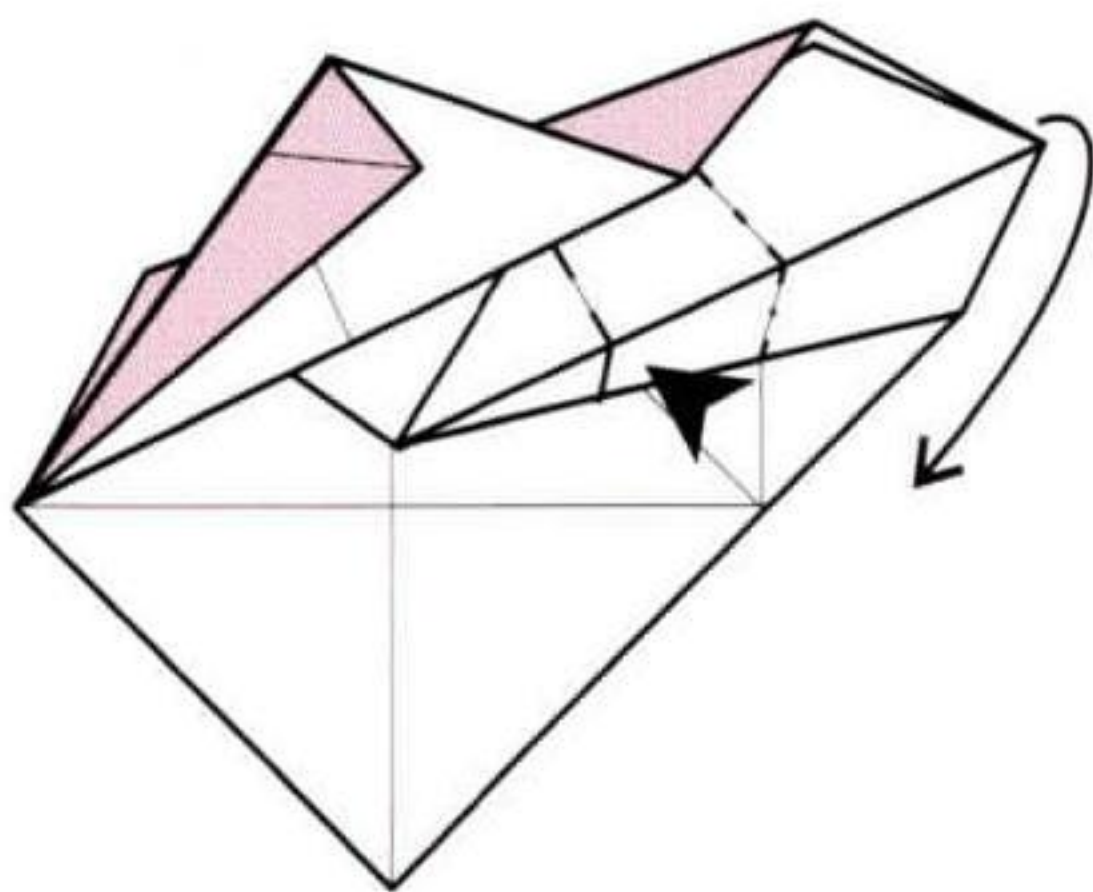

16 Having opened out the model, push the paper inwards where indicated to form the third edge of a triangle.

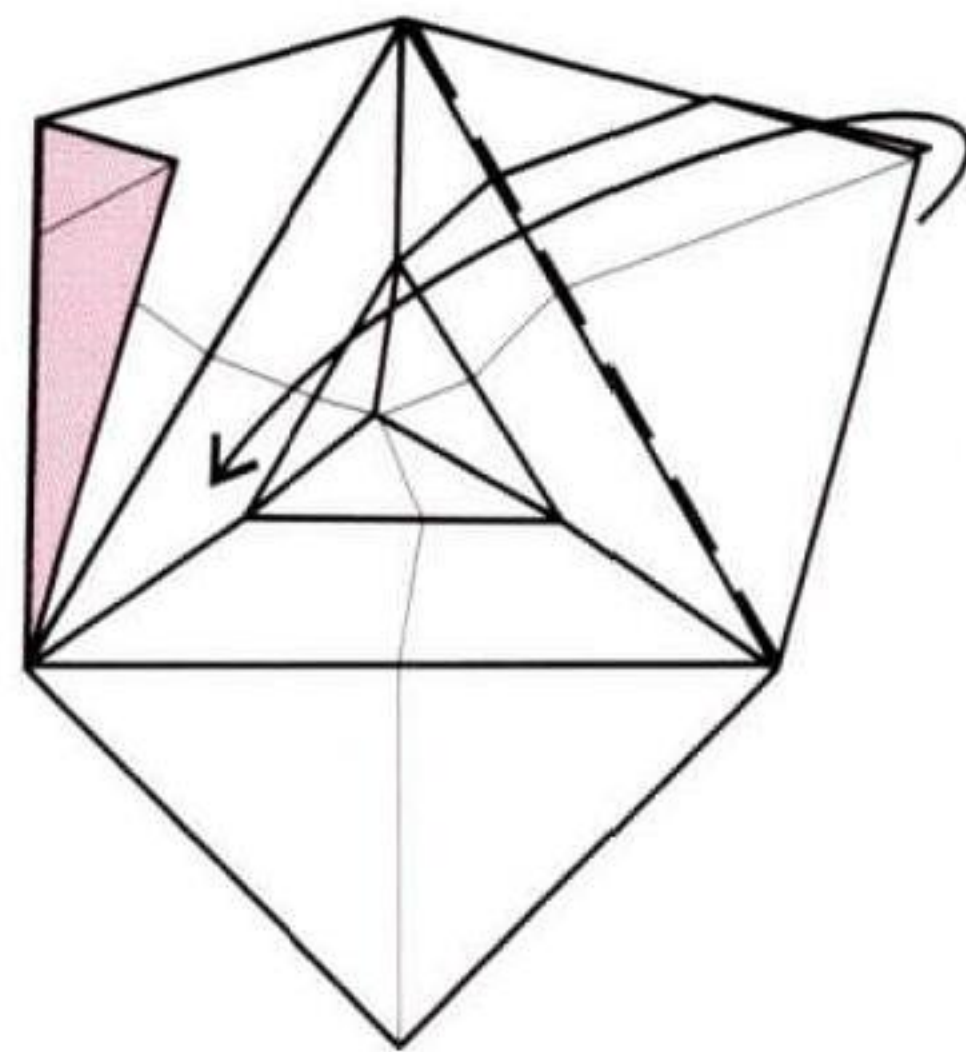

17 This view shows the underside. Fold the outer corner over.

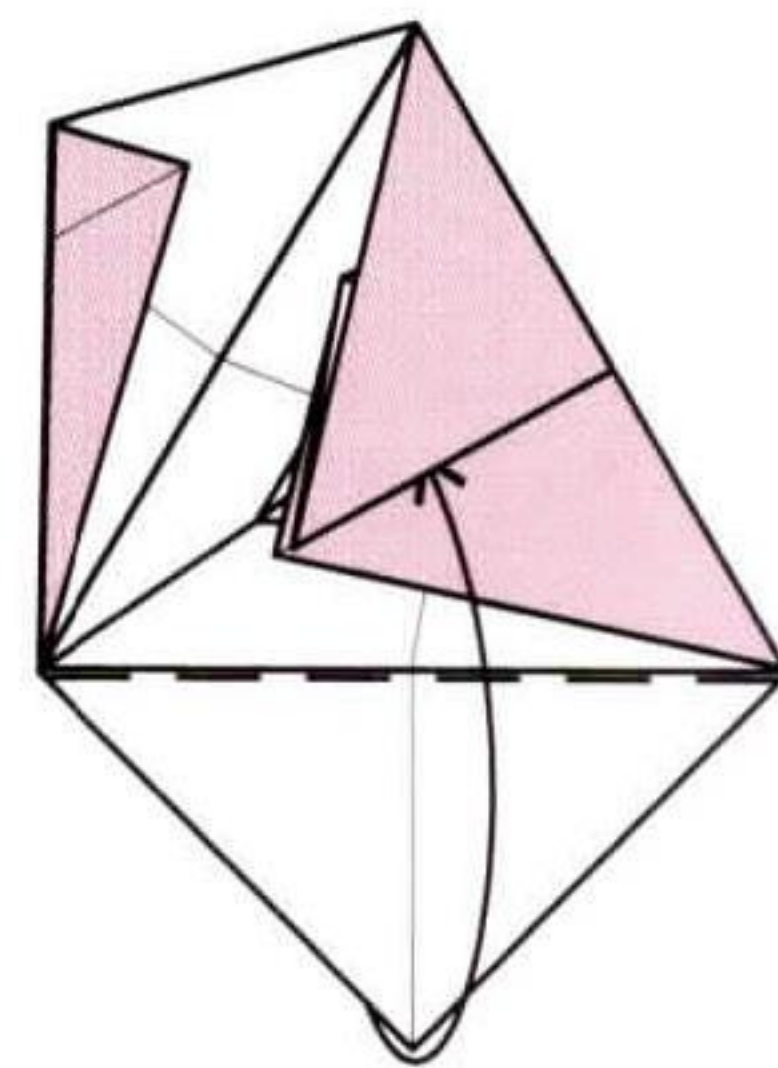

18 Fold the second side up and tuck it under the folded edge.

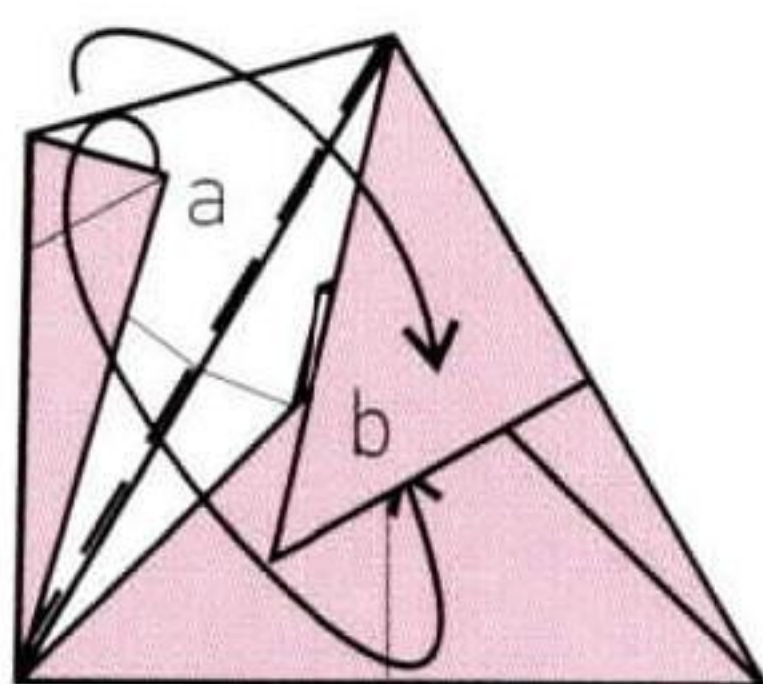

19 Fold the final side over and tuck the folded flap (a) beneath the folded edge (b).

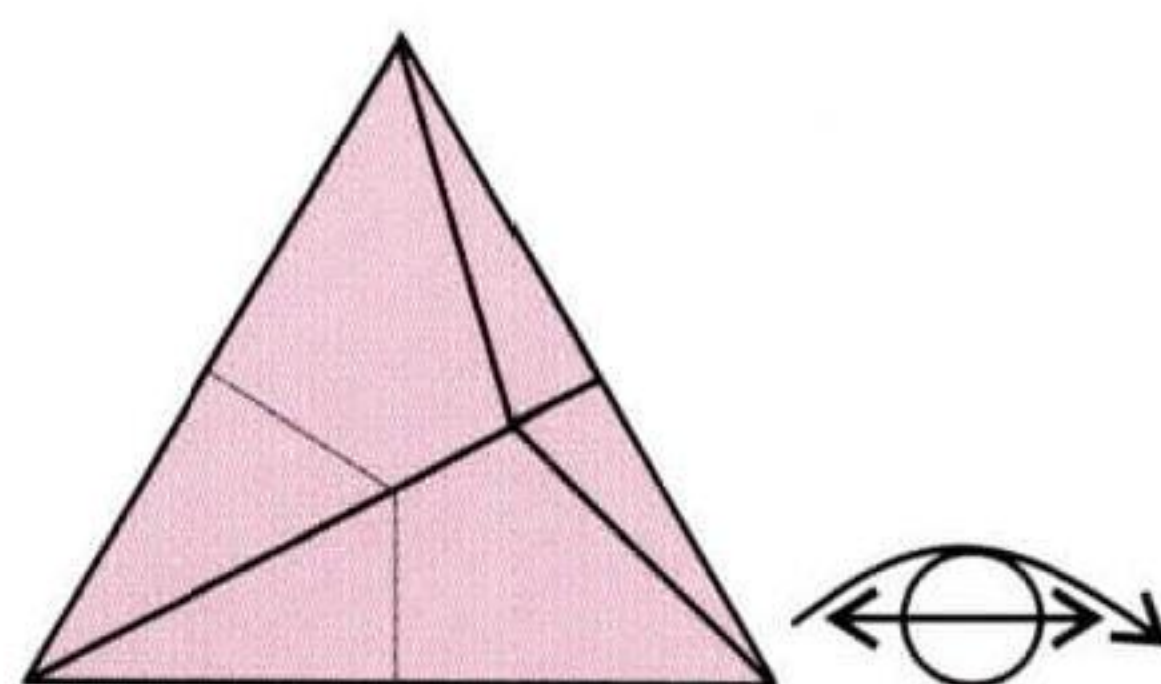

20 The edges should hold together as a result of the tension from the folded section beneath. Turn the model over.

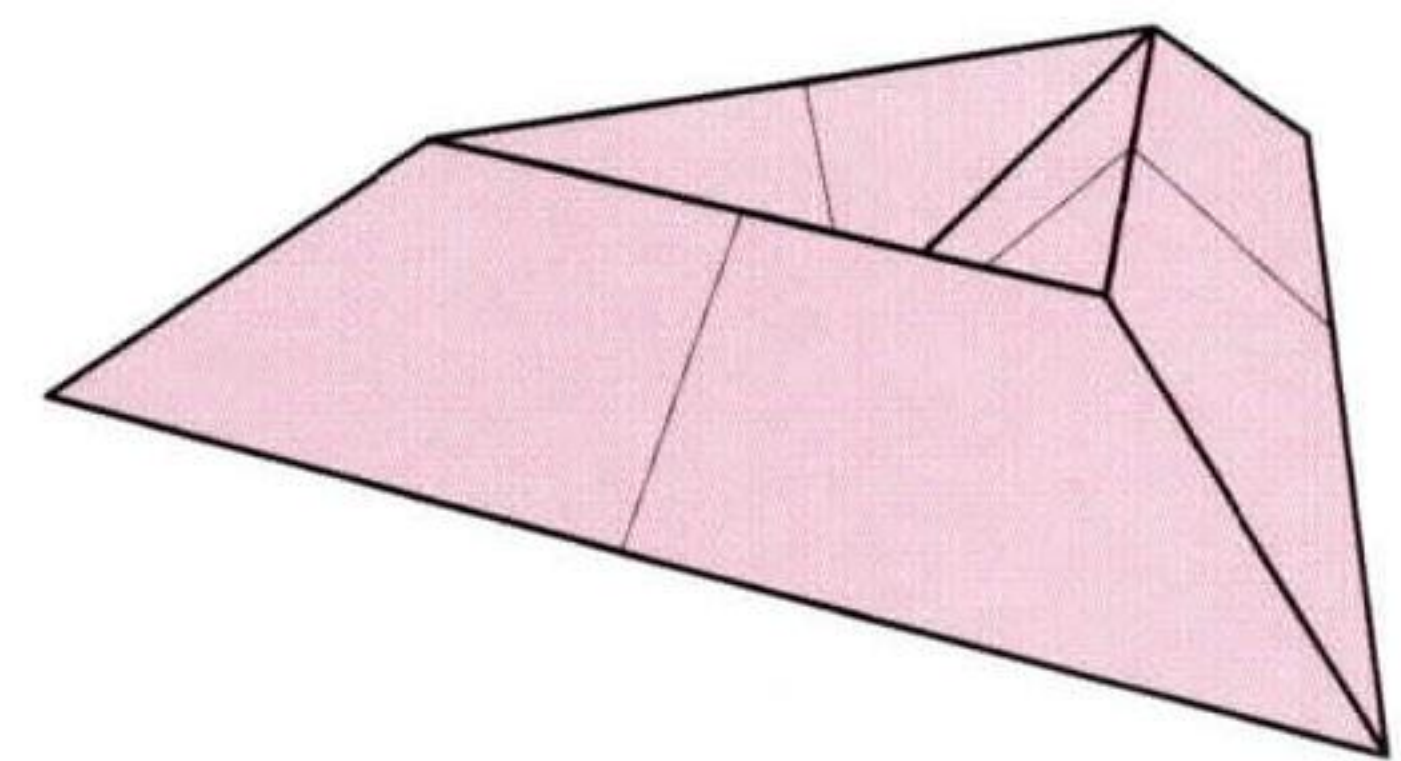

21 Complete.



Diamond



The diamond is constructed from radial folds emanating from the middle of a square. This forms the narrower end, with the edges of the square folding in on themselves to form the face.

18 X 18CM (7 X 7IN)

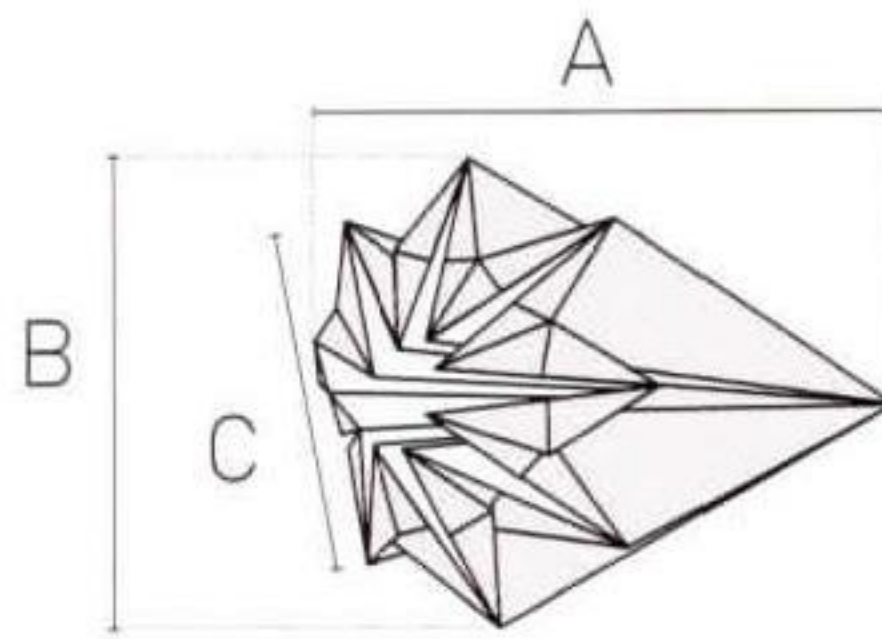
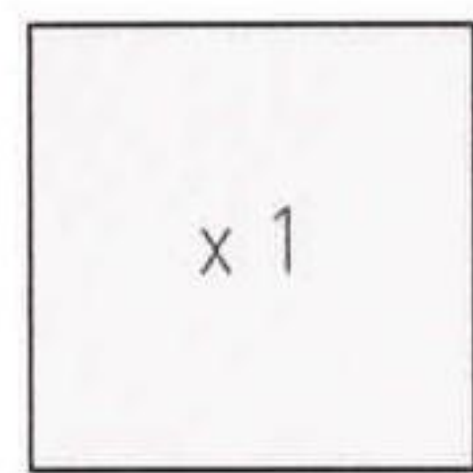

A	7.2cm	[2 ³ / ₄ in]
B	4.7cm	[1 ³ / ₄ in]
C	4.7cm	[1 ³ / ₄ in]

START WITH A SQUARE, COLOURED SIDE UP.

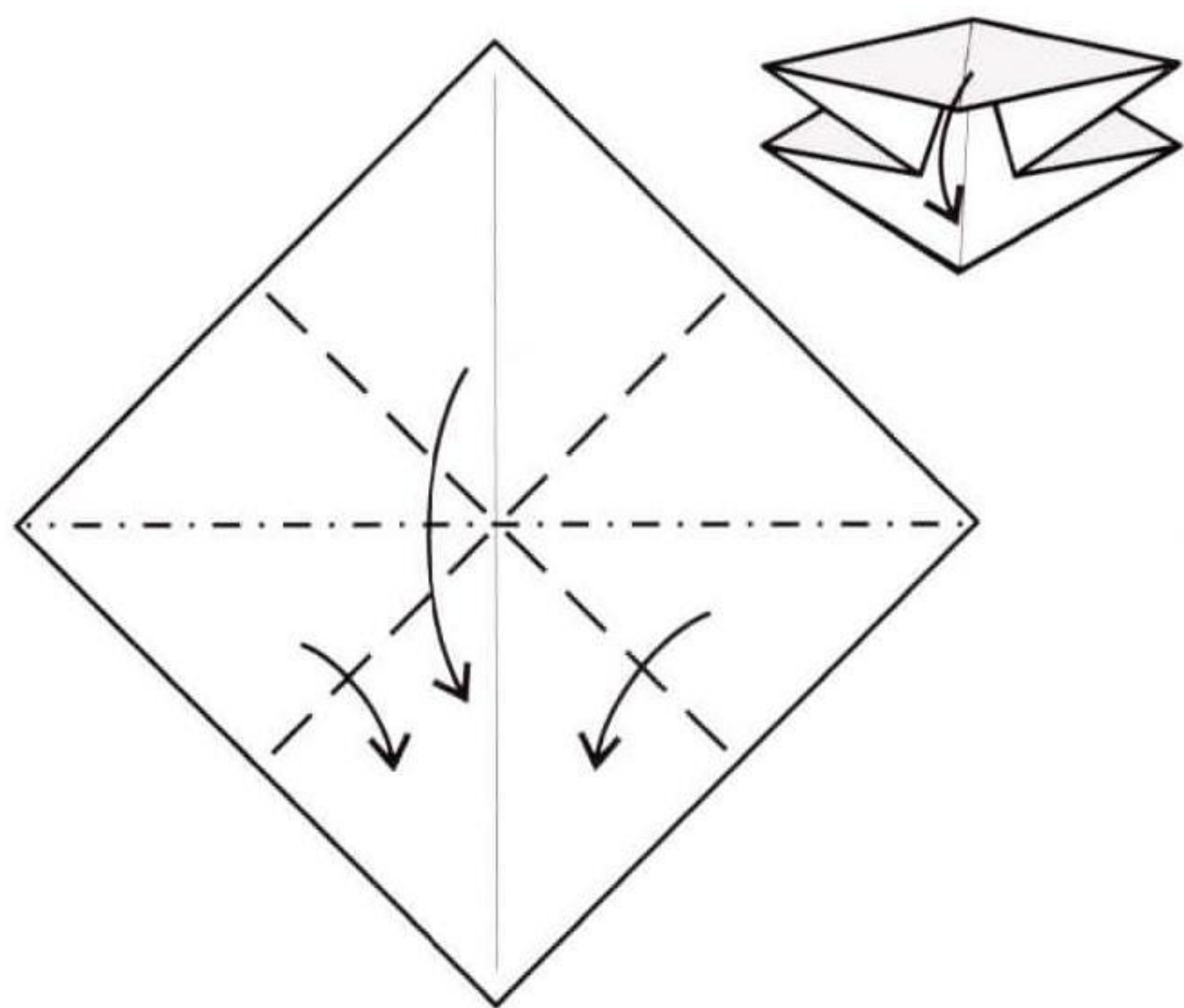

- 1 Fold the upper corner down to touch the opposite corner. At the same time fold in the sides to make a preliminary base for the model.

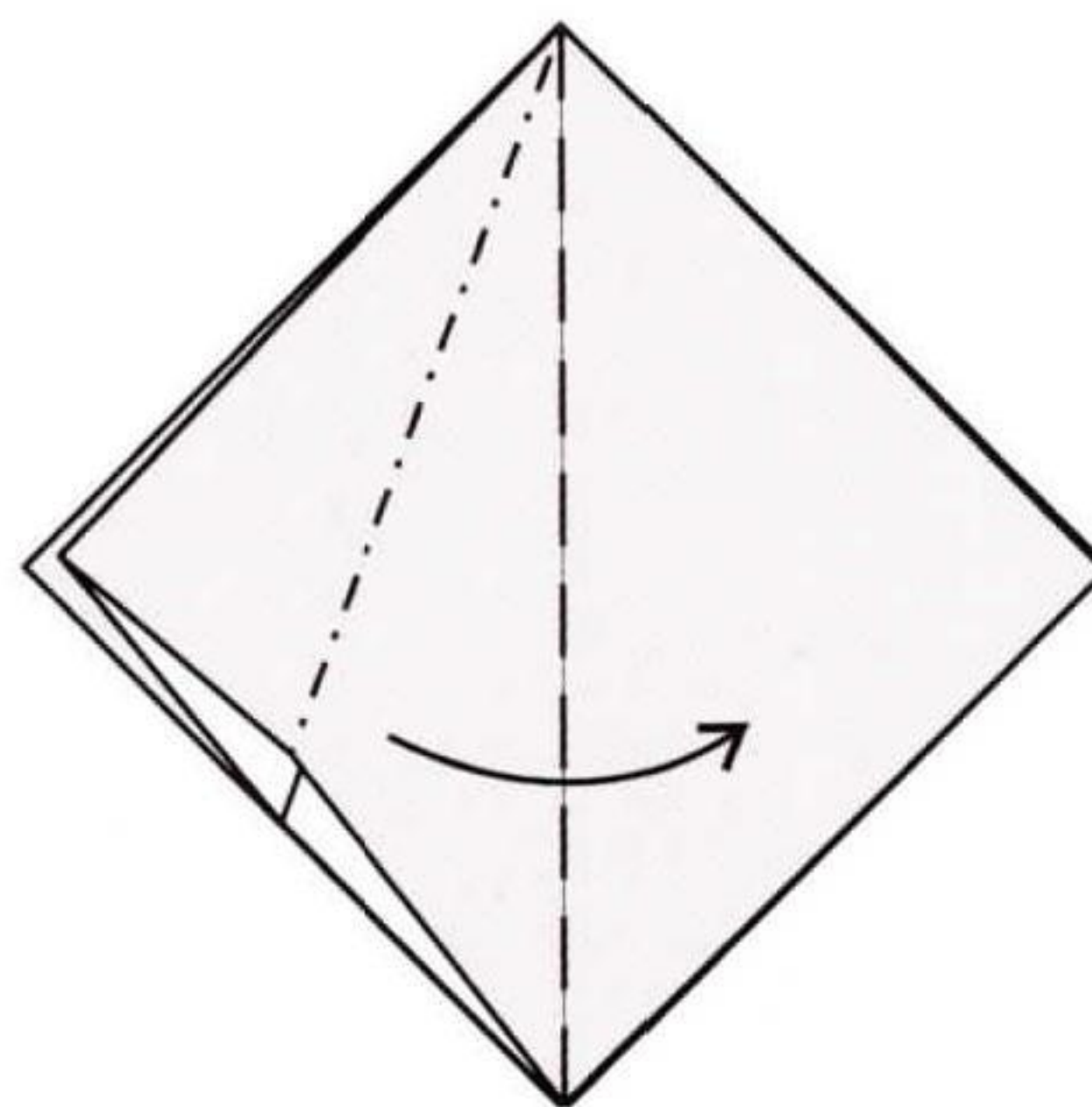

- 2 Fold the left corner up, separate the layers and squash flat.

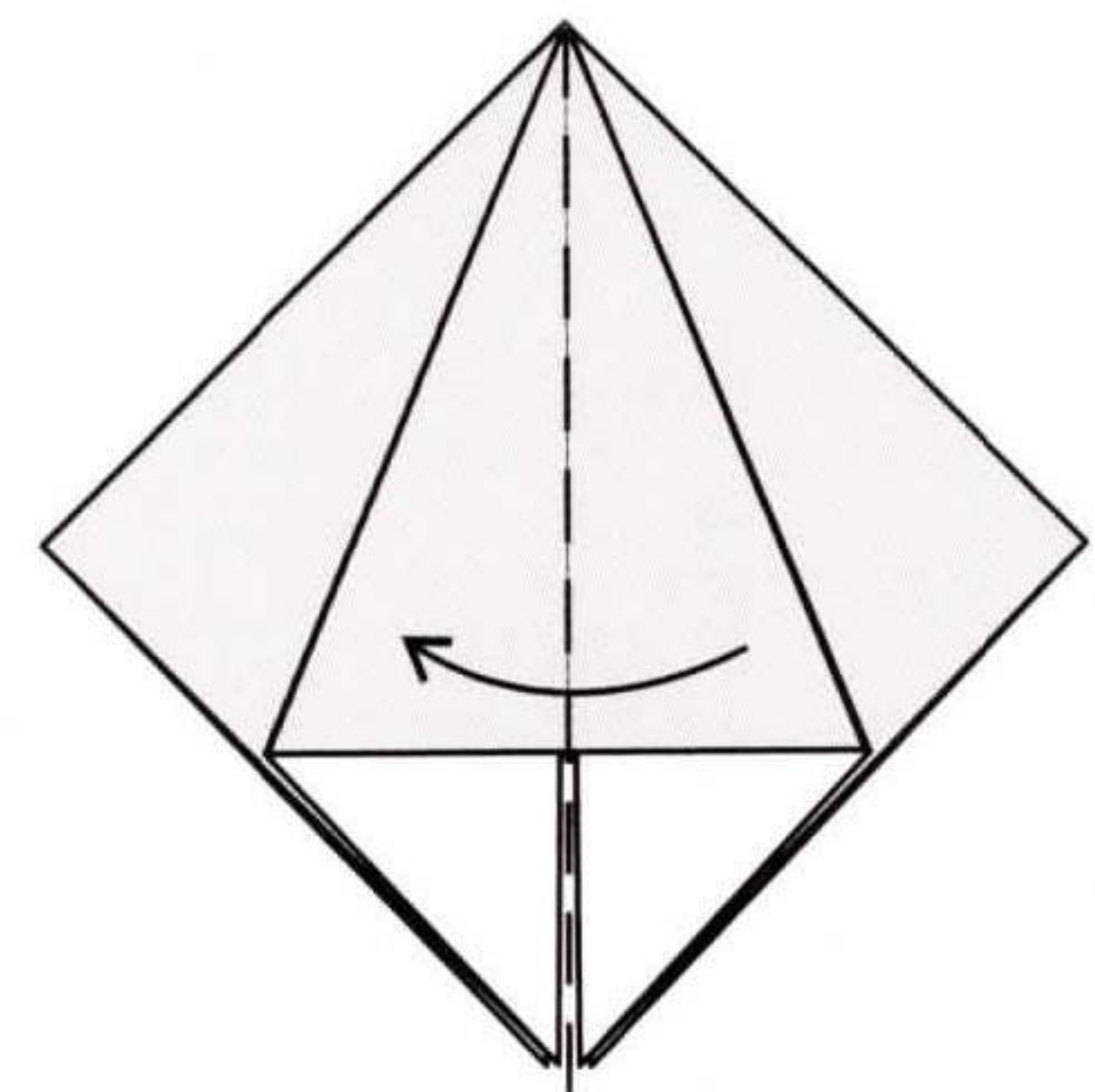

- 3 Fold the right side back to the left.

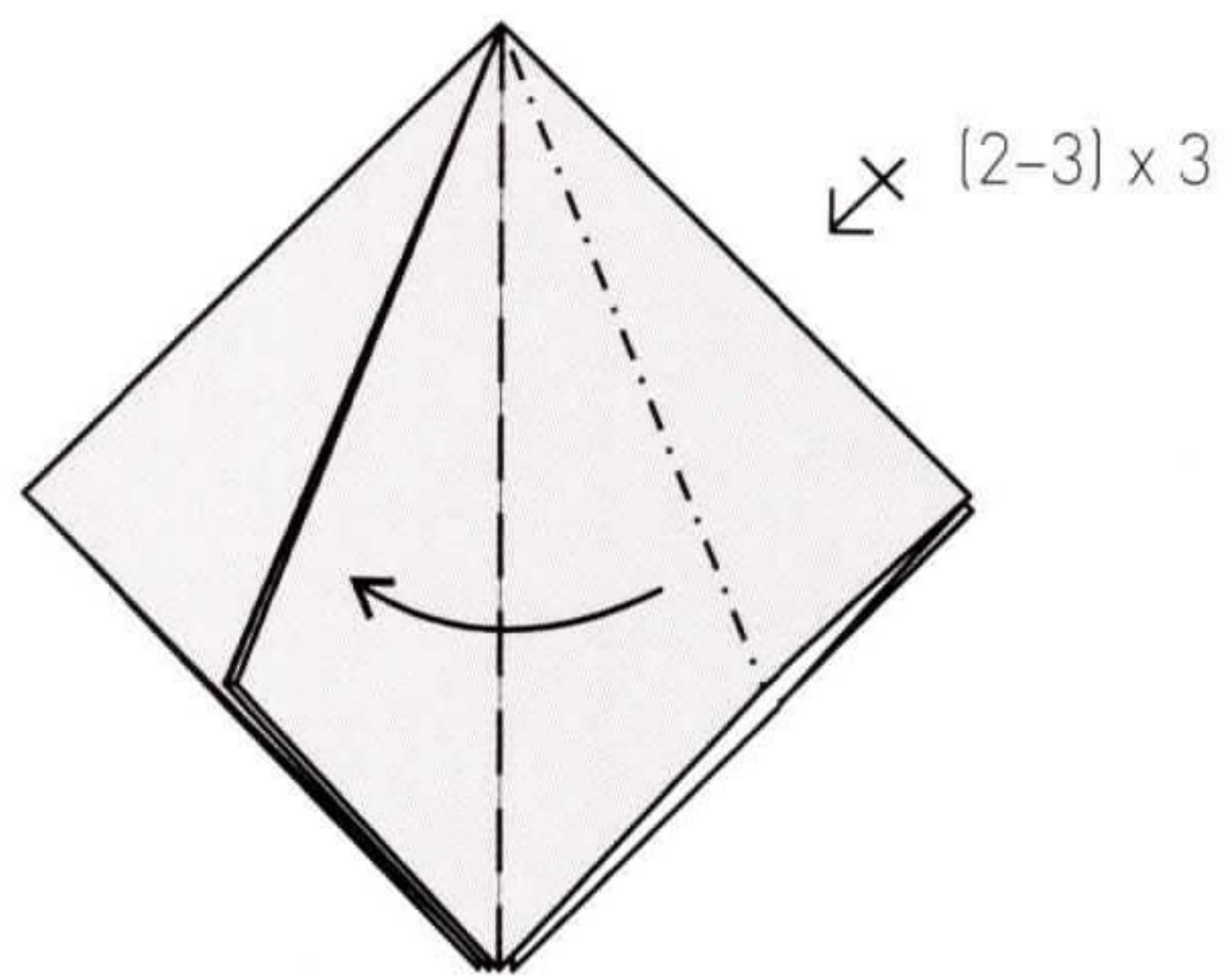

4 Repeat the squash process on the other three corners.

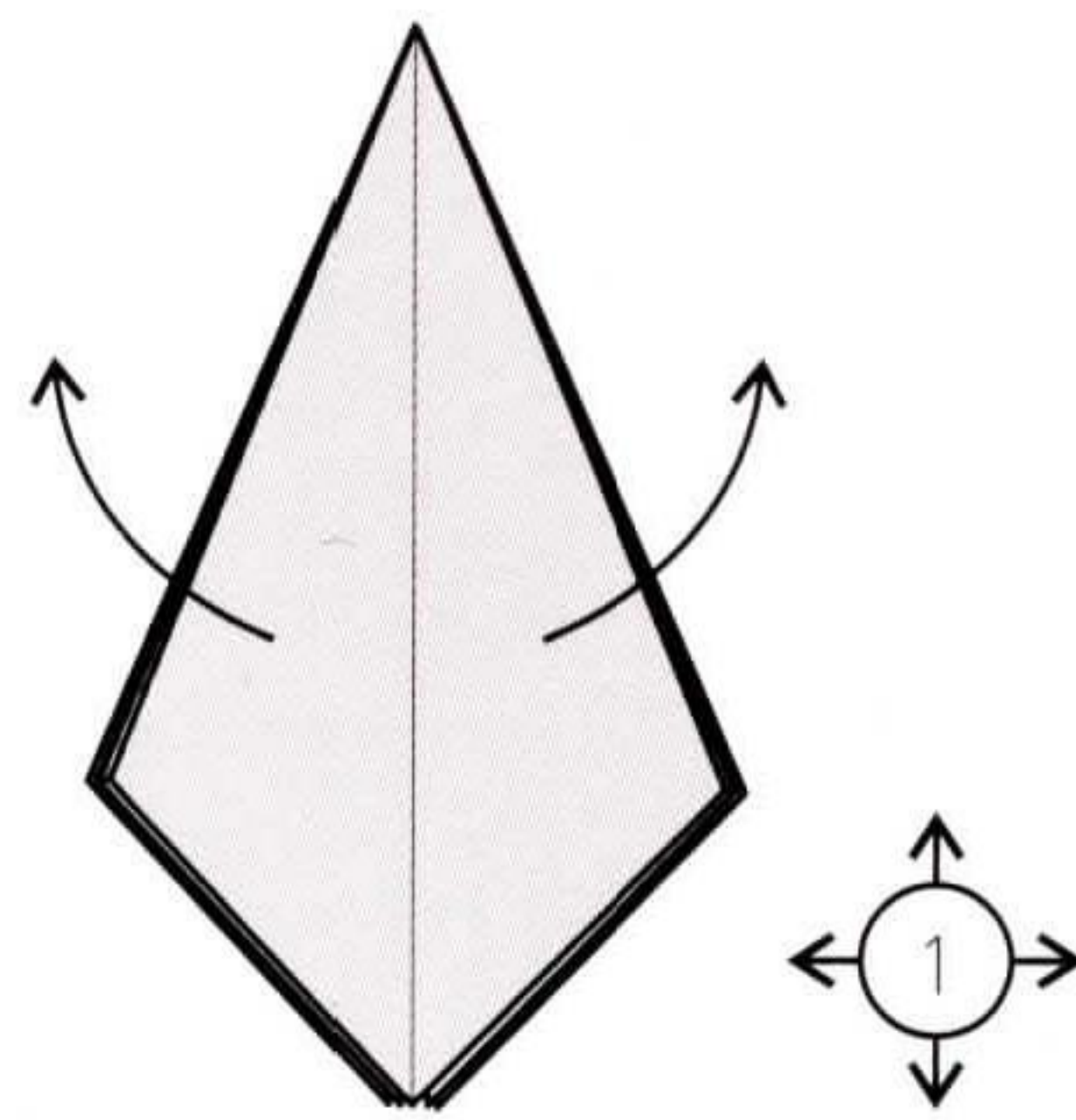

5 Open out the paper back to a square (step 1).

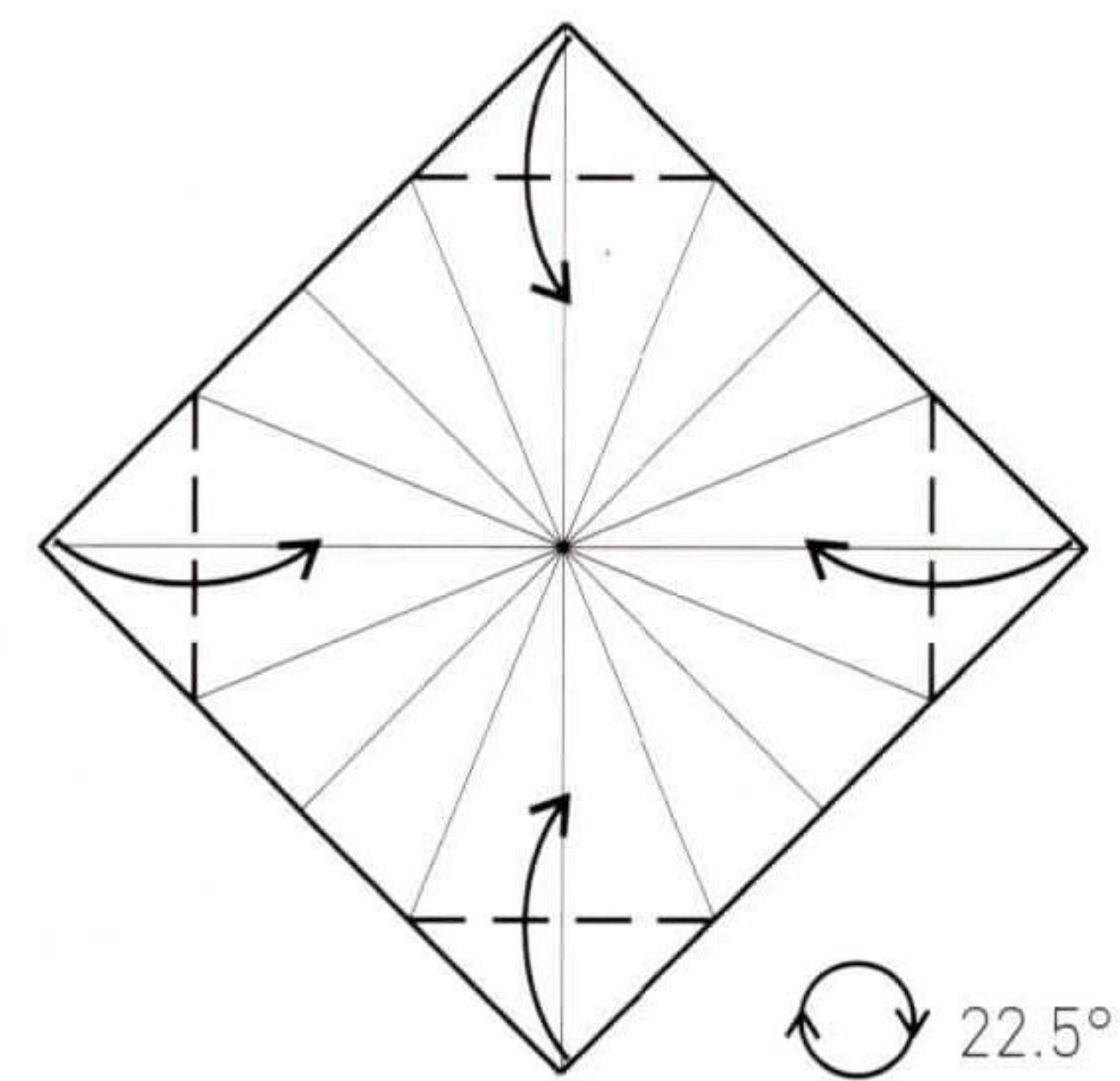

6 Fold the four outer corners in between the creases made previously. This will make an octagon. Then rotate the model.

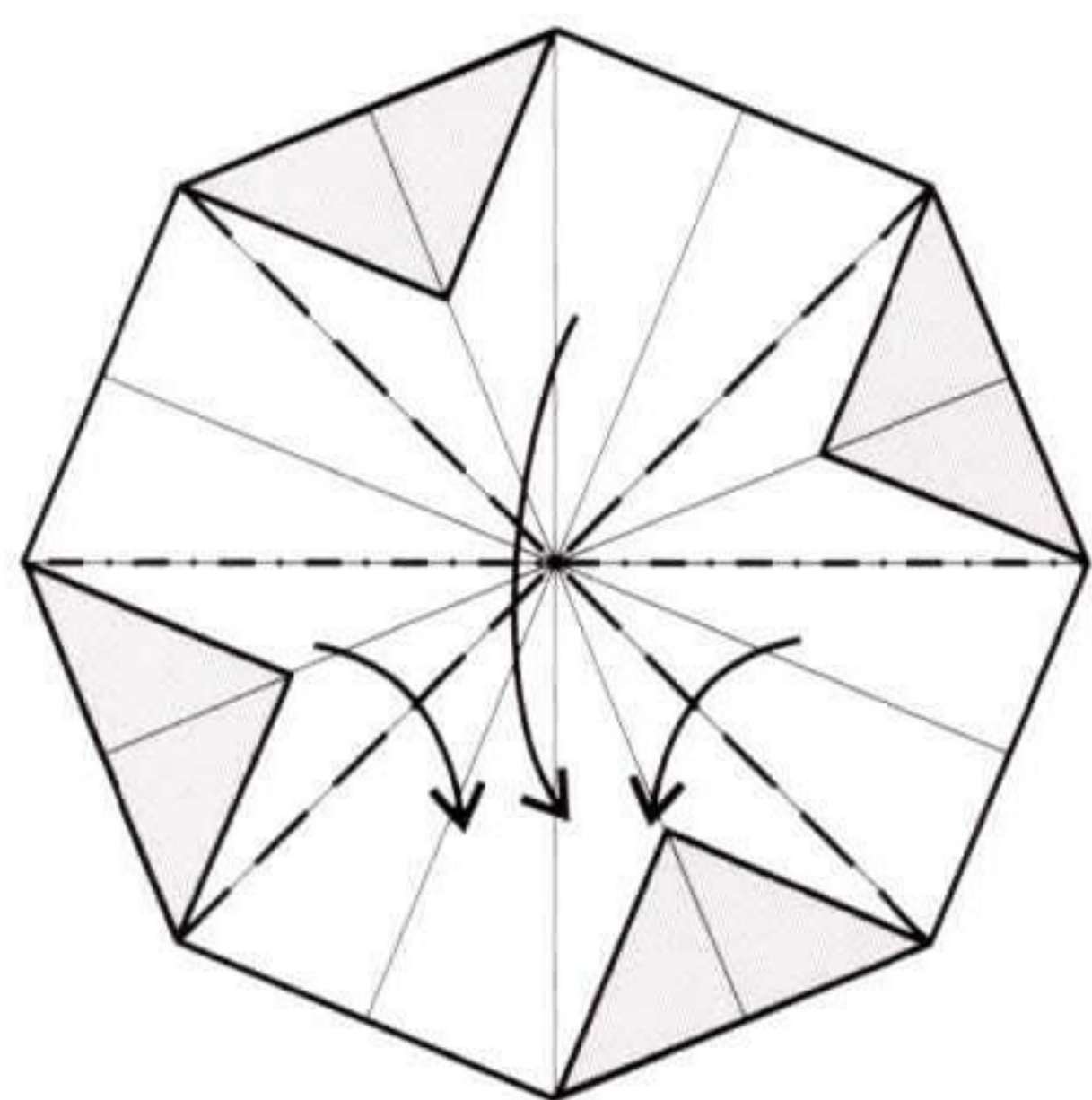

7 Fold the upper section over the lower half, and at the same time fold in the sides.

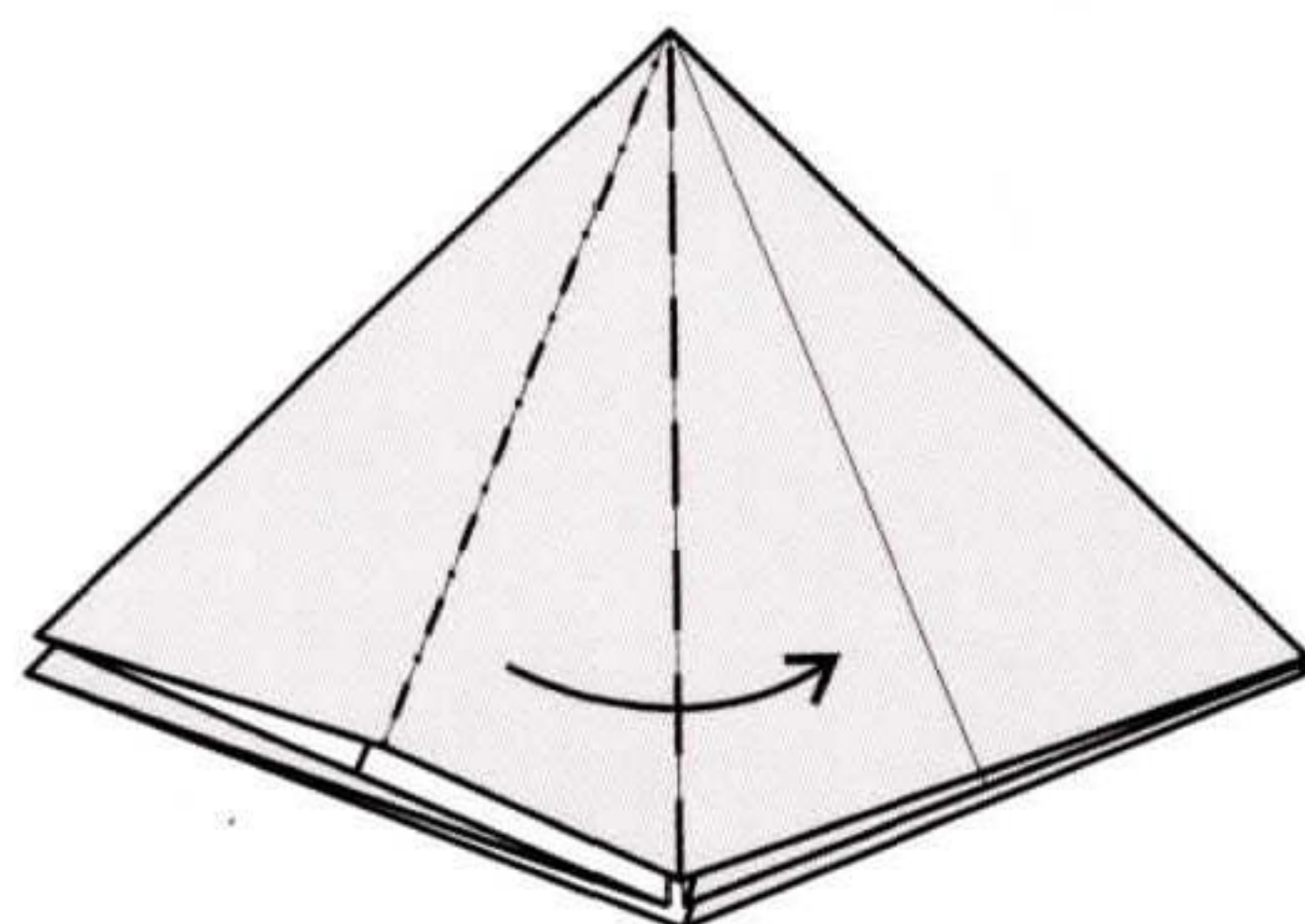

8 Fold the corner up, separate the layers and squash flat.

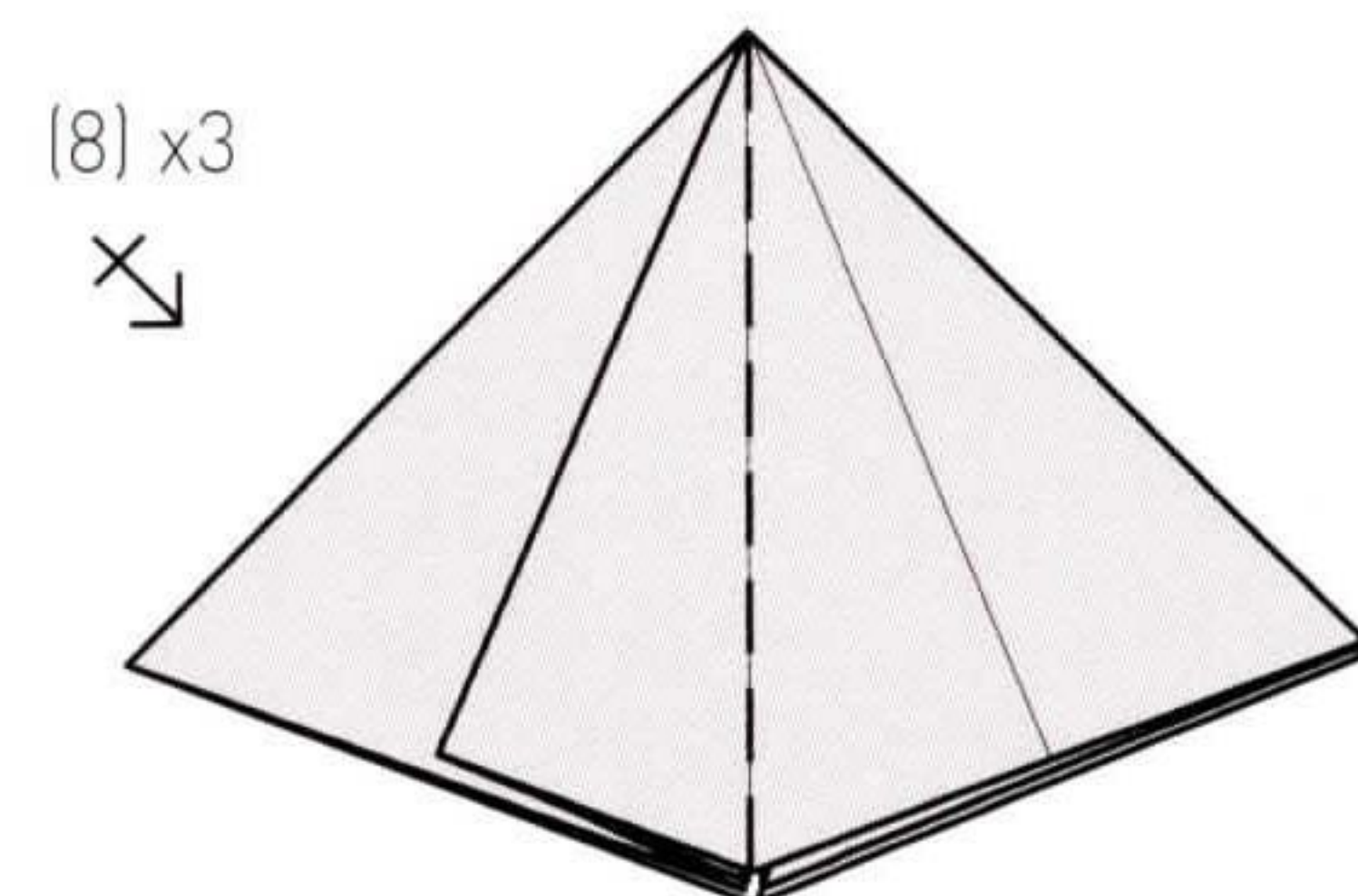

9 Repeat the squashing process on the other three corners.

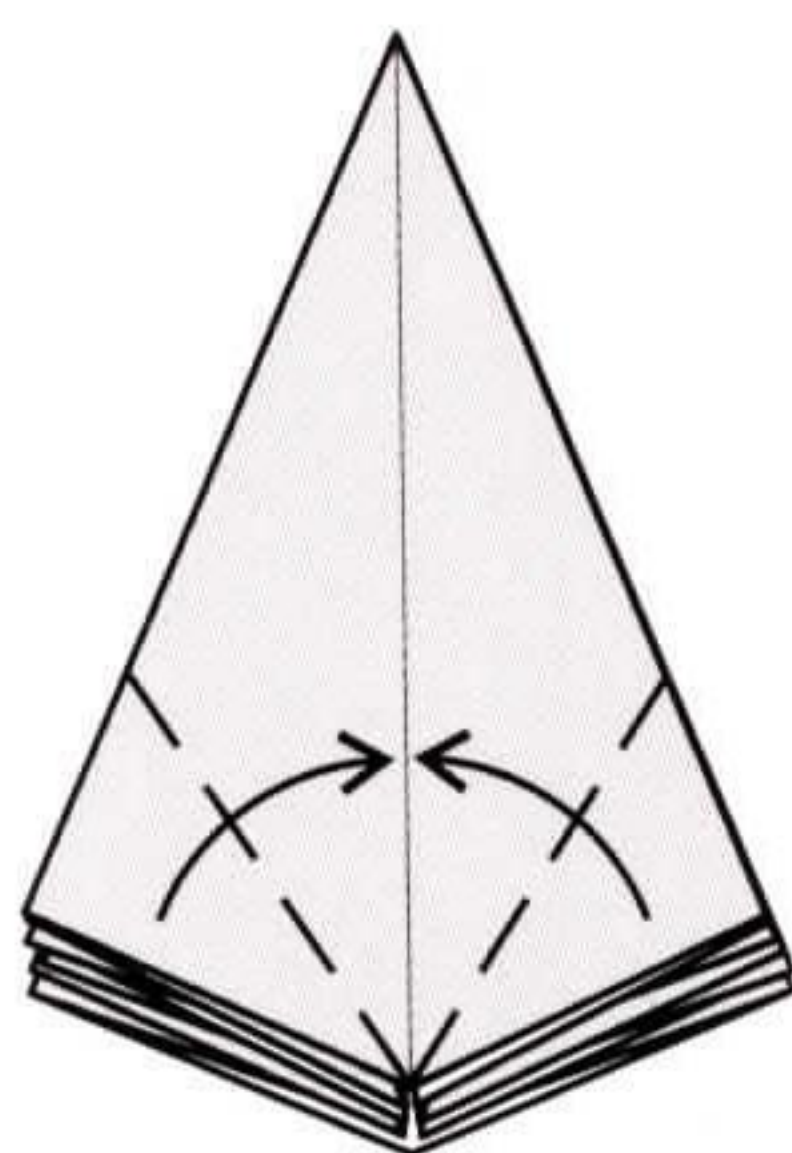

10 Fold the edges in to the middle crease.

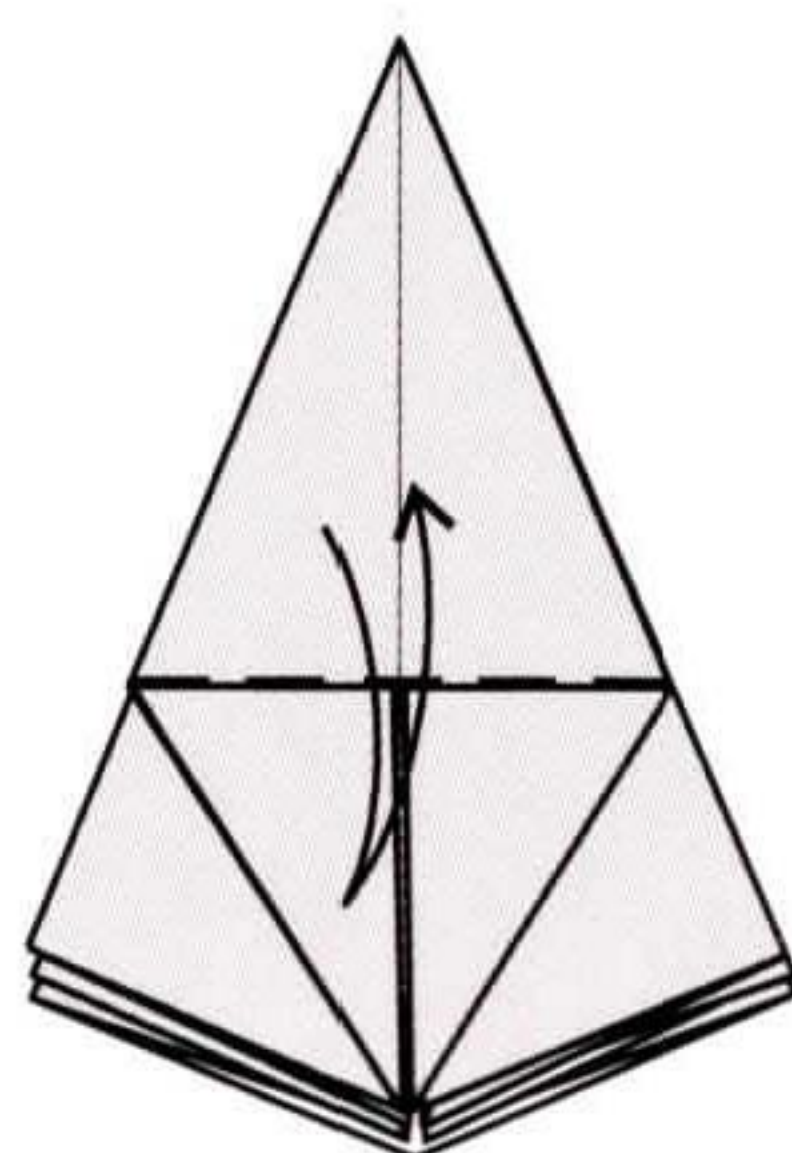

11 Fold and unfold the upper section over the folded edges.

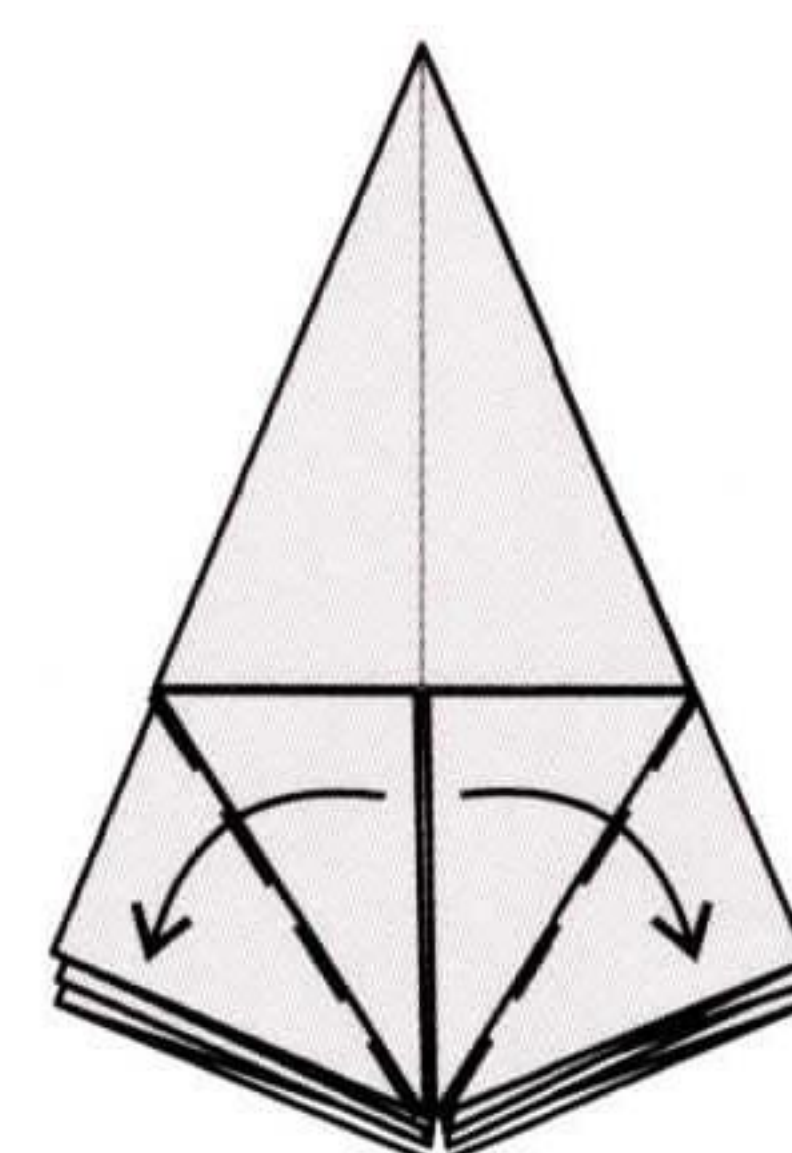

12 Fold the corners back out again.

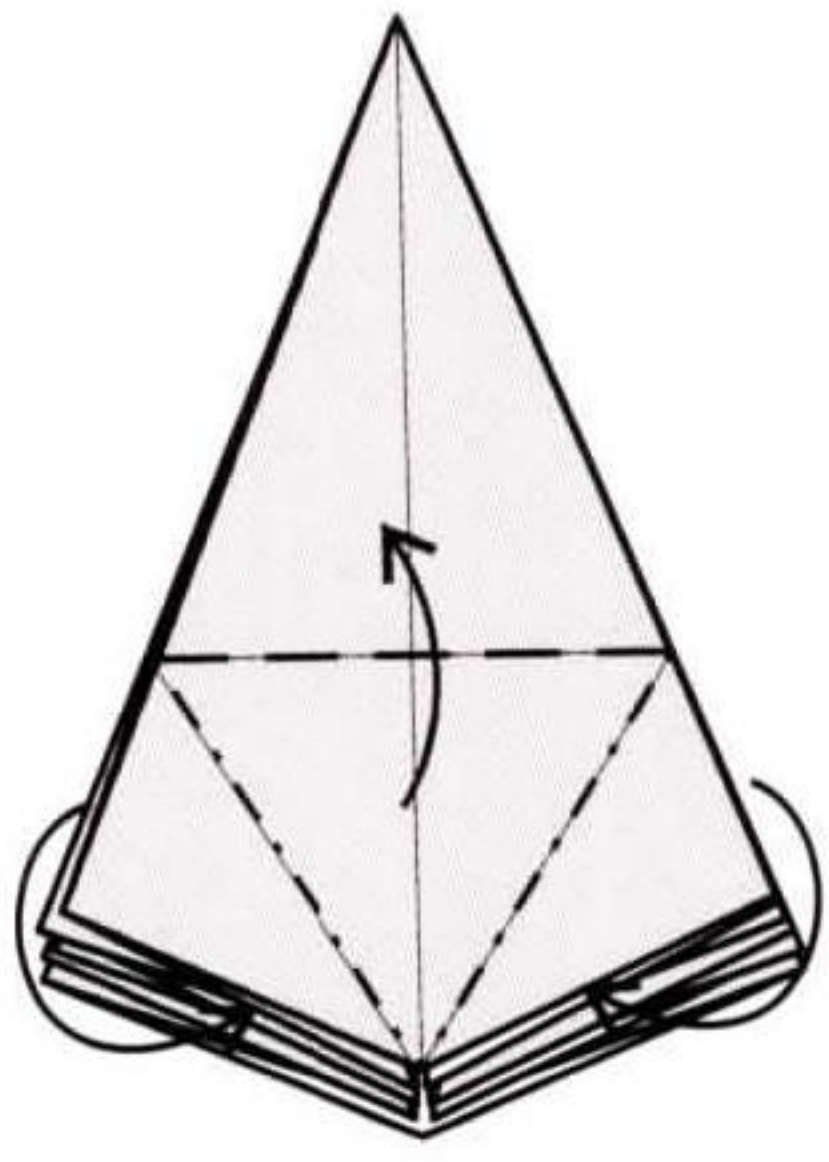

- 13 Fold the upper layer up along the crease made previously. This will cause the outer edges to fold in.

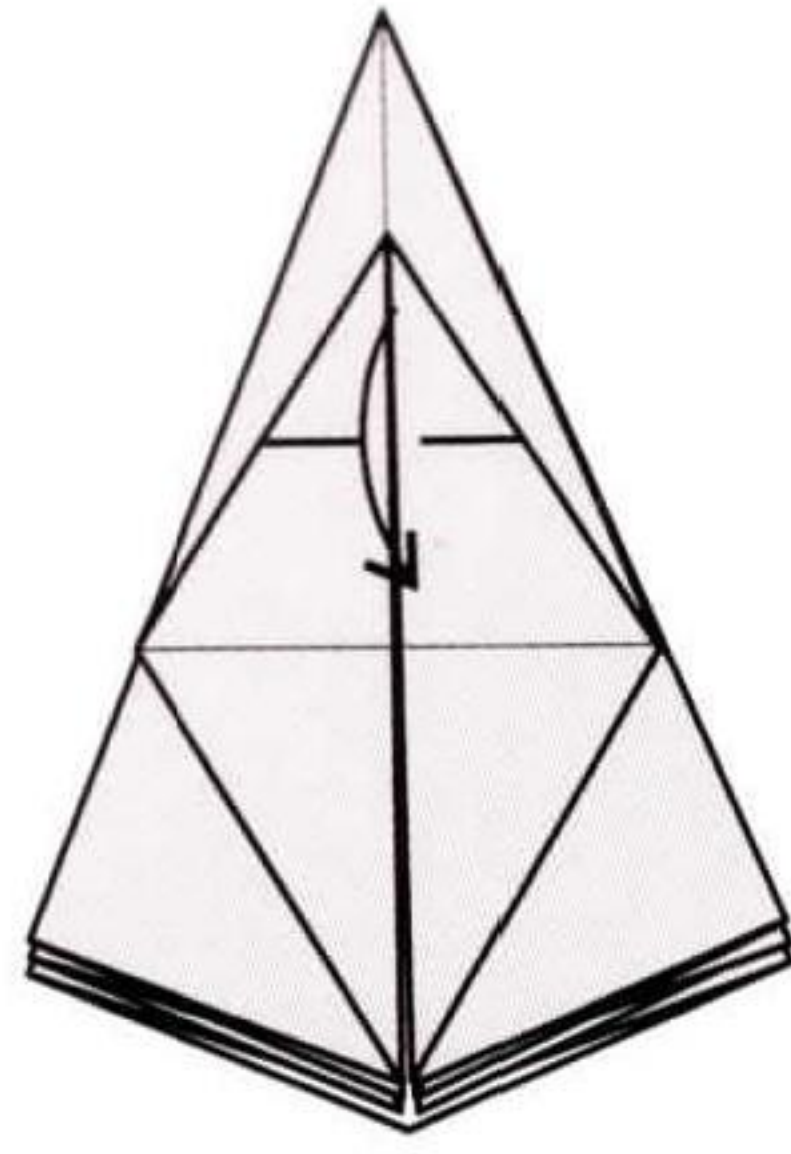

- 14 Fold the tip of the corner down to touch the crease.

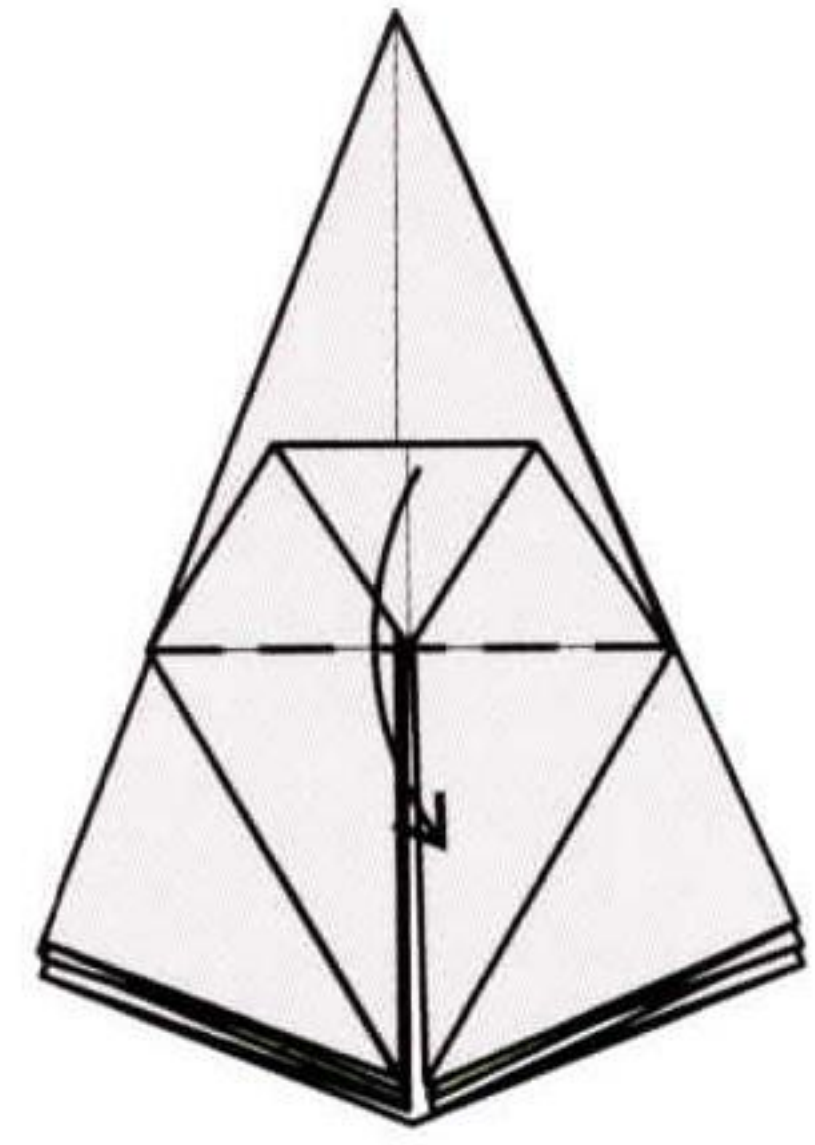

- 15 Fold the section over again.

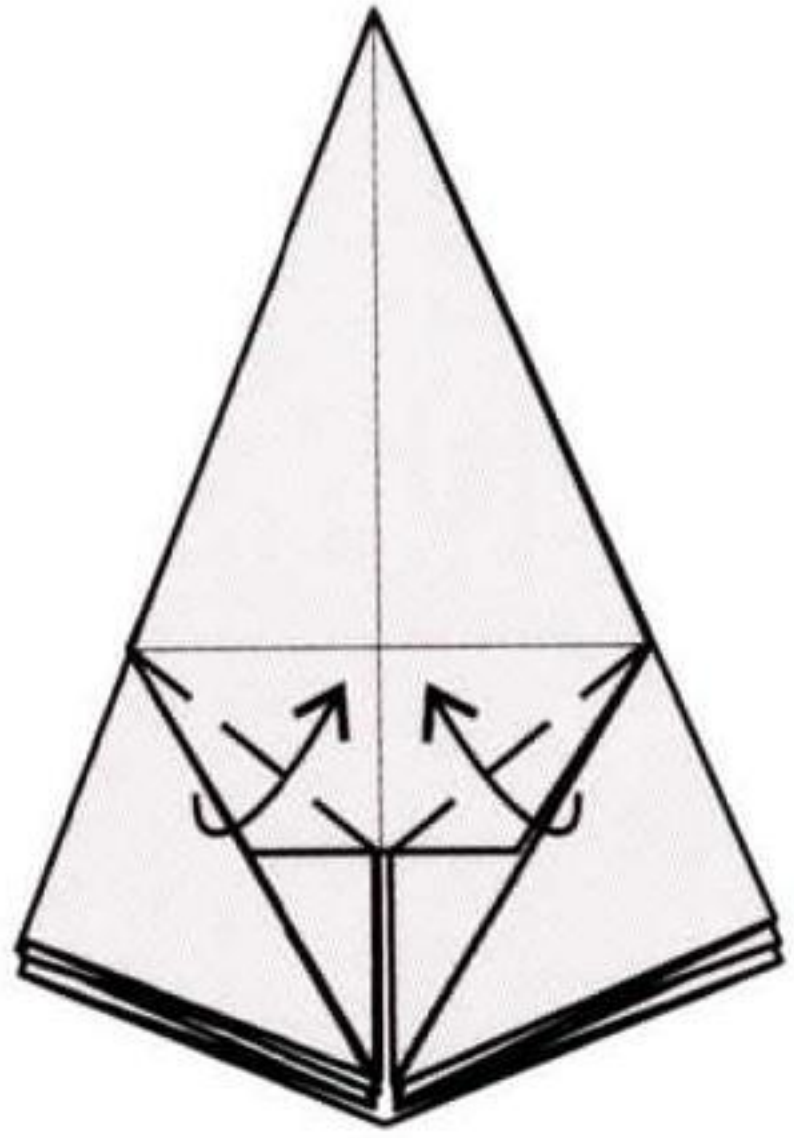

- 16 Fold the corners in on both sides.

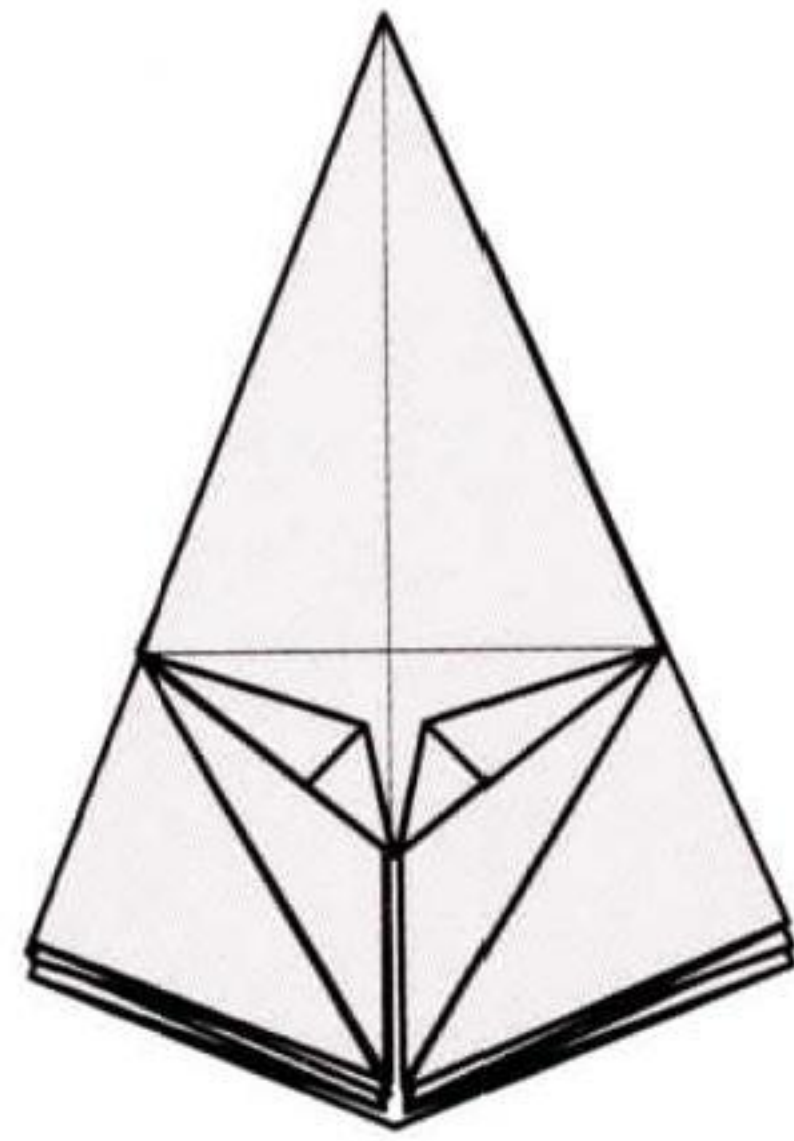

- 17 Repeat steps 10 to 16 on the other faces.

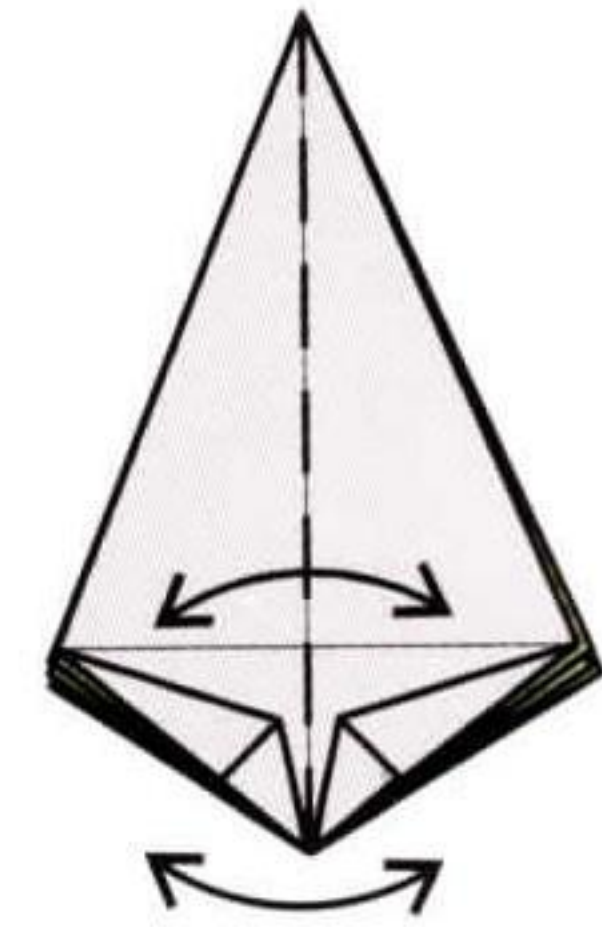

- 18 Open the model and even out the layers.

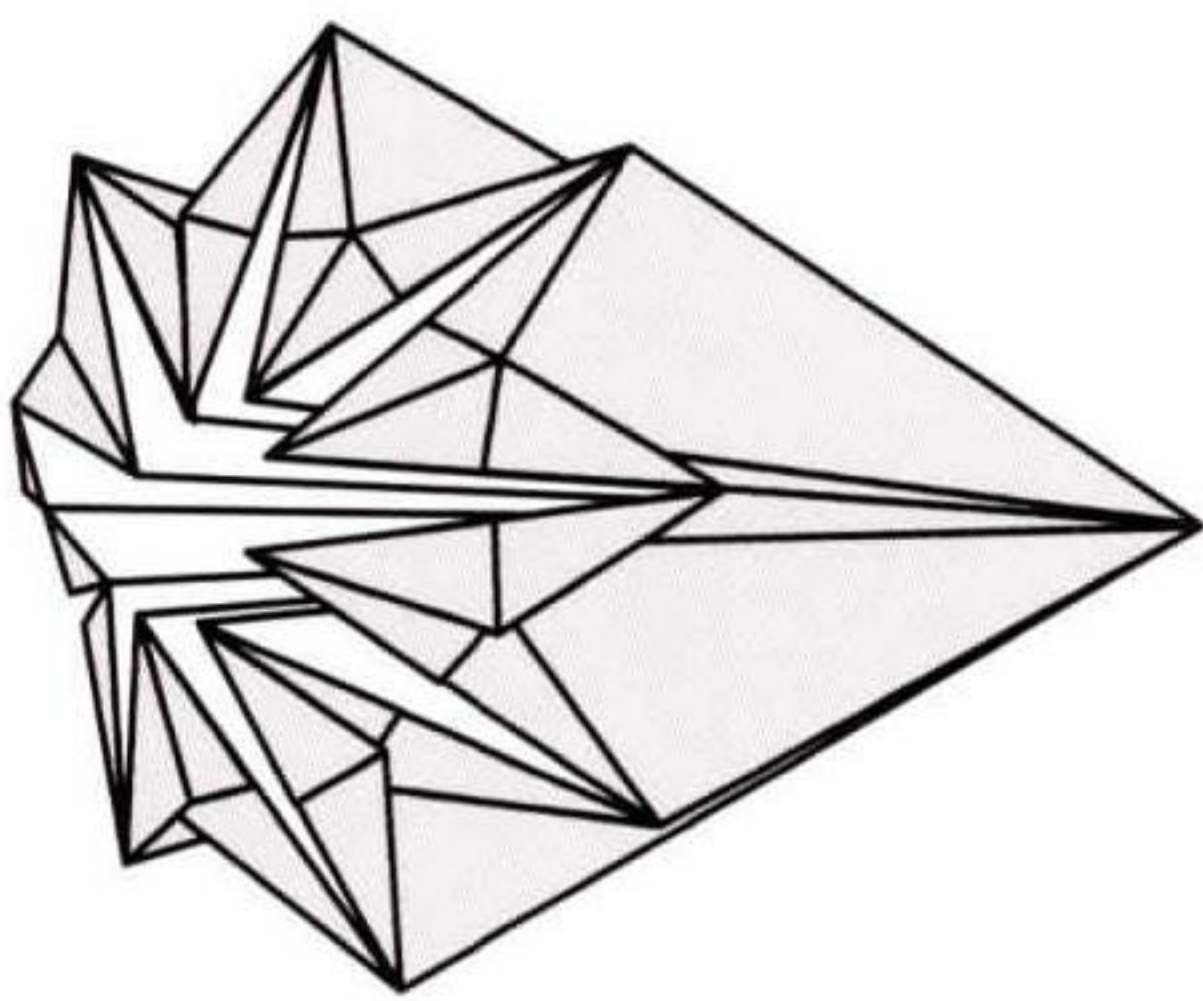

- 19 Complete.

Geo Ball

**

The geo ball works by building a curved geometric texture that allows the model to wrap around on itself. The ball is completed by tucking one end into the other. Once the ball is assembled it can be squashed gently by applying pressure at either end.

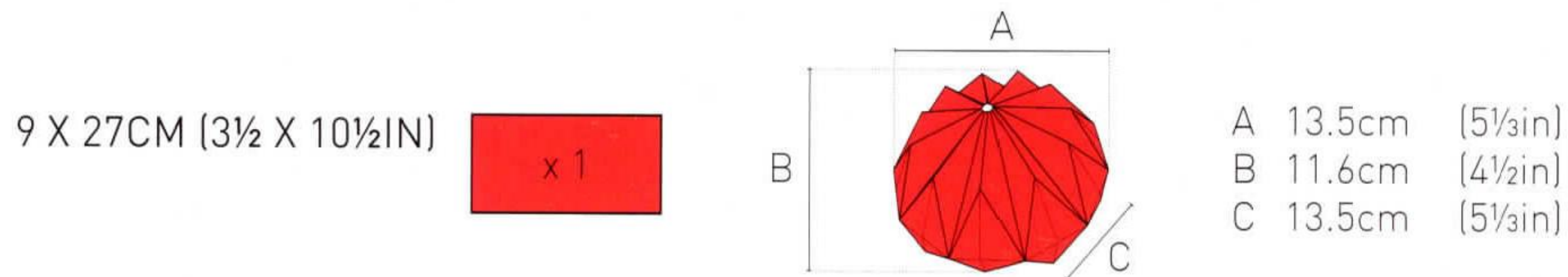

START WITH A 3 X 1 RECTANGLE, COLOURED SIDE DOWN.

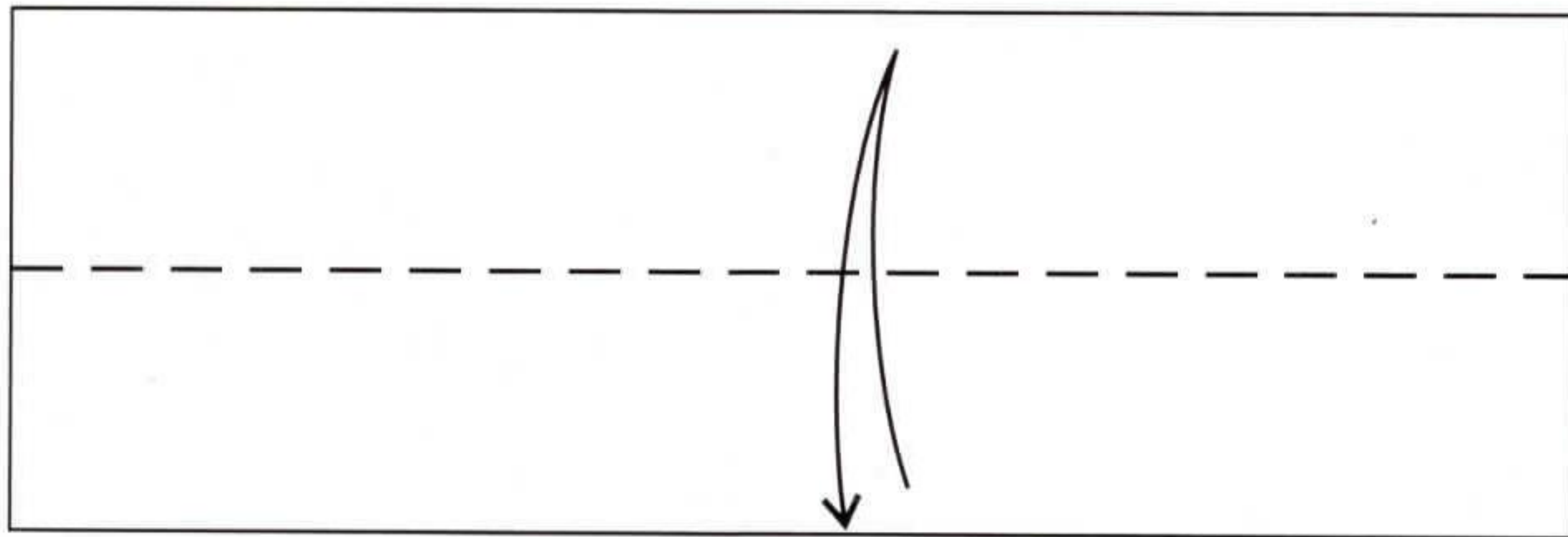

1 Fold and unfold the rectangle in half lengthwise.

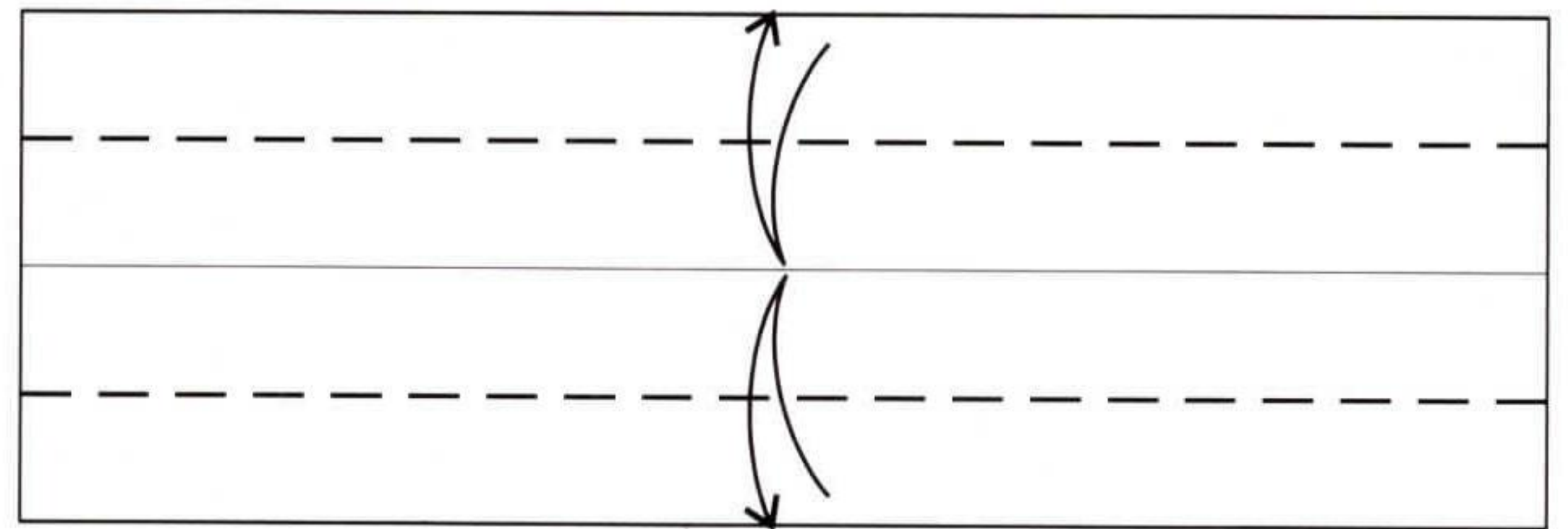

2 Fold the edges in to the middle crease and unfold.

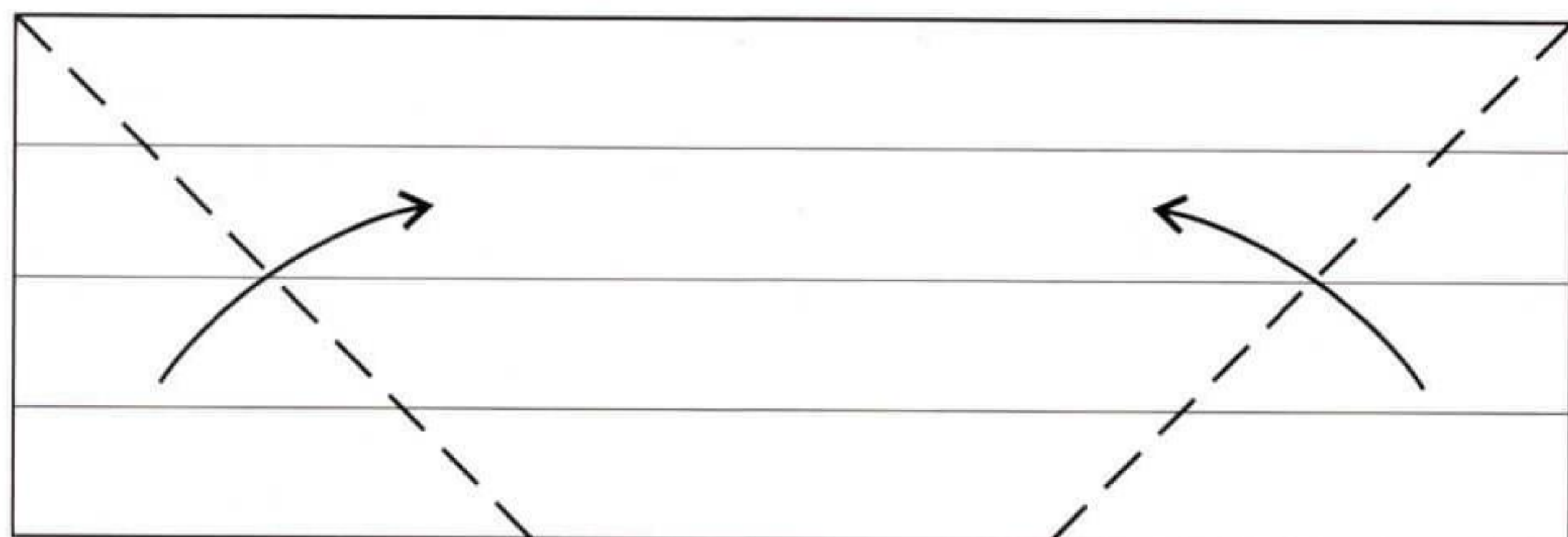

3 Fold the lower corners in so that the outer edges touch the upper edge of the rectangle.

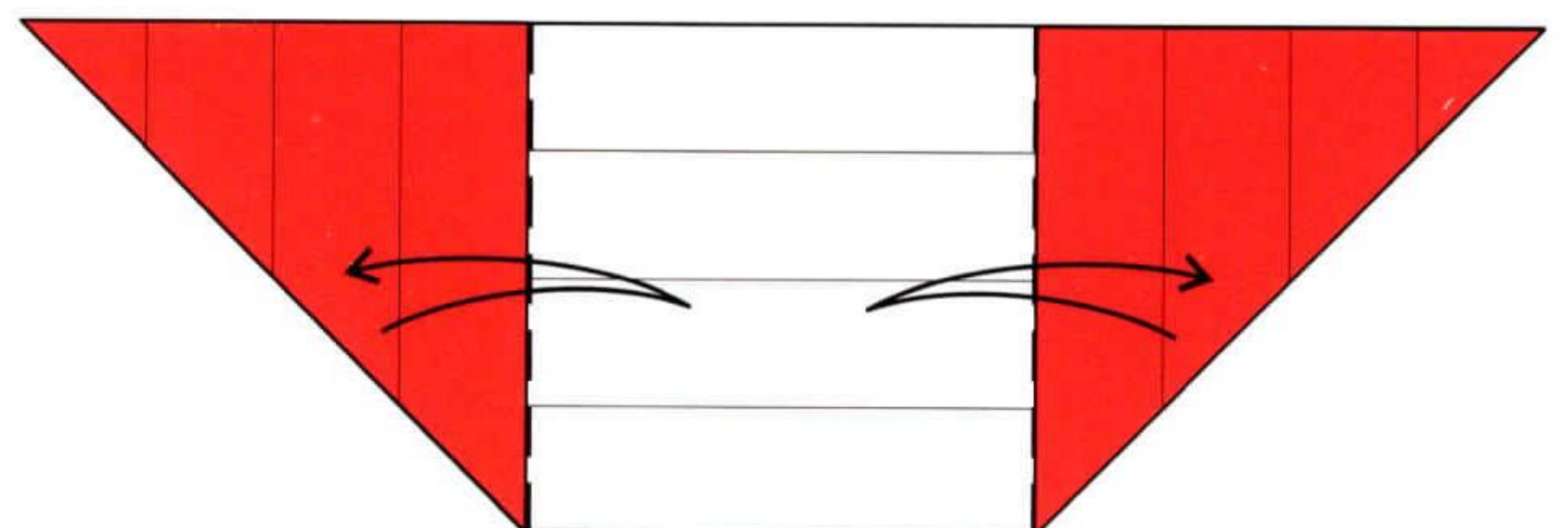

4 Fold the outer sides in along the edges of the folded triangles. Then unfold.

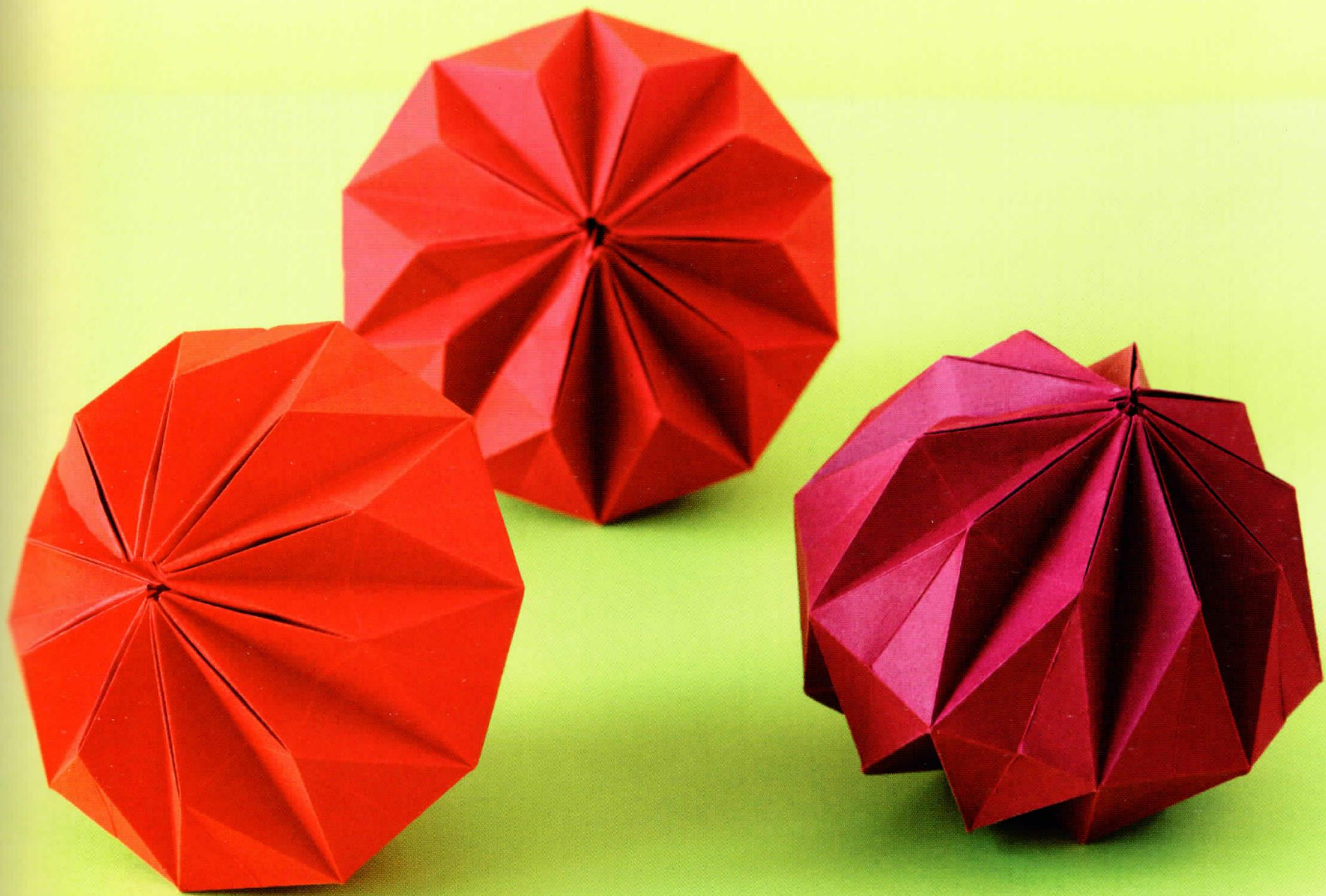

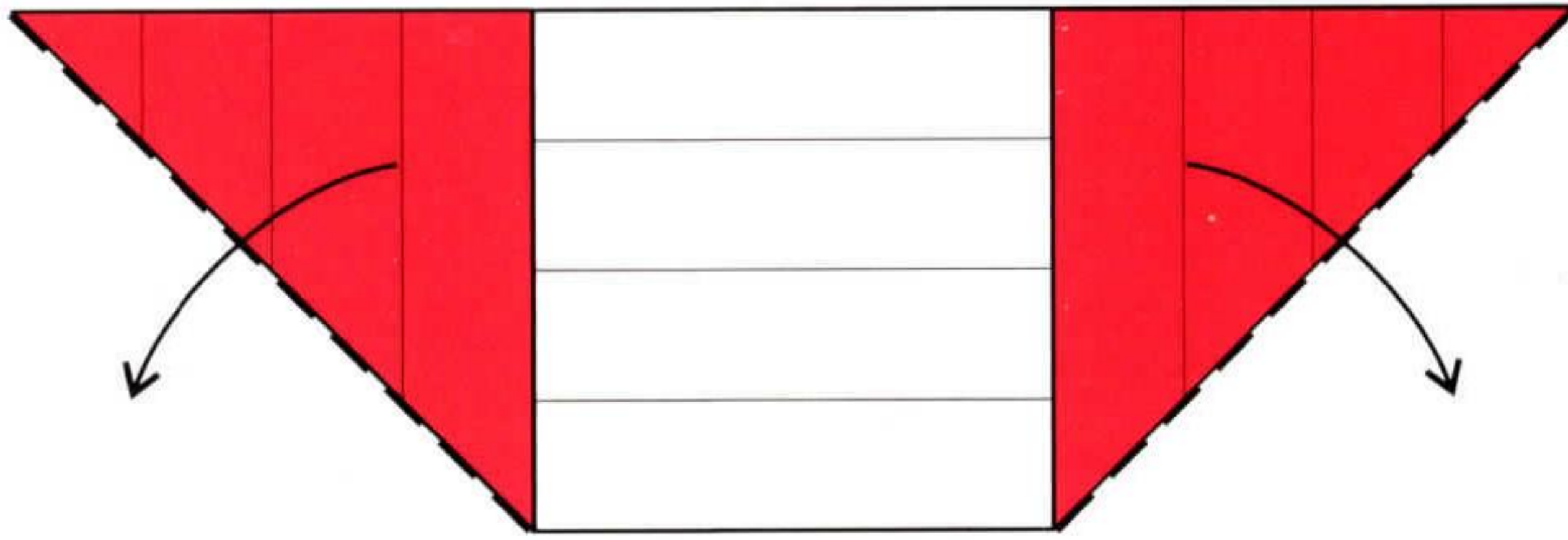

5 Unfold the triangles.

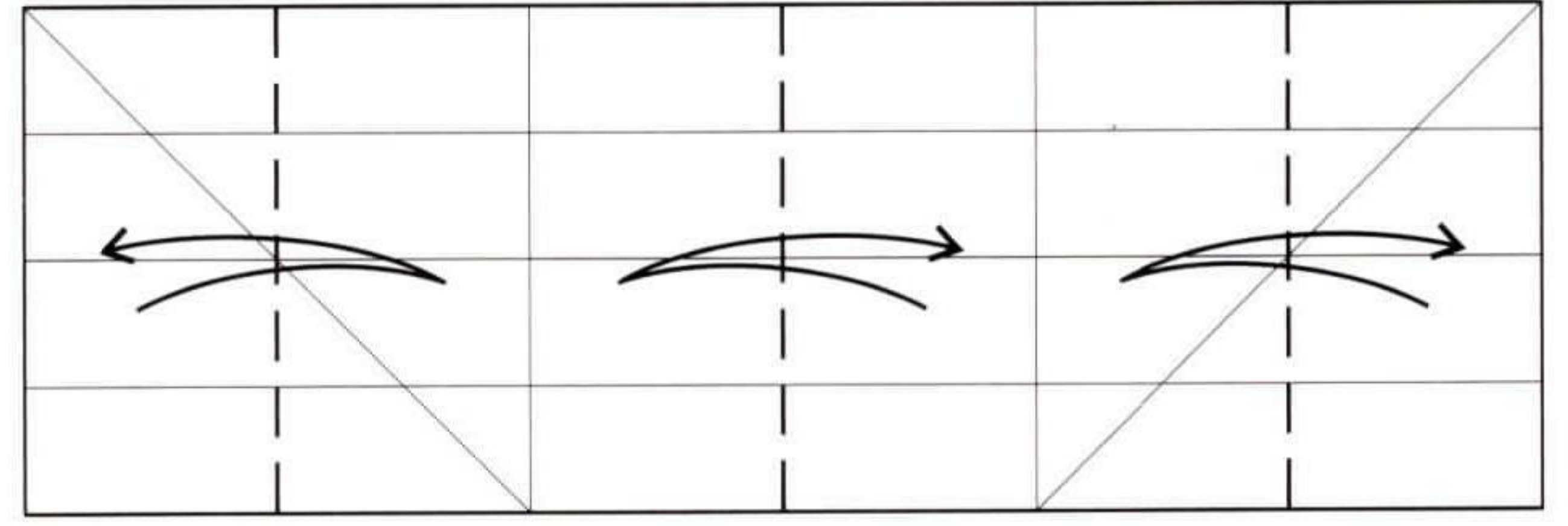

6 Fold and unfold between the creases made previously.

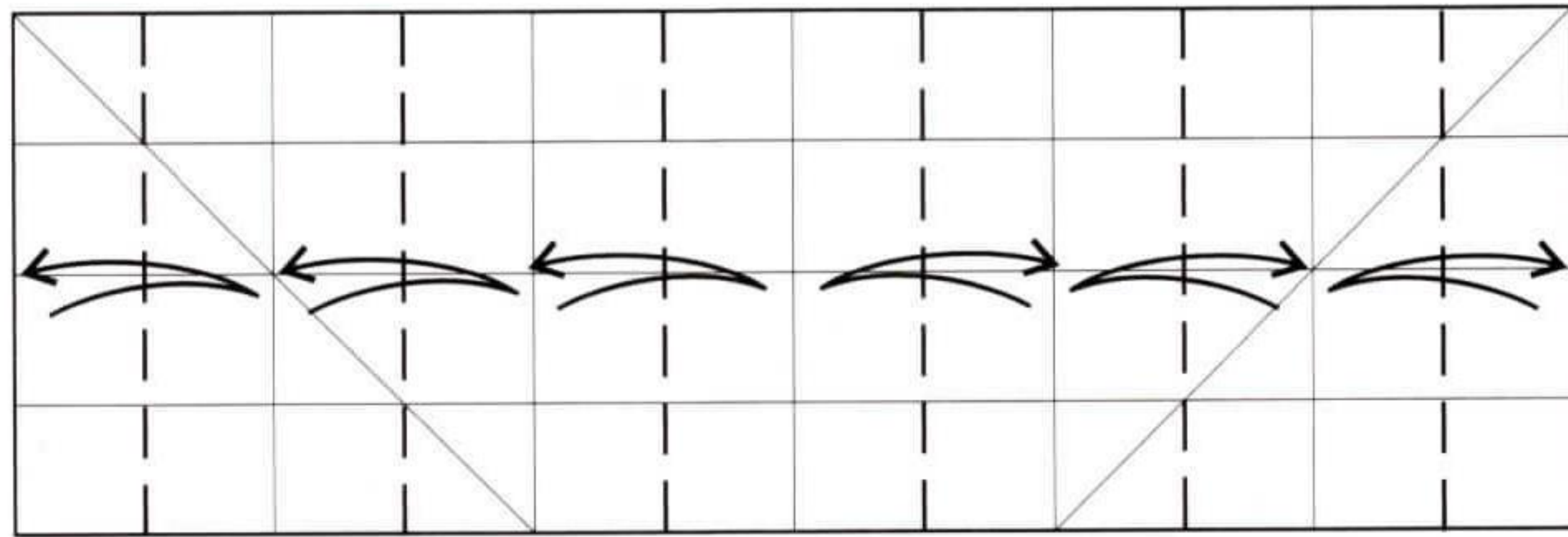

7 Fold and unfold between the creases made previously.

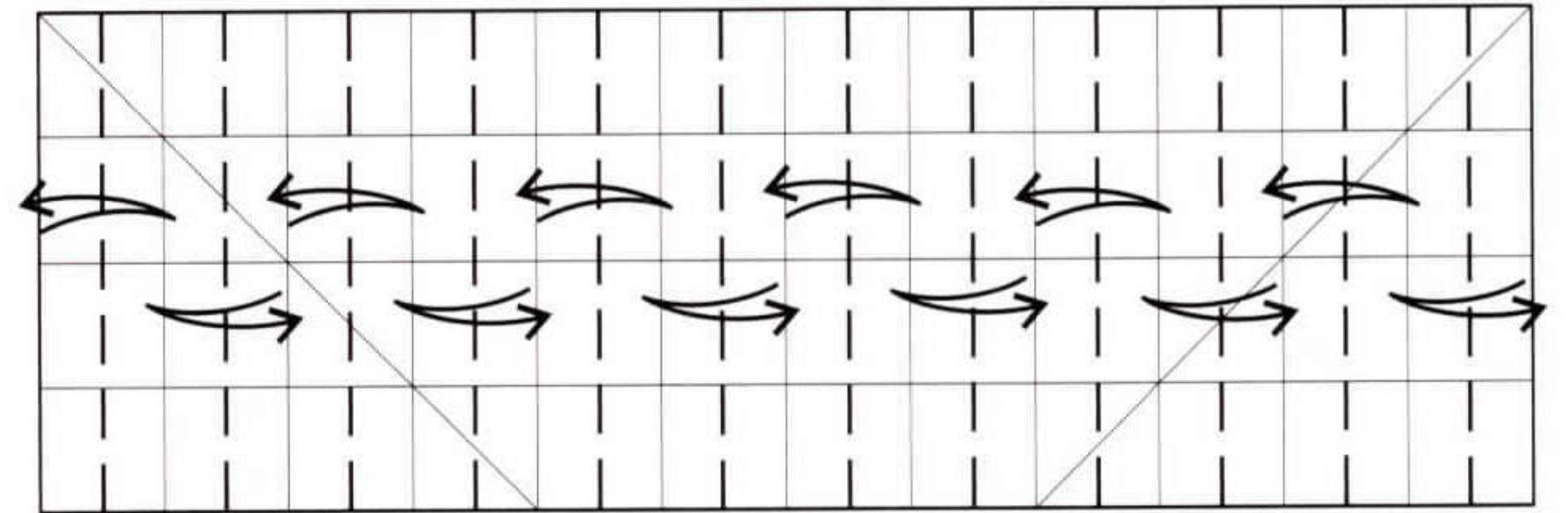

8 Fold and unfold between the creases made previously.

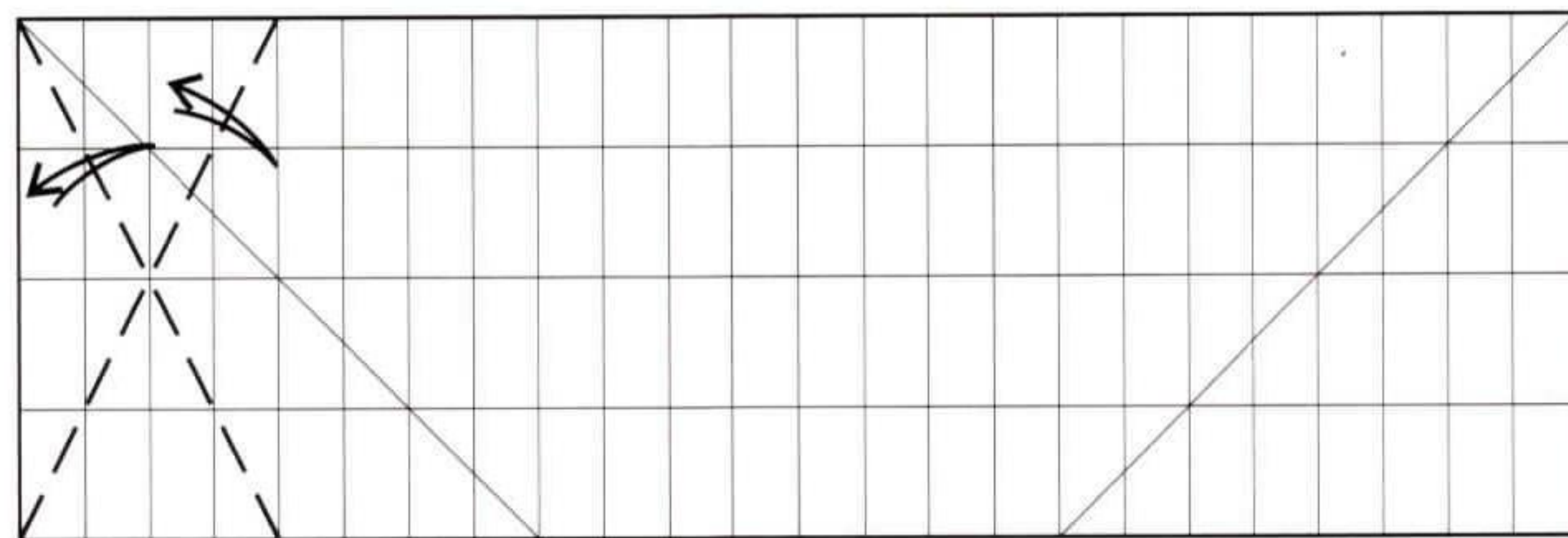

9 Fold and unfold diagonally.

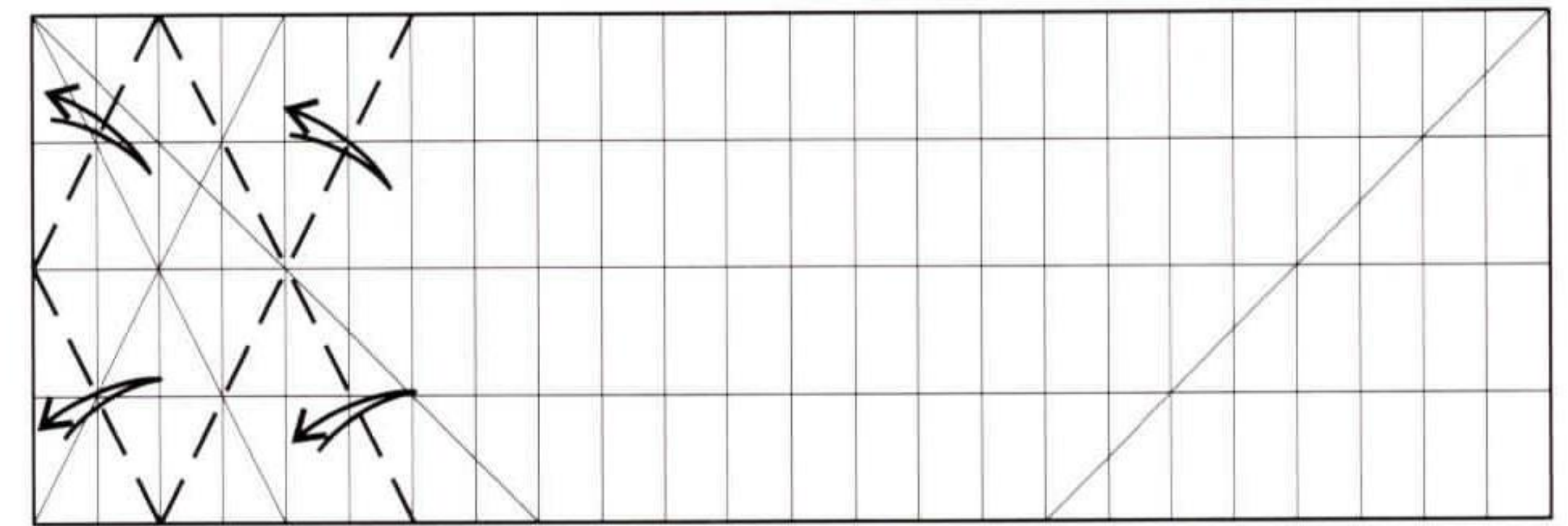

10 Continue folding the diagonals across the rectangle shape.

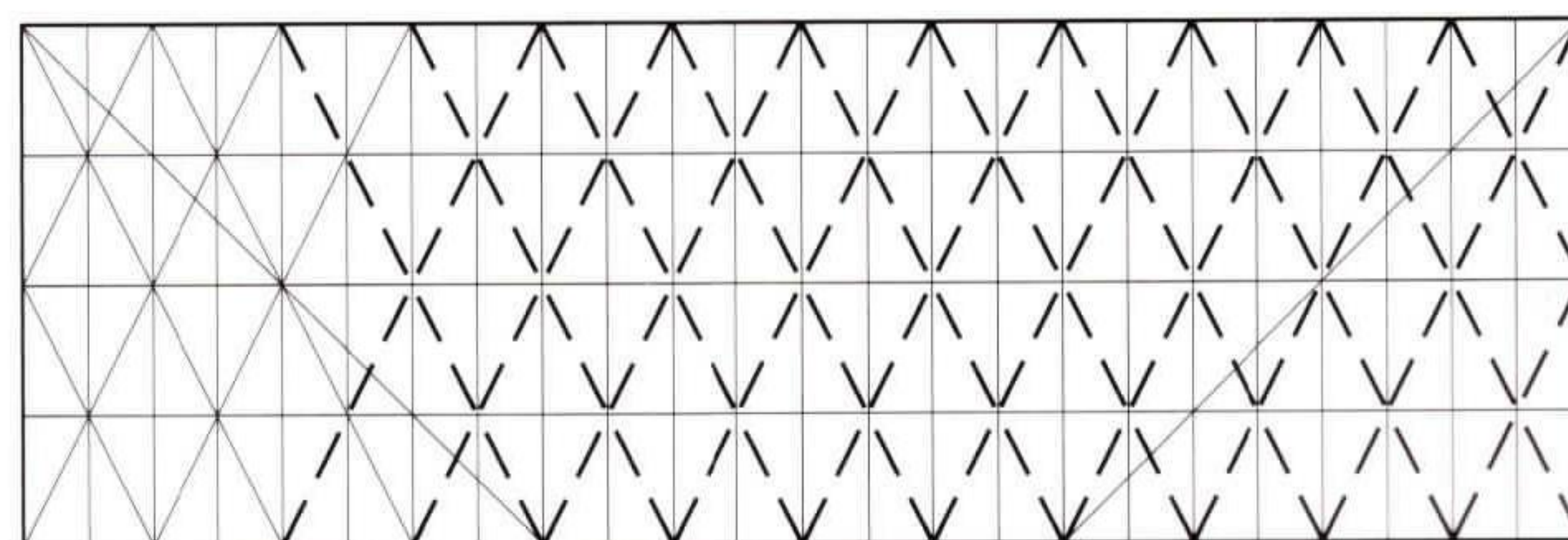

11 Continue the diagonal fold across the rectangle.

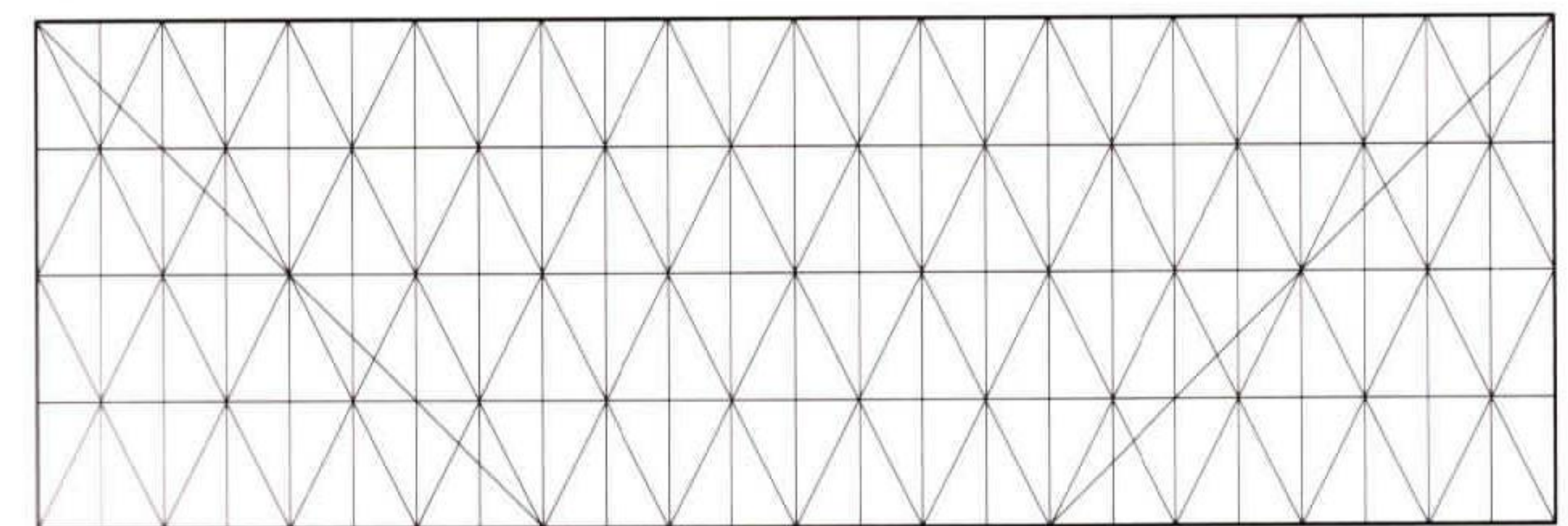

12 Rotate the model by 90°.



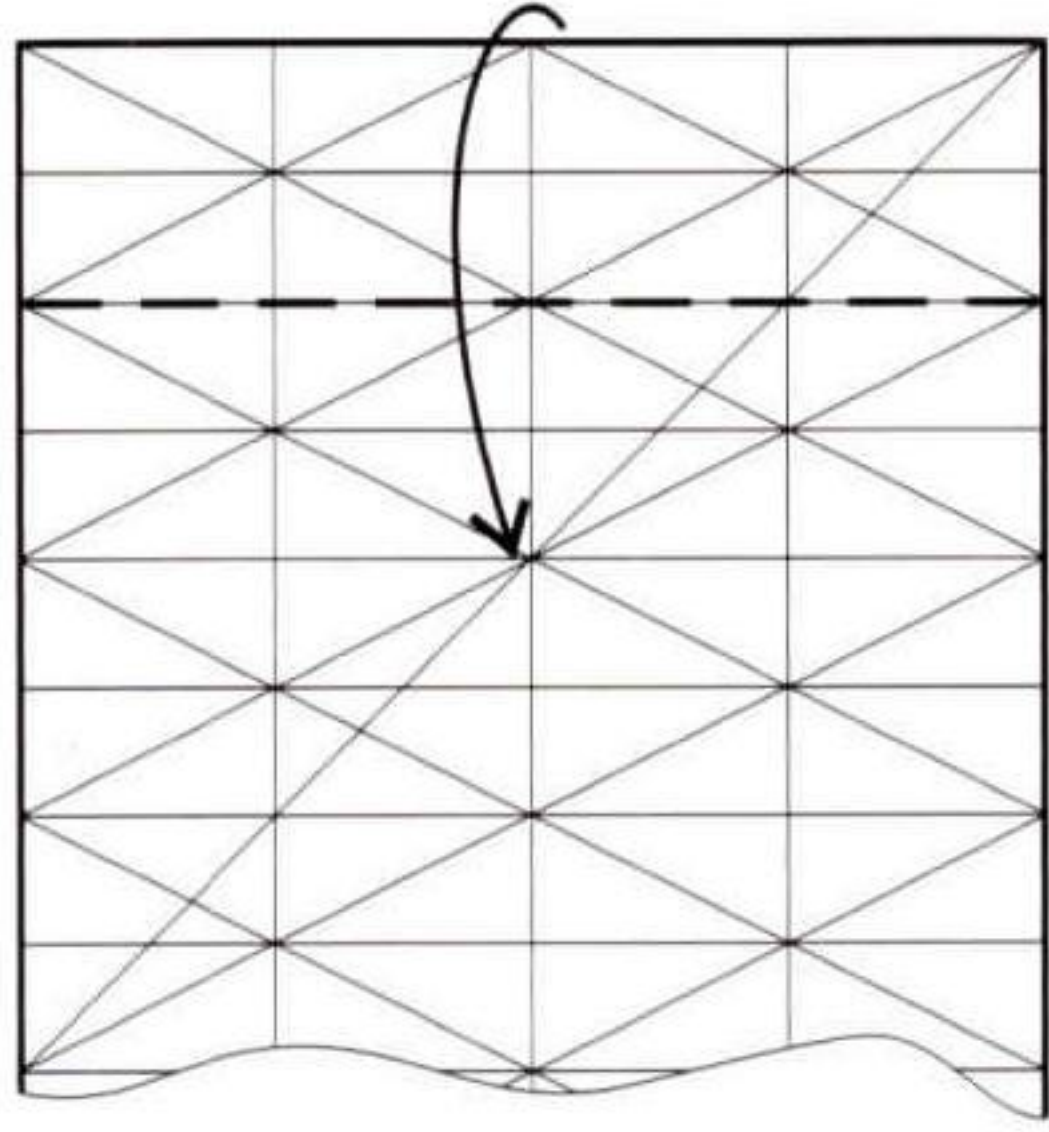
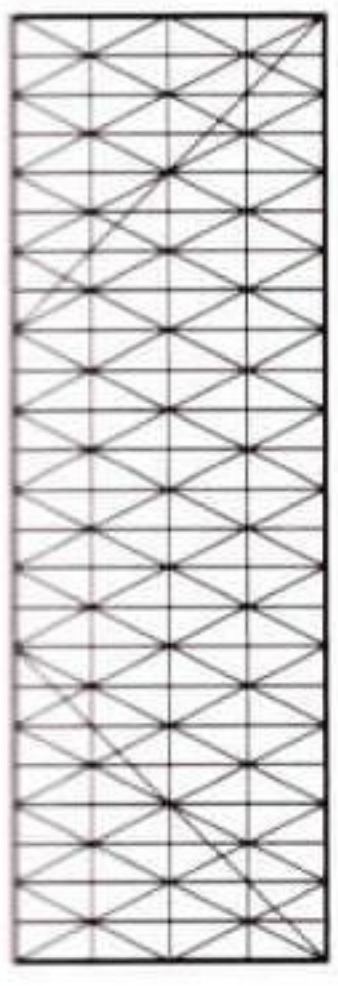

13 The following steps show a detail of the upper section. Fold the top edge down.

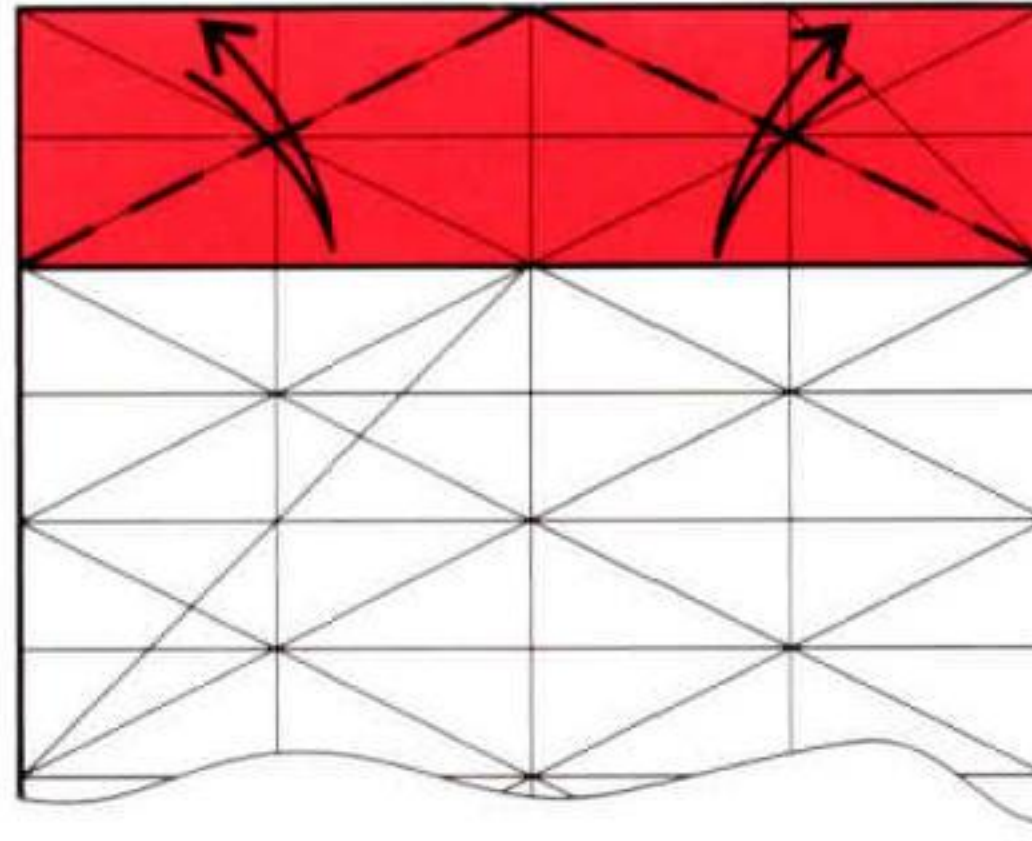

14 Fold and unfold the outer corners of the paper.

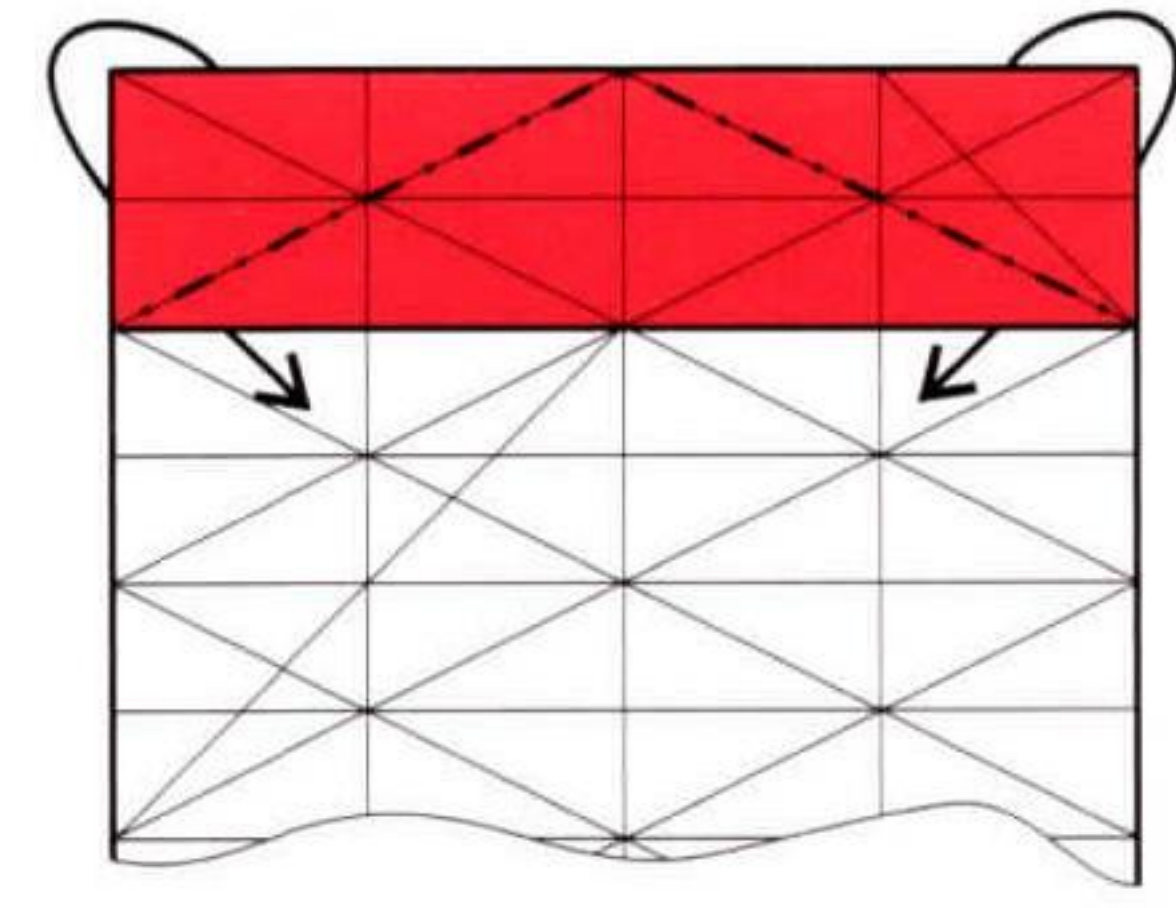

15 Reverse fold the corners inside the folded edge.

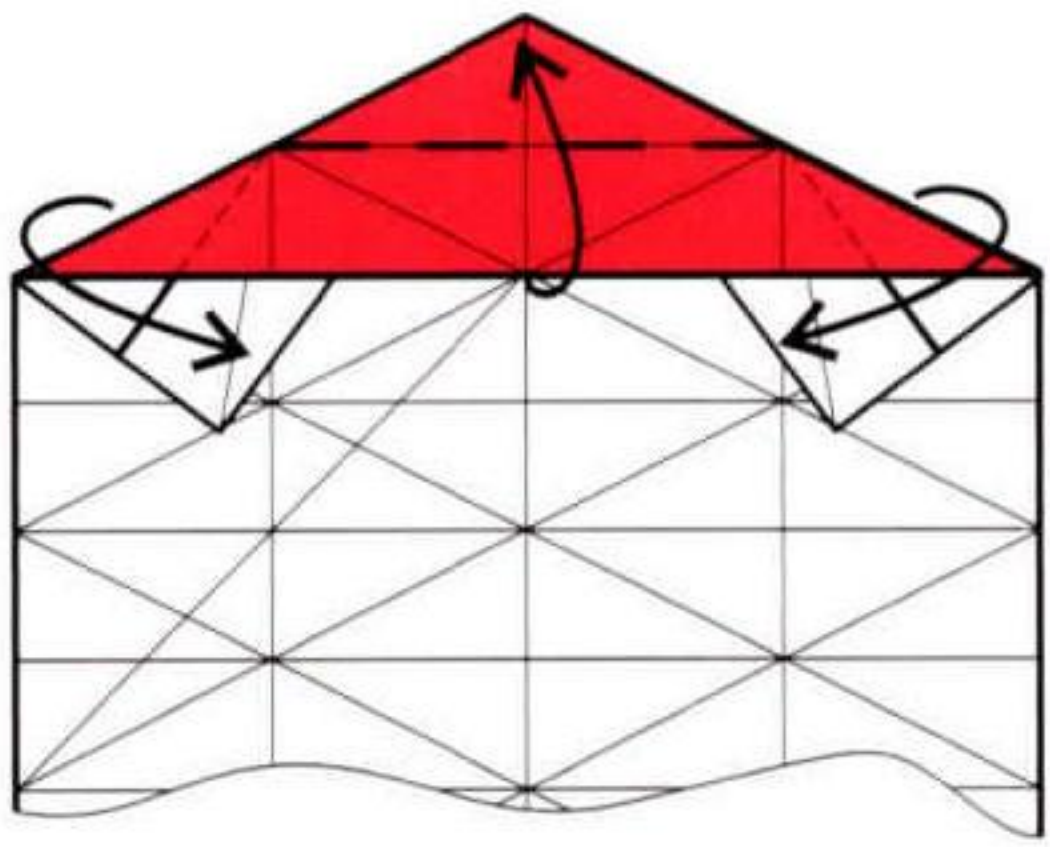

16 Fold the upper layer up to touch the upper point, causing the edges to fold in.

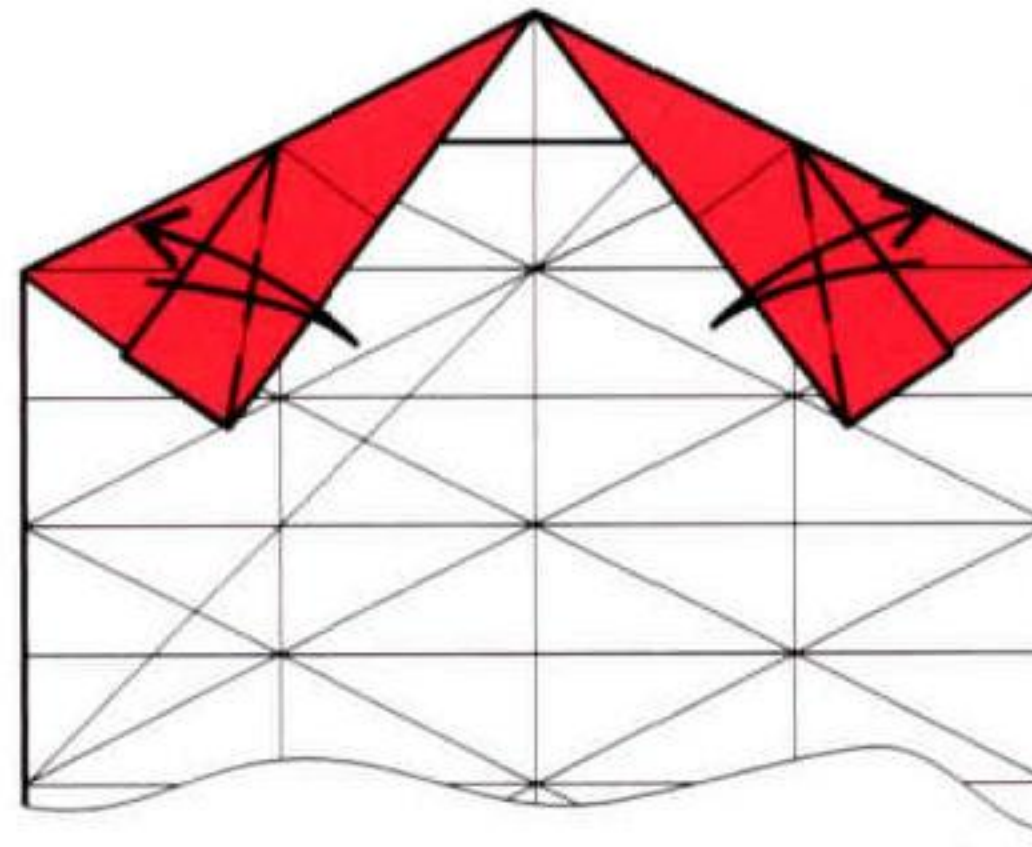

17 Fold and unfold the outer corners of the paper.

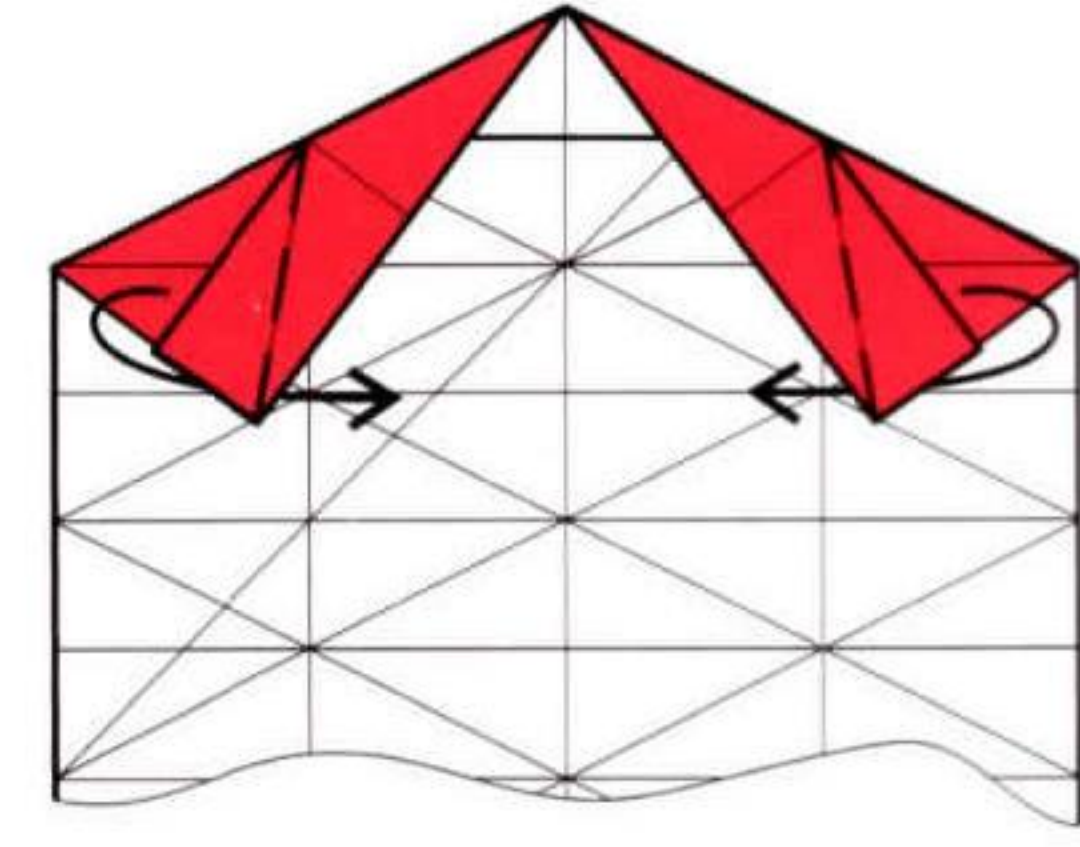

18 Reverse fold the corners inside along the creases made previously.

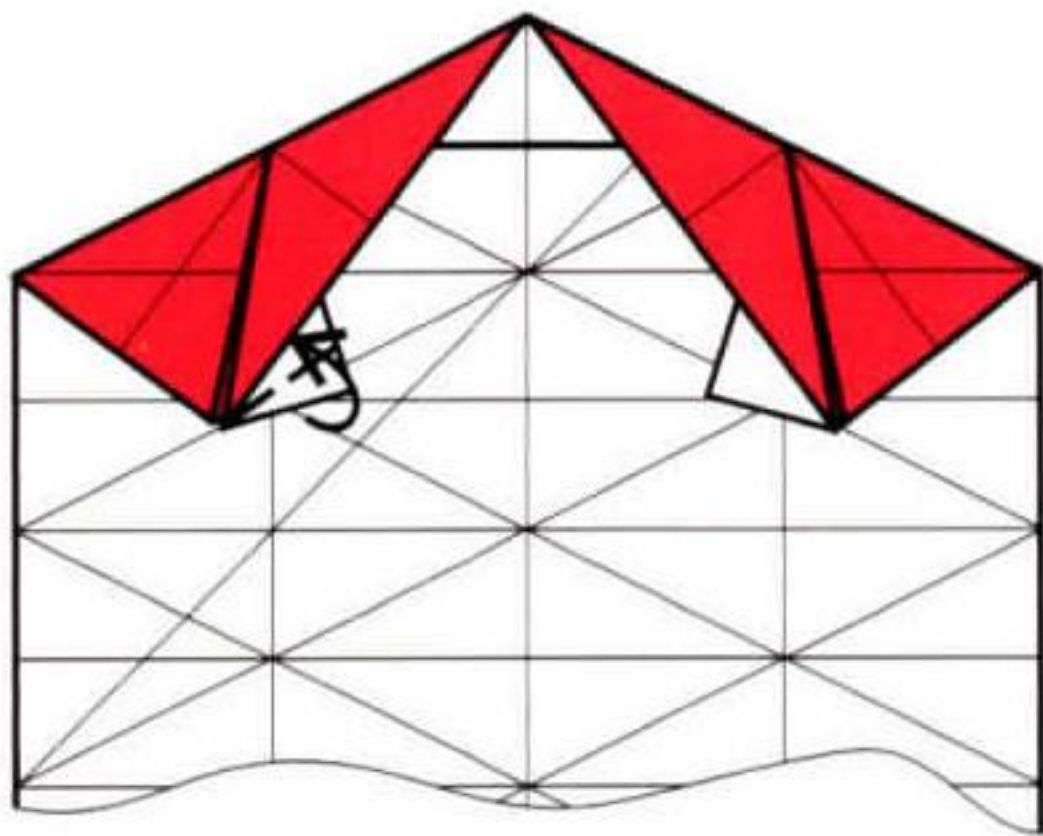

19 Fold the corner in.

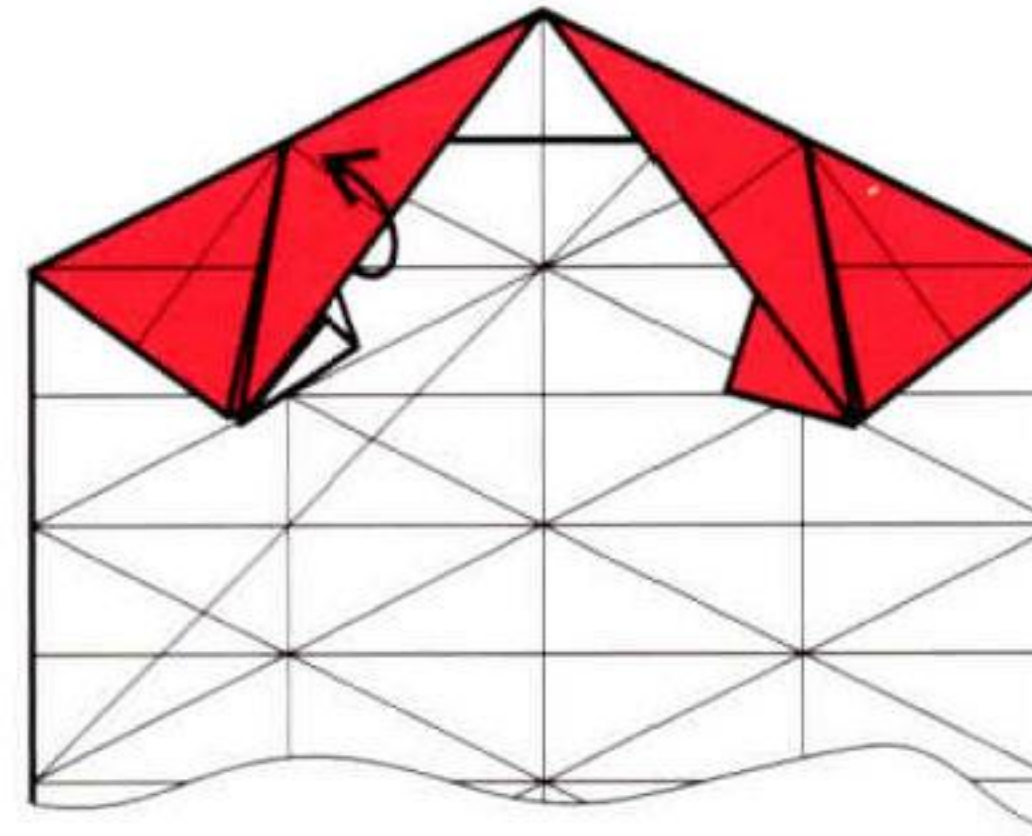

20 Open up the edge above the folded corner.

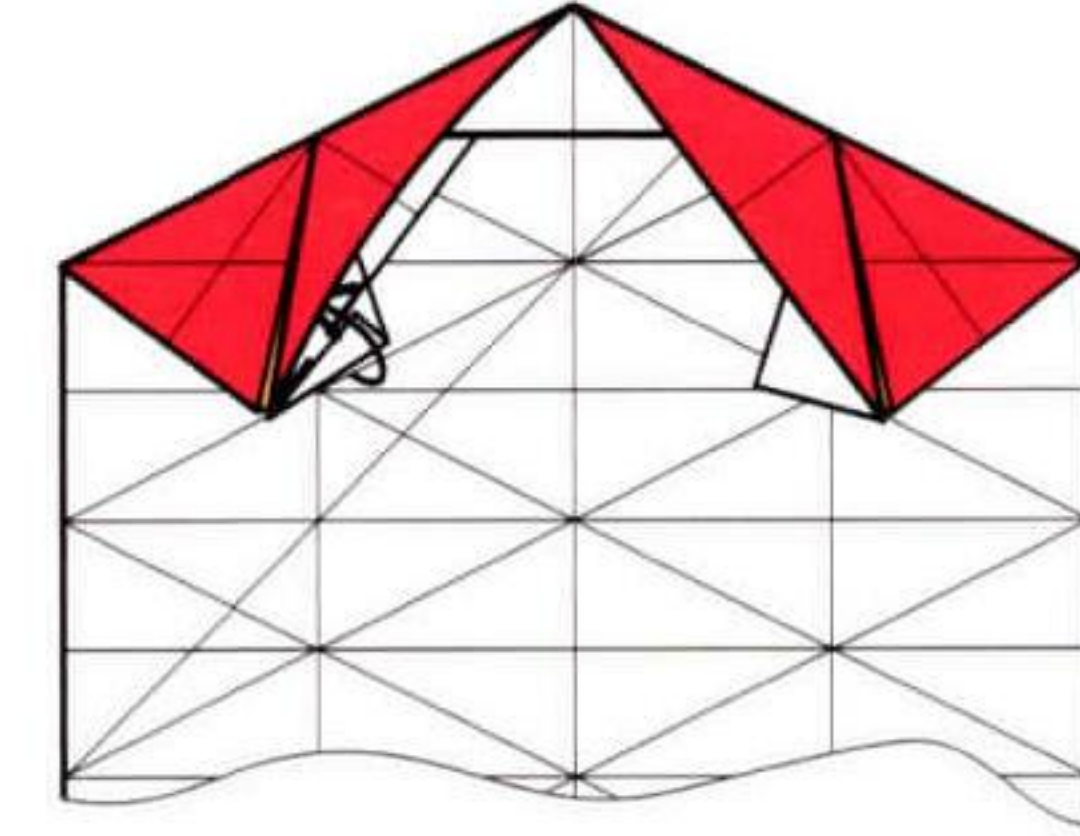

21 Fold the folded corner in between the layers of the adjacent edge.

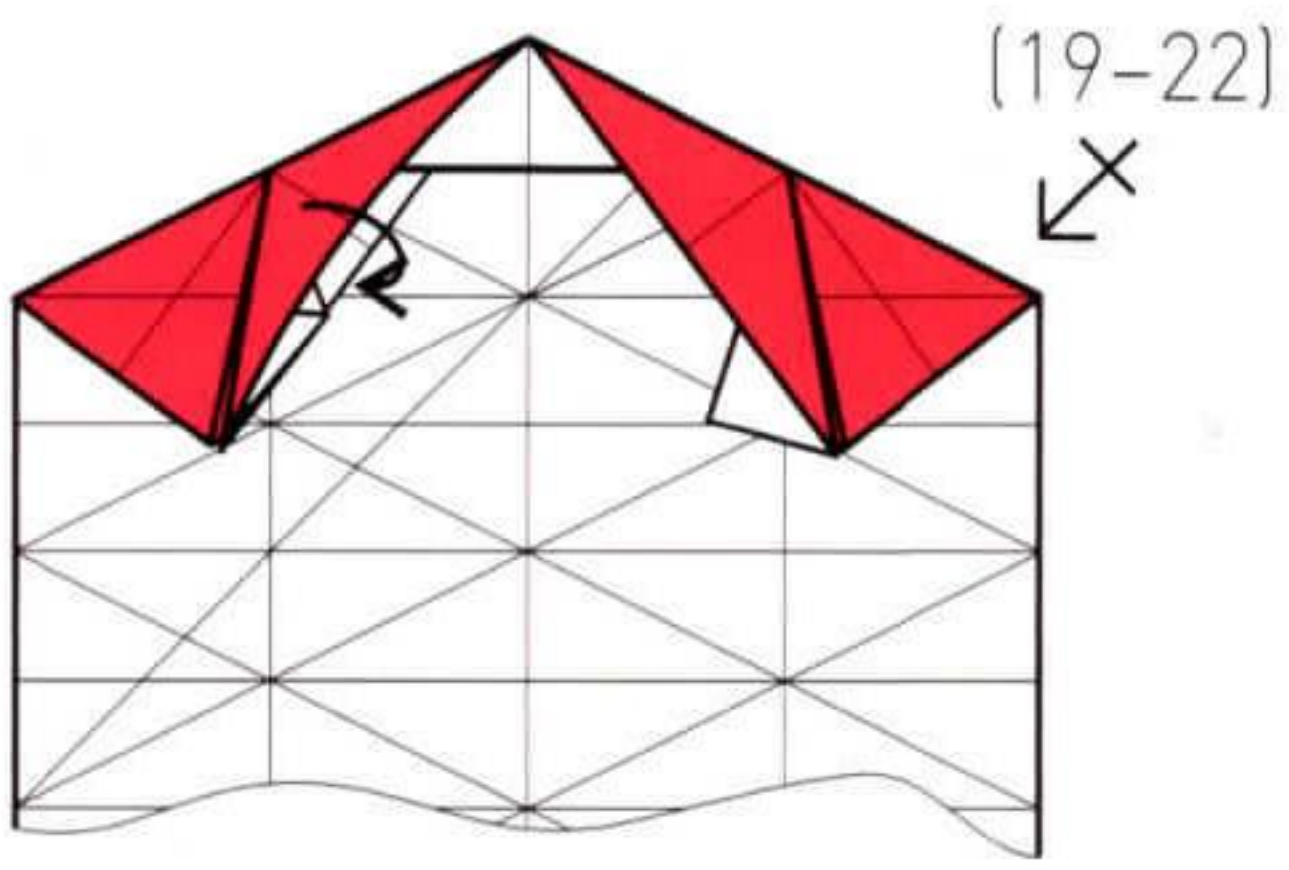

22 Fold the edge back and then repeat steps 19 to 22 on the other side.

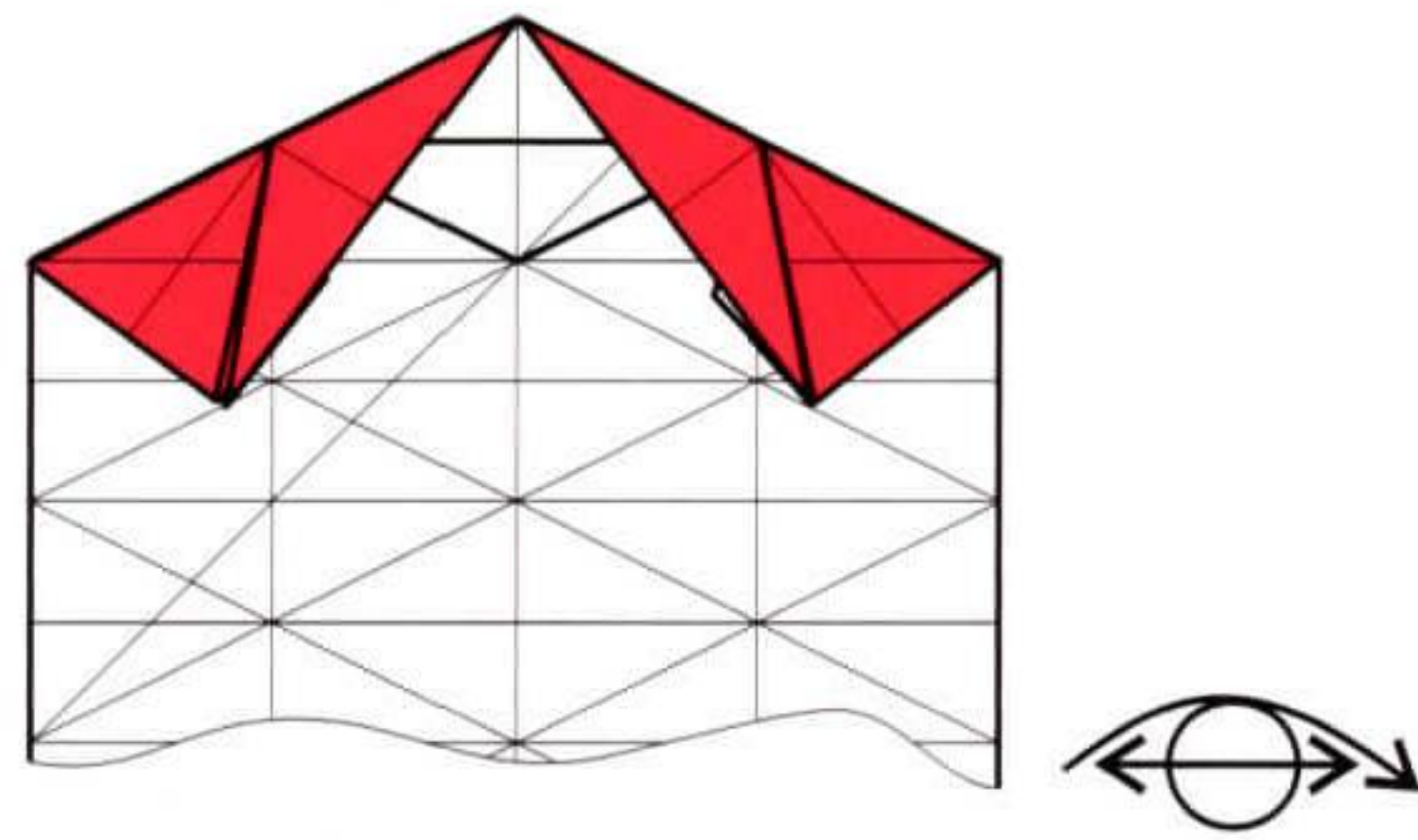

23 Turn the model over left to right.

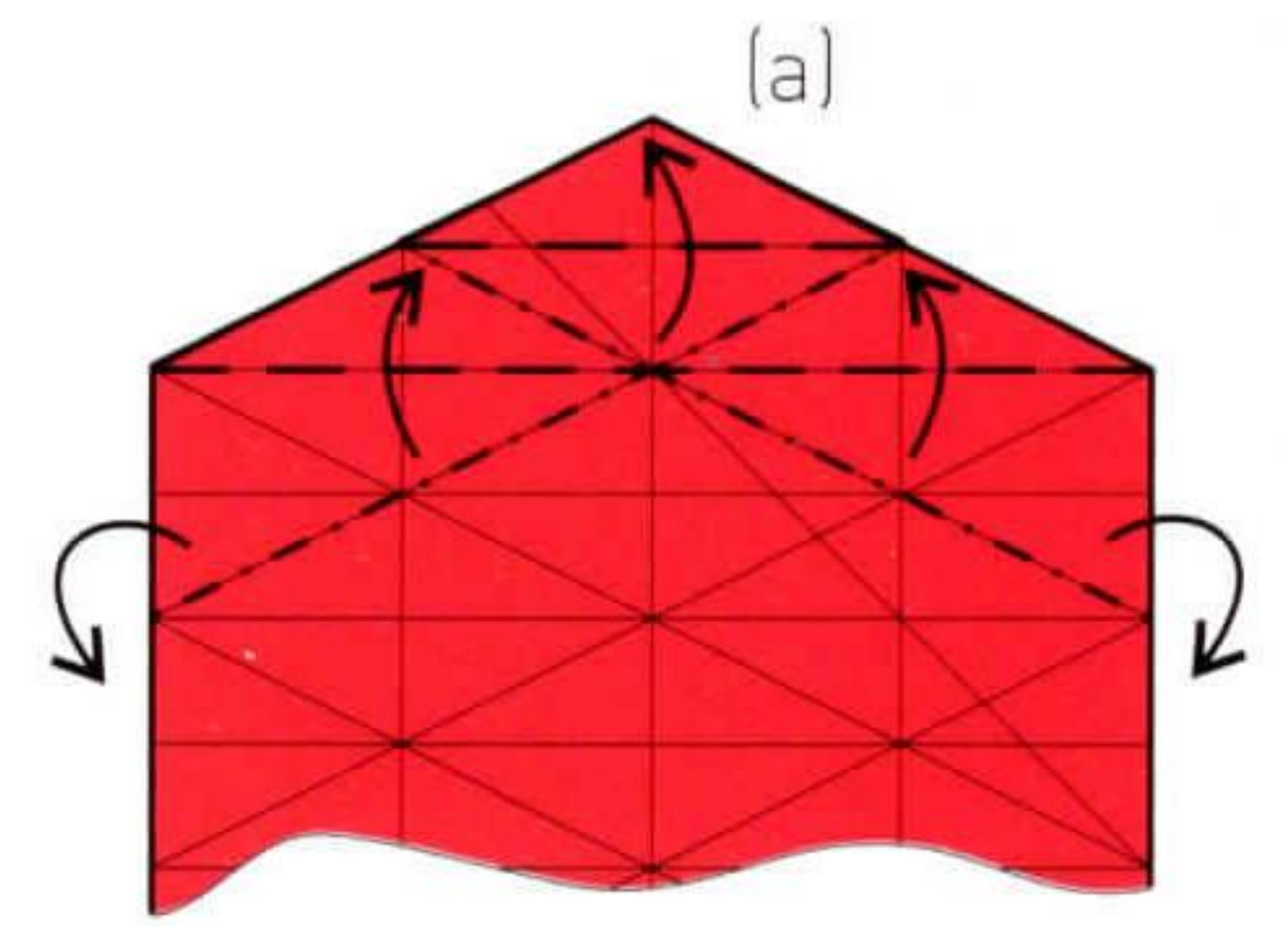

24 Fold upper edge (a) up and fold up the paper below along the creases made previously.

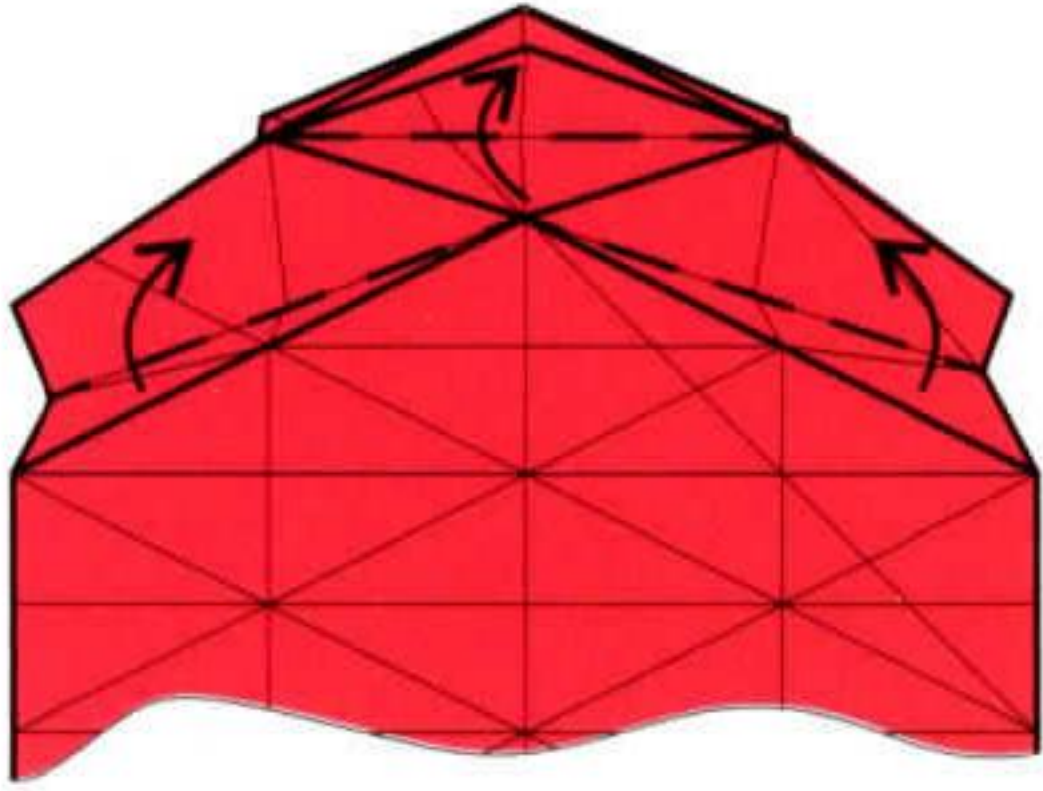

25 This shows the previous fold in progress.

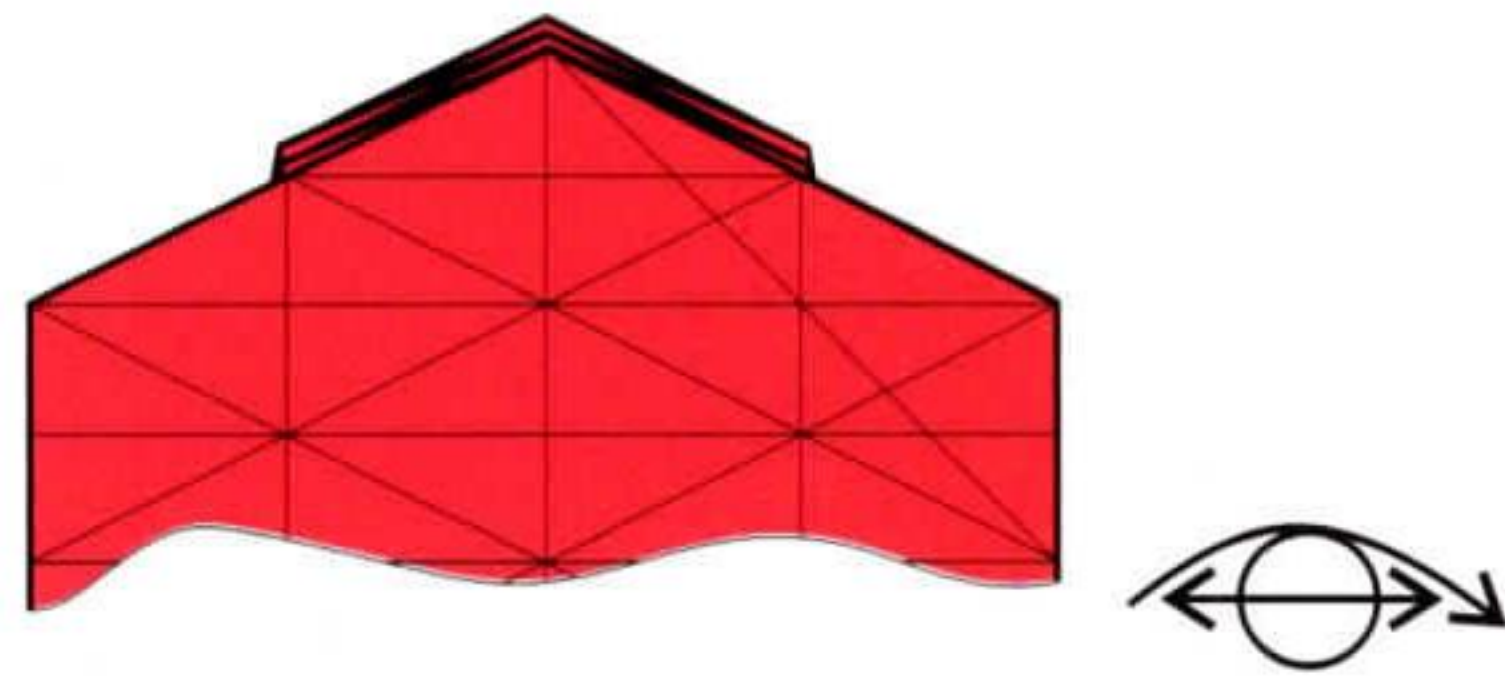

26 Turn the model over left to right.

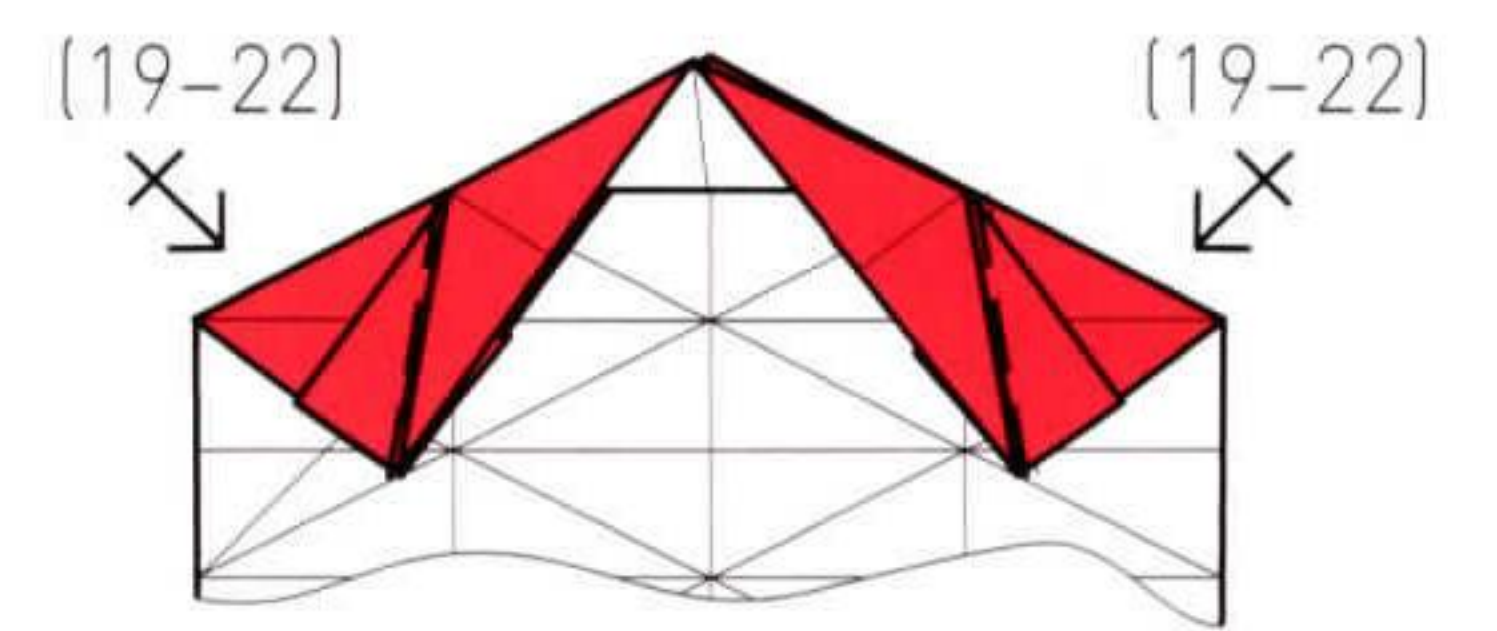

27 Repeat steps 19 to 22 on both sides, folding and locking the corners.

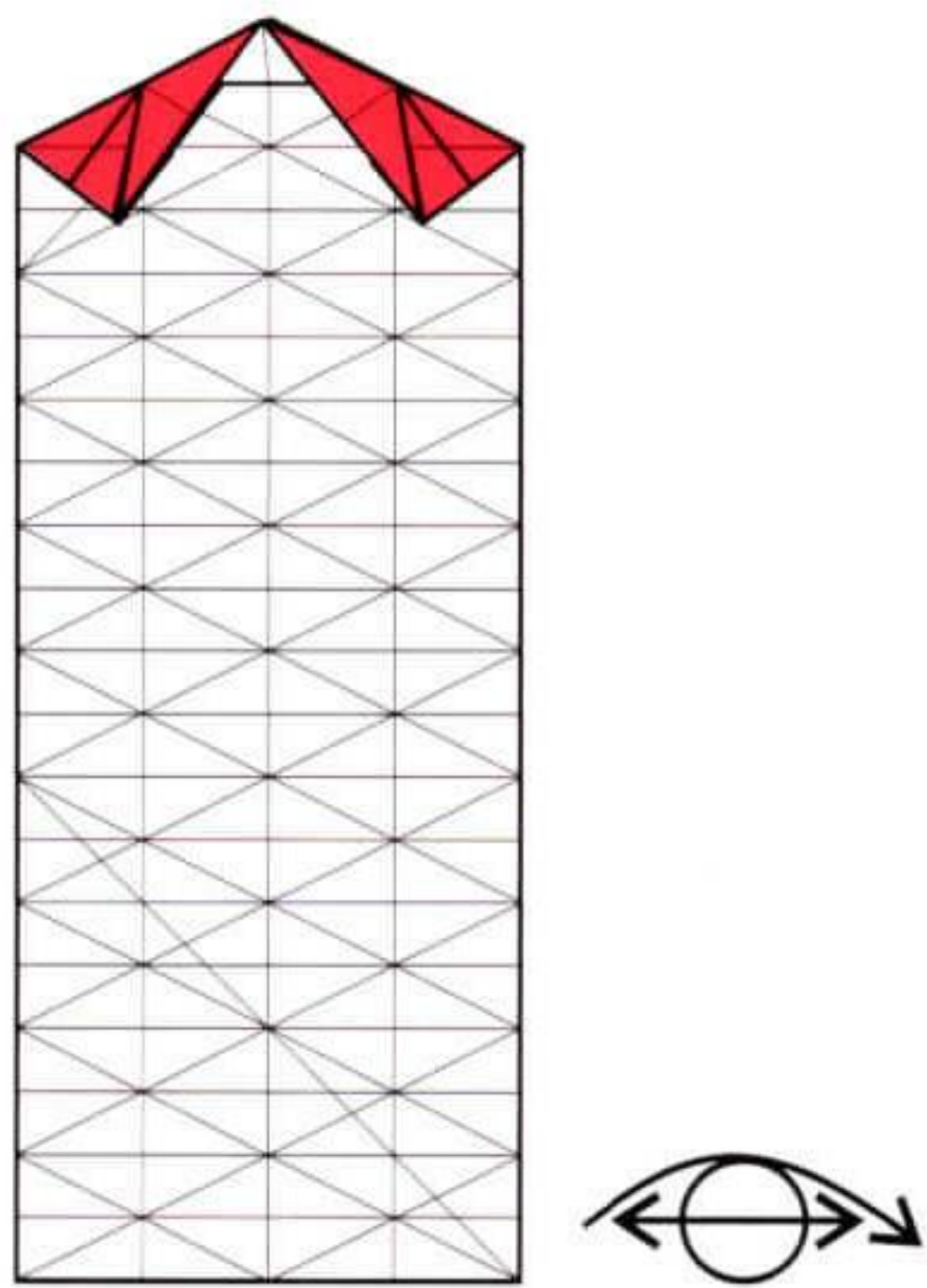

28 Turn the model over left to right.

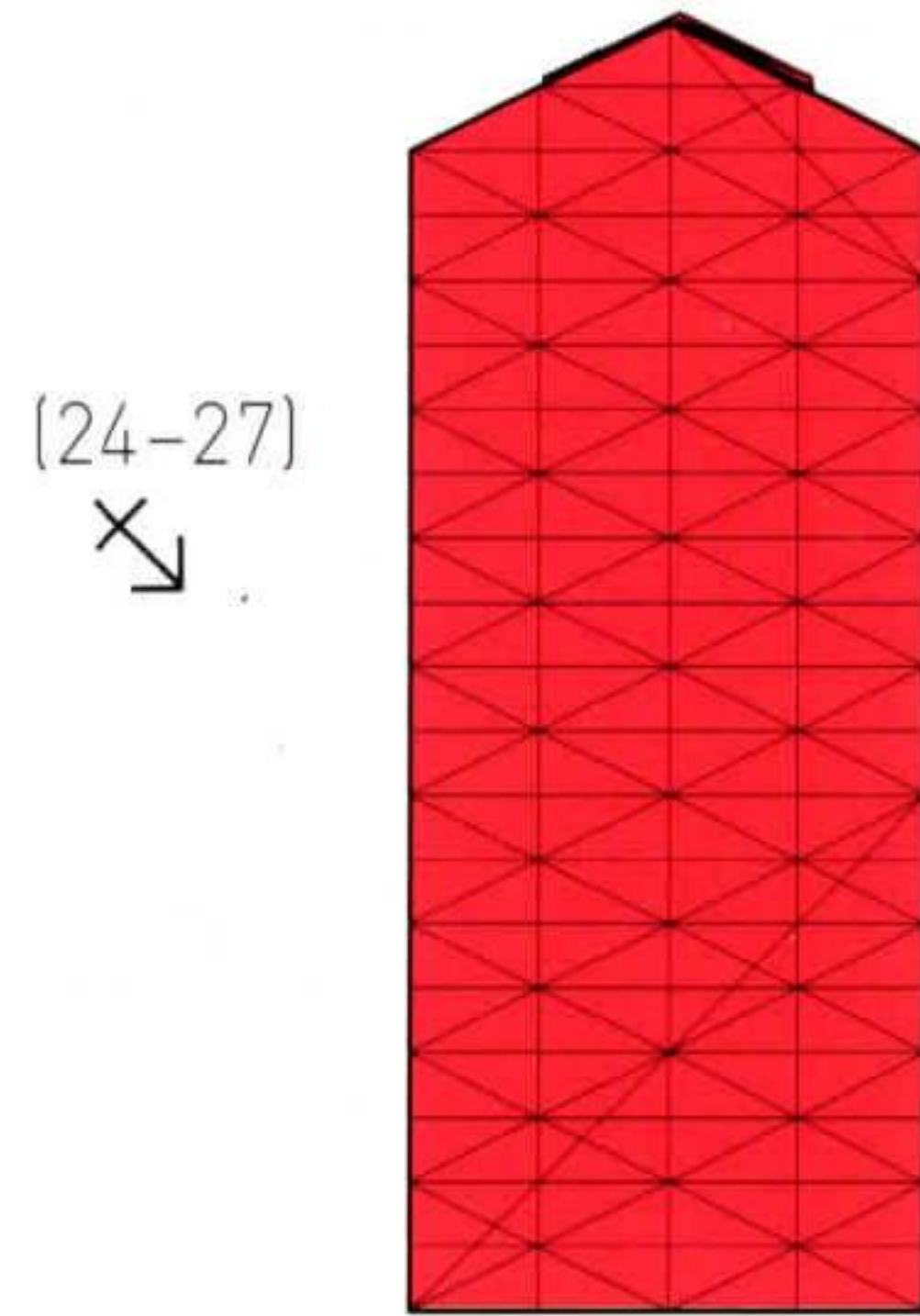

29 Fold the rest of the paper up, repeating steps 24 to 27 along the length of the model.

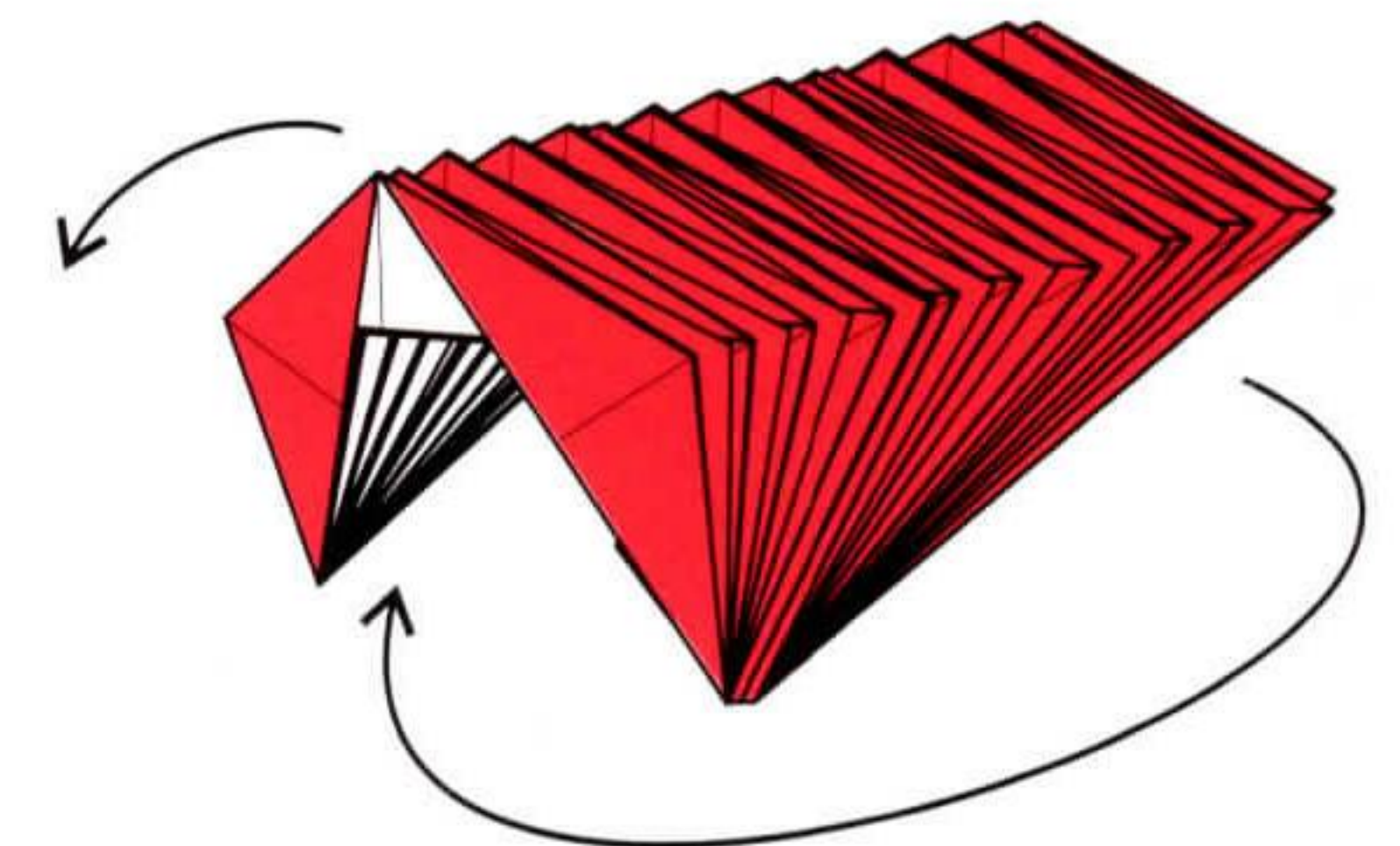

30 Curve the model to align the front and rear faces.

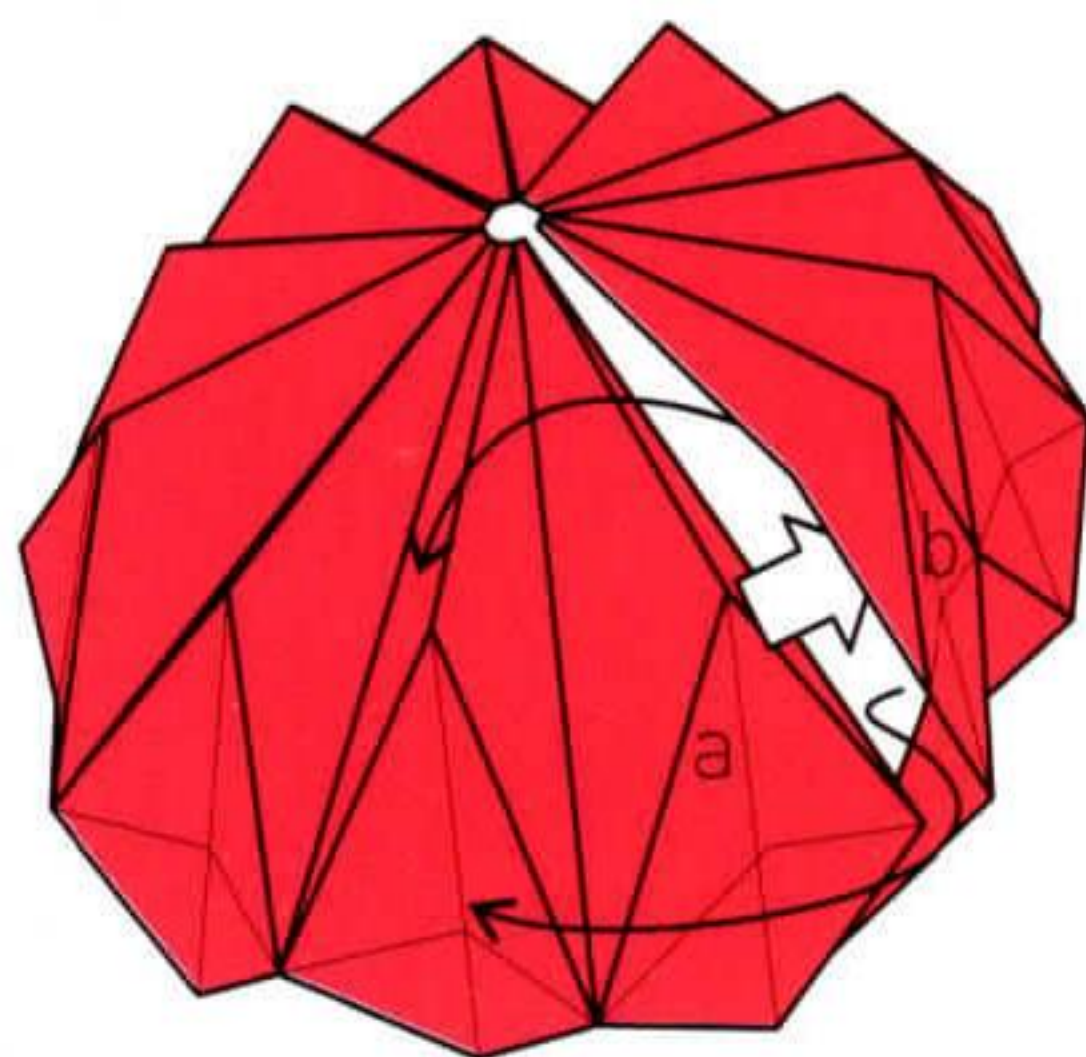

31 Tuck one section (a) inside the other (b); see opposite.

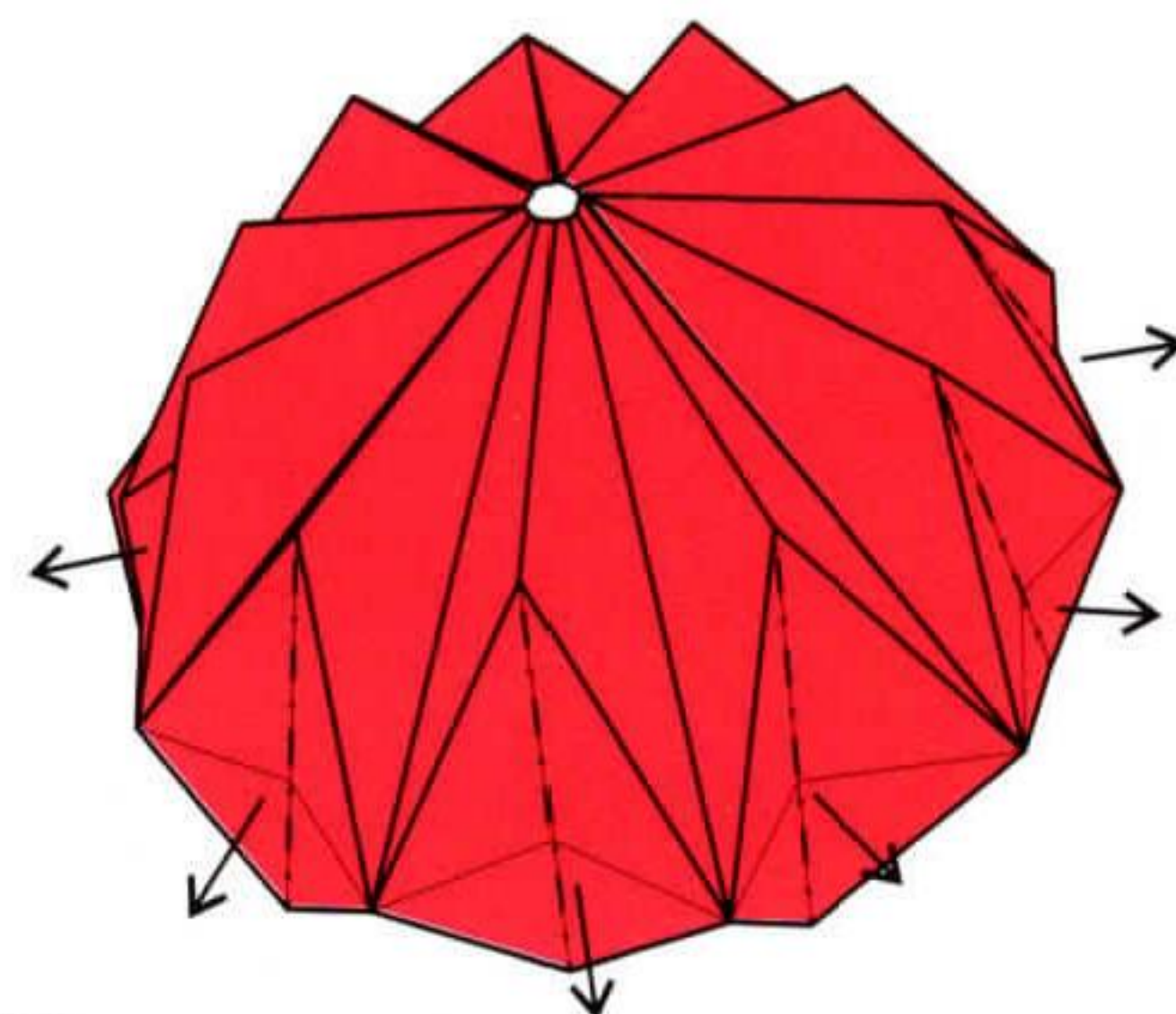

32 Apply pressure to the top and bottom, and pop out the corners around the middle to add more rigidity.



33 Complete.

GEO BALL ASSEMBLY

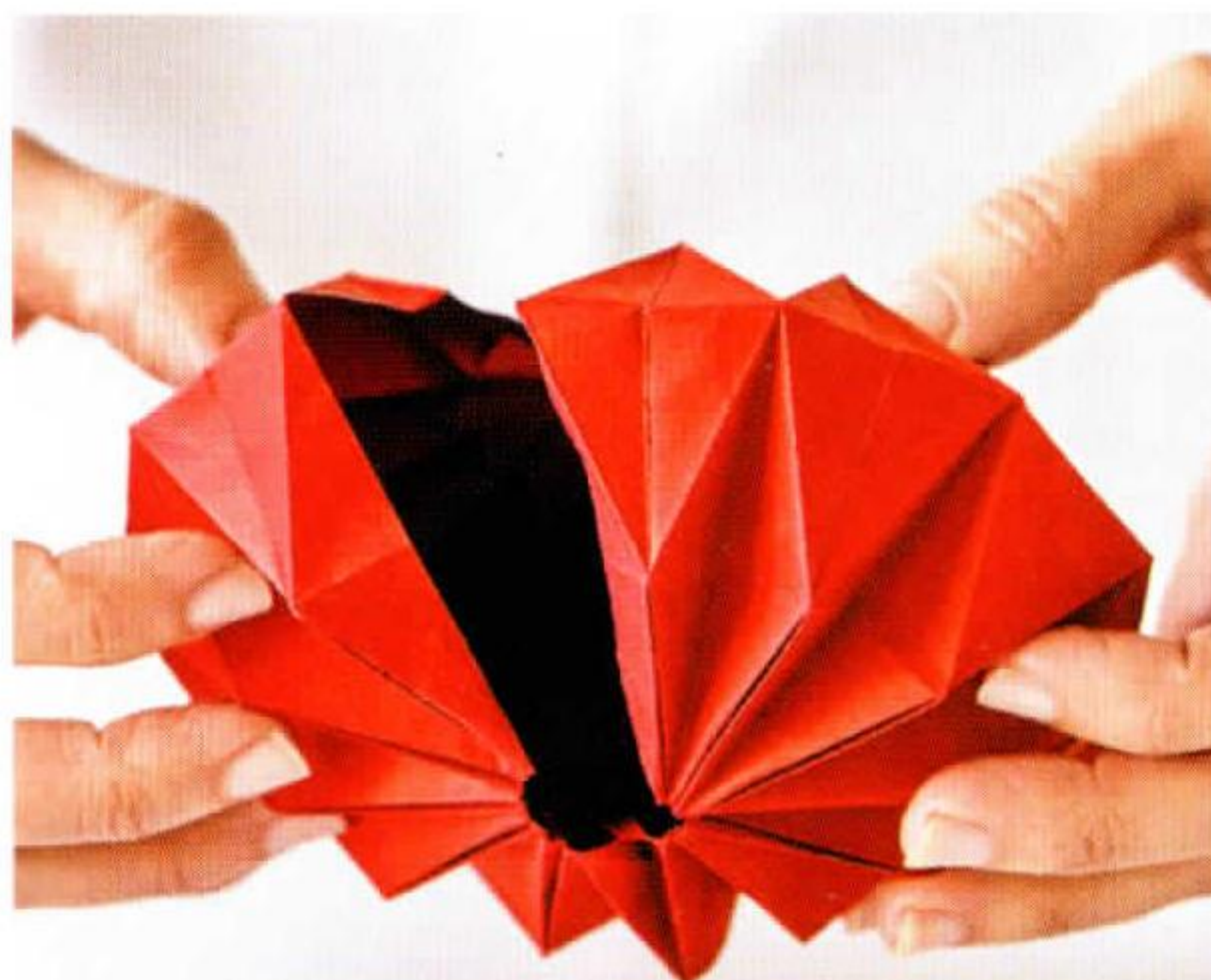

31a

Align the two opposite ends, squeezing the model until both ends are roughly the same size.



31b

Insert one end into the other. Match the ridges of one end with the equivalent in the other.

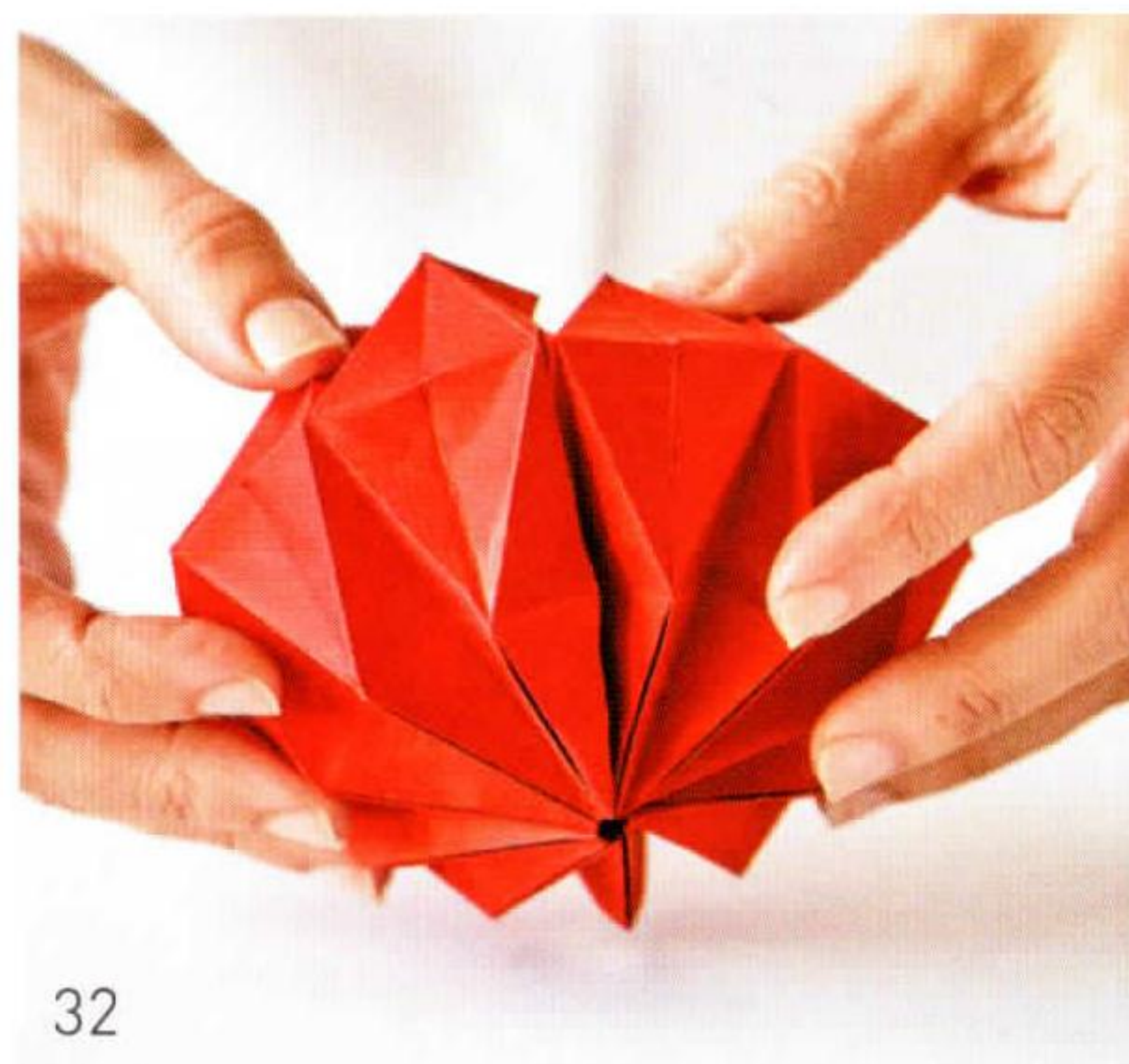

32

When the two ends are aligned, apply pressure at both ends to match and fit them together to complete the ball.



Icosahedron

The icosahedron works through rotational symmetry. The two sides of the model fold as a mirror image of each other. The final assembly involves one end being tucked into the other and can be a bit tricky to achieve, but it does fit together neatly.

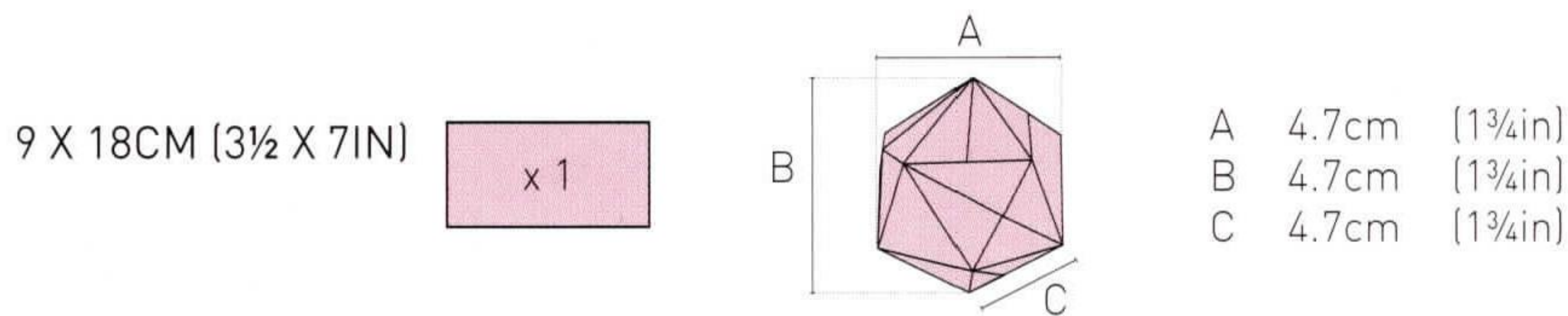

START WITH A 2 X 1 RECTANGLE, COLOURED SIDE DOWN

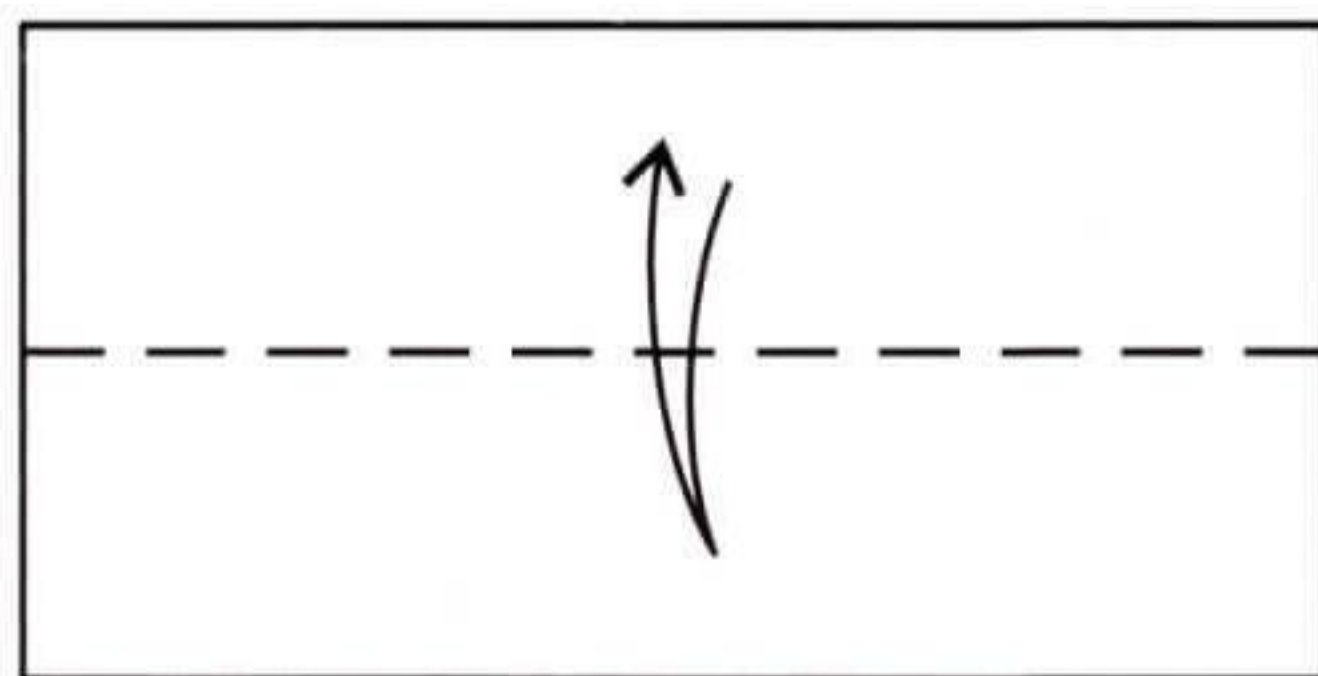

1 Fold and unfold the rectangle in half lengthwise.

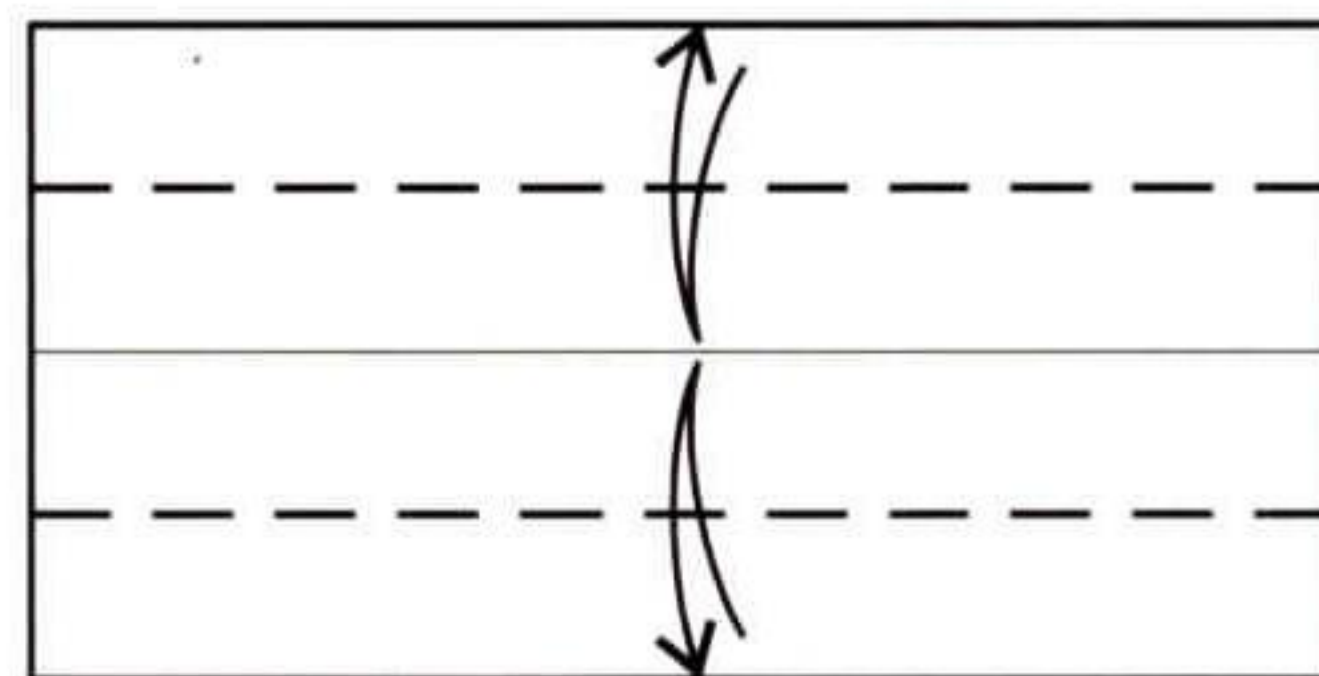

2 Fold and unfold the edges in to the middle crease.

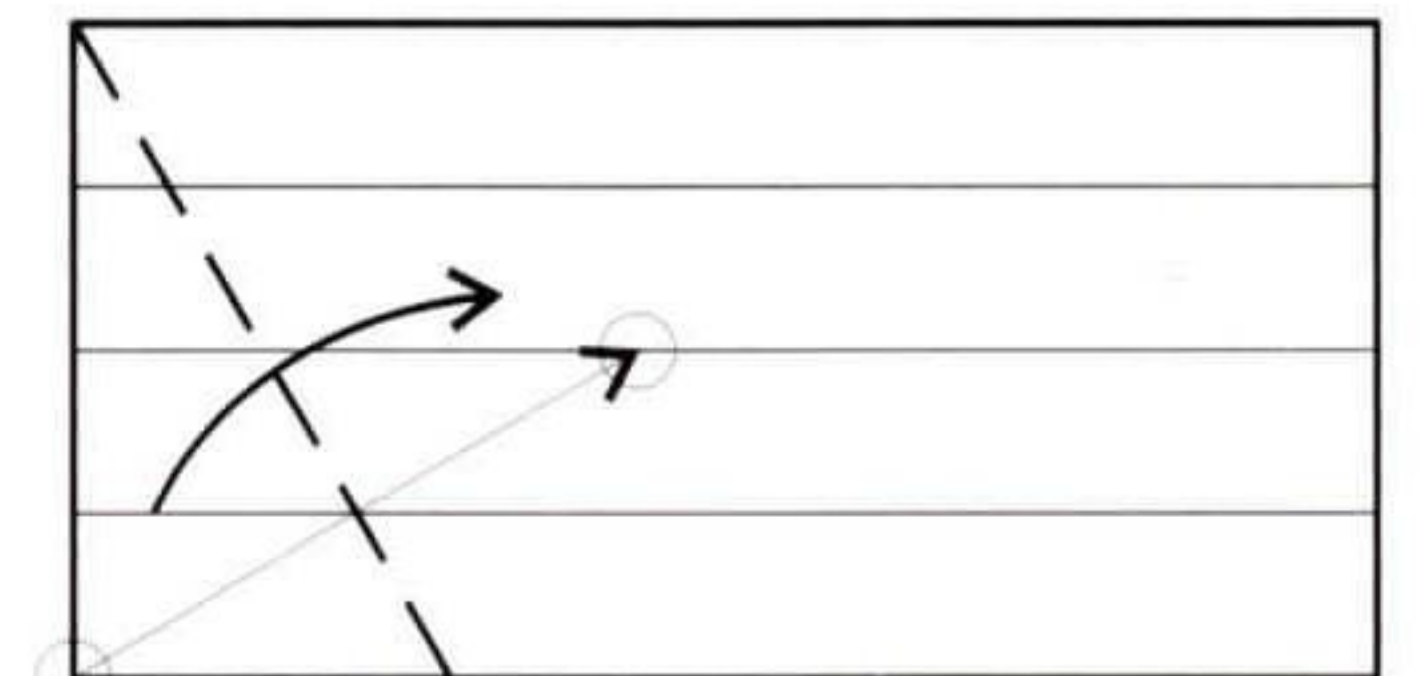

3 Fold the lower corner up to touch the middle crease. The fold should start from the opposite top corner.

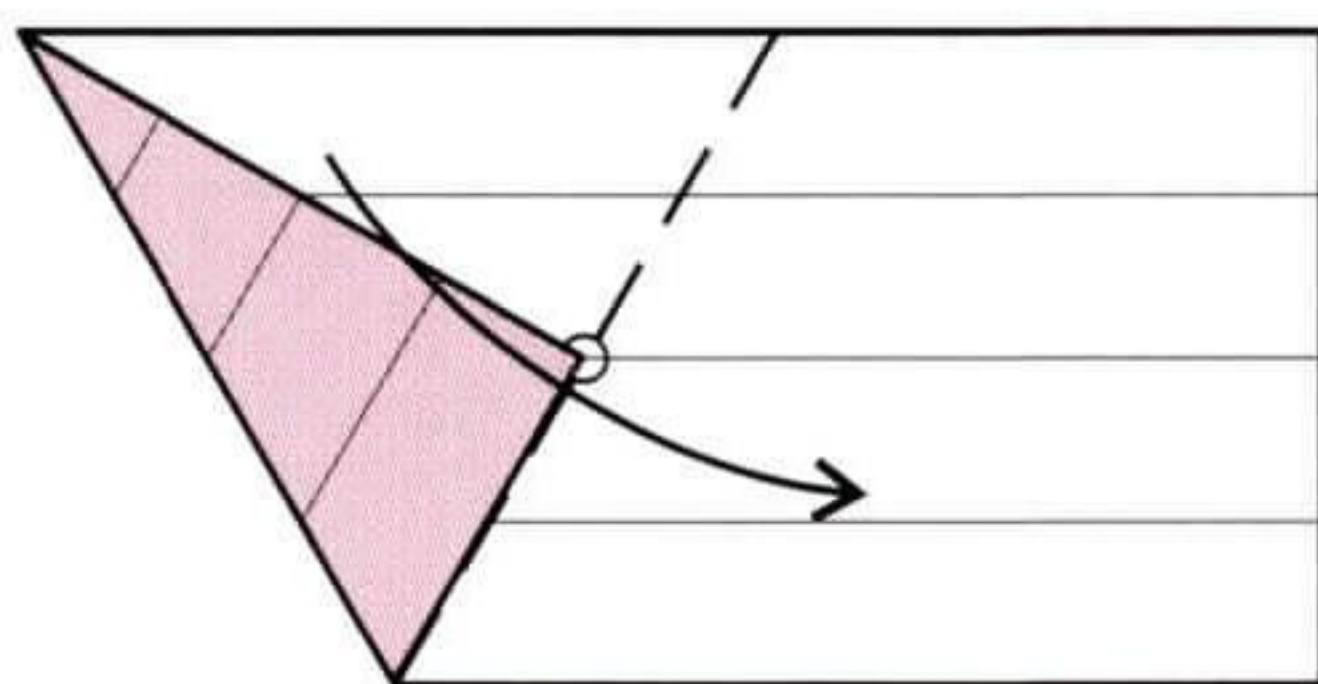

4 Fold the upper section over along the edge.

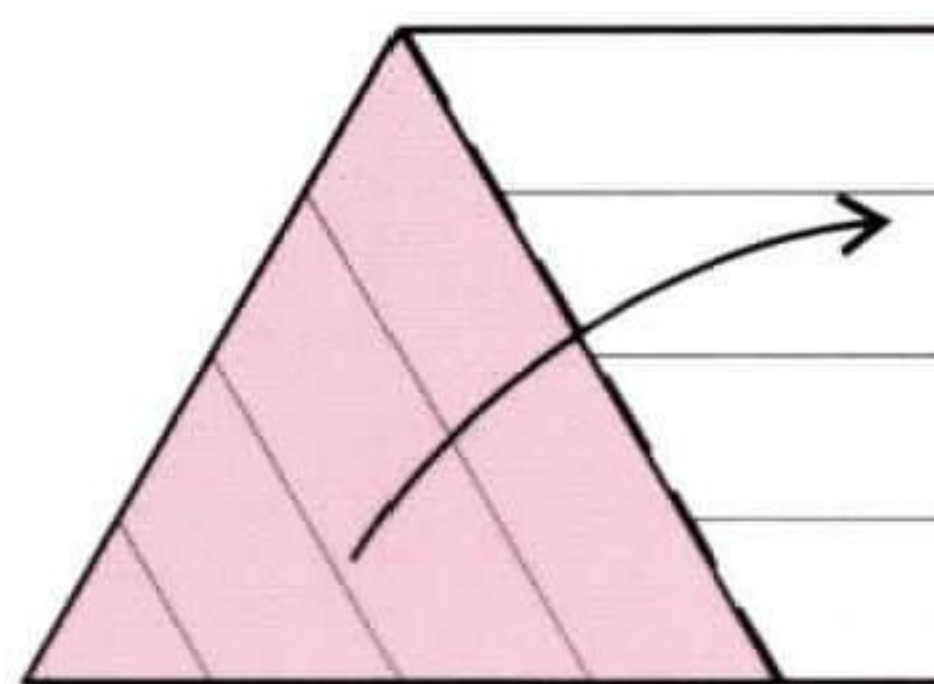

5 Fold the section over the edge again.

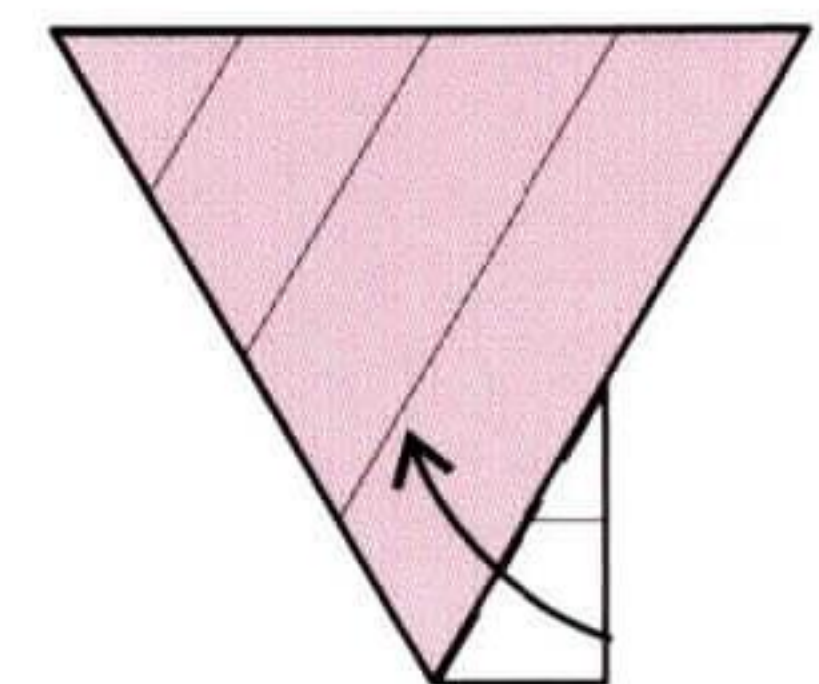

6 Fold the outer corner in over the edge of the triangle.

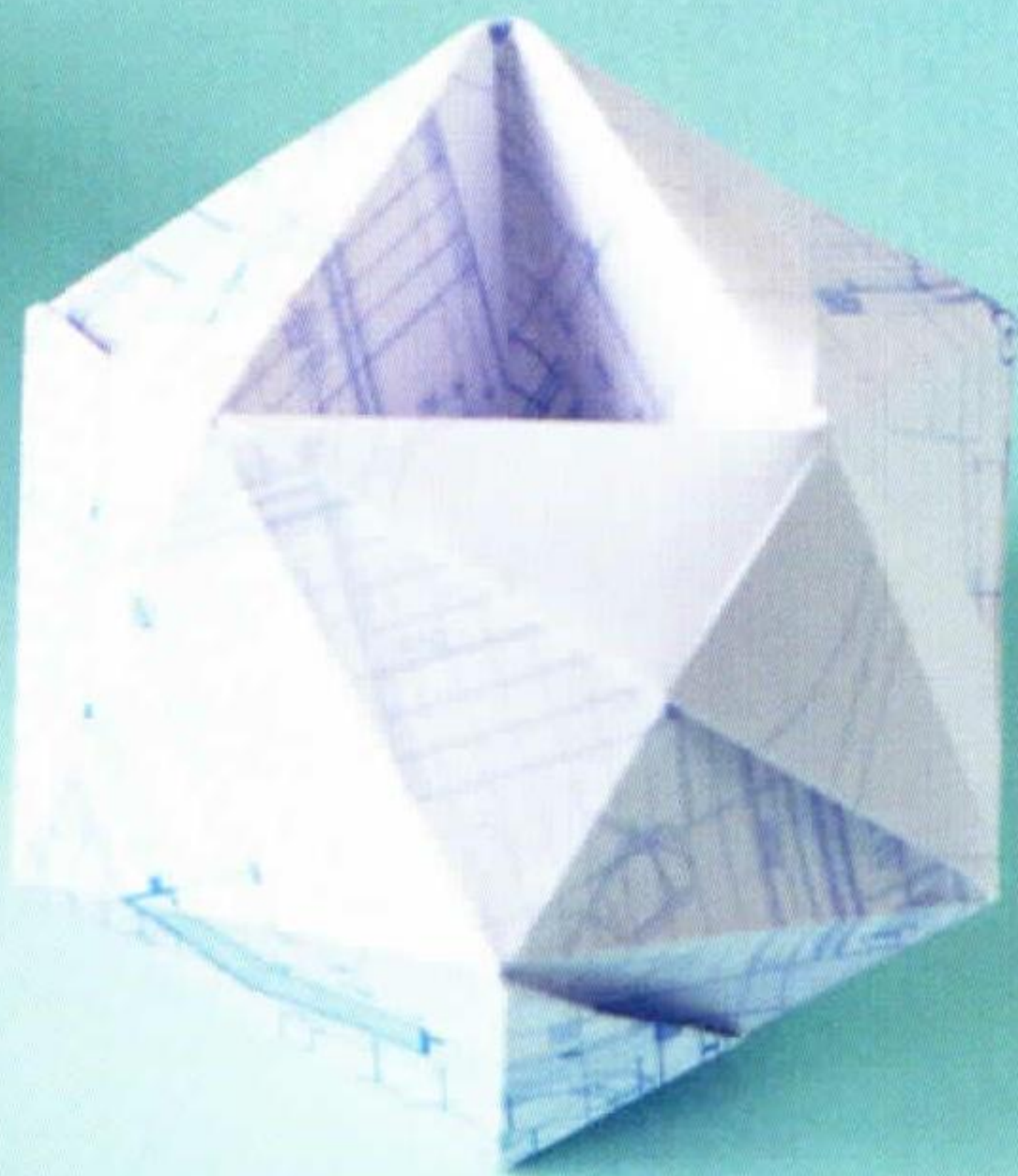
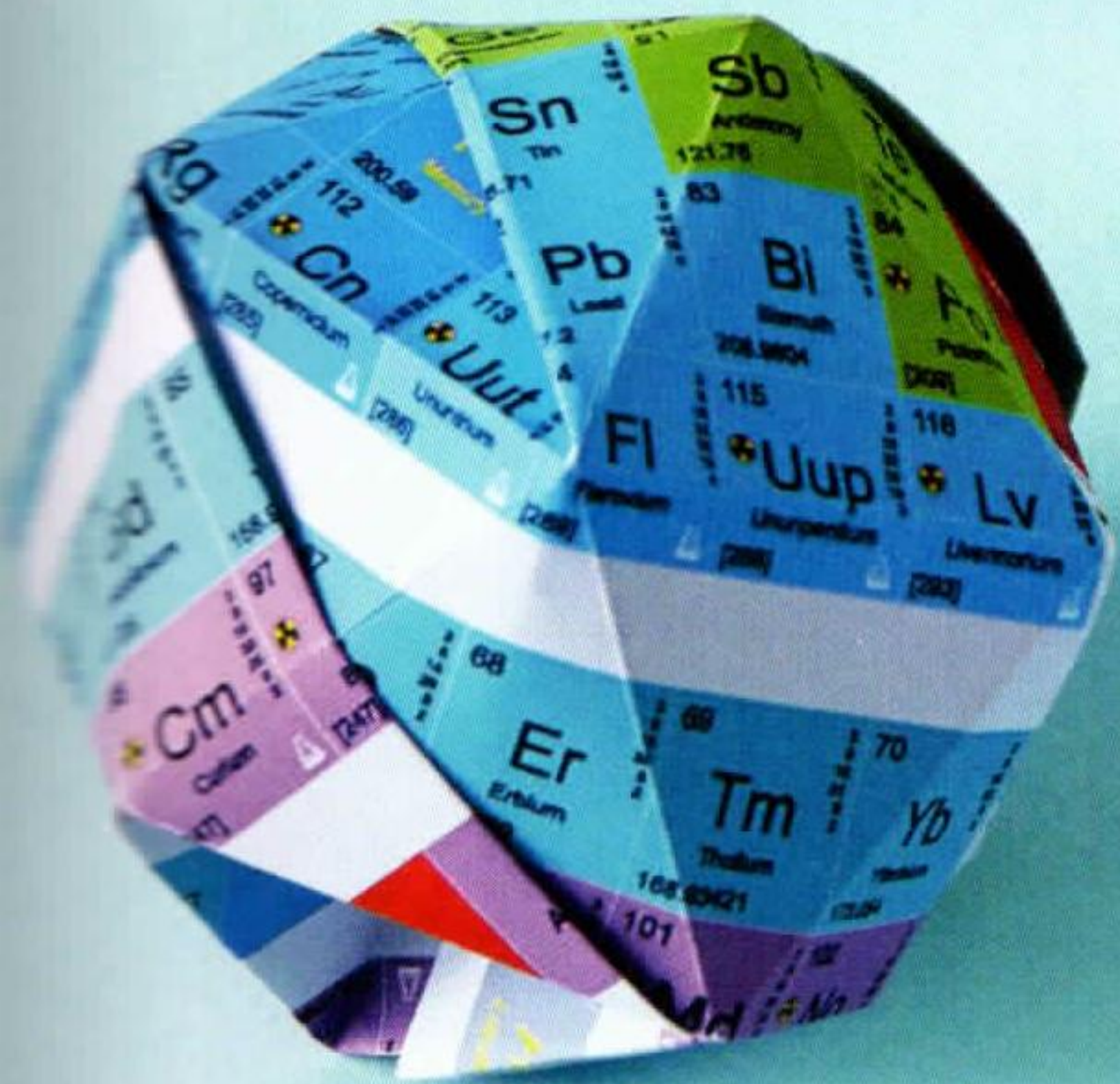
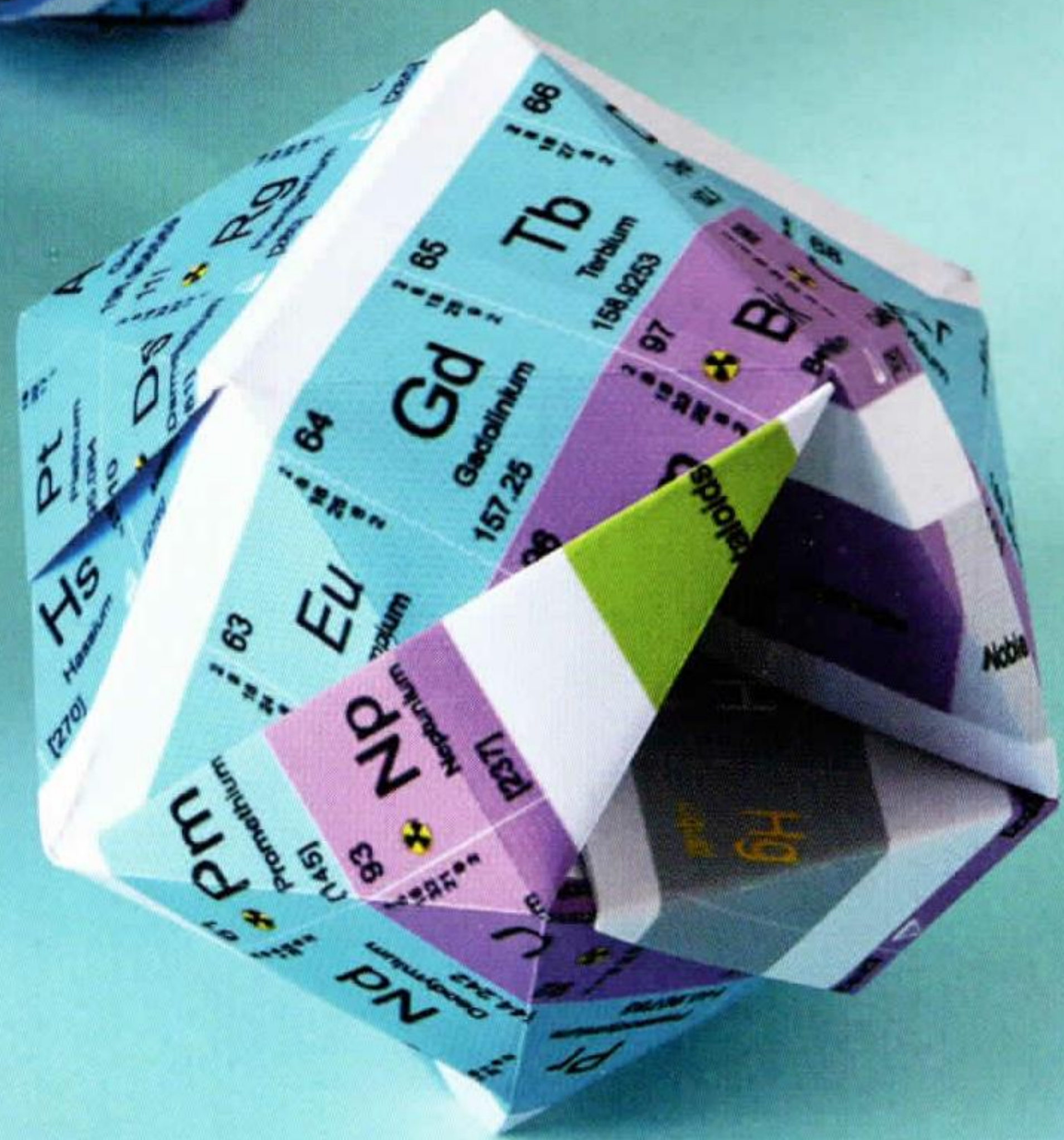
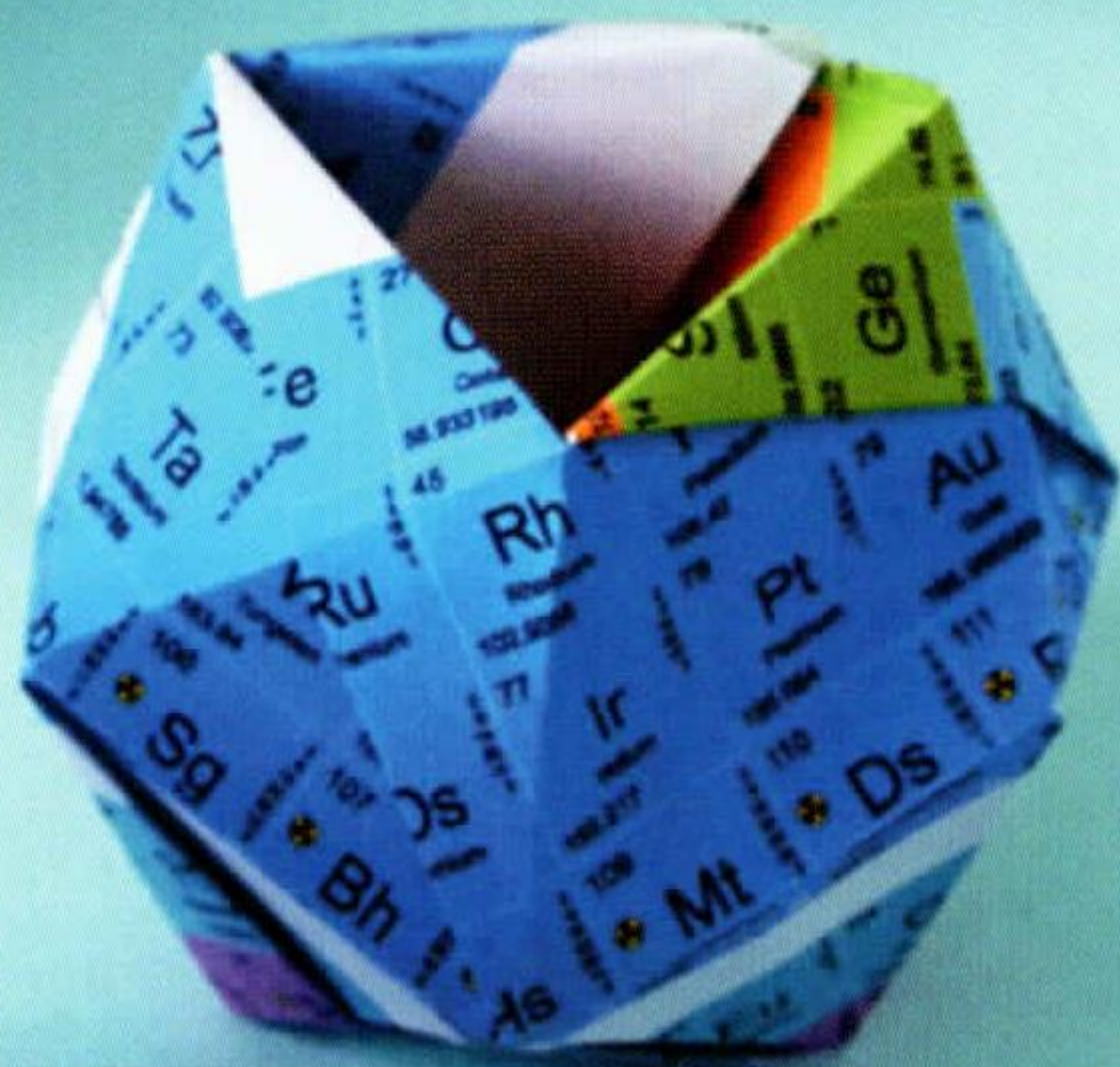
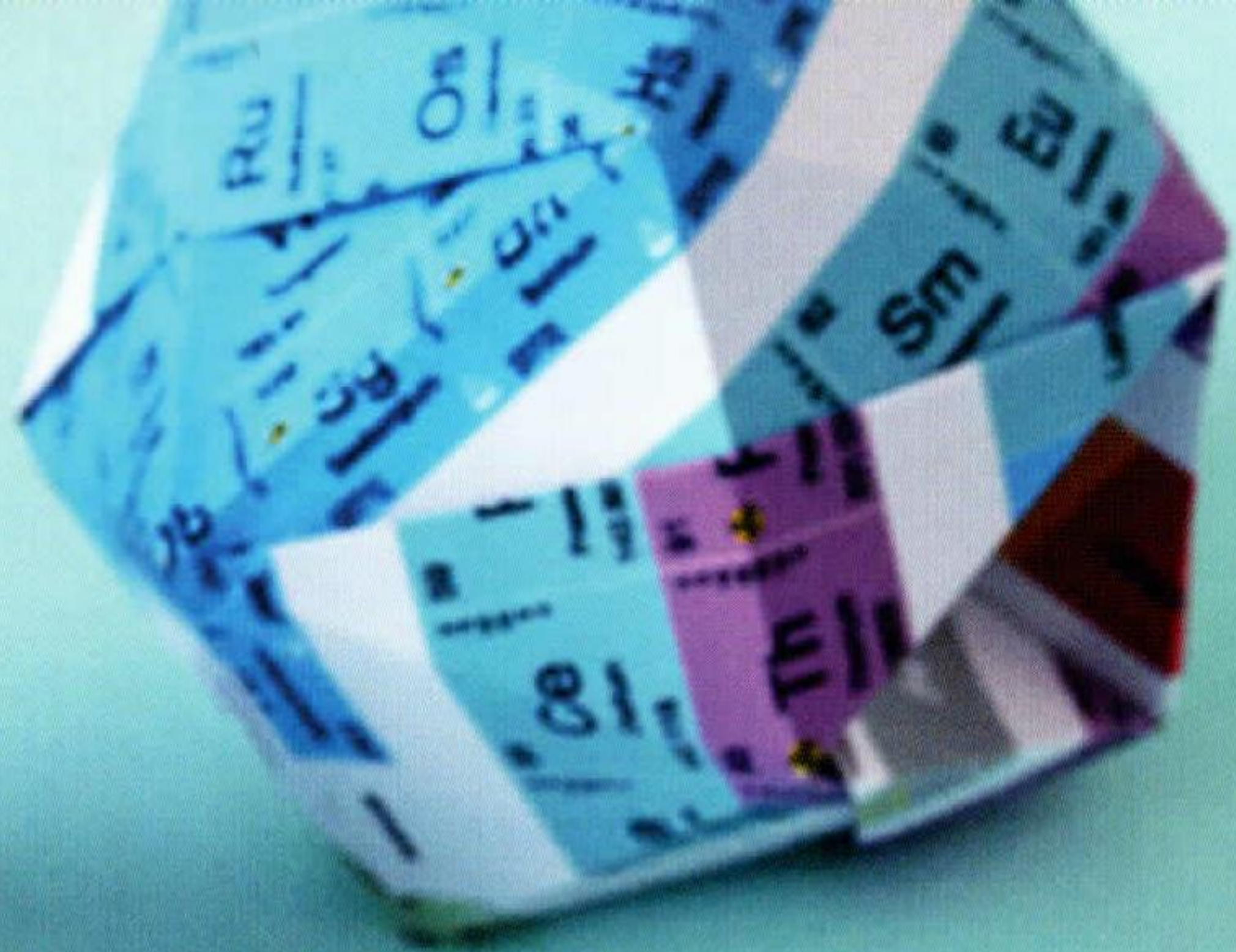
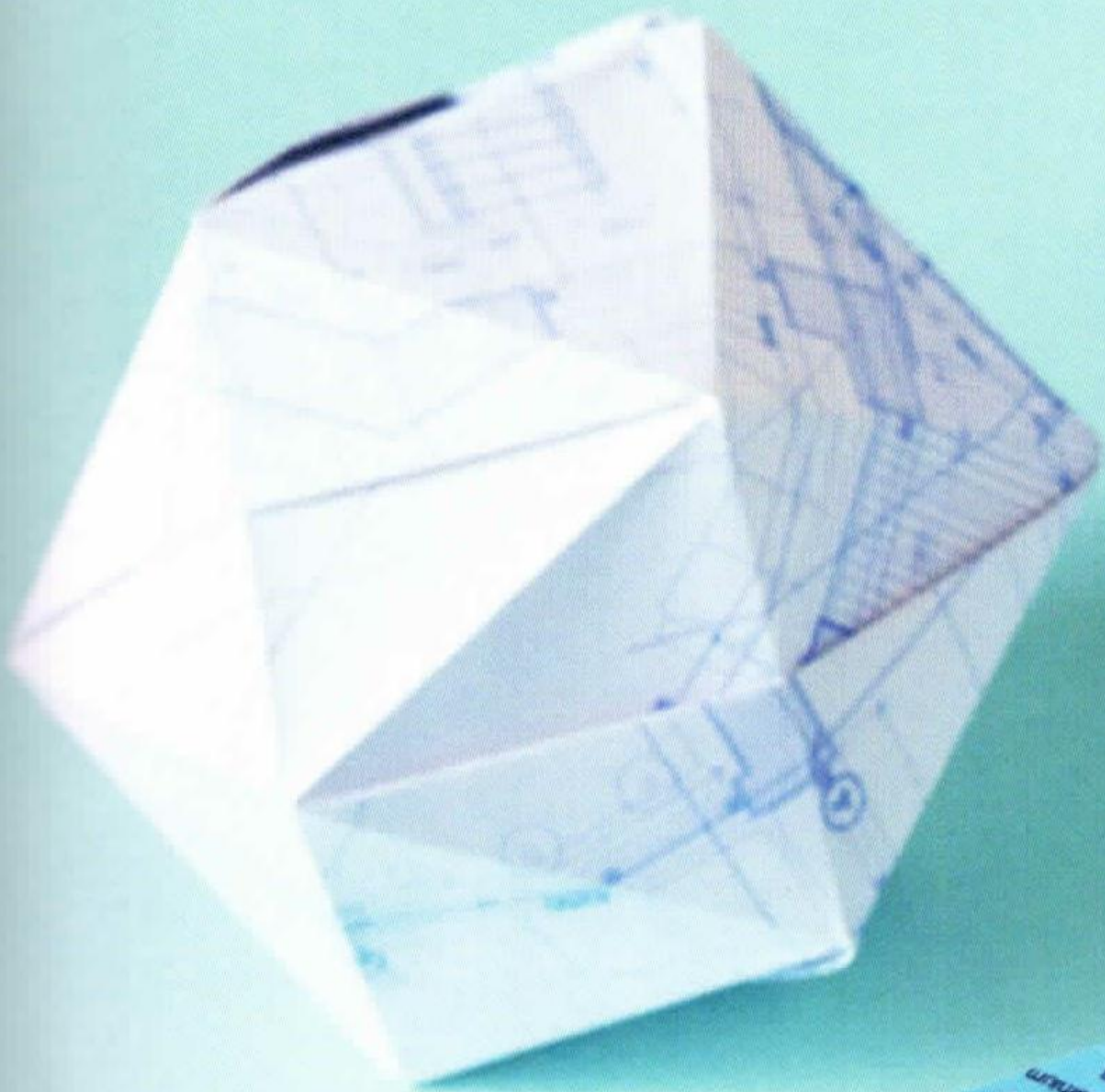

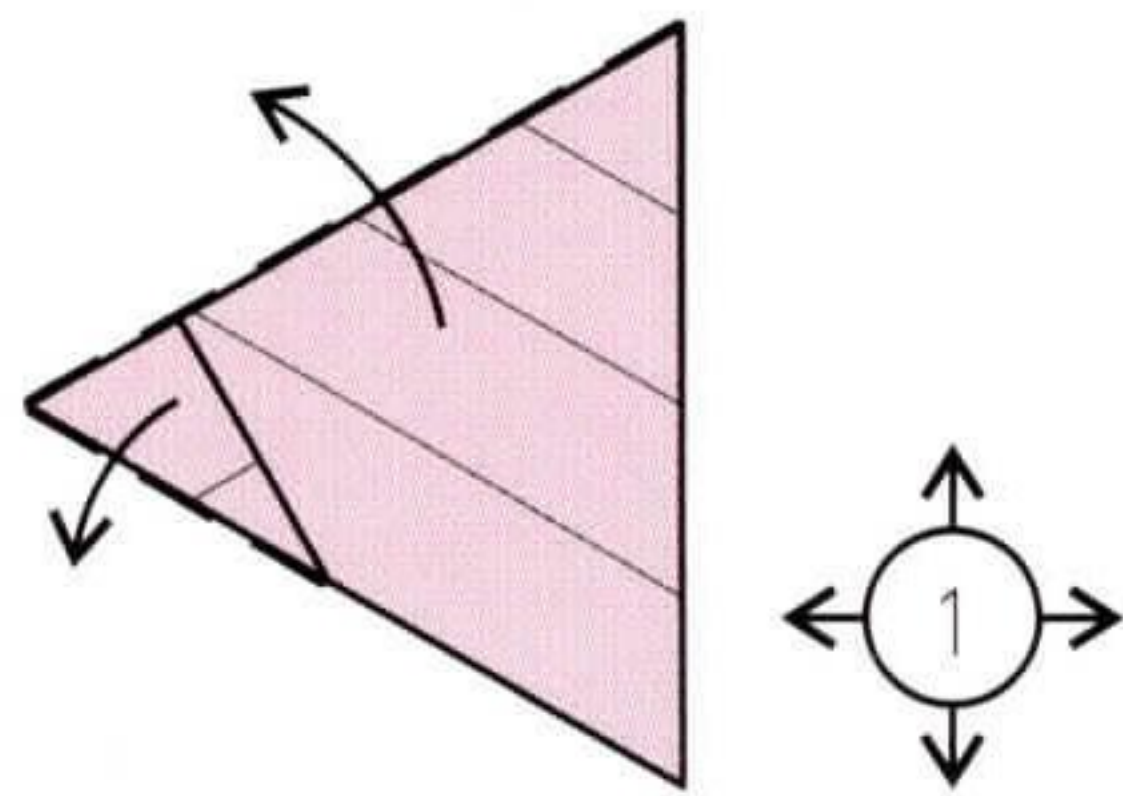

7 Unfold back to the starting rectangle.

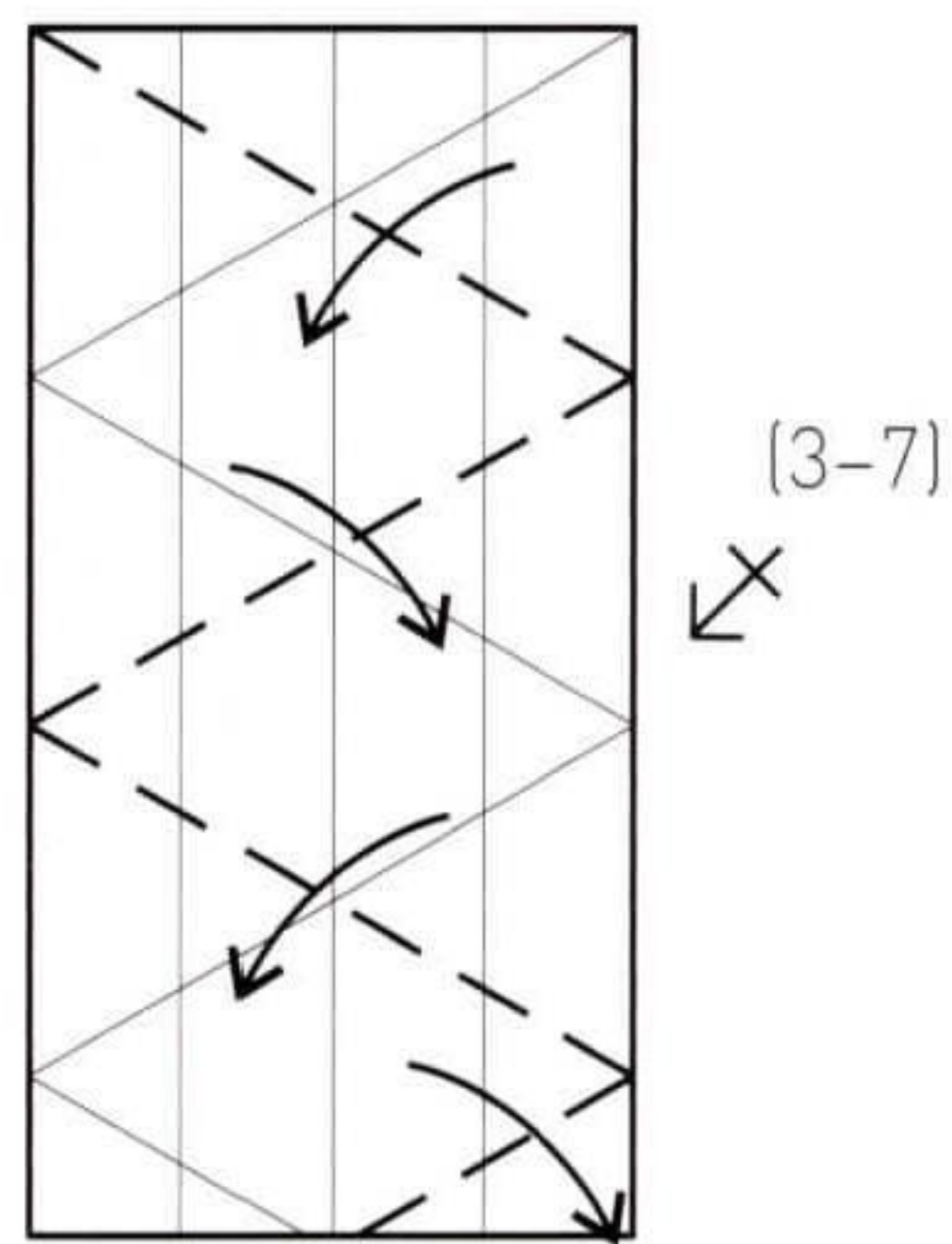

8 Repeat steps 3 to 7 on the other side. This will mirror the creases made previously.

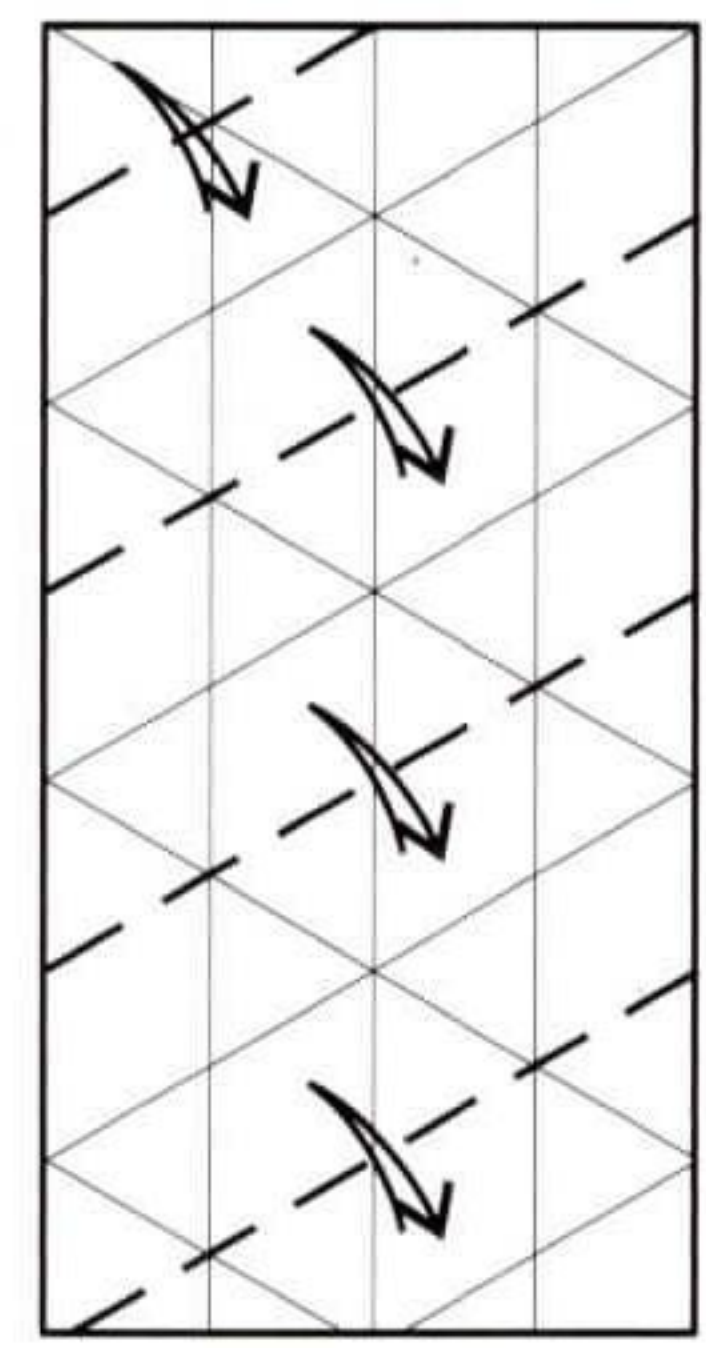

9 Fold and unfold between the parallel diagonal creases.

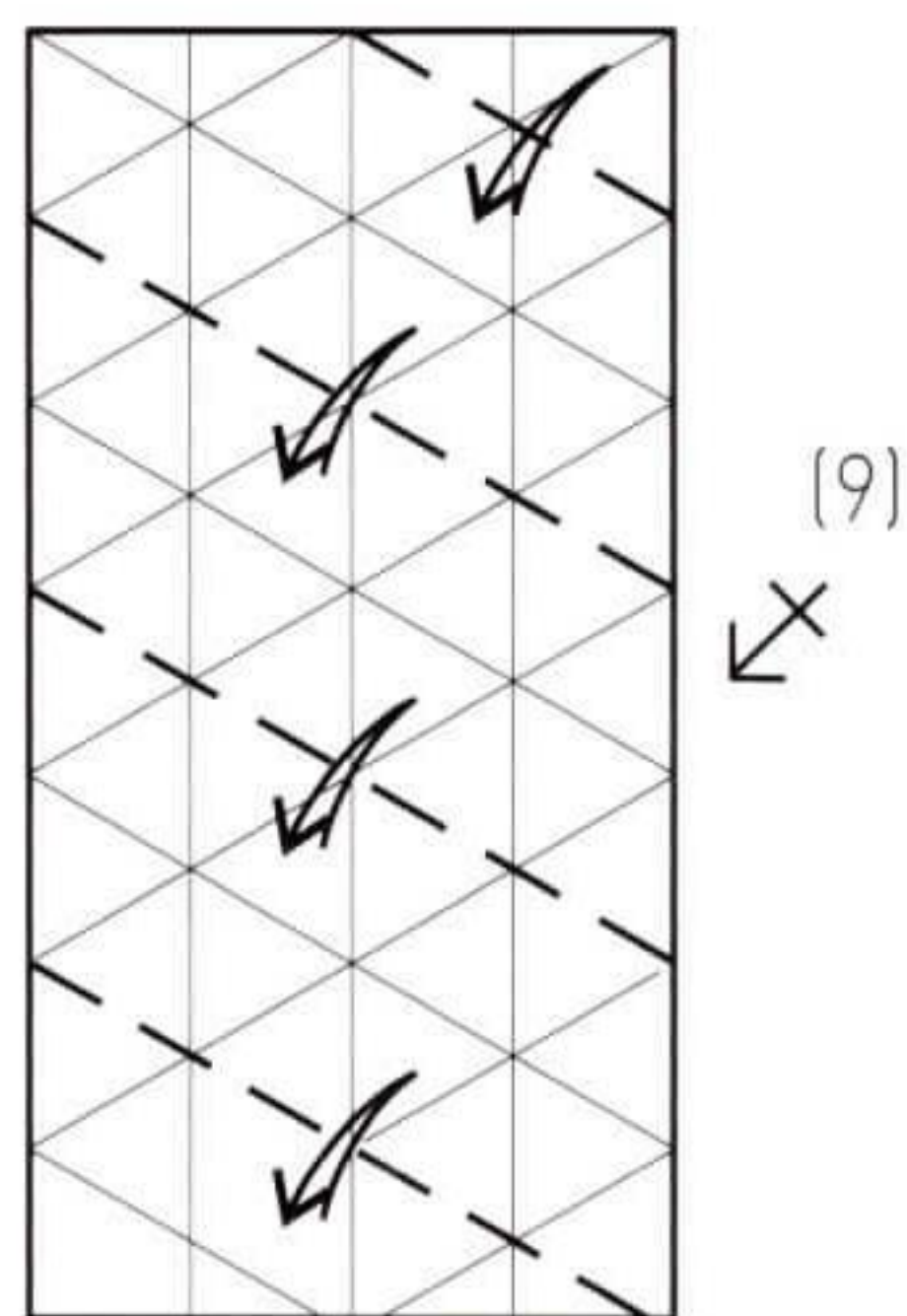

10 Fold and unfold between the parallel creases. This will mirror the previous step.

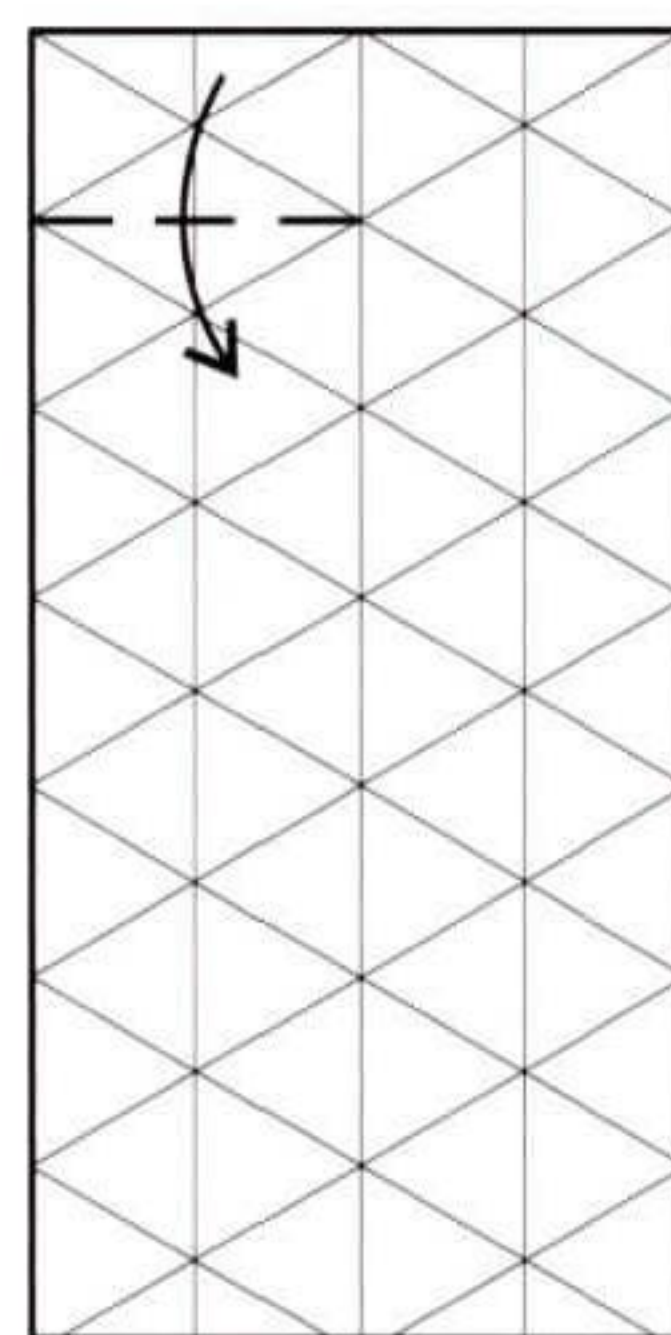

11 Fold the upper edge down at the first intersection of the diagonal creases. This fold should only be on the left side of the paper.

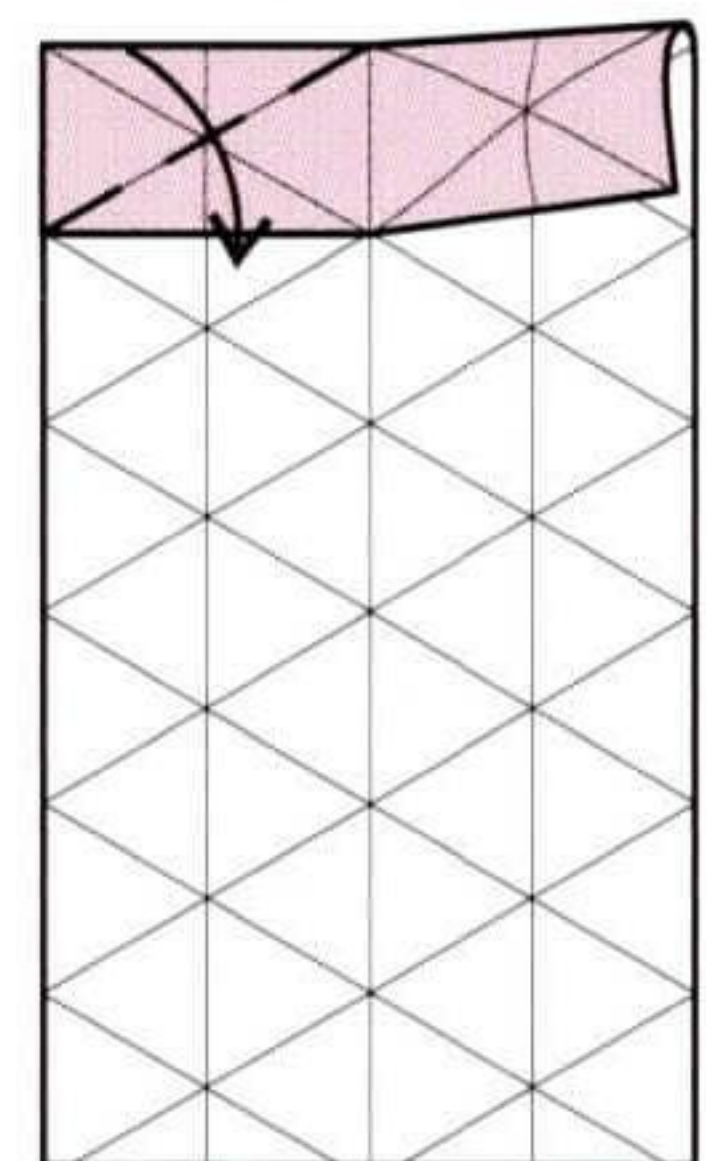

12 Make a diagonal fold in the folded section along the creases made previously.

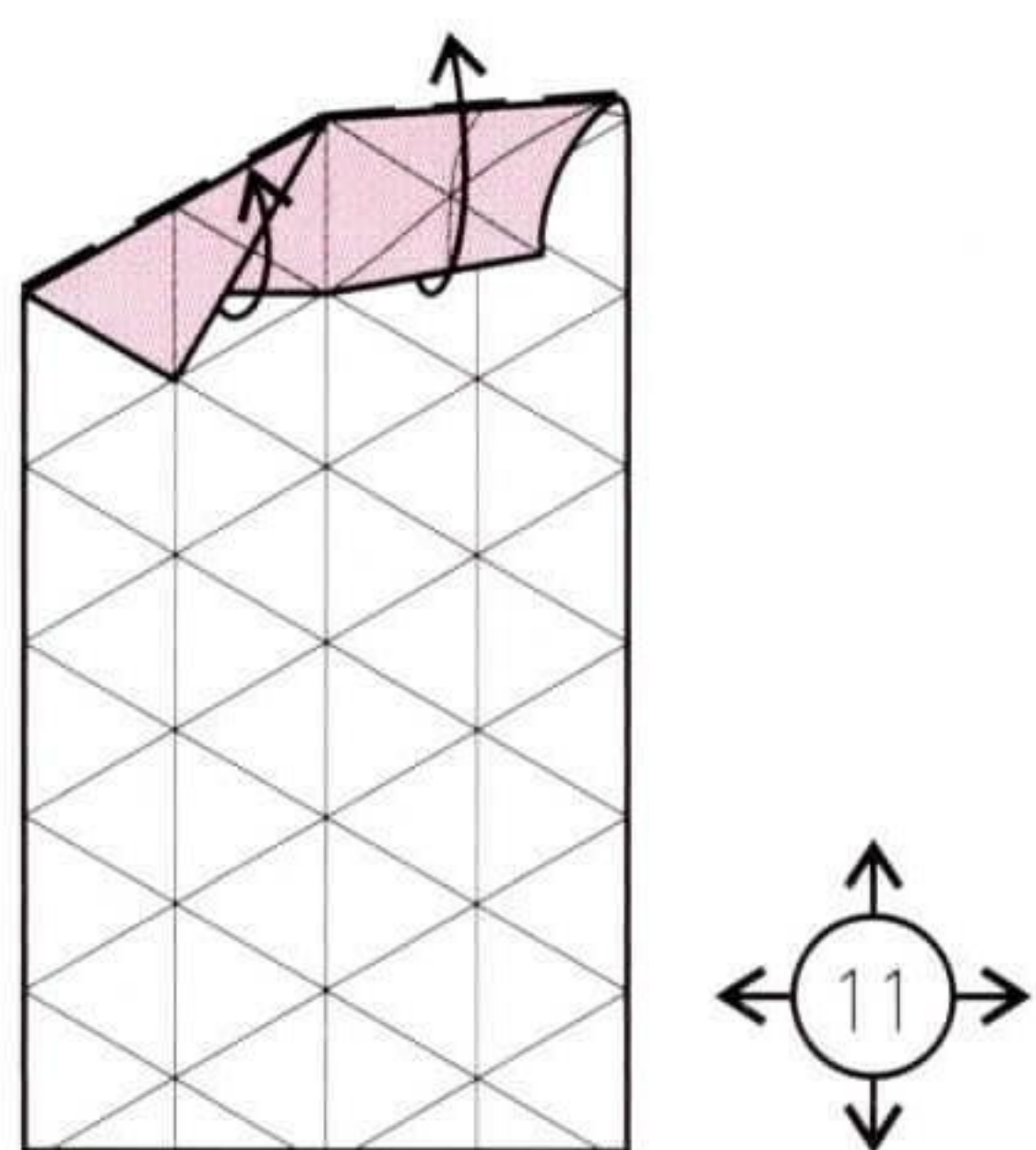

13 Unfold steps 11 and 12.

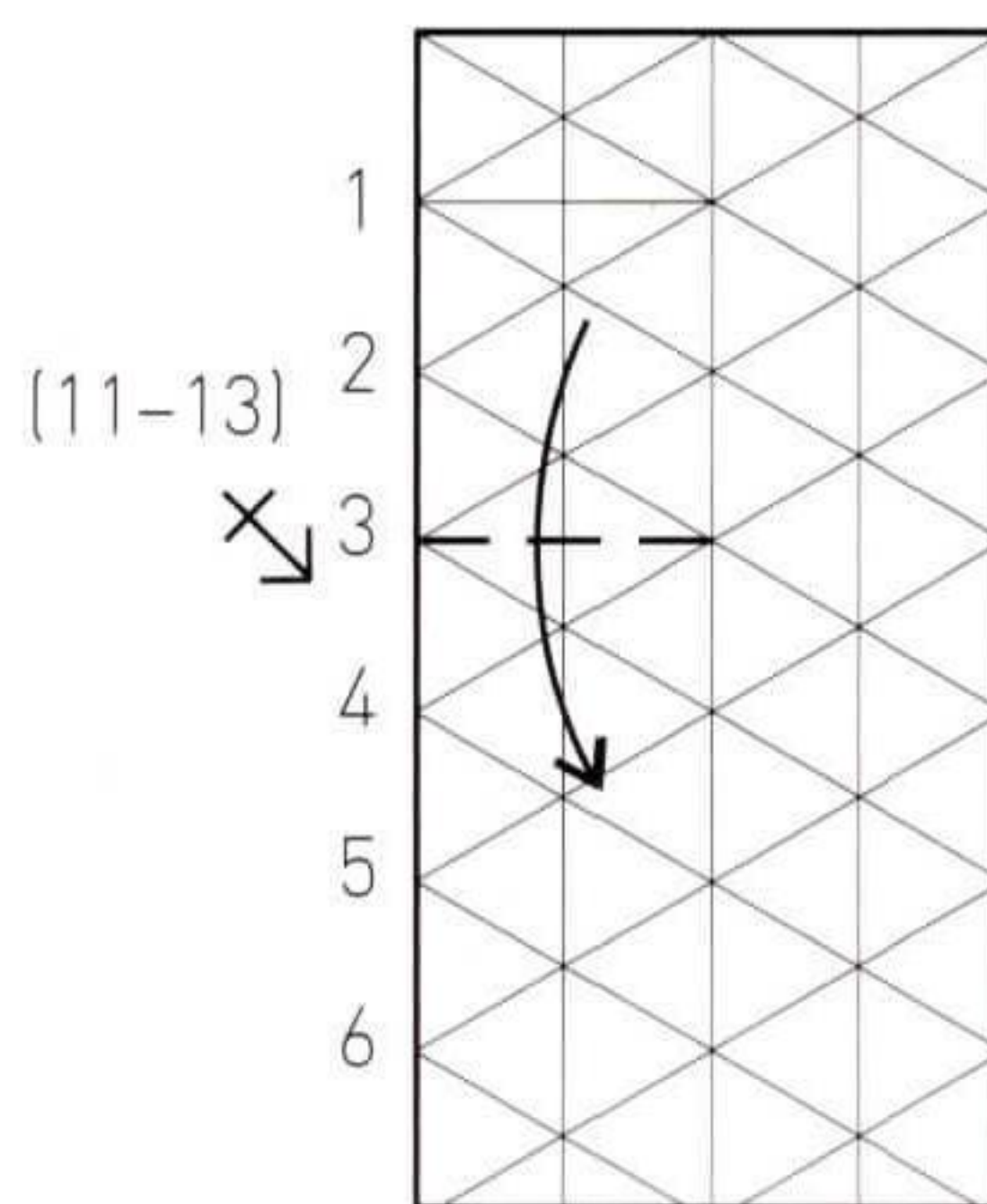

14 Repeat steps 11 to 13 at the third intersection of the diagonal creases.

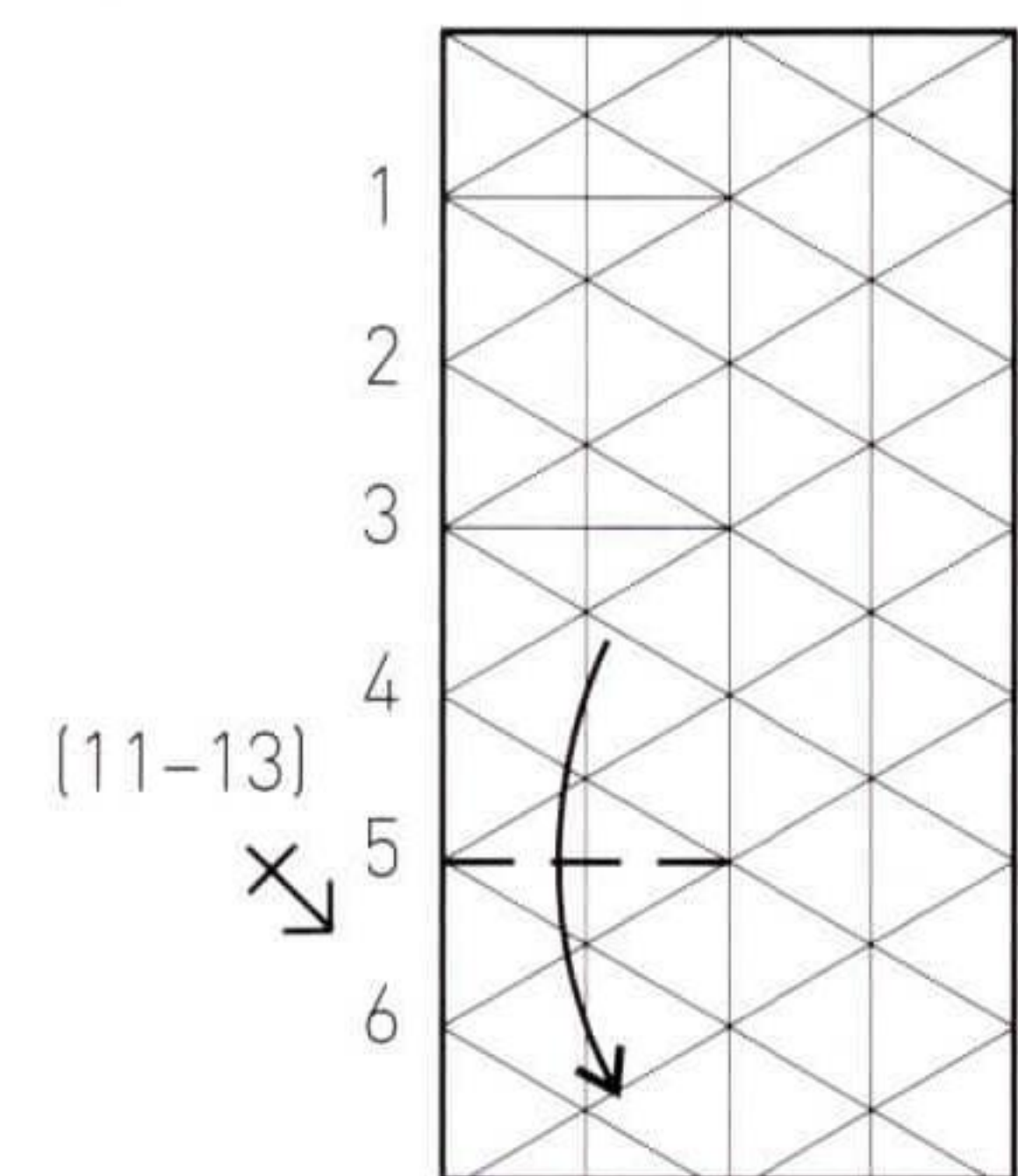

15 Repeat steps 11 to 13 at the fifth intersection of the diagonal creases.

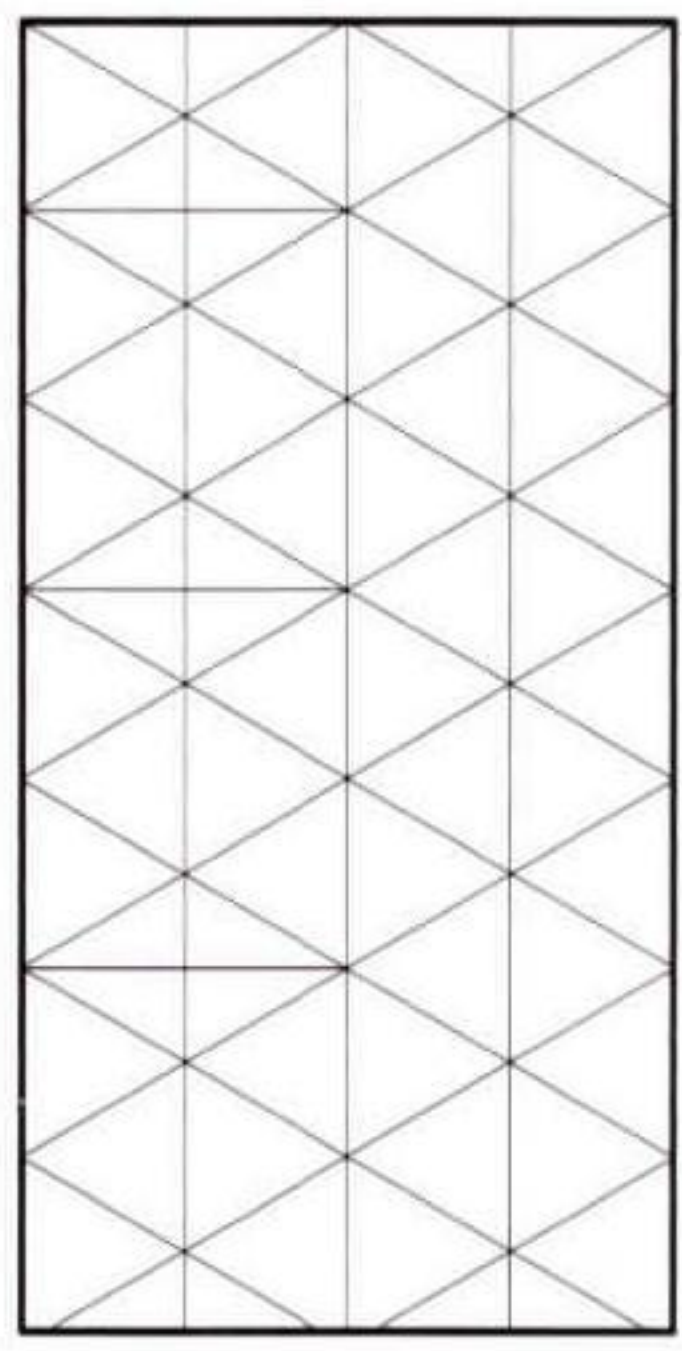

180°

16 Rotate the model by 180°.

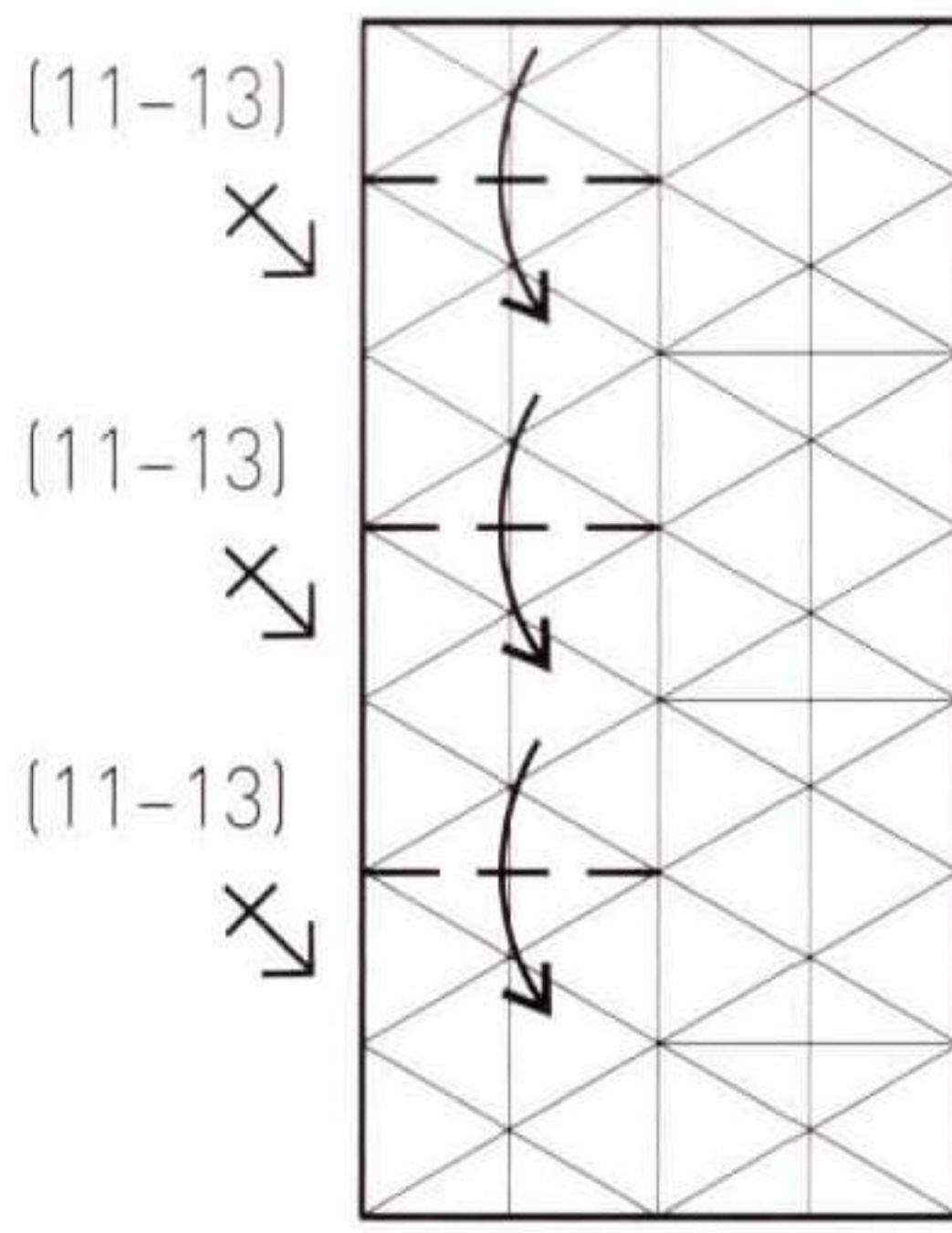

17 Repeat steps 11 to 13 on the first, third and fifth crease intersections. Note these are not aligned with the creases made on the opposite side.

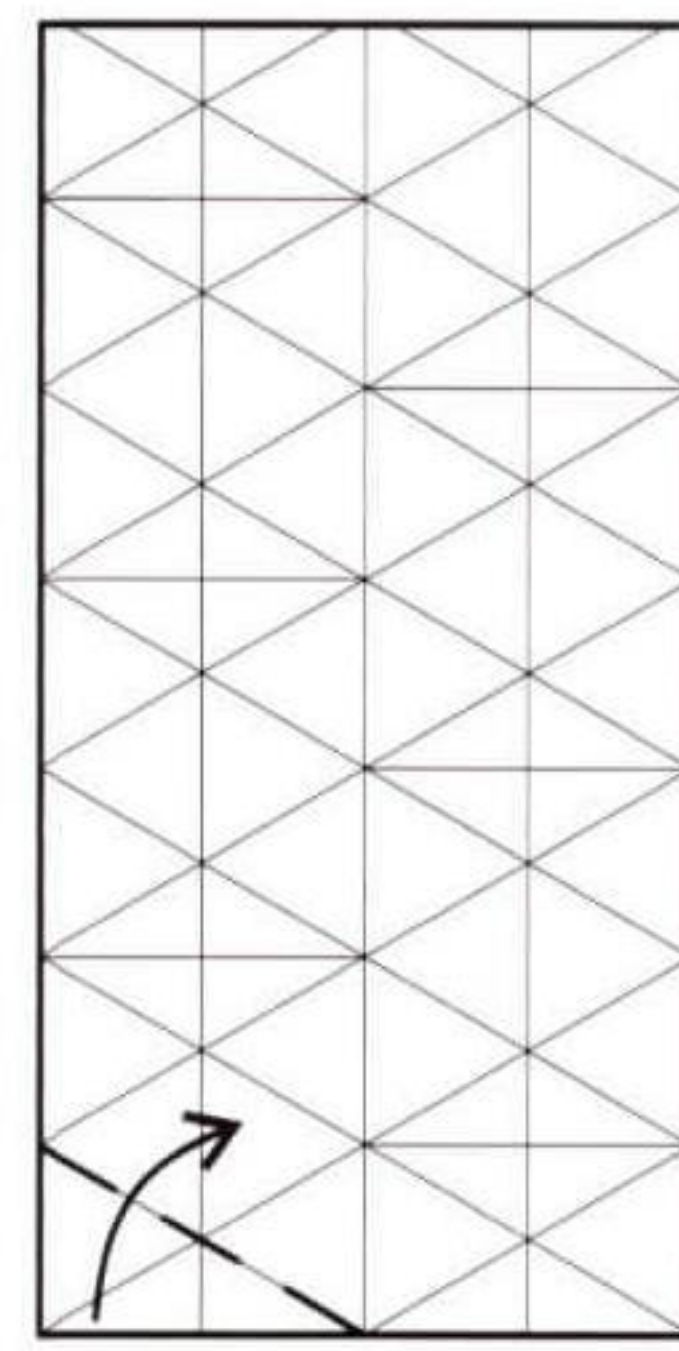

18 Fold the lower left corner up.

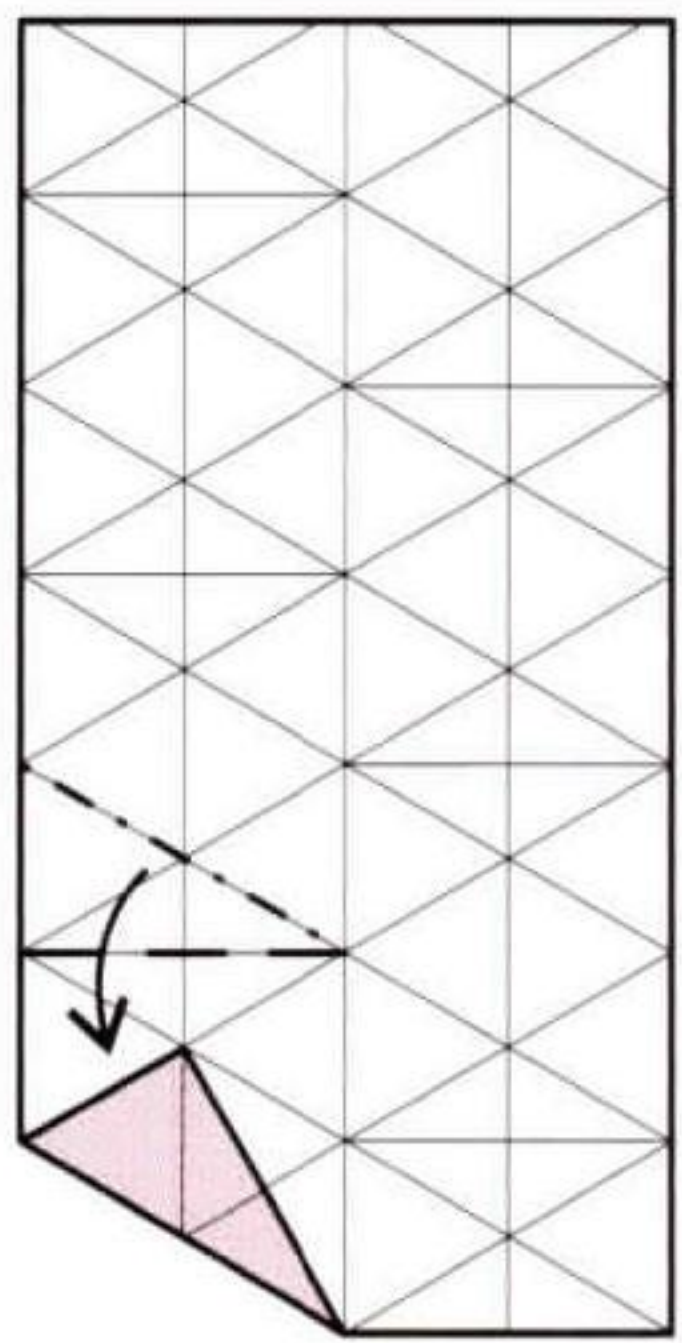

19 Fold the paper above the corner over and back again along the creases made previously in the paper.

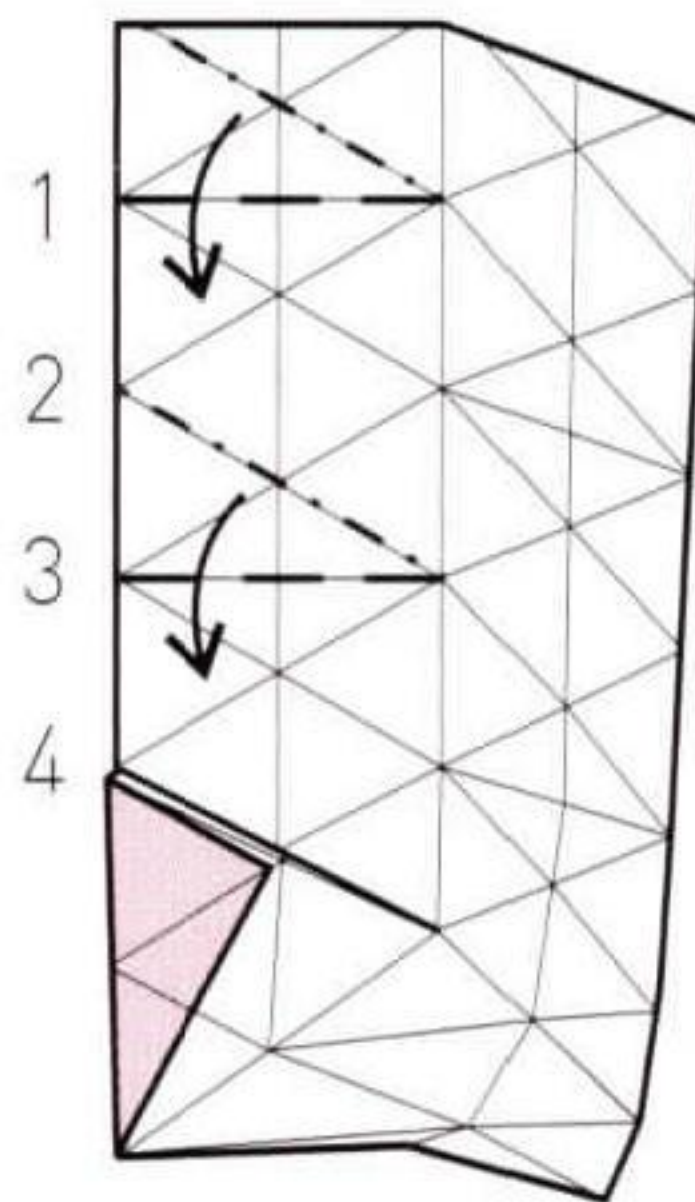

20 Repeat the folding process in step 19 on the creases at the first and third intersections.

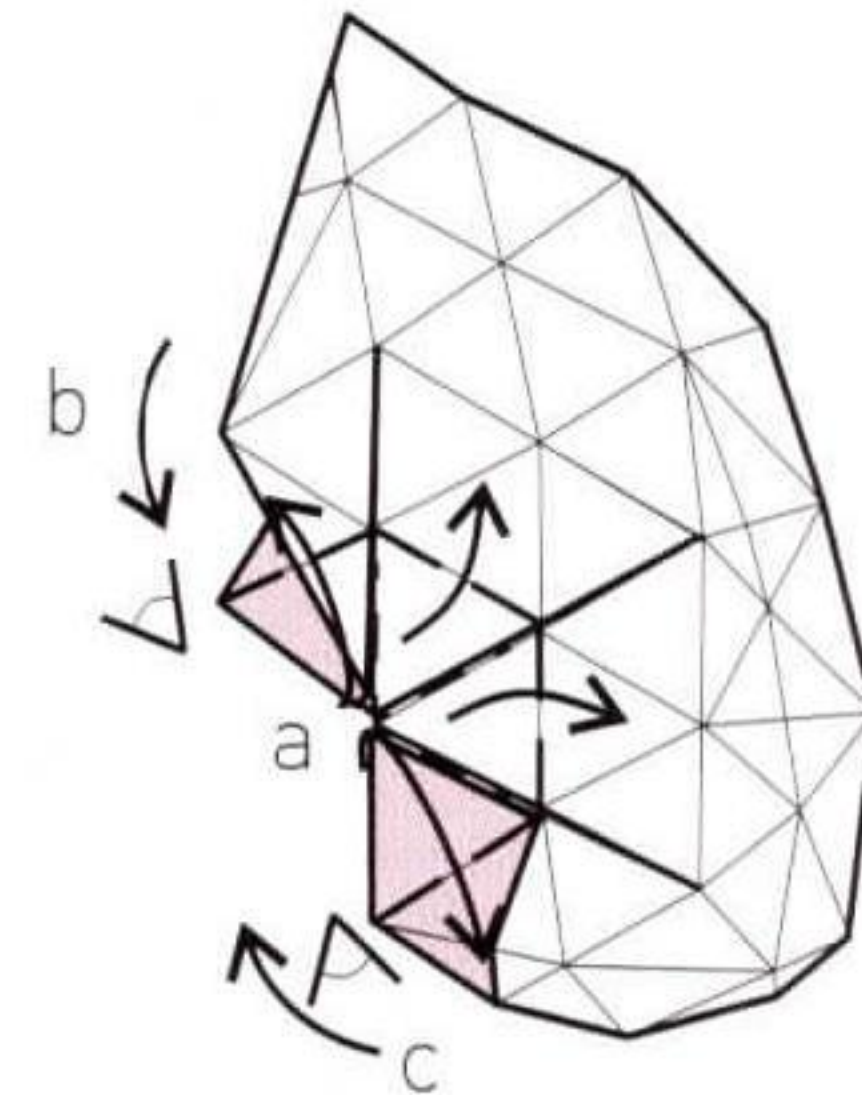

21 Hold all of the folded sections together and fold the inner section (a) in. This will bring the sides (b) and (c) together.

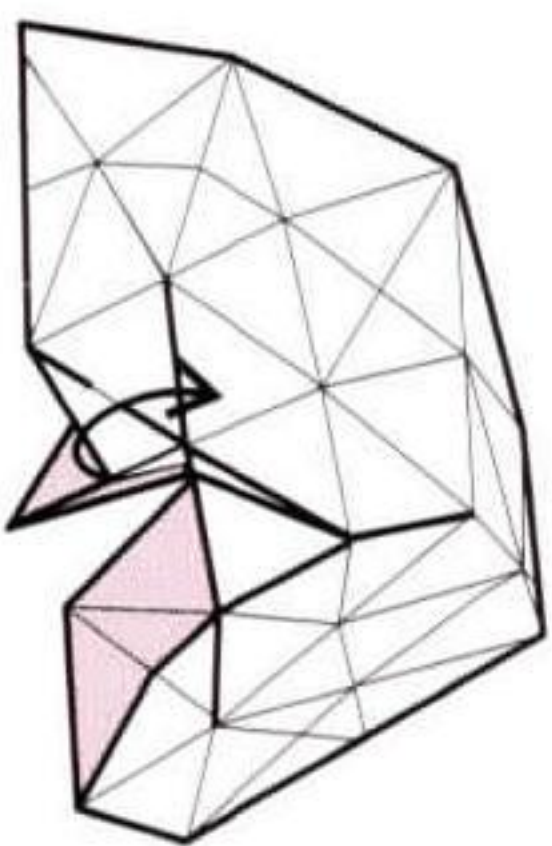

22 Fold the edge over and in to the model.

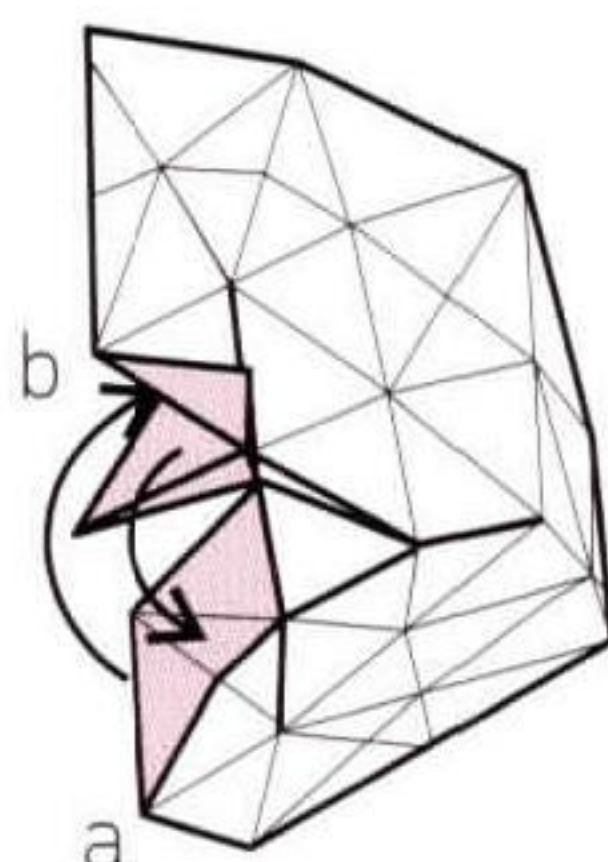

23 Fold the corner (a) into the space (b).

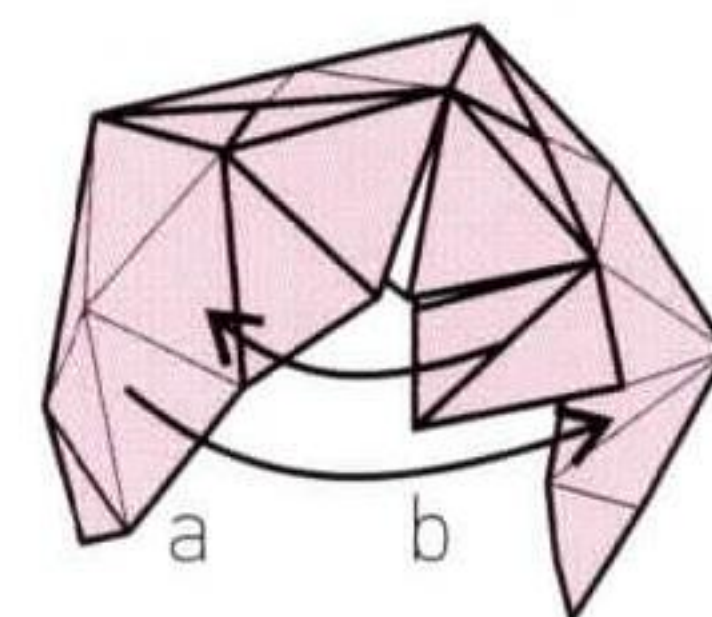

24 This shows a view of the fold from the upper side. The folded corner (a) is folding over (b) to form an inverted pyramid made of three equilateral triangles.

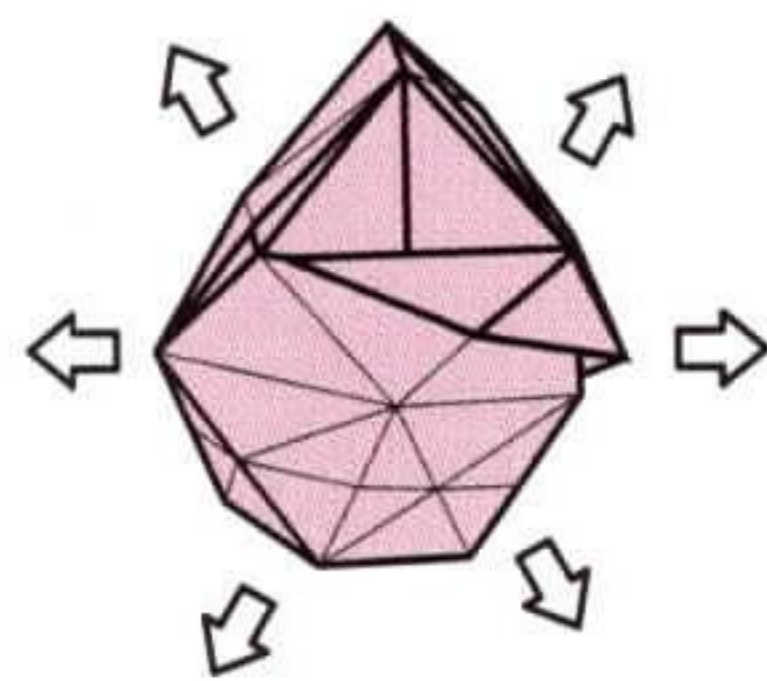

25 This shows one edge wrapped together. Next, unfold back to the starting rectangle.

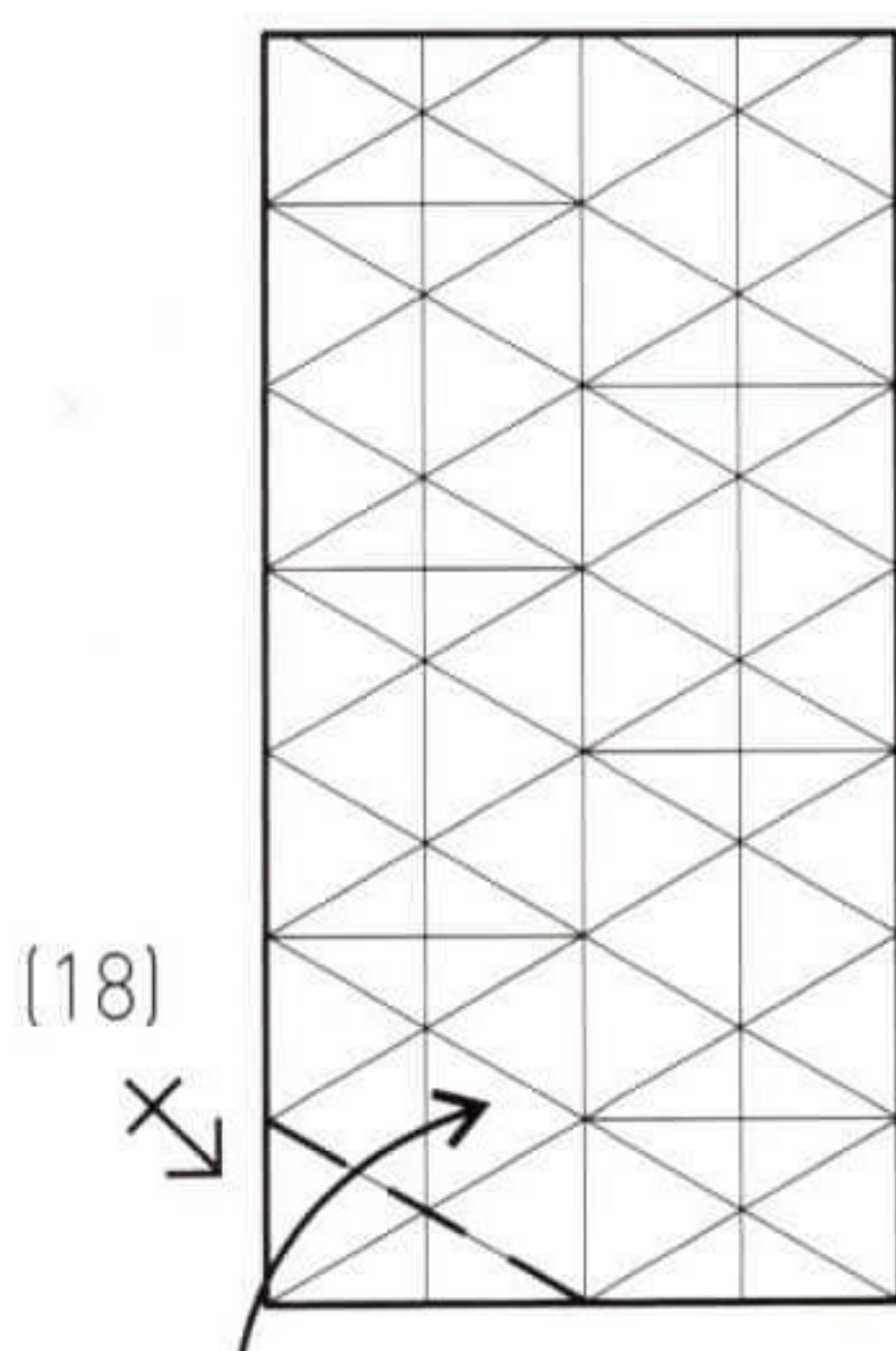

26 Fold the lower corner in, repeating step 18.

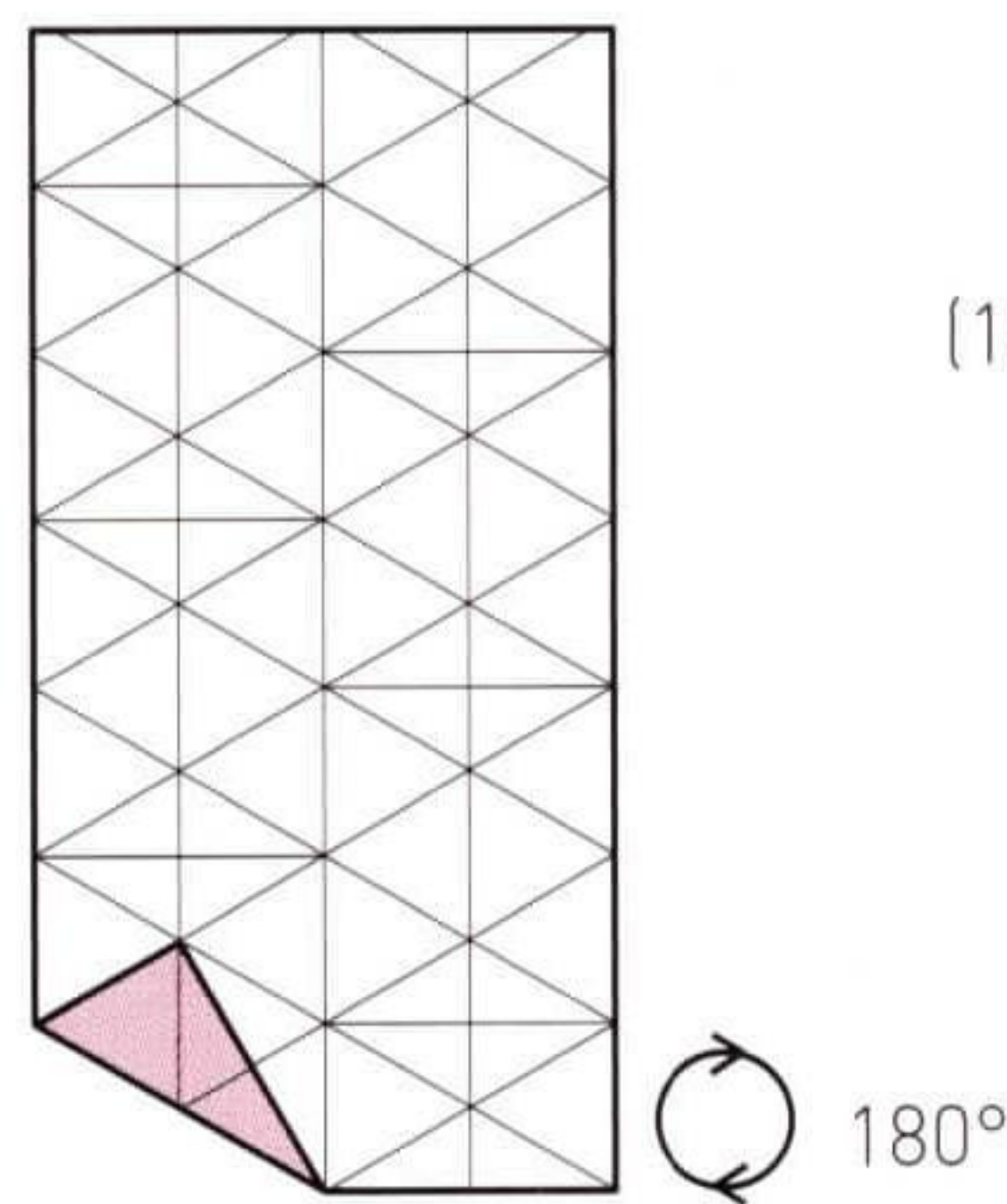

27 Rotate the model by 180°.

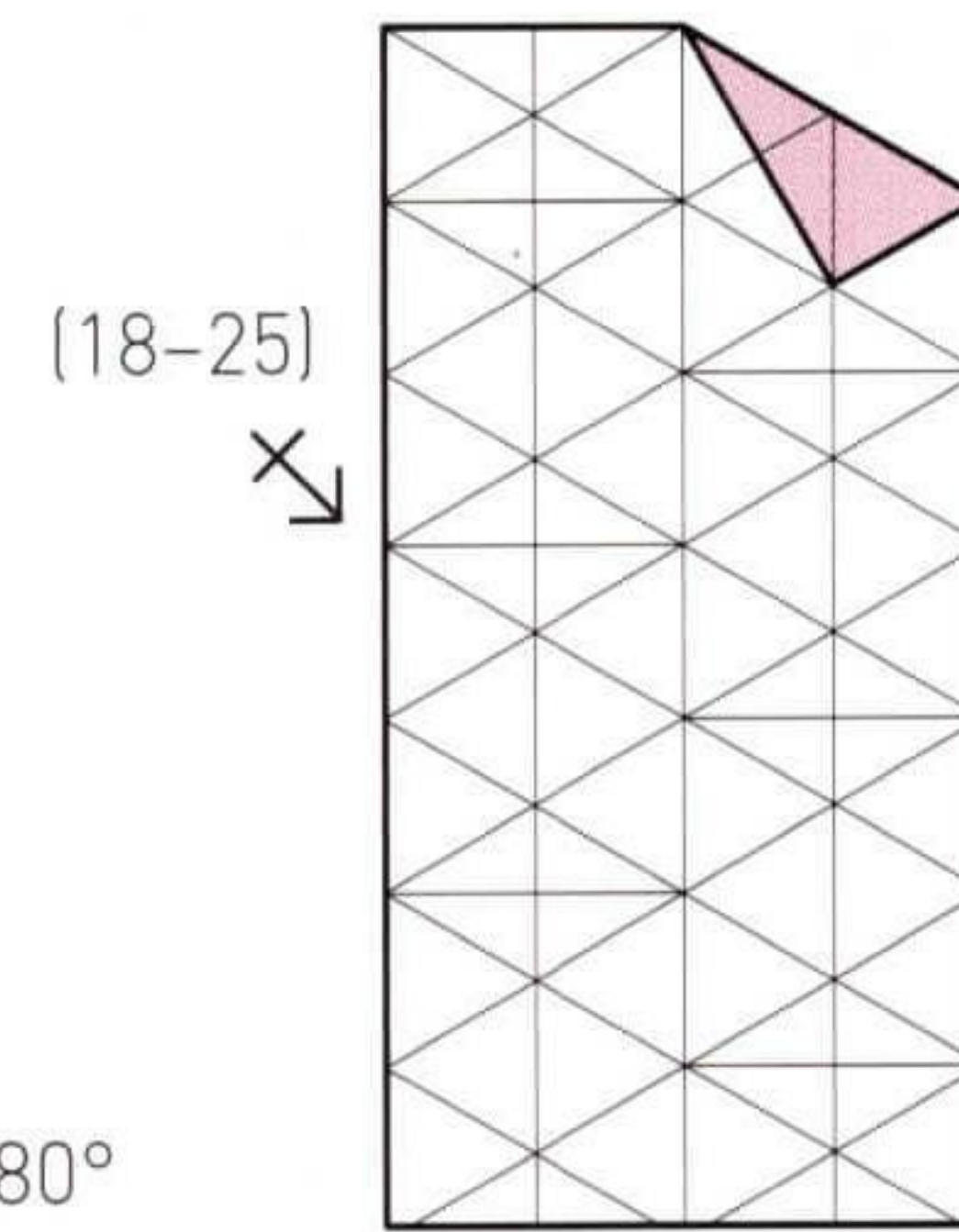

28 Repeat steps 18 to 25 to fold and roll up the edge of the paper.

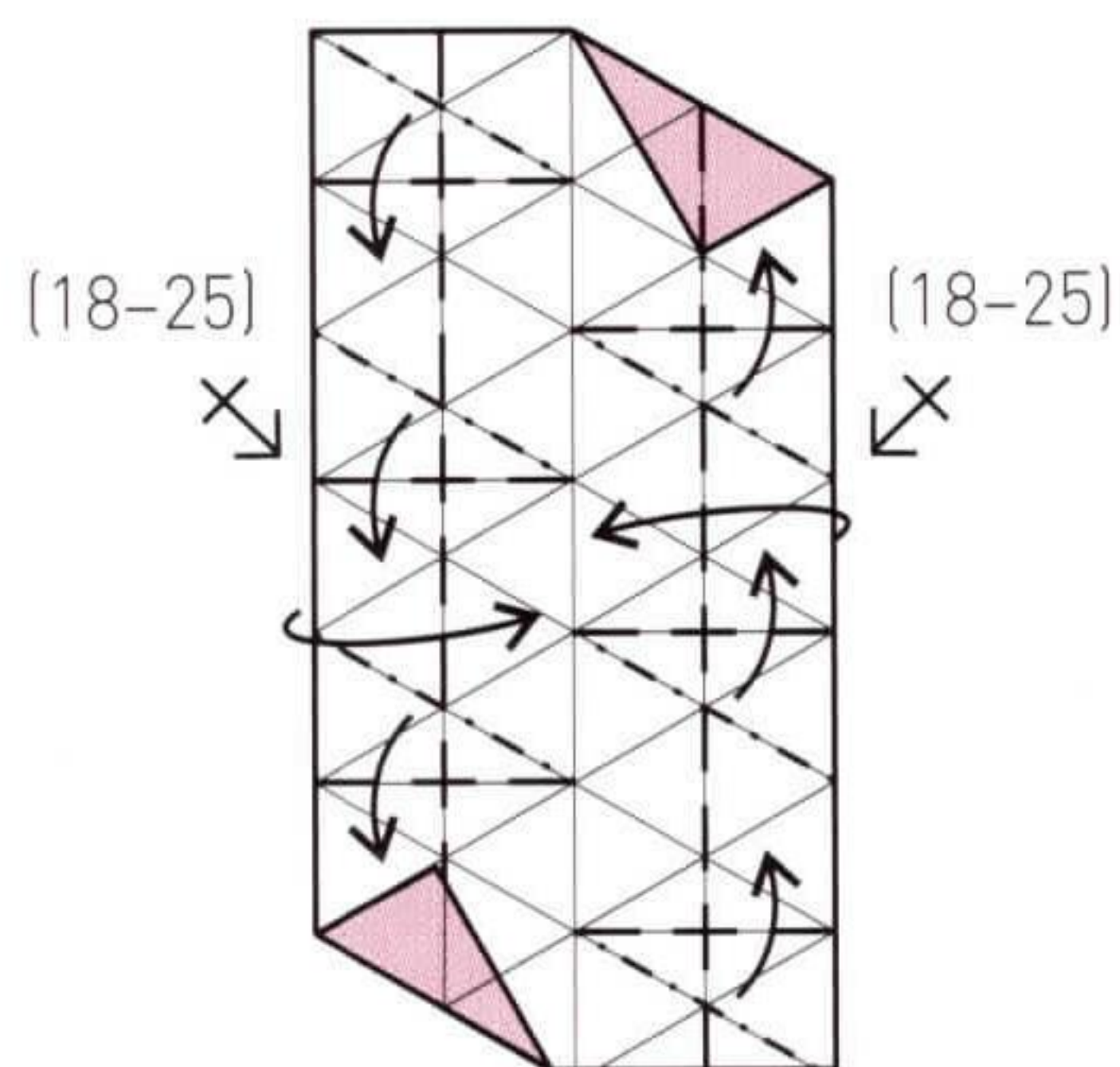

29 Now refold both edges of the rectangle at the same time, using the creases made previously.

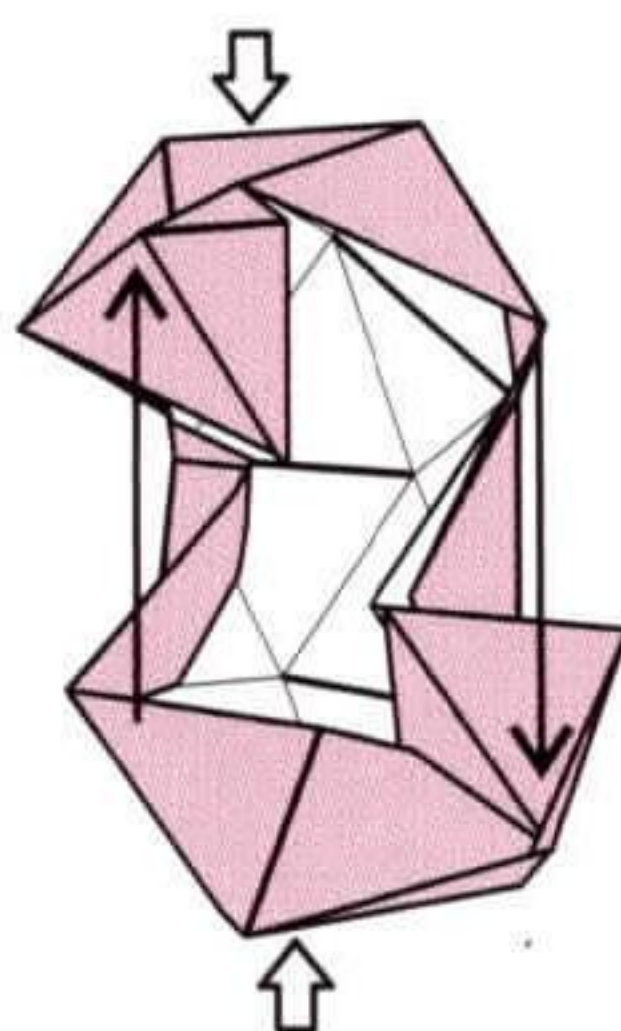

30 The model is now a bit twisted. Push the two sides together to tuck one side into the other (see below).

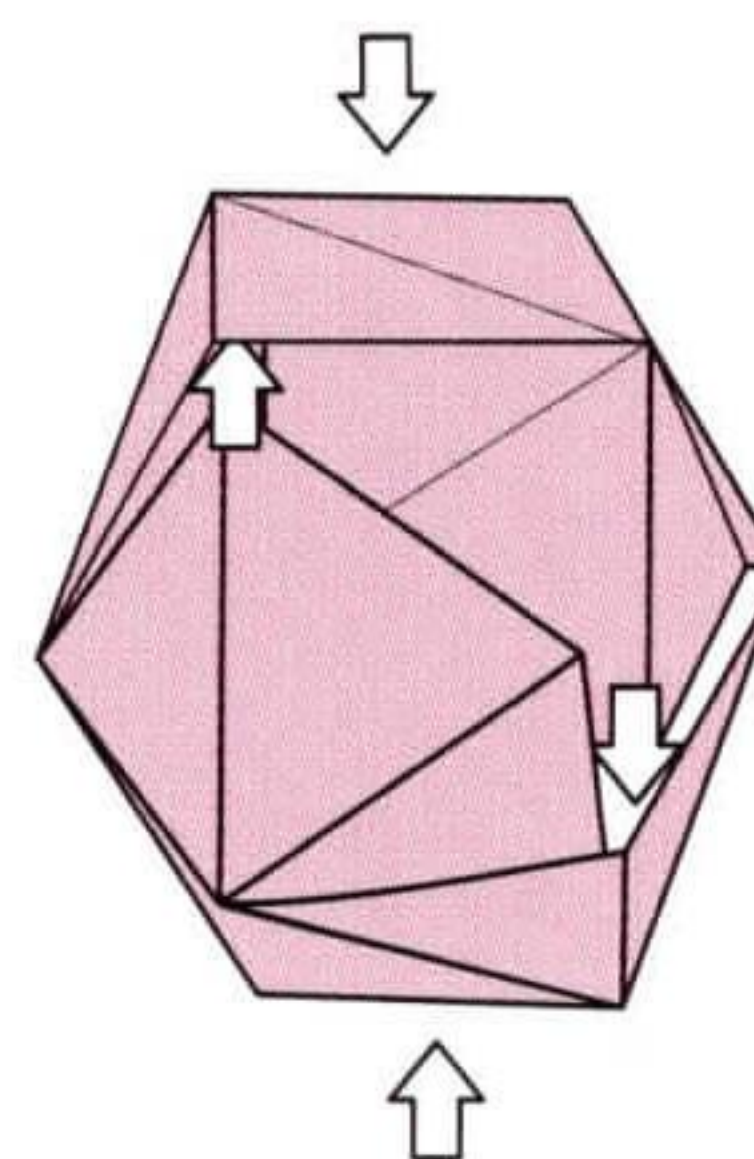

31 The two sides should slide together with the upper section sliding into the lower section.

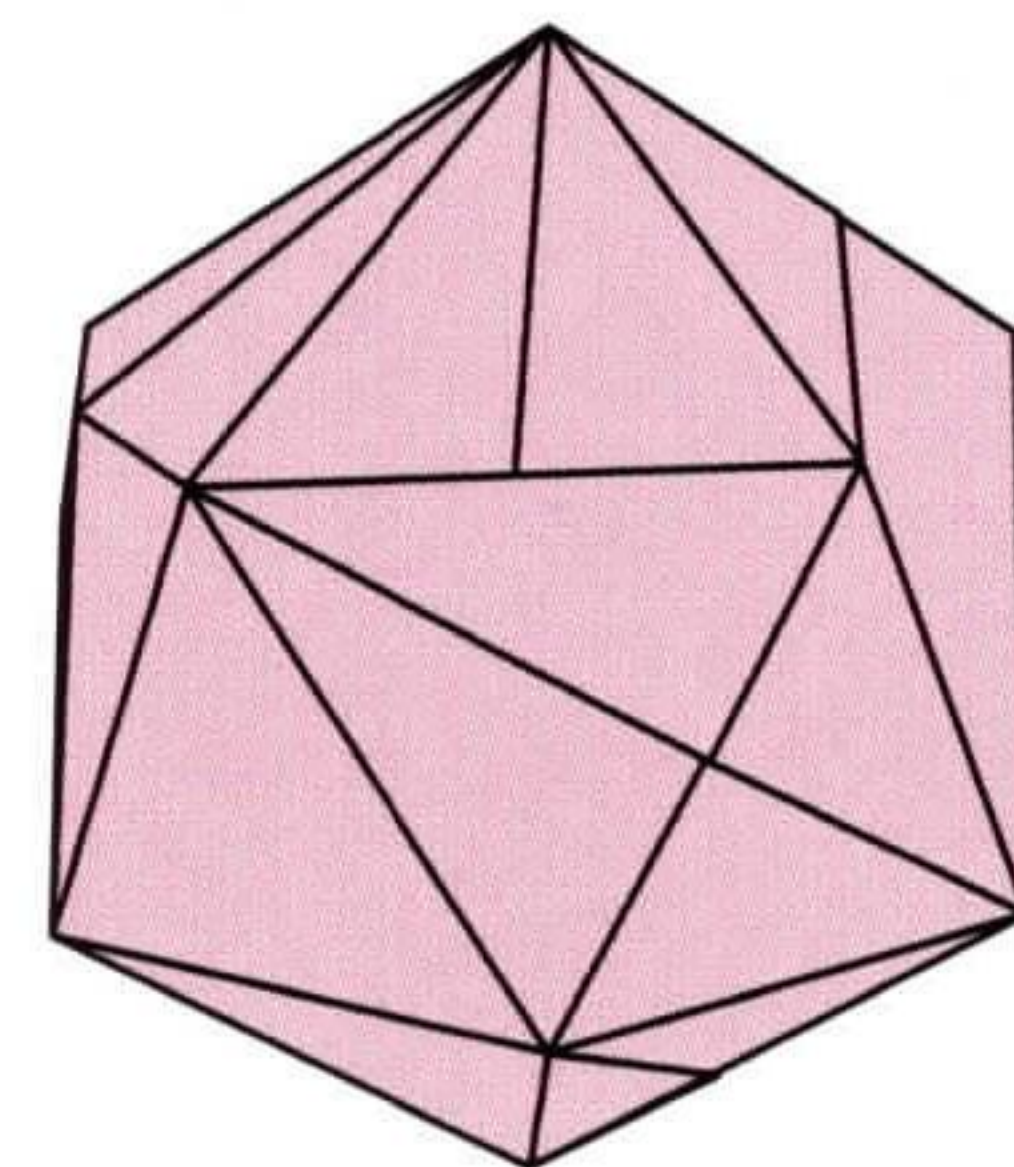

32 The icosahedron should lock together. Rotate it slightly and stand it up.

FINAL ASSEMBLY OF THE ICOSAHEDRON



30a

Hold the folded sides together and line them up.



30b

Open one side slightly and bring the two sides together.



31a

Insert one side into the other. The triangles in each side should align.



31b

Check that you have completed Step 22 with no obstructions, then slide to align.



32

Complete.

Pyramid

*

The pyramid is made by folding the corners of the square into each other to form a pyramid shape. The folding sequence builds an external skin and the final model is made three dimensional by inflating the model.

18 X 18CM (7 X 7IN)

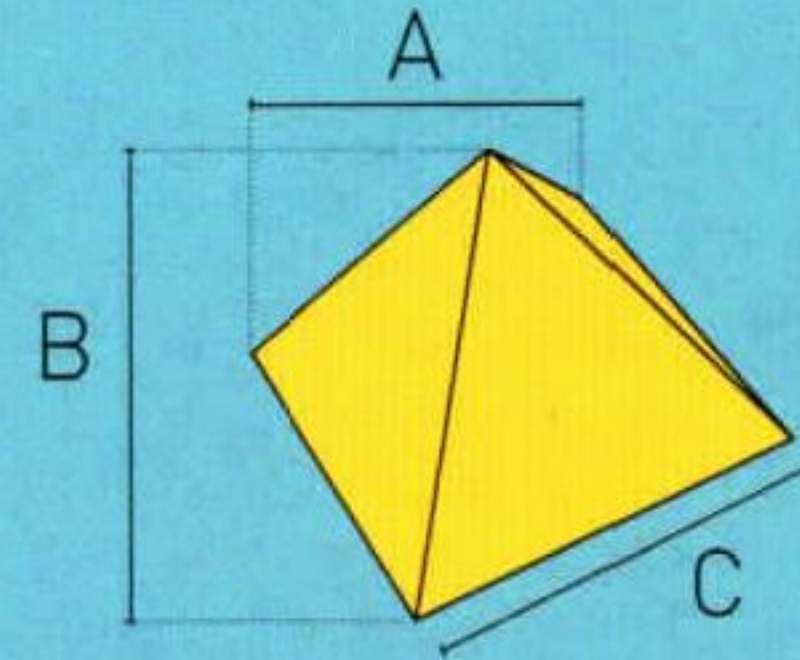
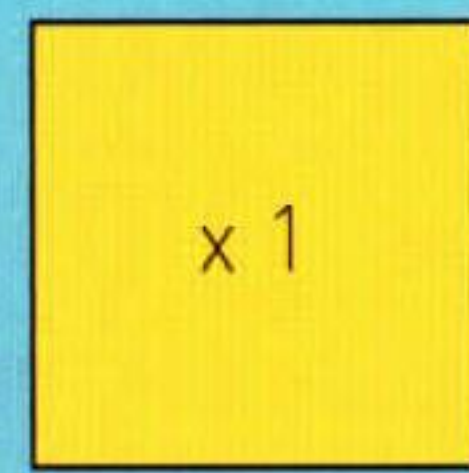

A	6.7cm	(2½in)
B	5.5cm	(2in)
C	6.7cm	(2½in)

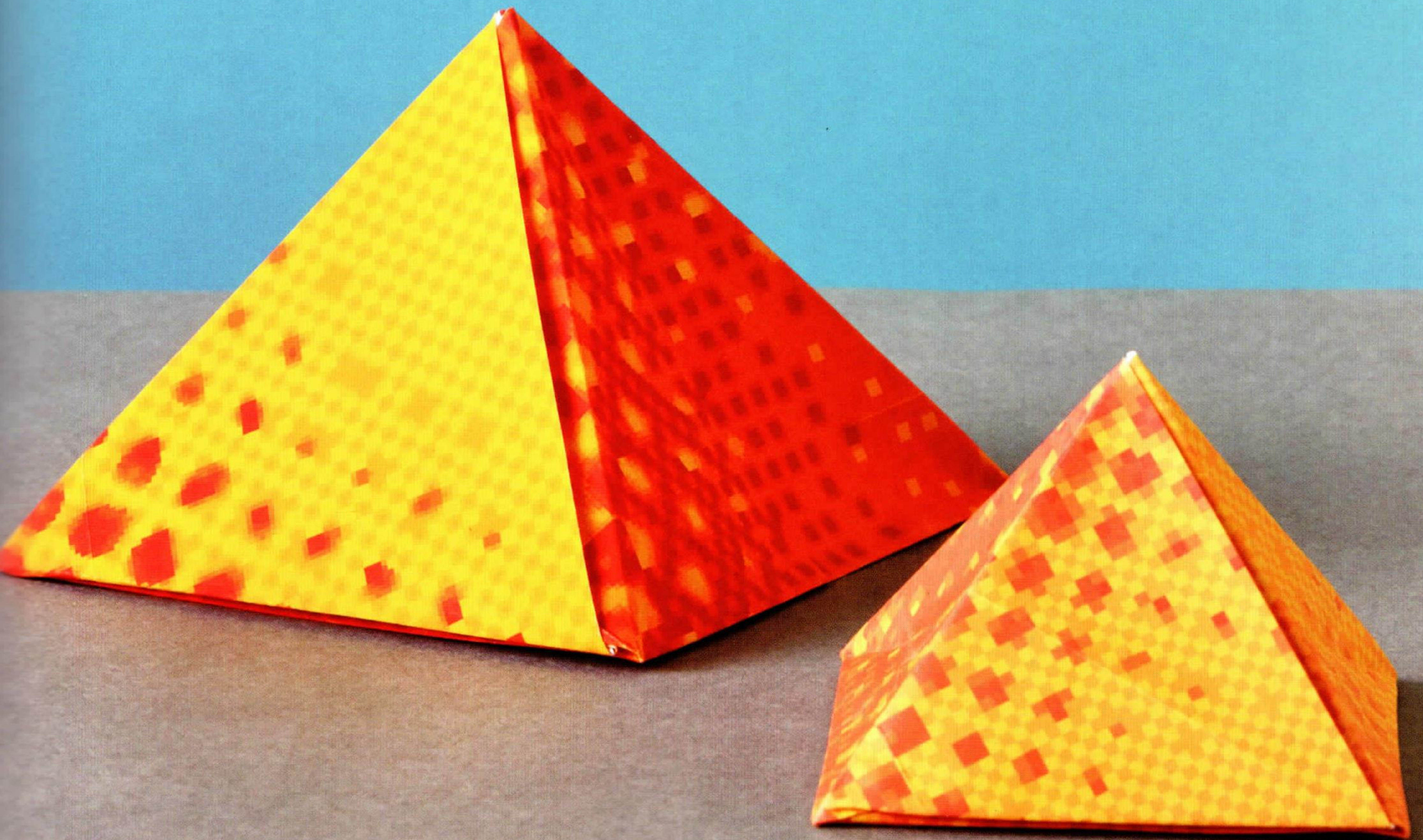

START WITH A SQUARE, COLOURED SIDE UP.

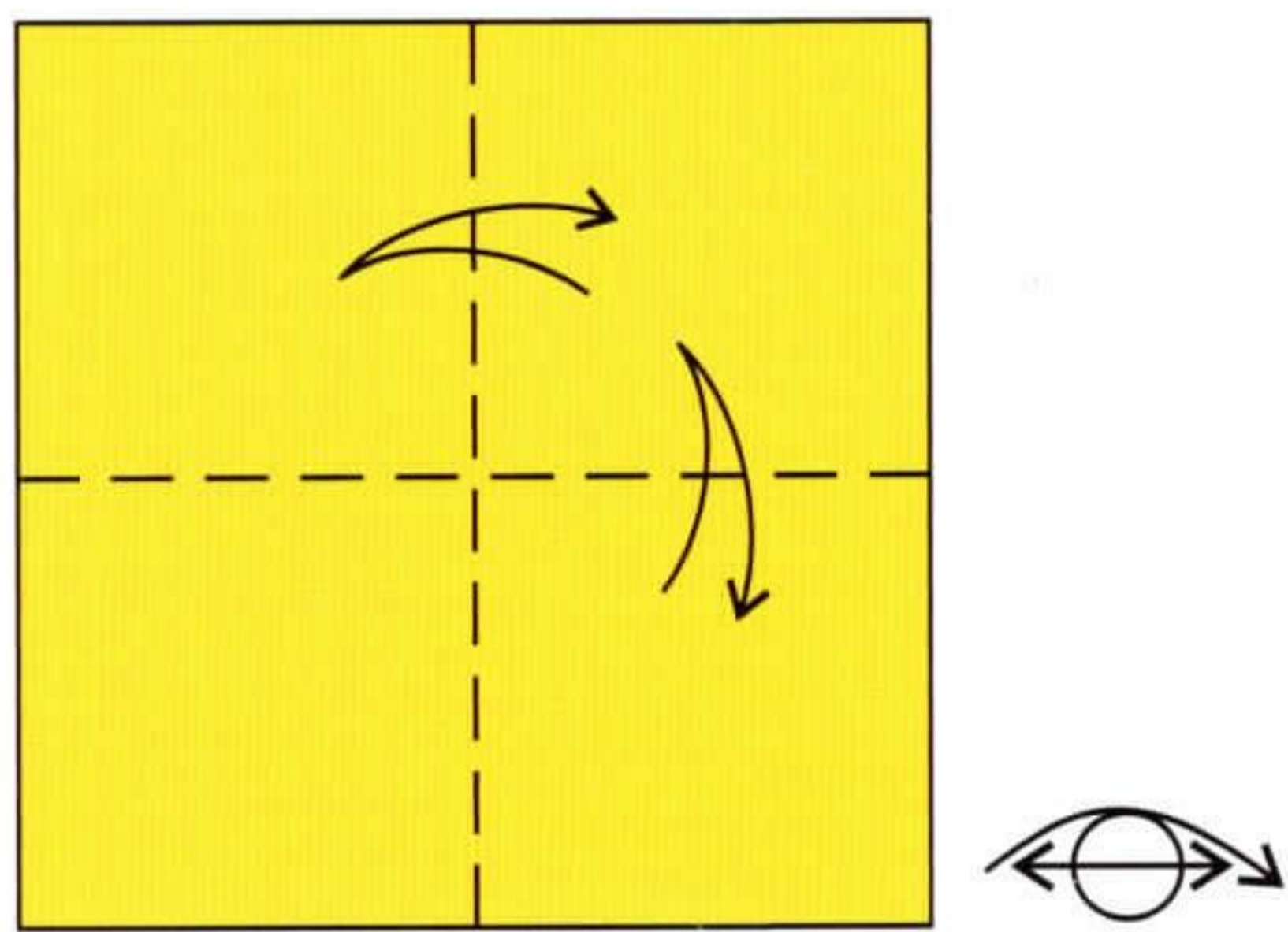

1 Fold and unfold the square in half lengthwise. Then turn the paper over left to right.

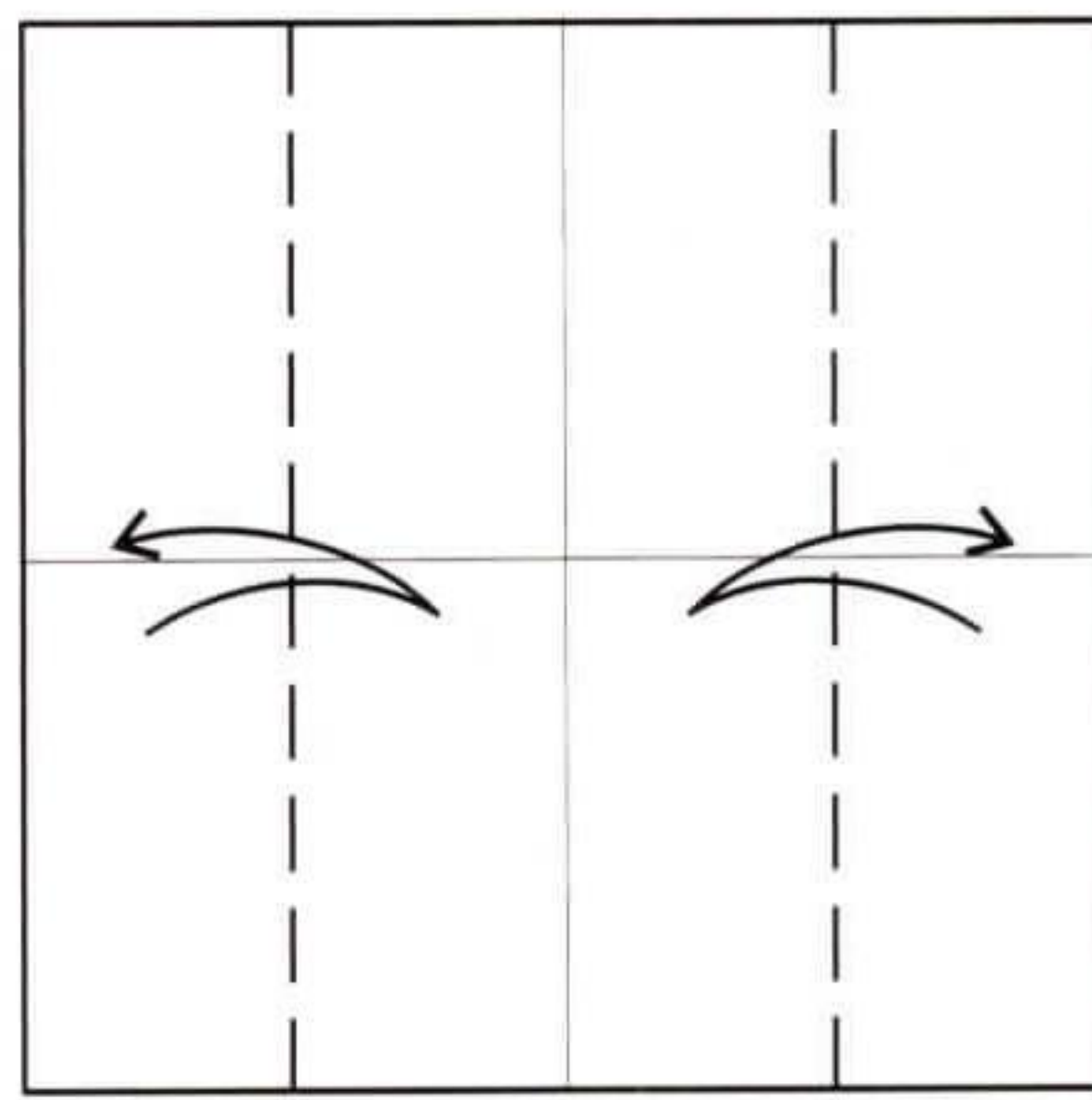

2 Fold and unfold the sides of the square to the middle.

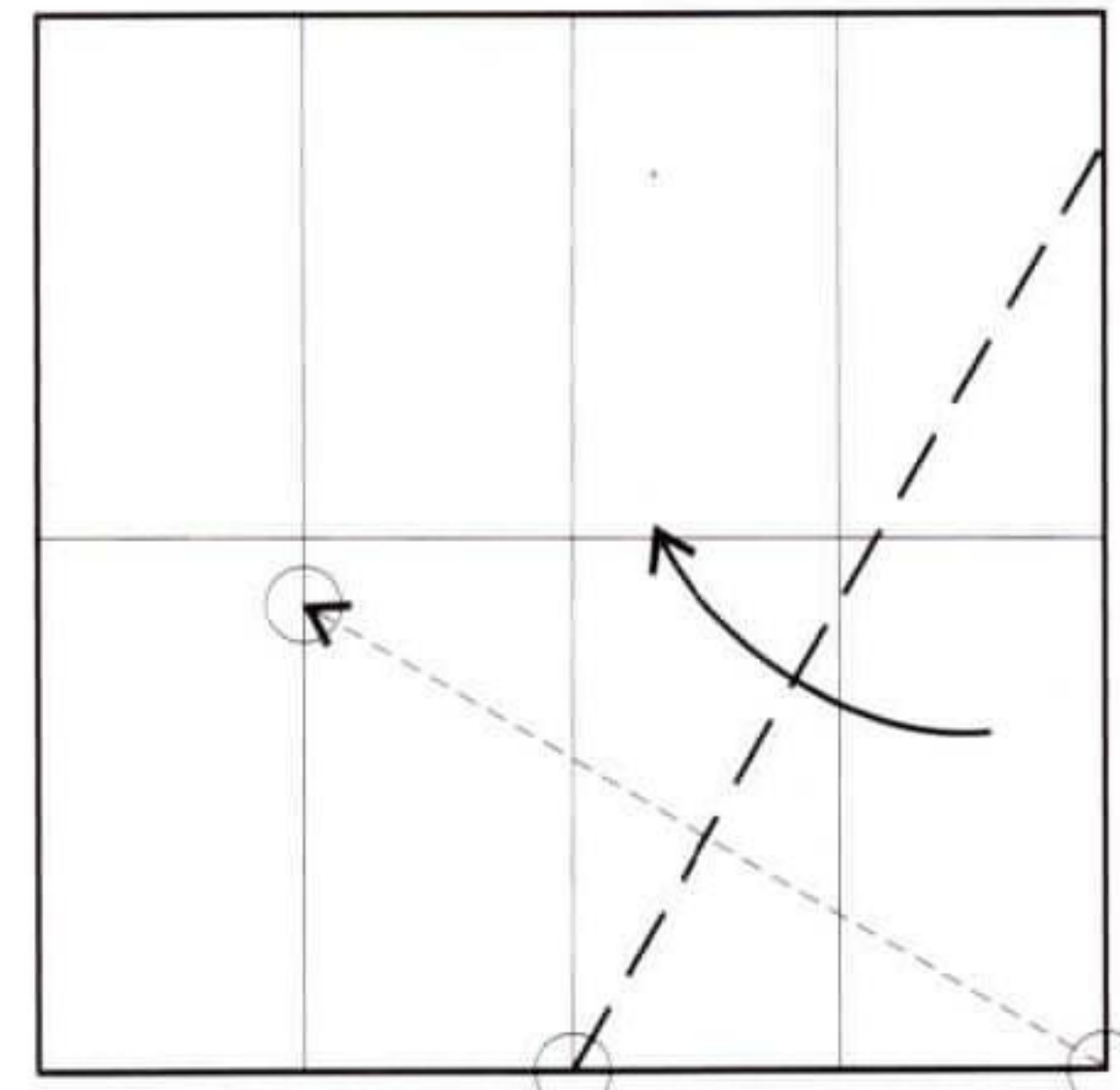

3 Fold the lower right corner of the square in to touch crease. The fold will start from the middle crease.

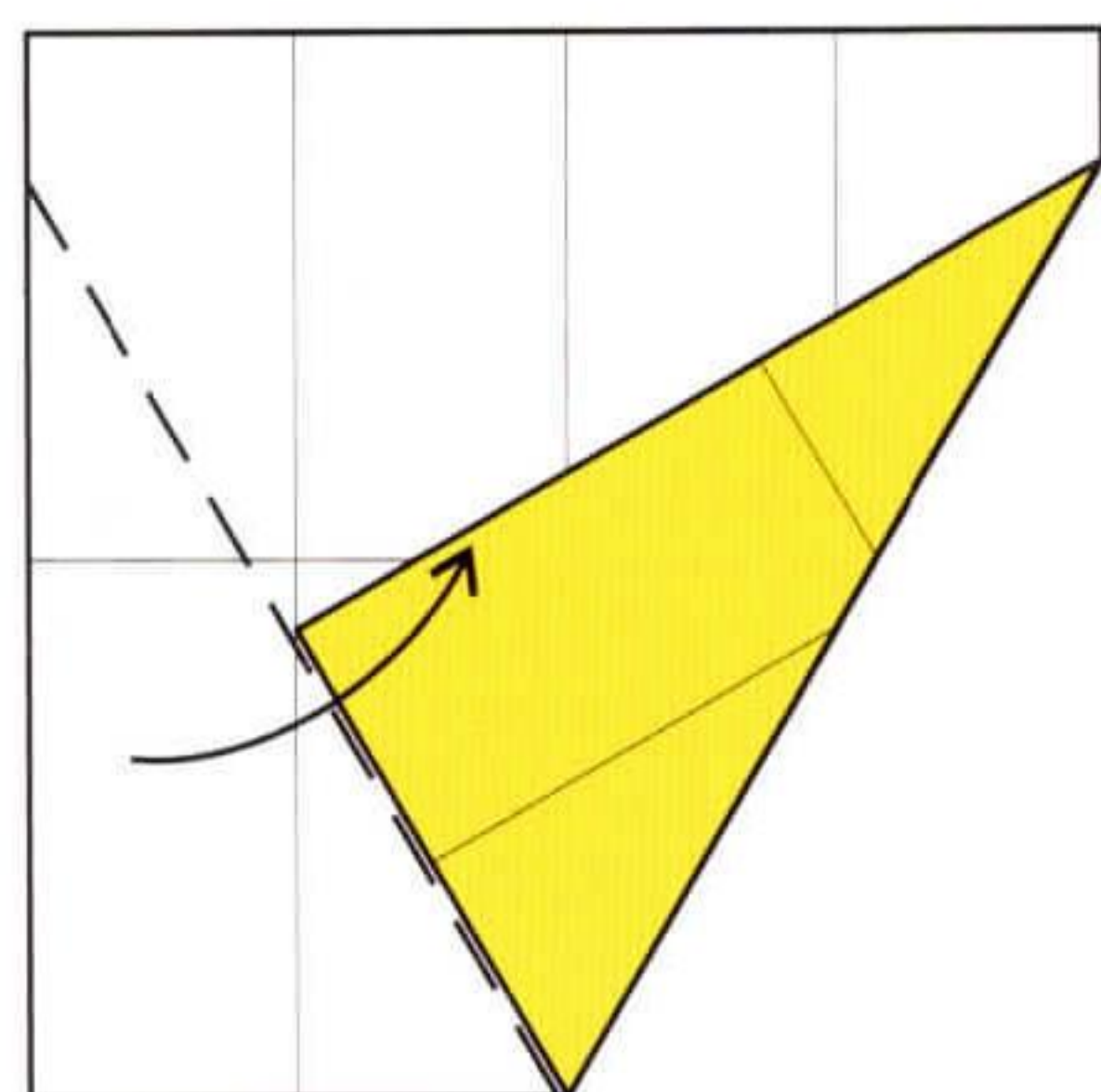

4 Fold the opposite side over the folded edge.

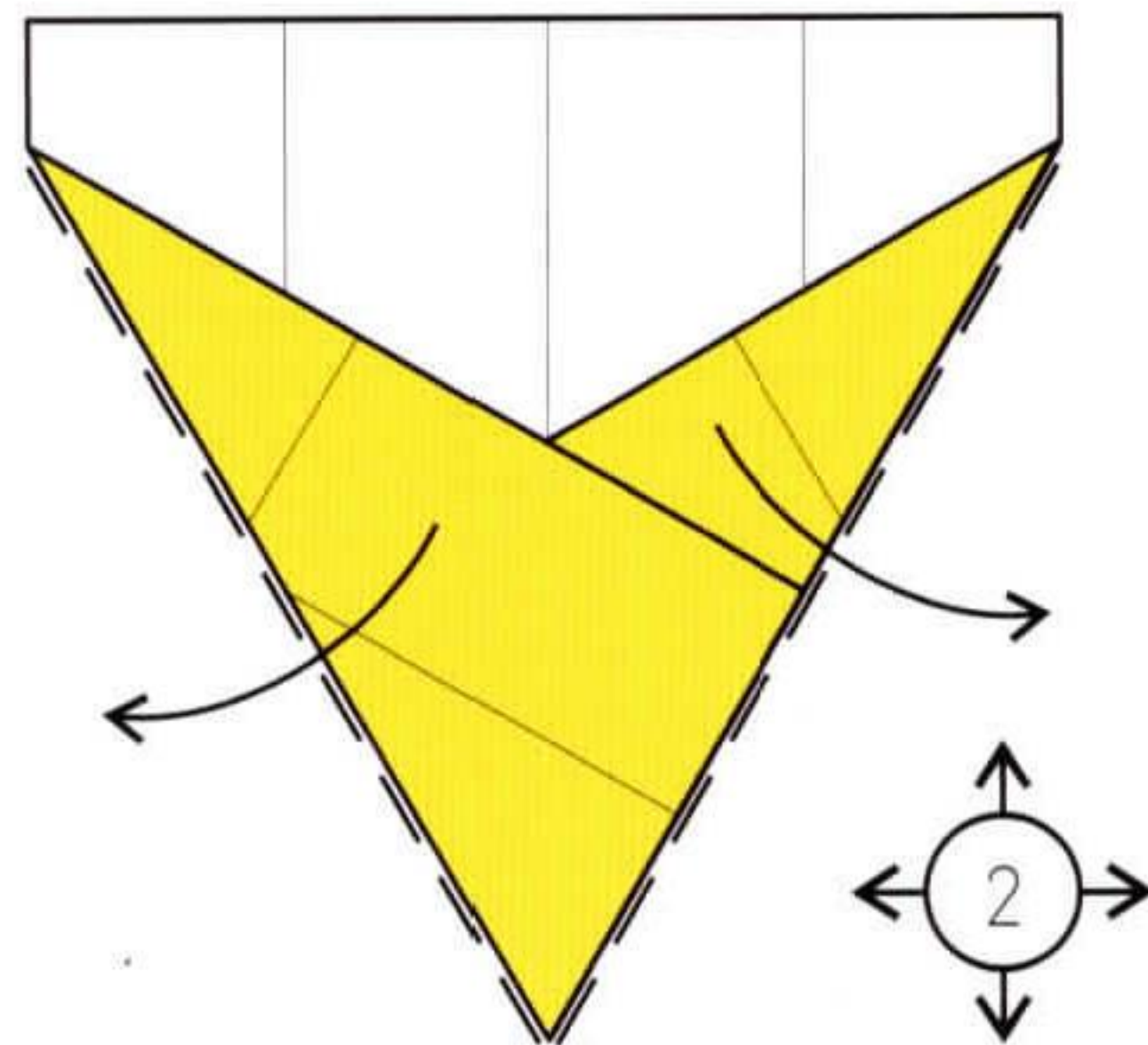

5 Unfold back to a square.

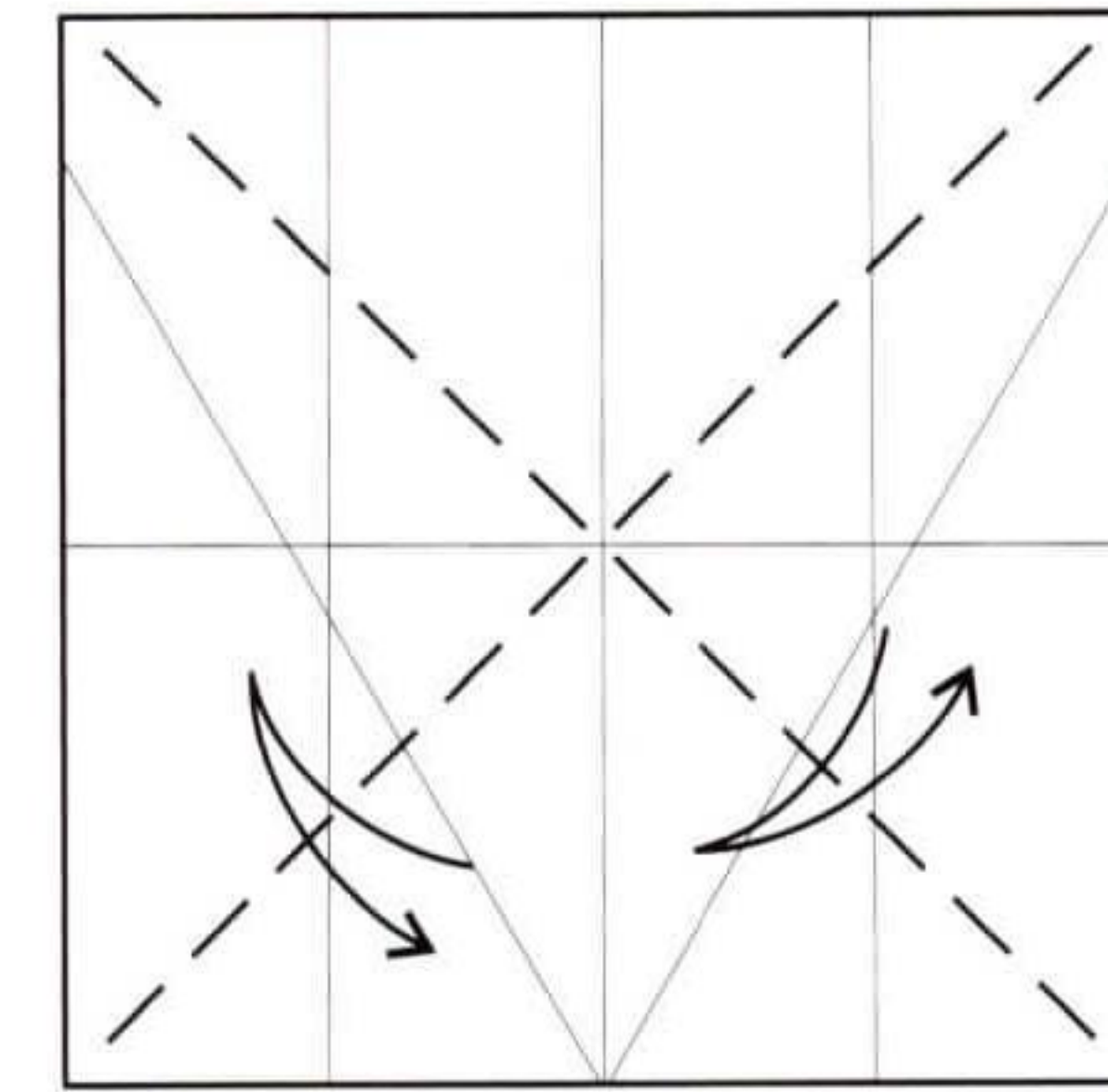

6 Fold and unfold the square in half diagonally.

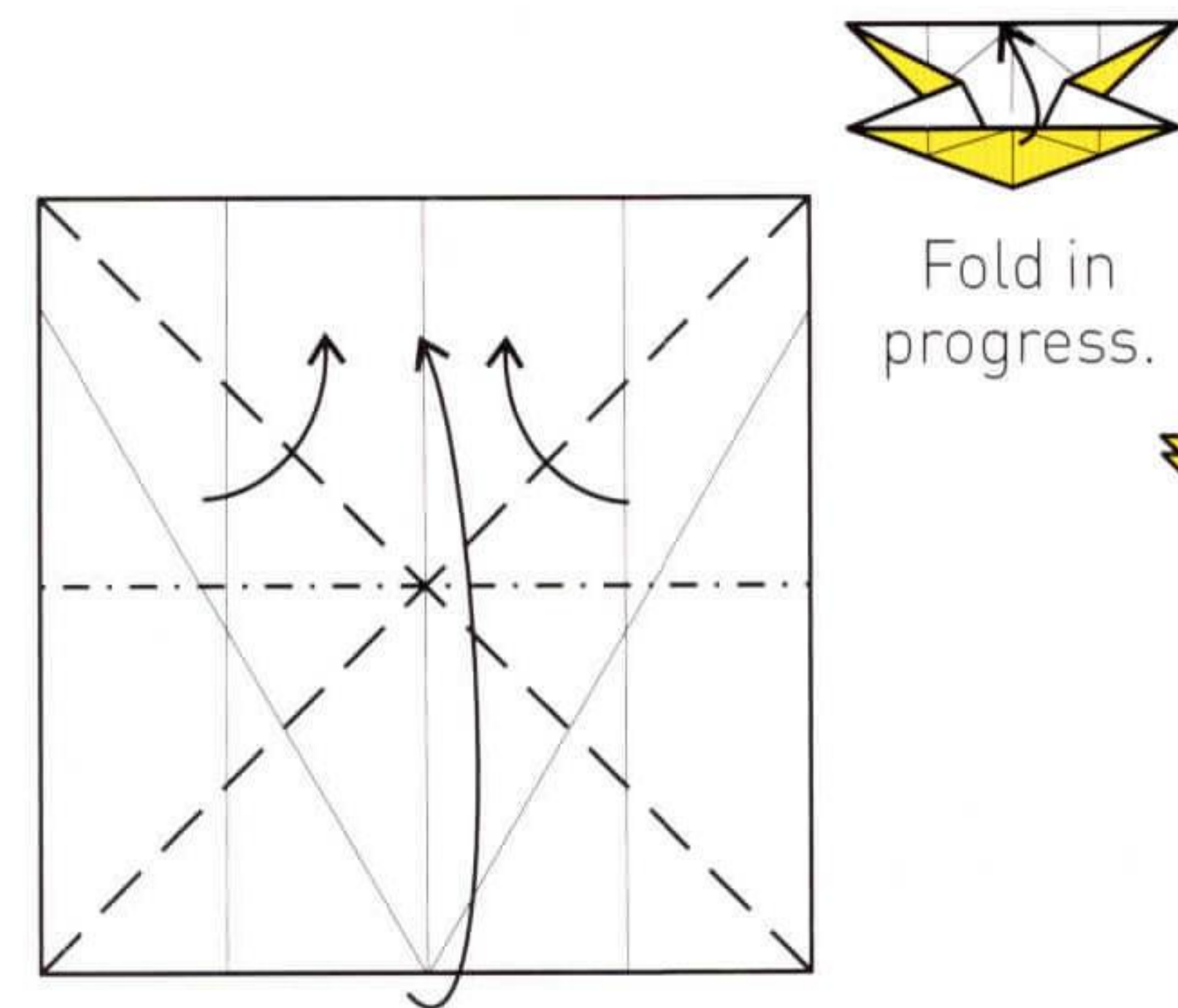

7 Fold the model together to make a waterbomb base.

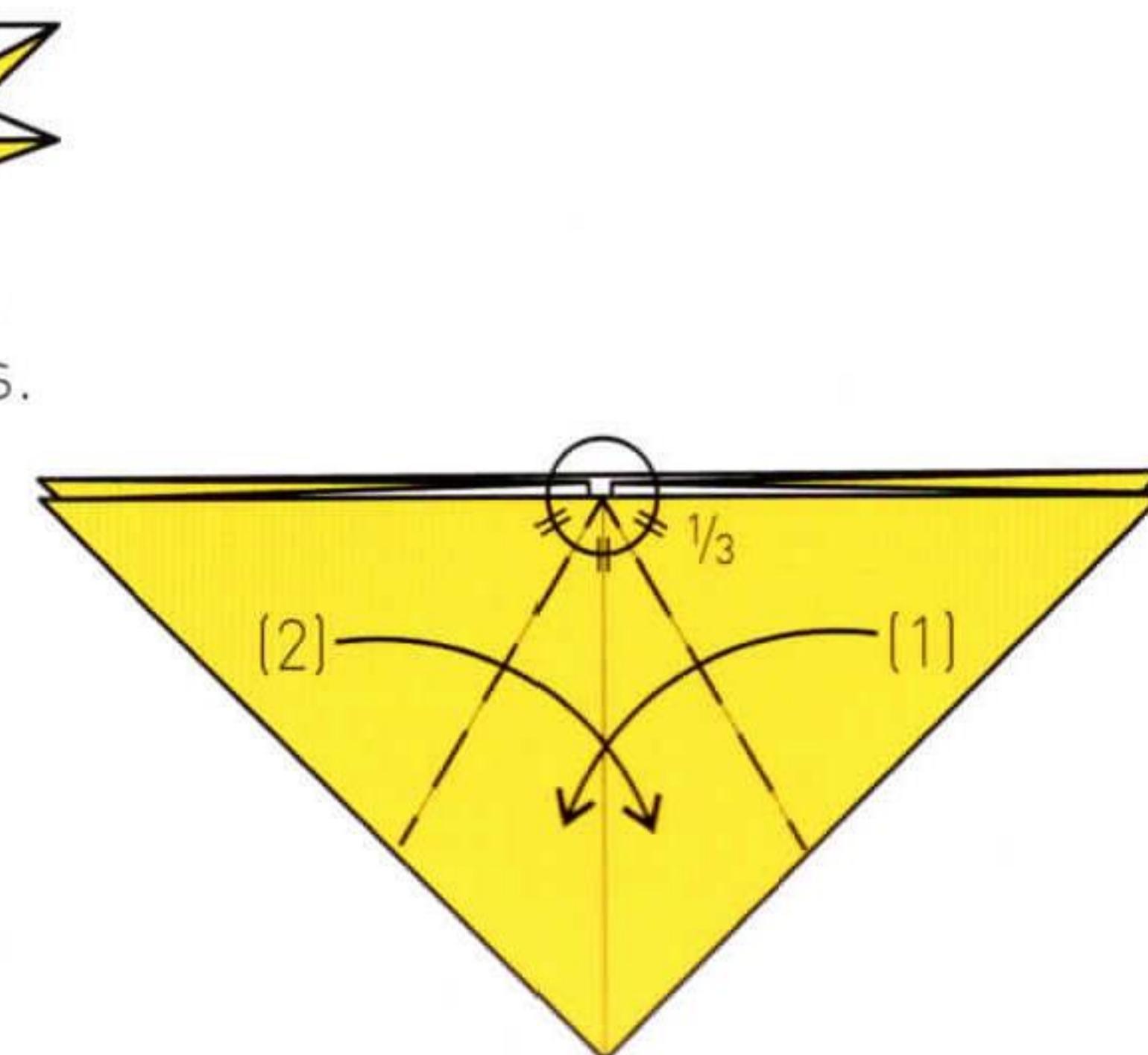

8 Fold the outer corners in, along the creases made previously.

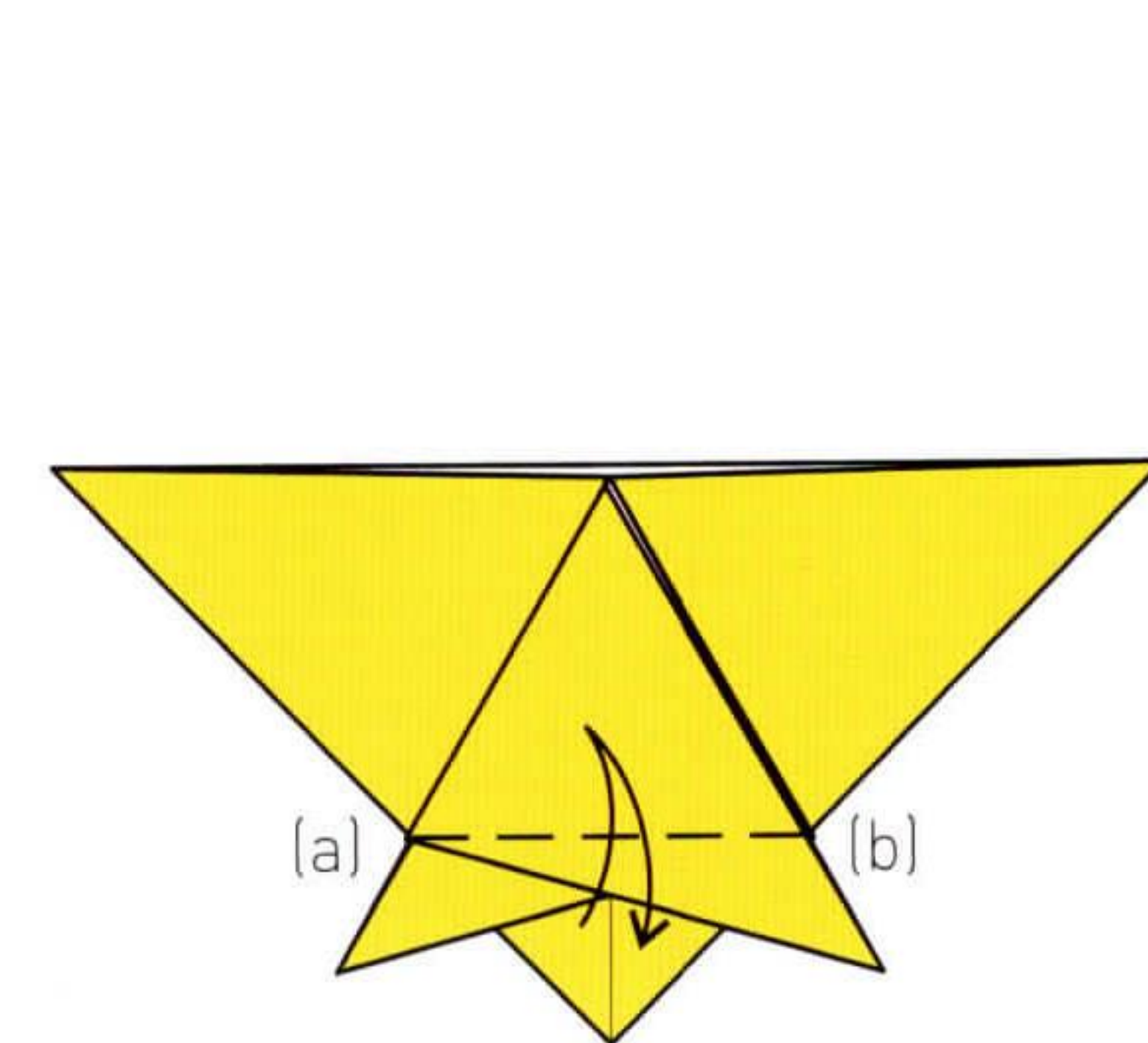

9 Fold and unfold the upper layer along (a-b).

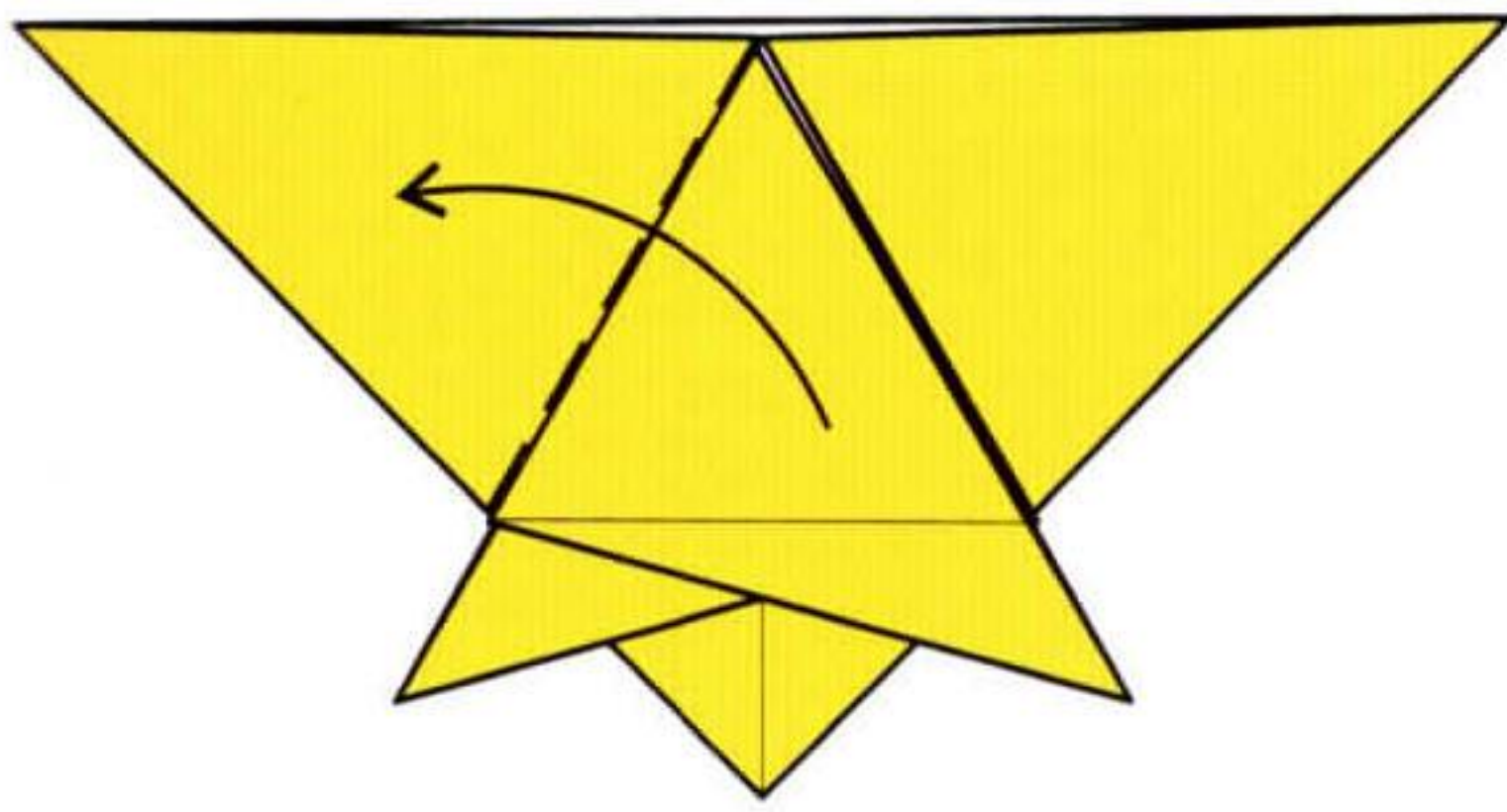

10 Fold one side up.

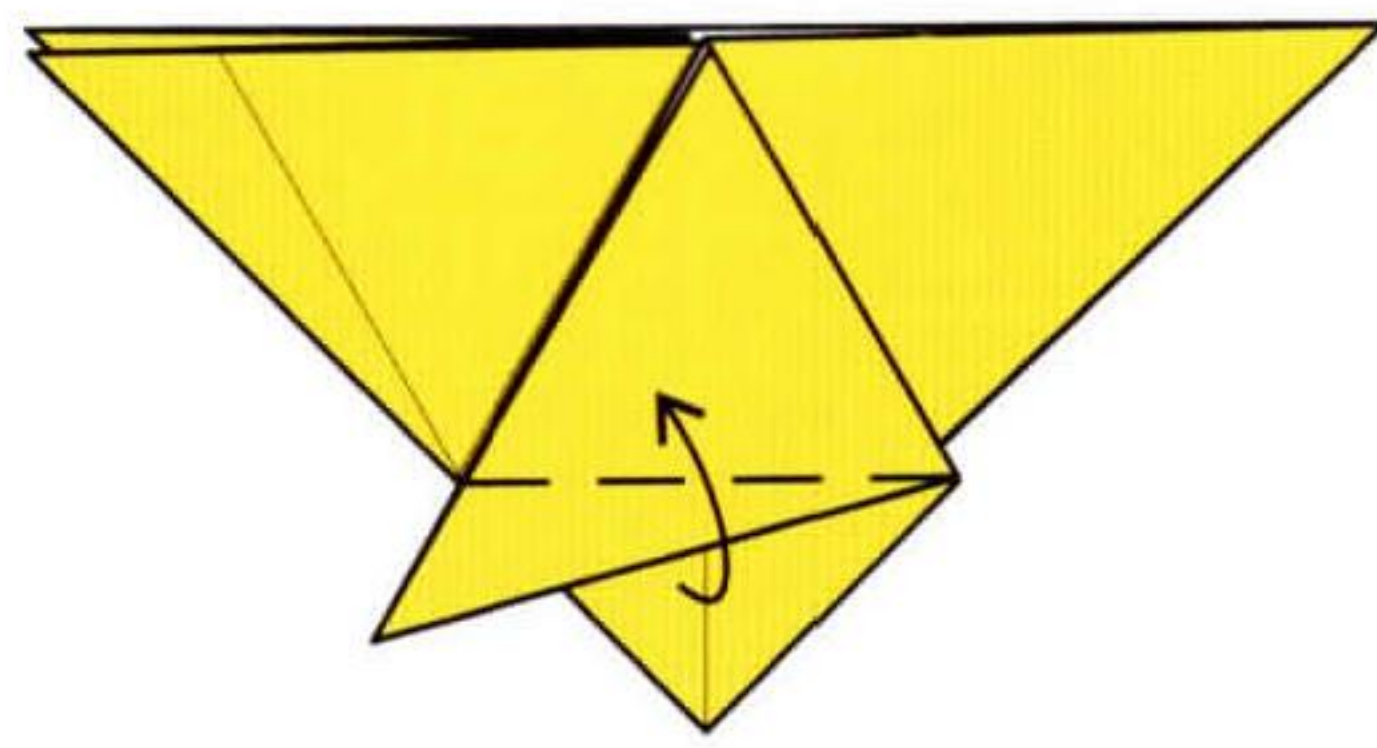

11 Fold the edge of the lower section up along the crease made previously.

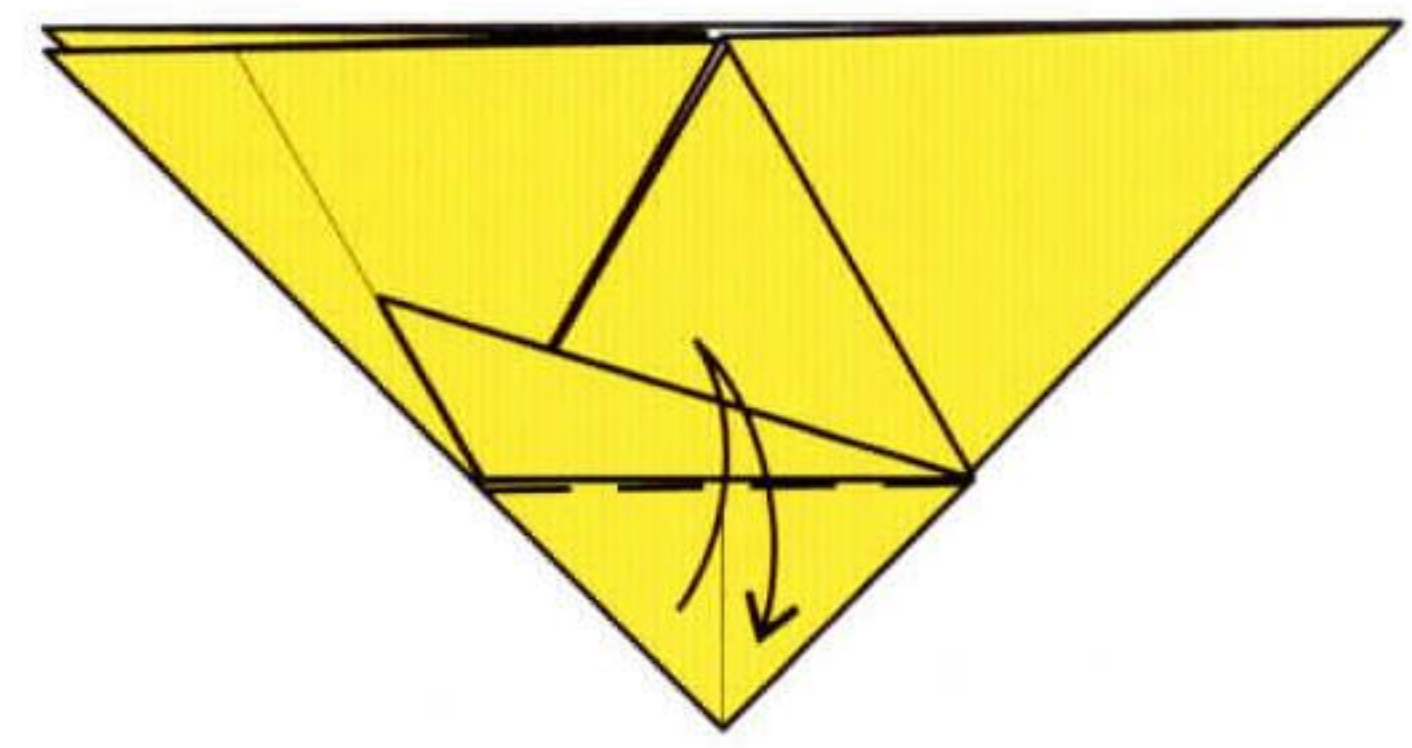

12 Fold the lower corner up over the adjacent folded edge, and unfold.

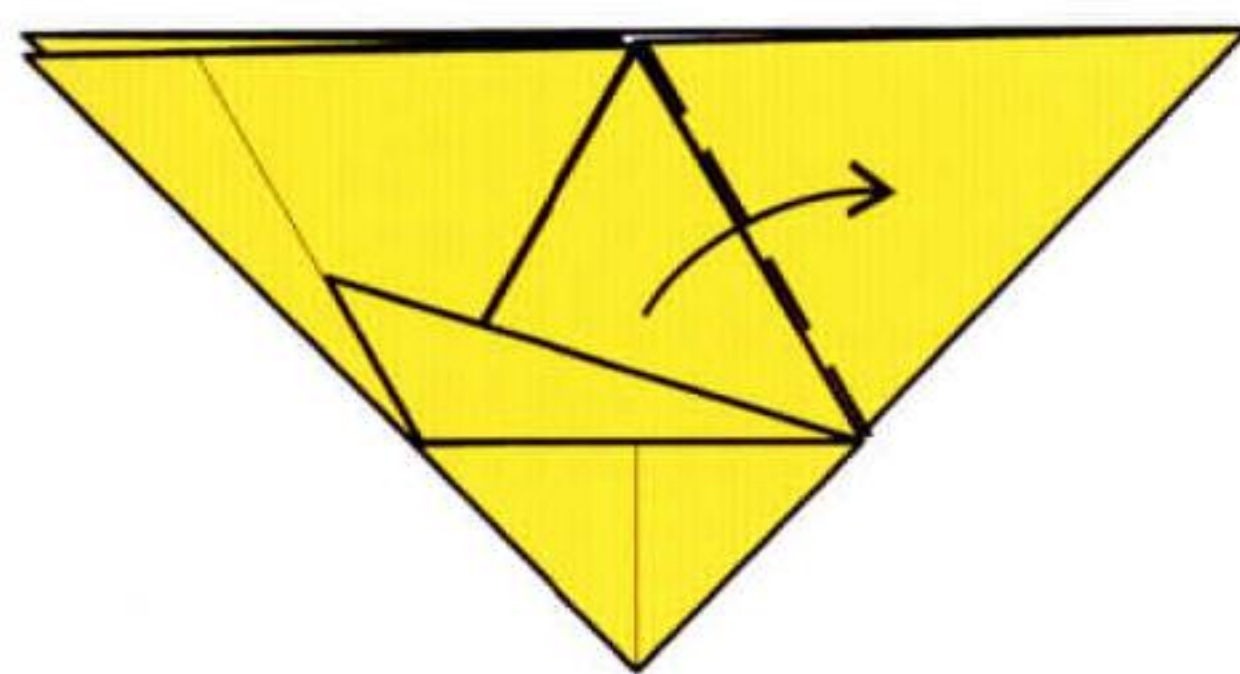

13 Fold the upper layer up.

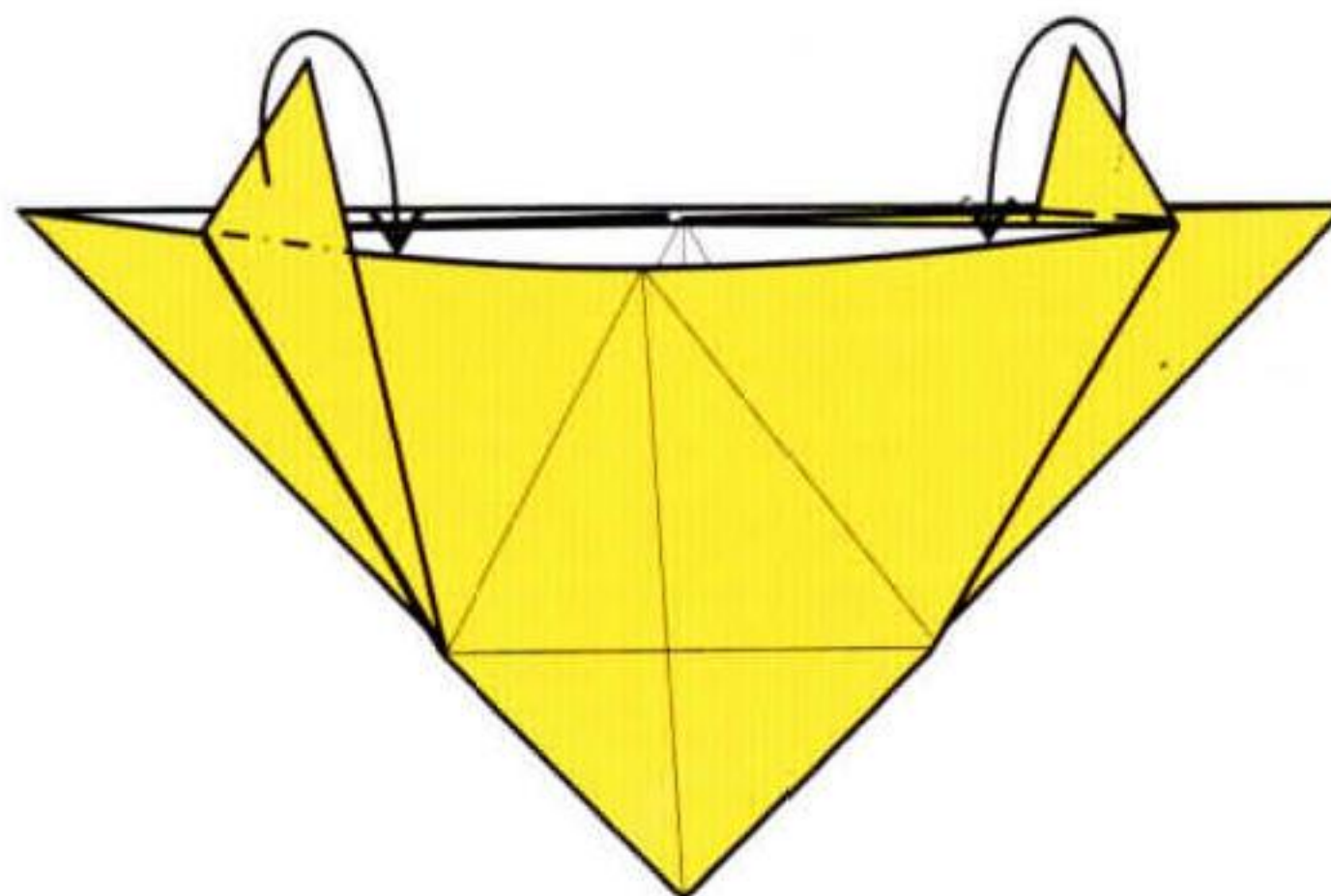

14 Fold the corners over and into the model between the layers.

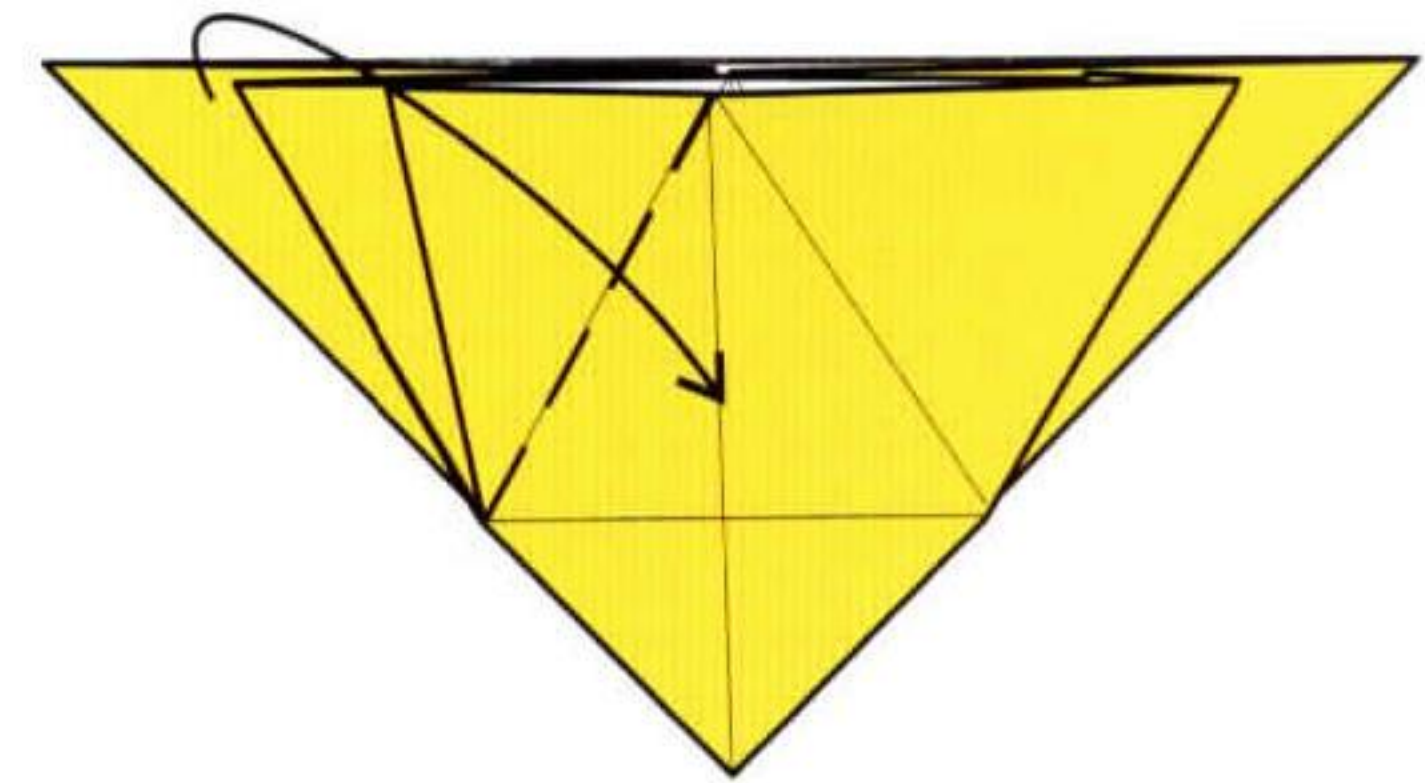

15 Fold one side over.

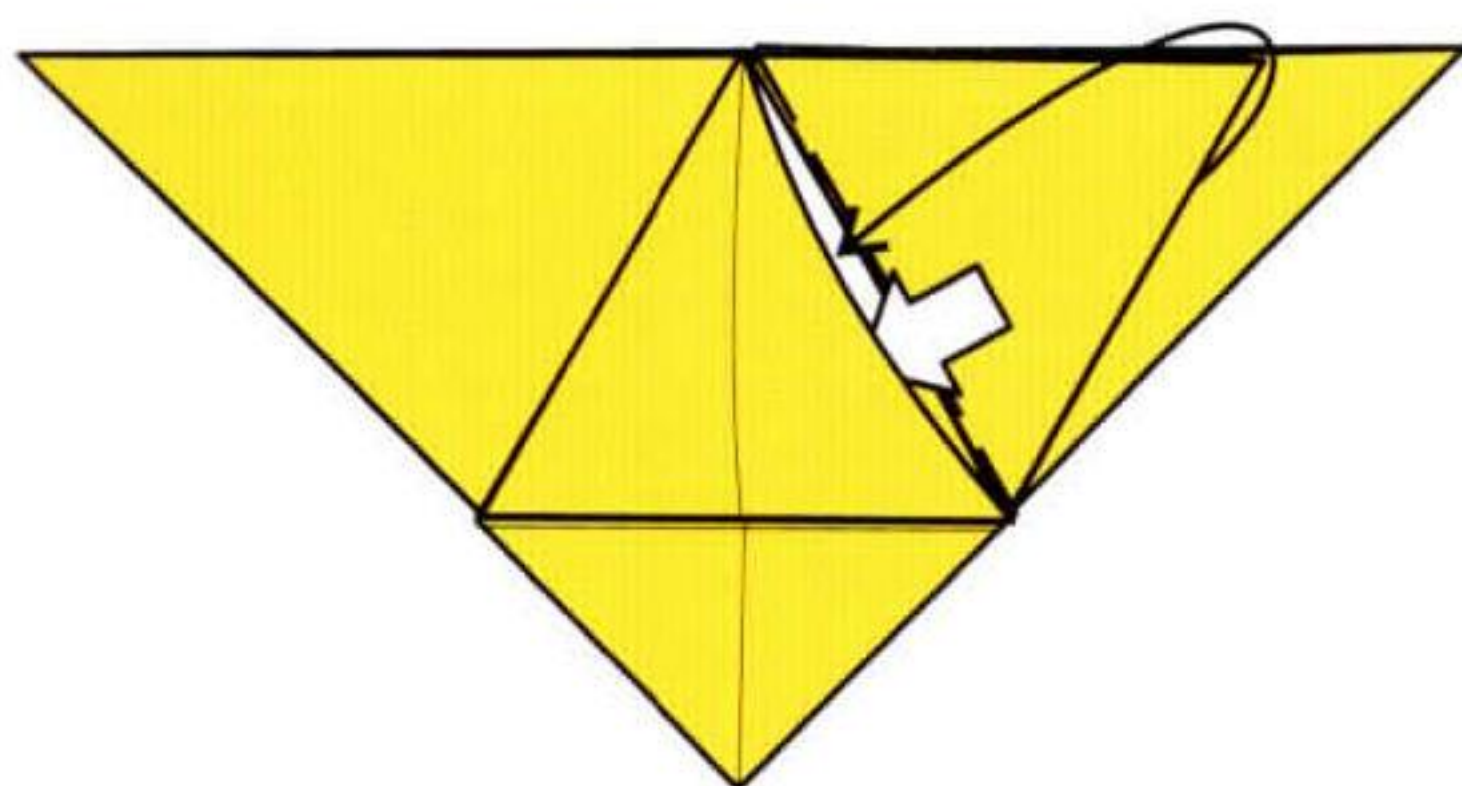

16 Fold the corner over and tuck it into the adjacent corner.

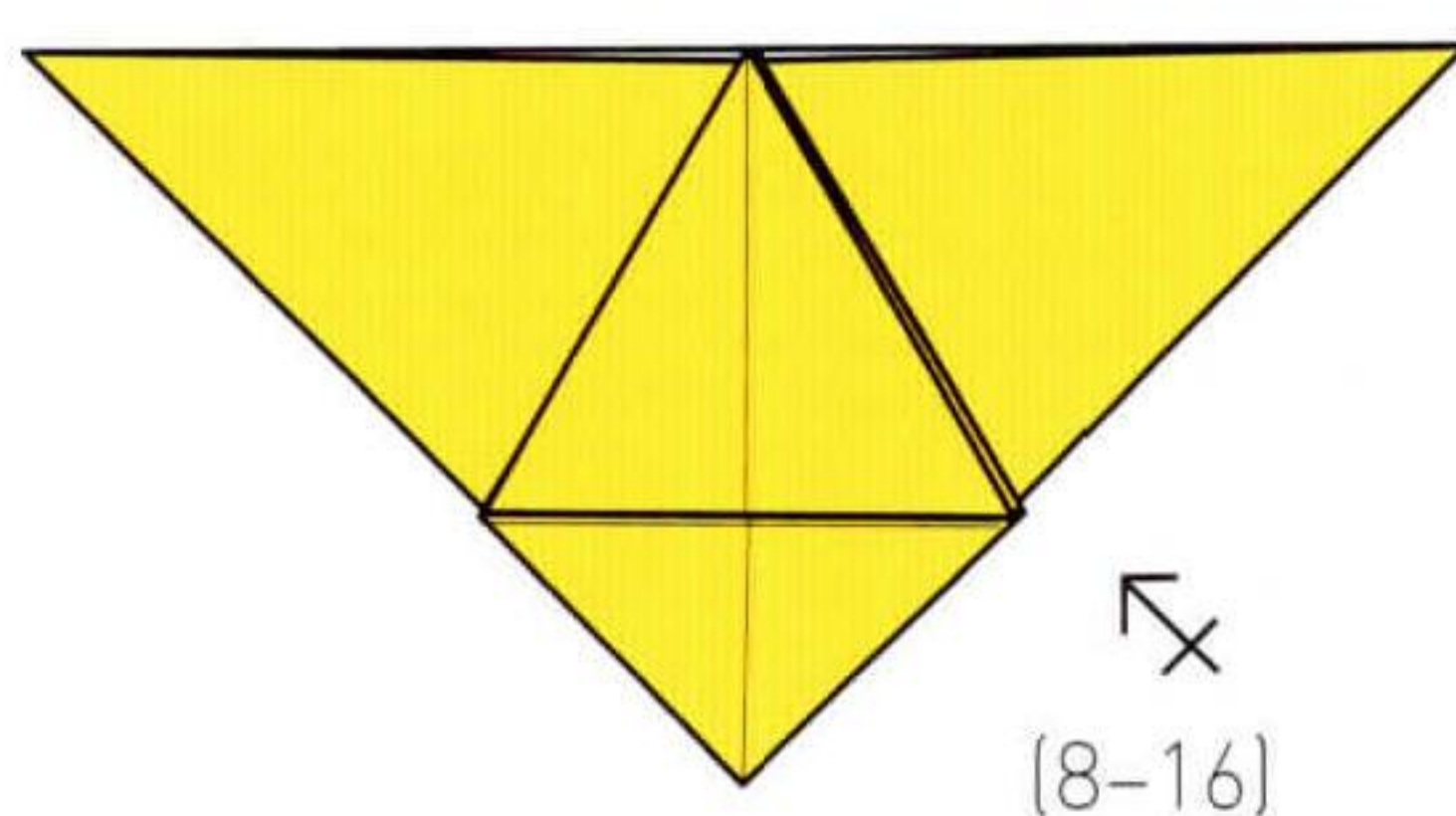

17 Repeat steps 8 to 16 behind.

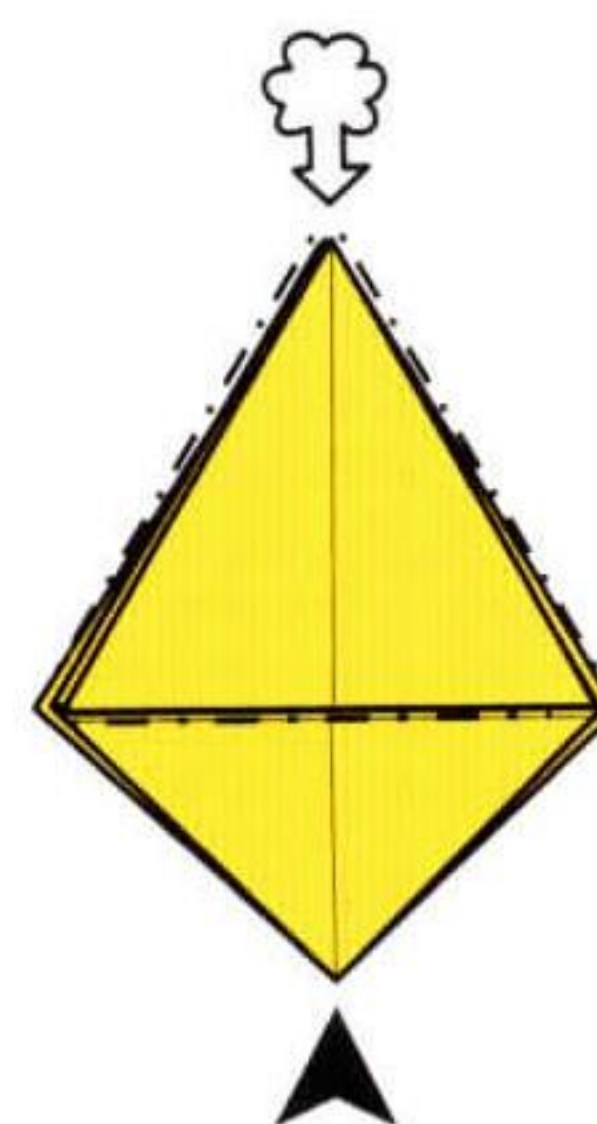

18 Pop up the model by pushing the base in and opening the sides.

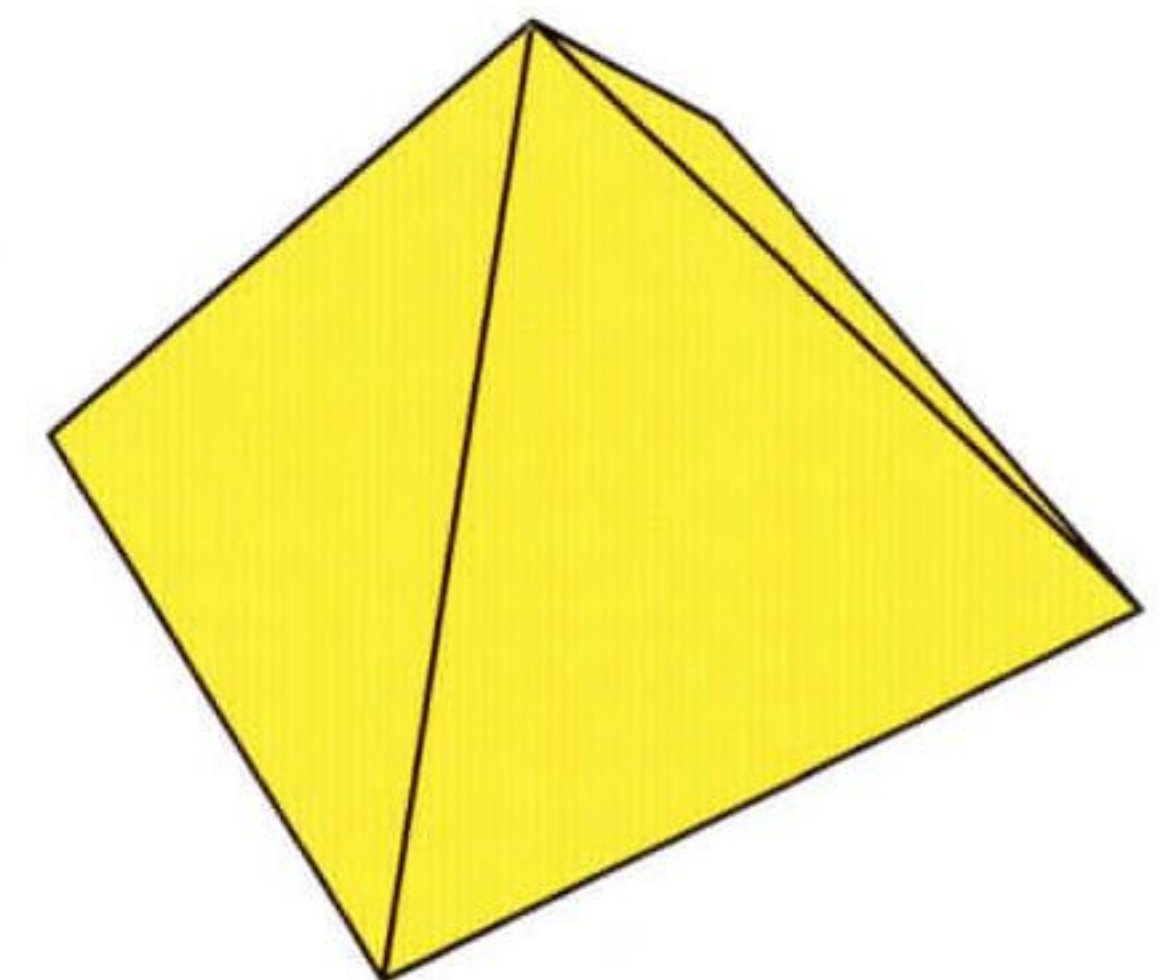

19 Complete.

TWISTS AND TURNS

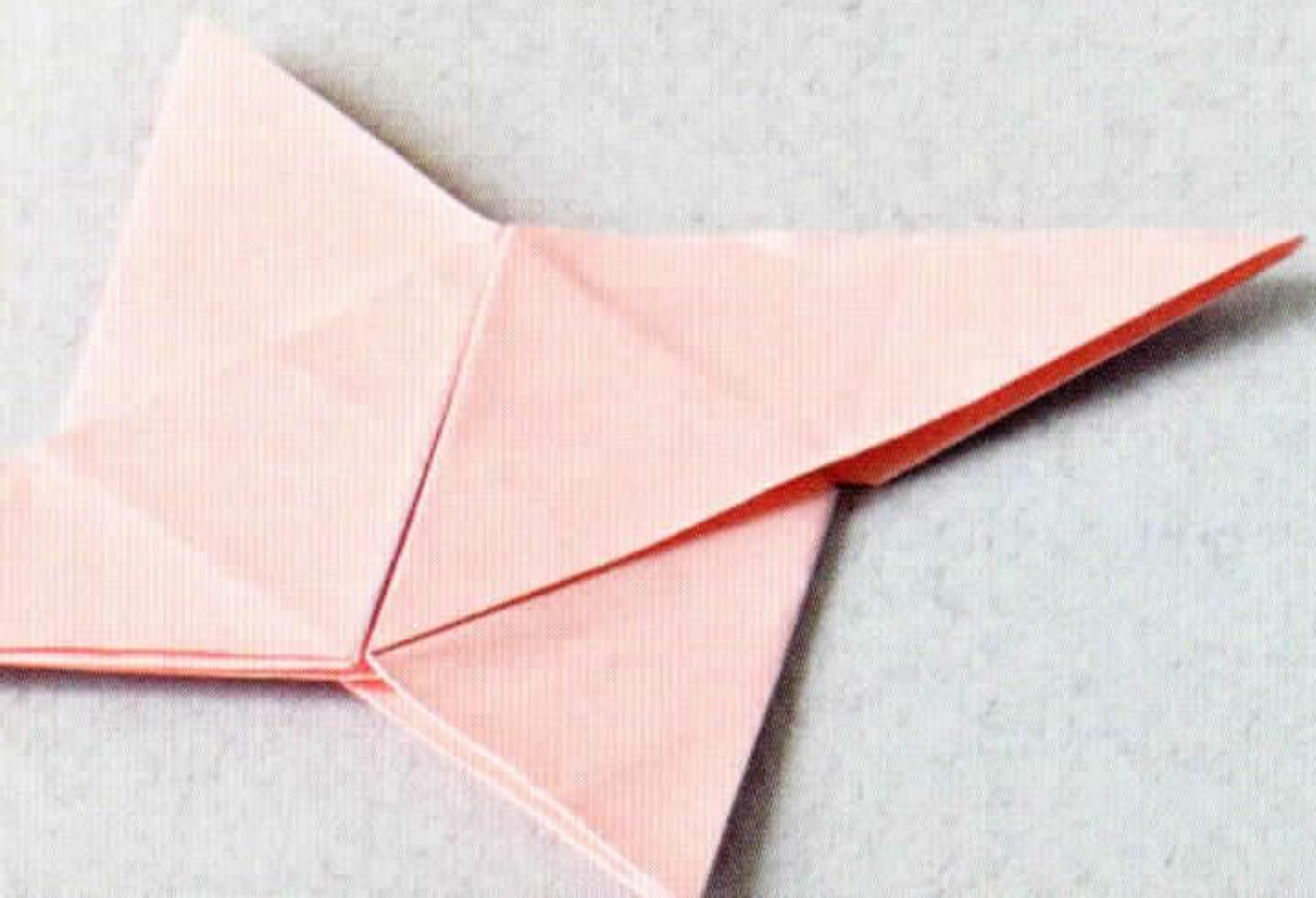
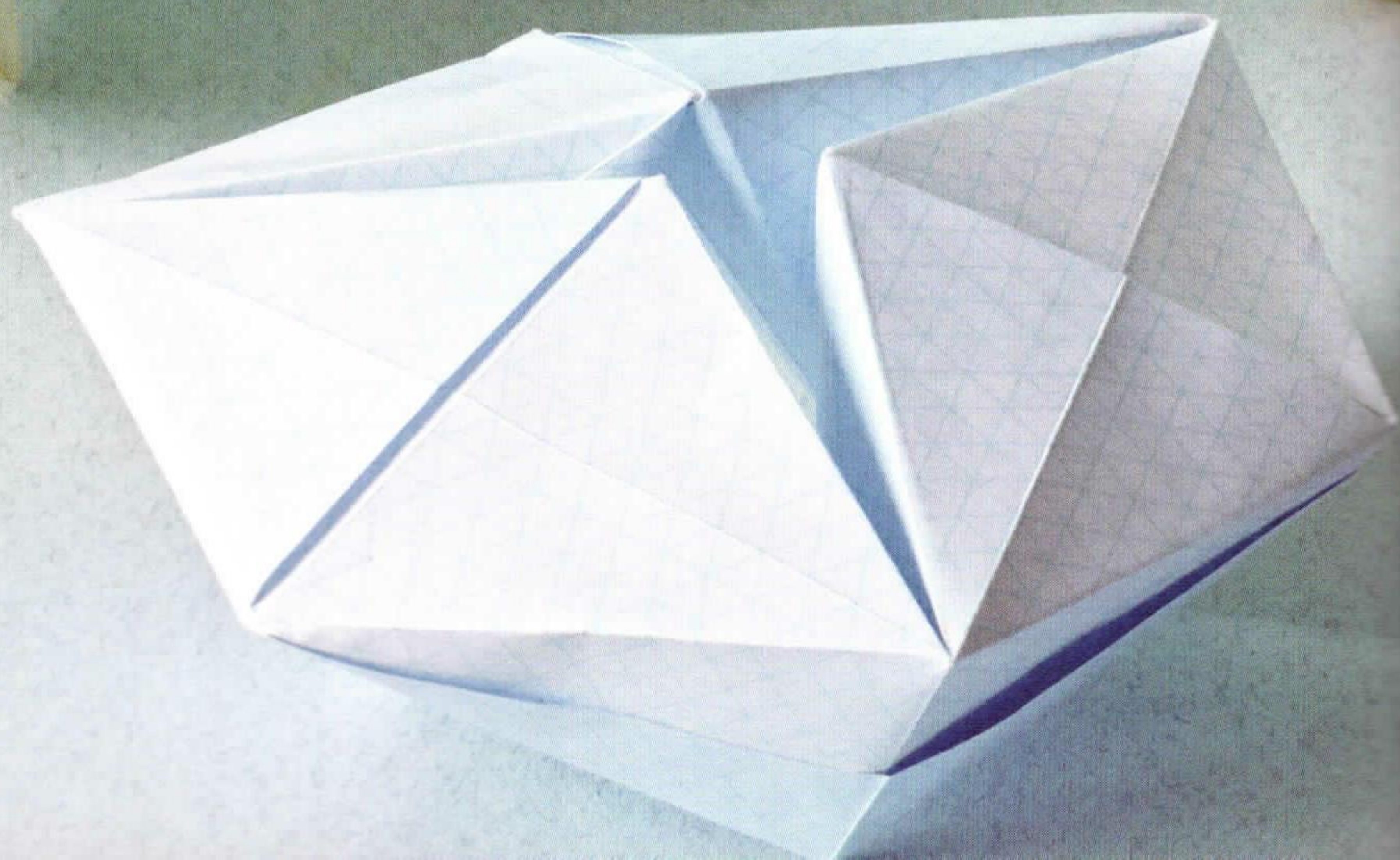
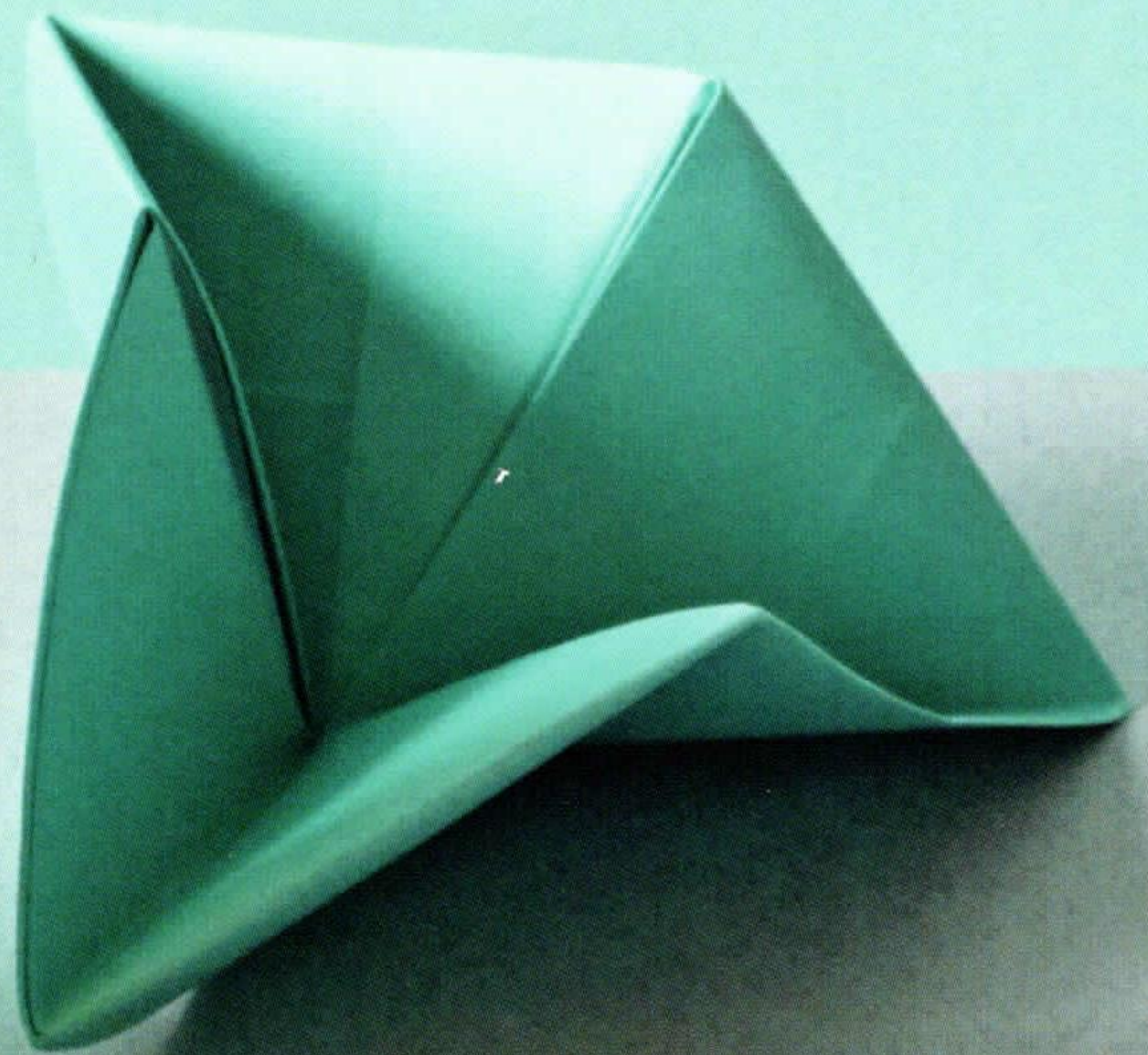
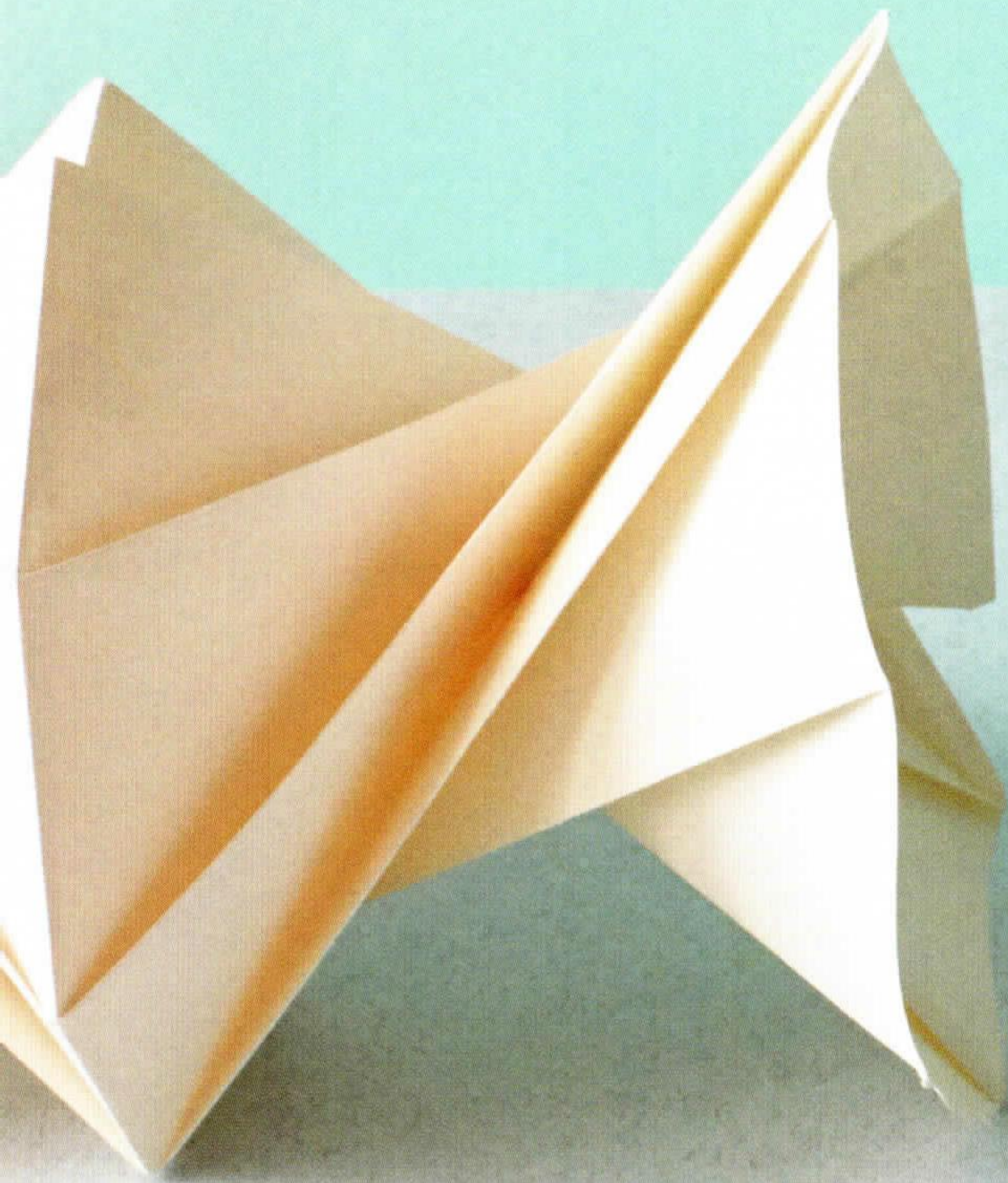



Twister



The twister is an abstract shape constructed by applying a series of regular diagonal folds. These folds cause the model to curve. When pressure is applied to both sides, the model pops up and one side slides into the other. The final folds lock the model in place.

13.5 X 18CM (5⅓ X 7IN)

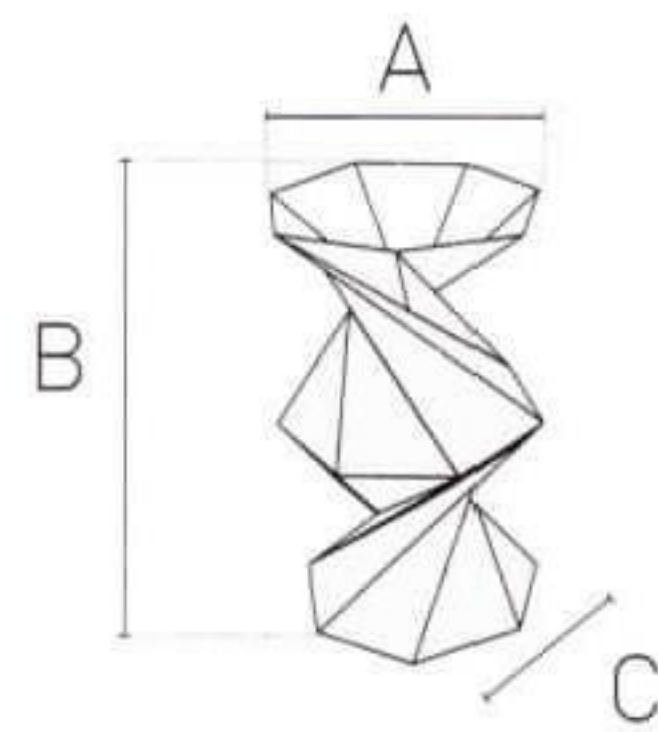
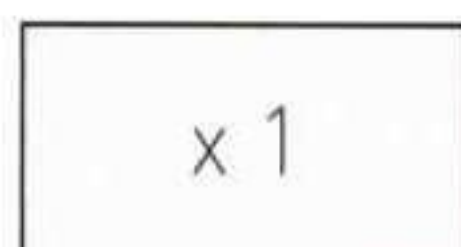

A	5cm	(2in)
B	9cm	(3½in)
C	5cm	(2in)

START WITH A 3 X 4 RECTANGLE, COLOURED SIDE DOWN.

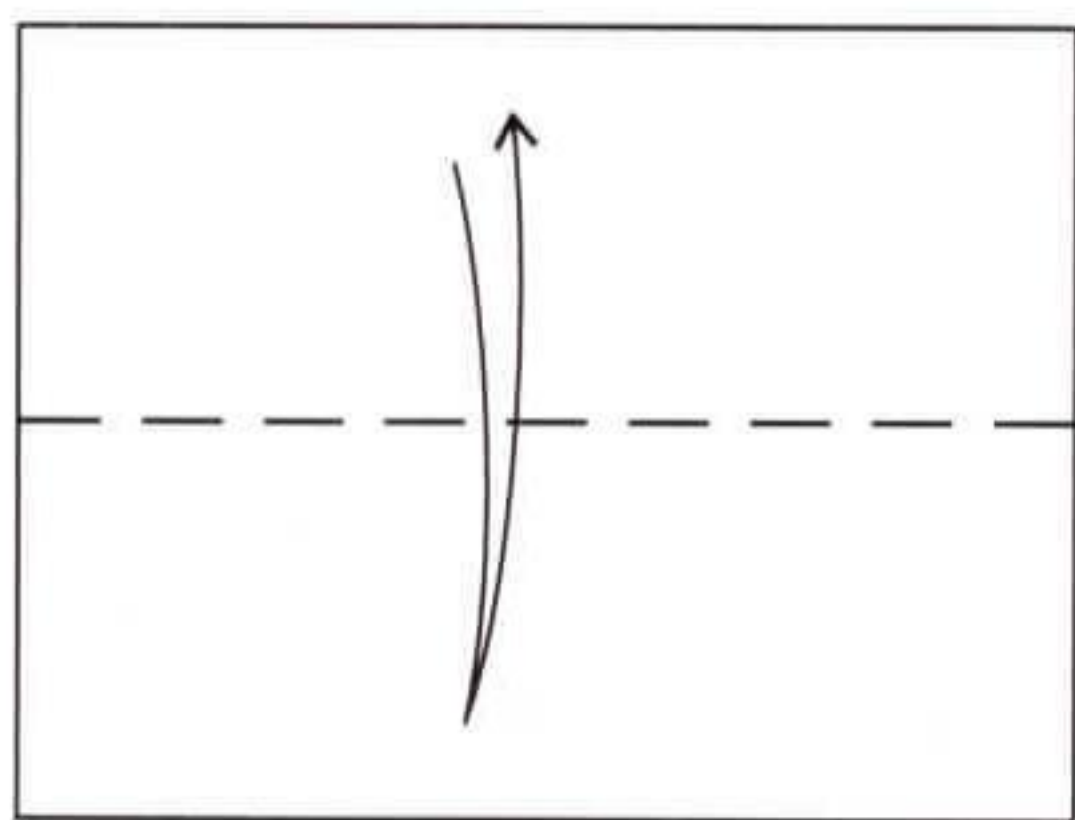

1 Fold and unfold the paper in half lengthwise.

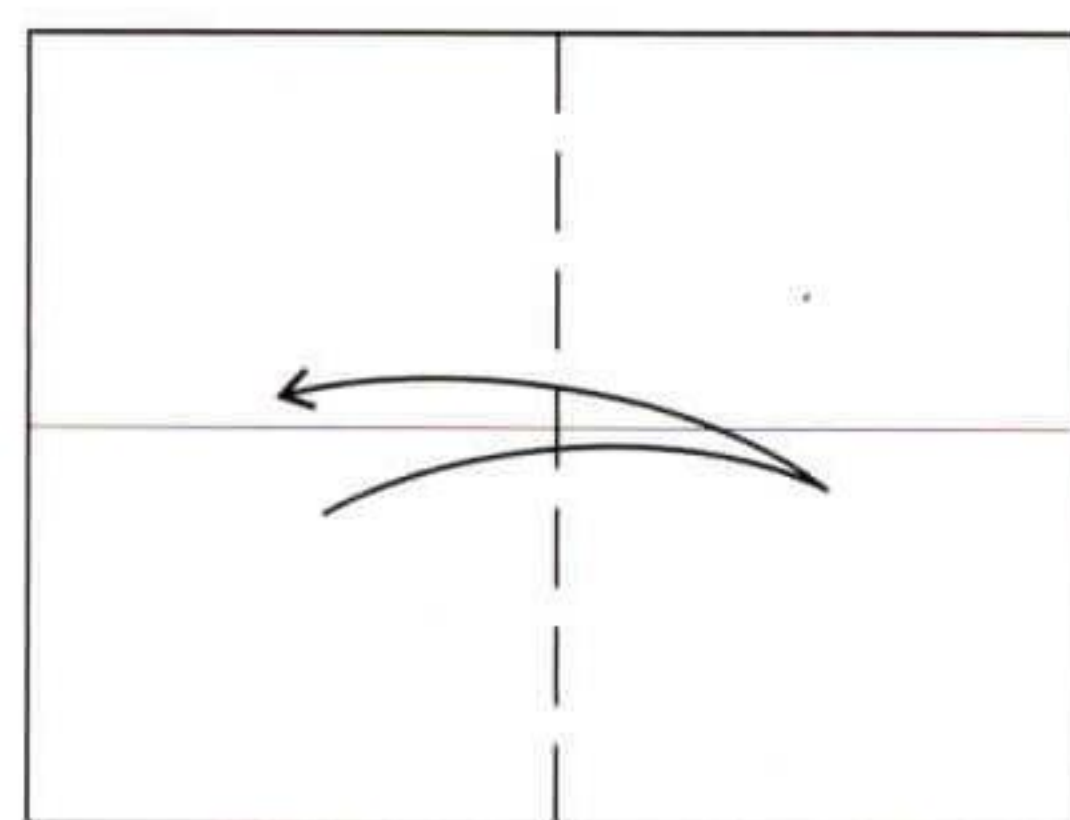

2 Fold and unfold the middle crease.

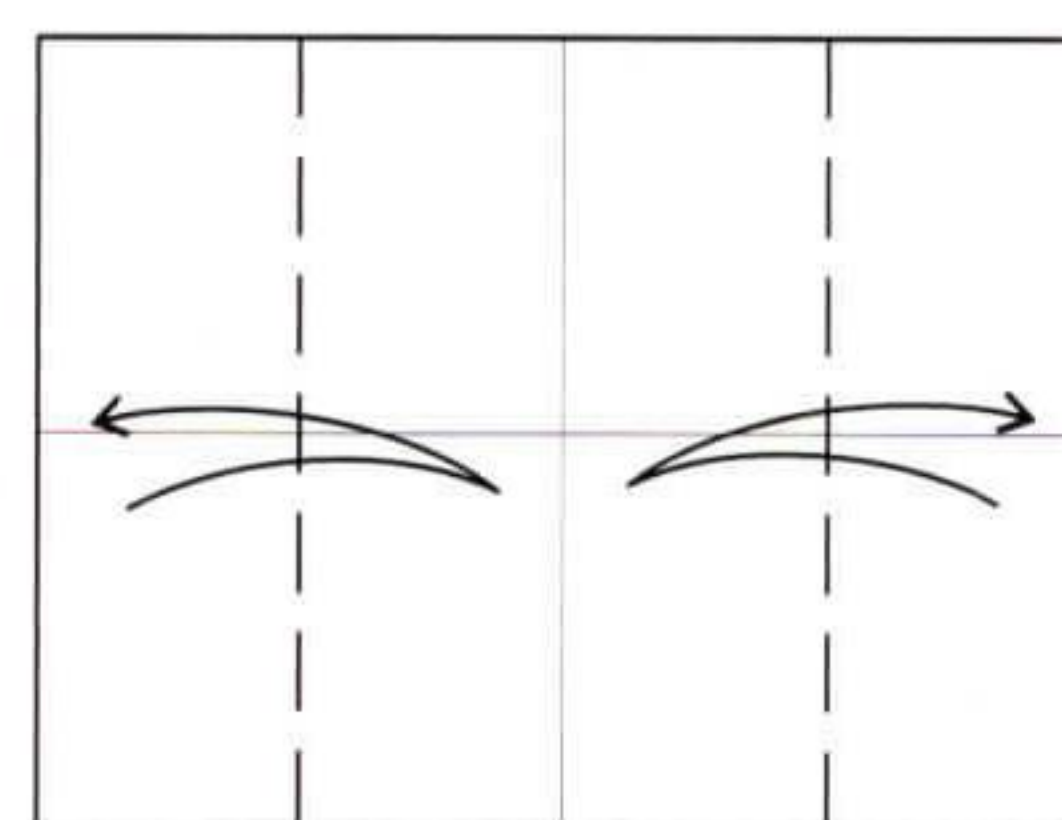

3 Fold and unfold the edges to the middle crease.

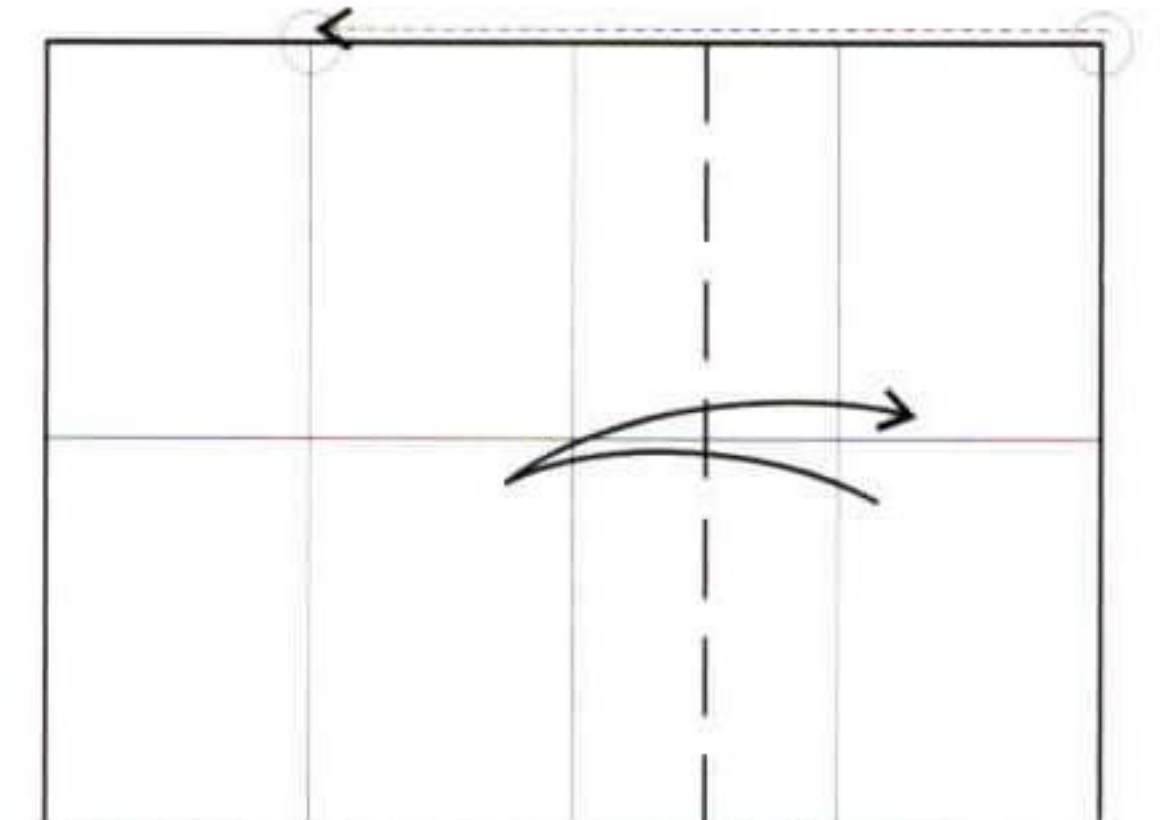

4 Fold and unfold between the creases made previously.

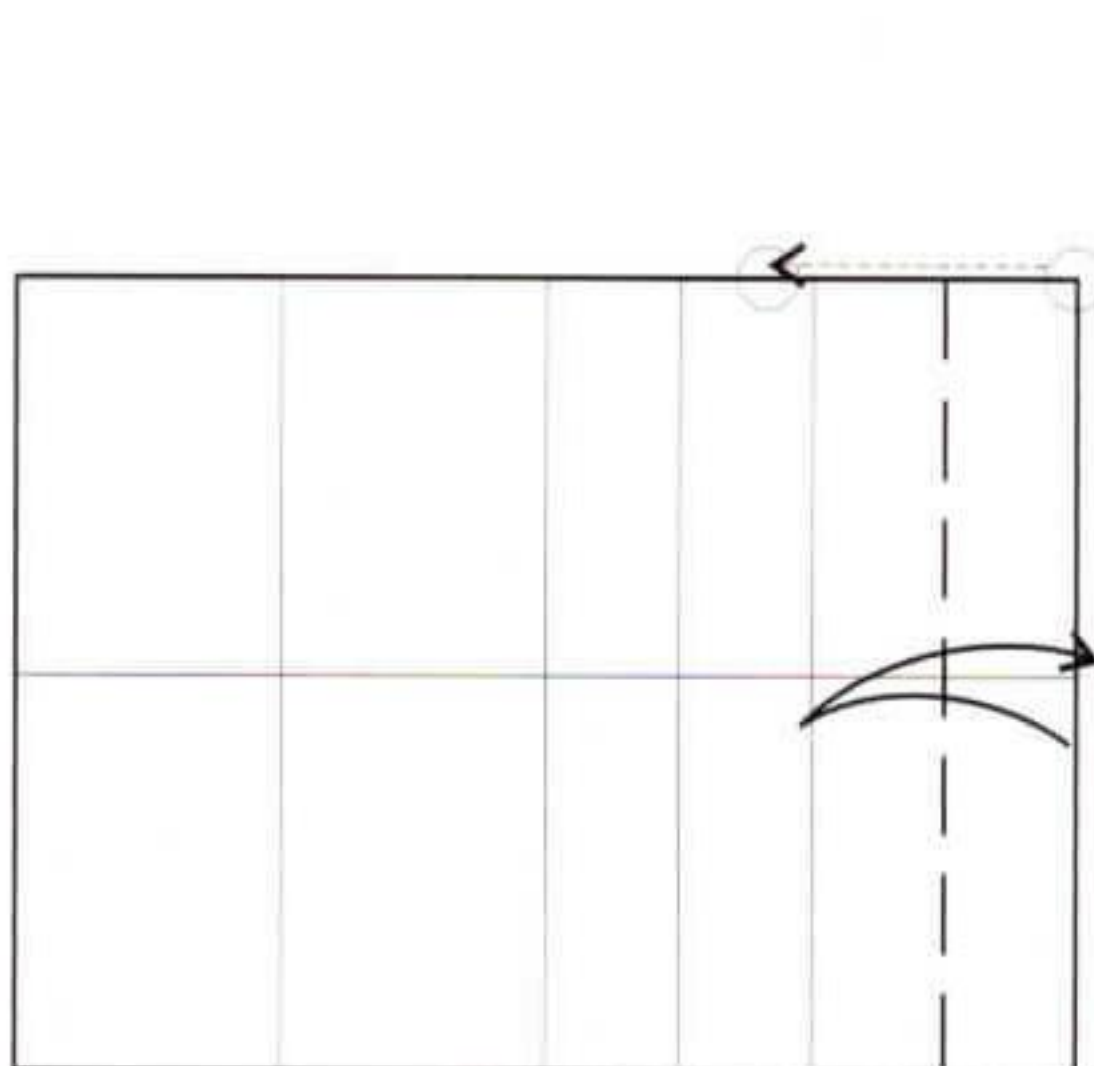

5 Fold and unfold between the outer edge and the adjacent crease.

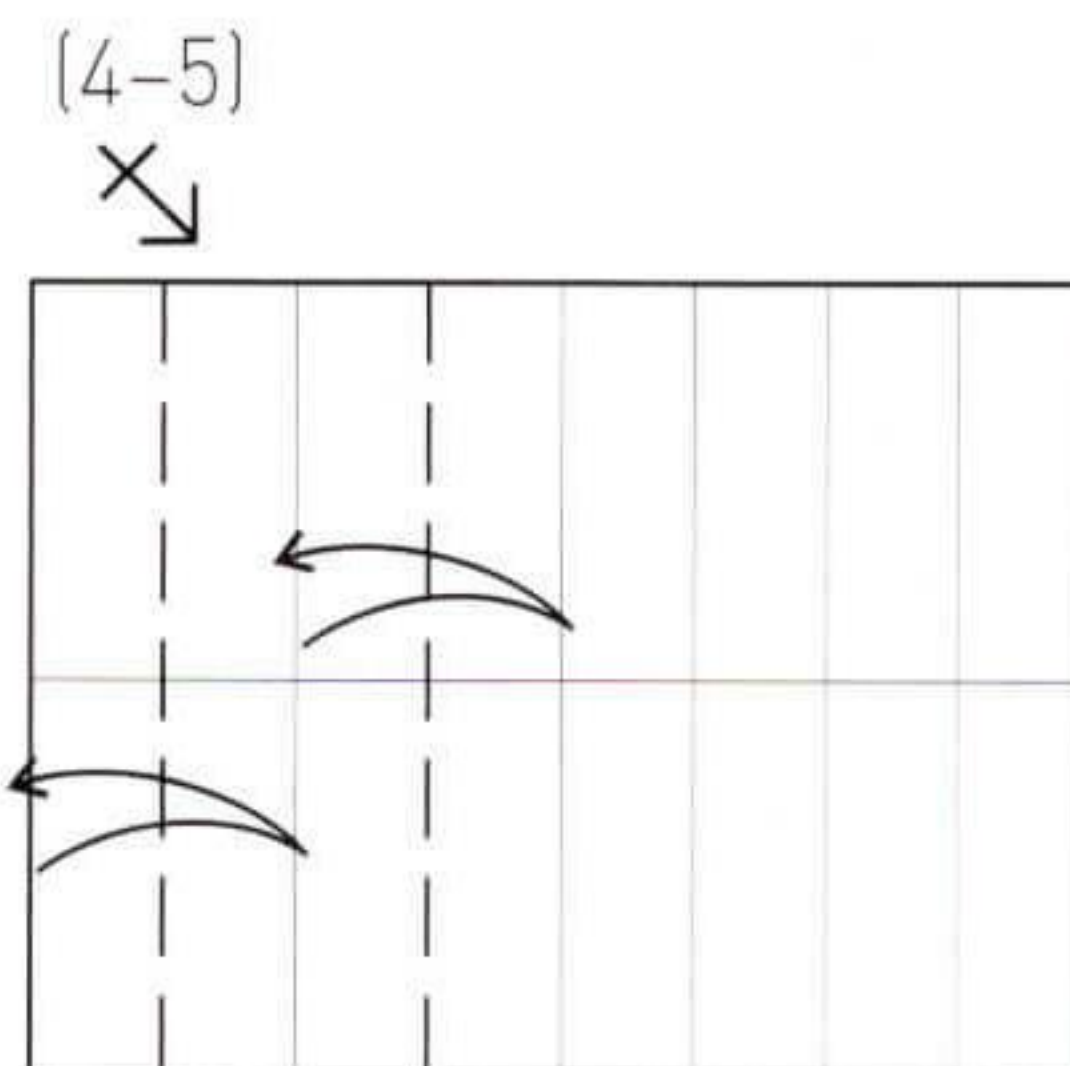

6 Repeat steps 4 to 5 on the other edge of the paper.

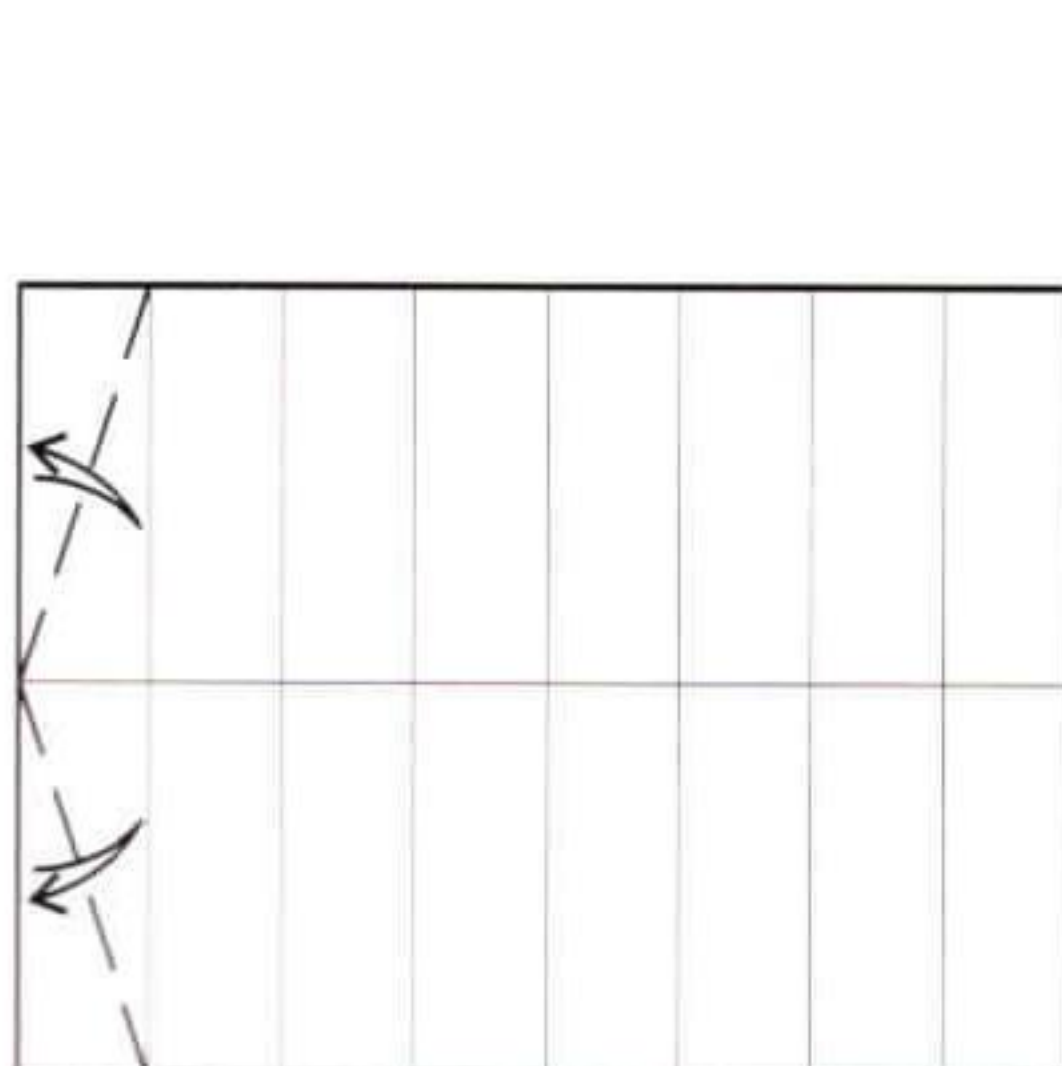

7 Fold and unfold diagonally, across the space defined by the creases.

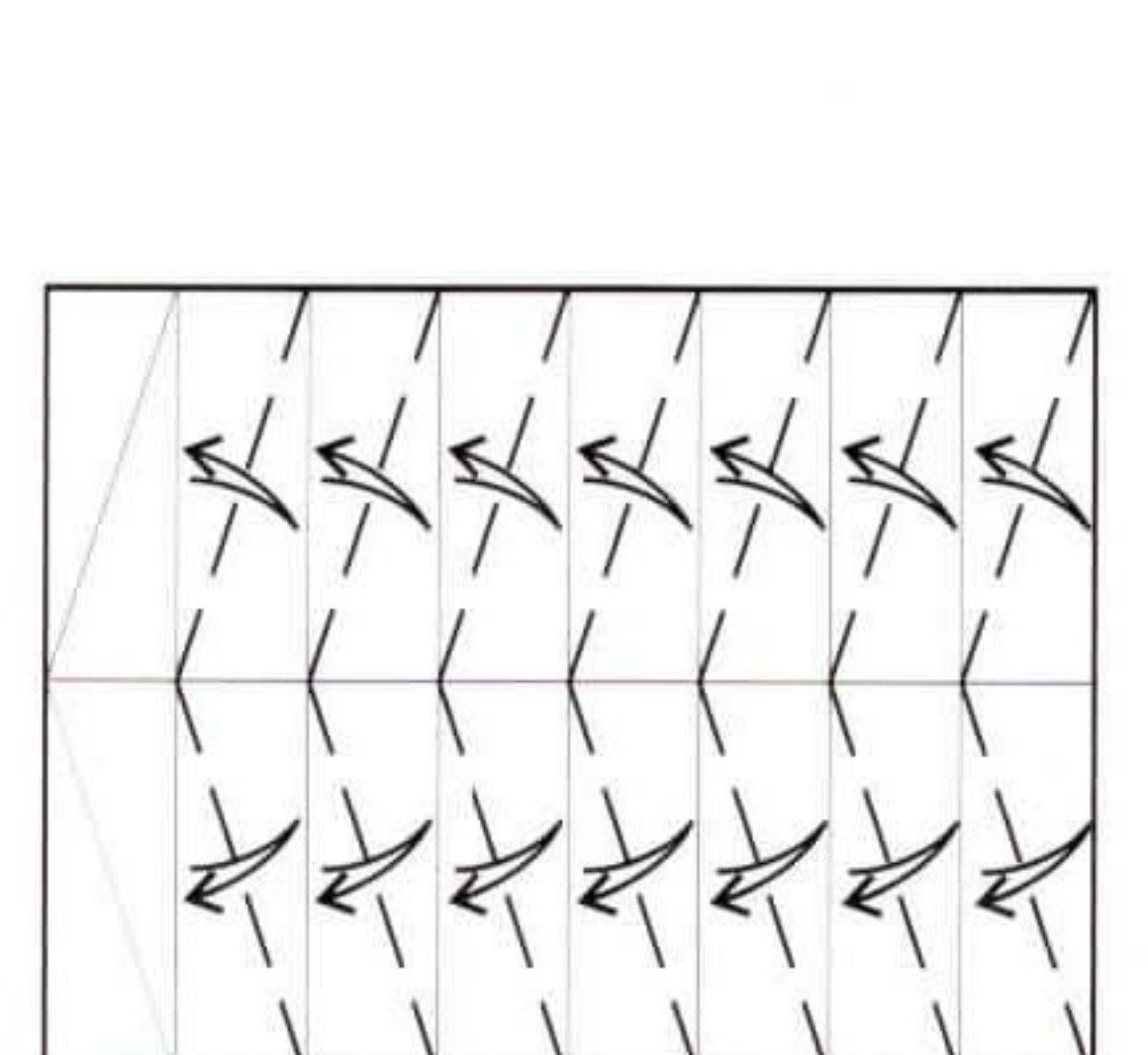

8 Repeat this process along the rest of the paper.

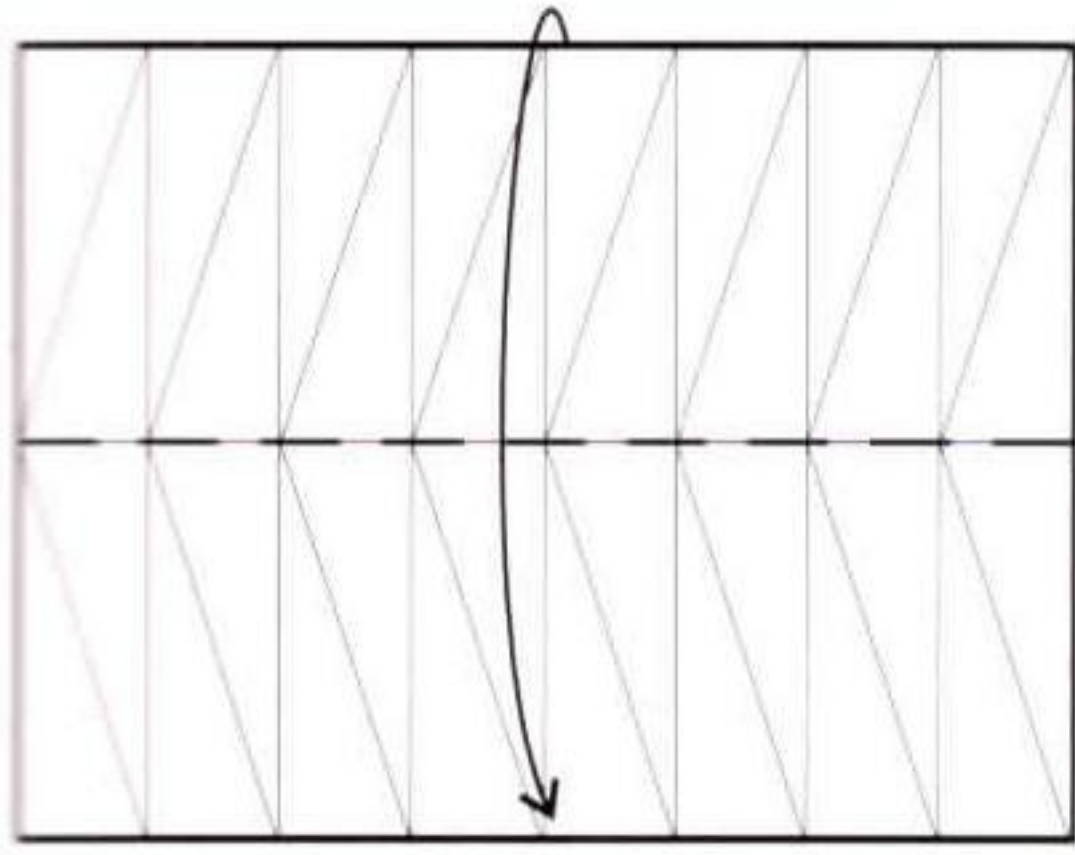

- 9 Fold the paper in half lengthwise, so the upper edge touches the lower edge.

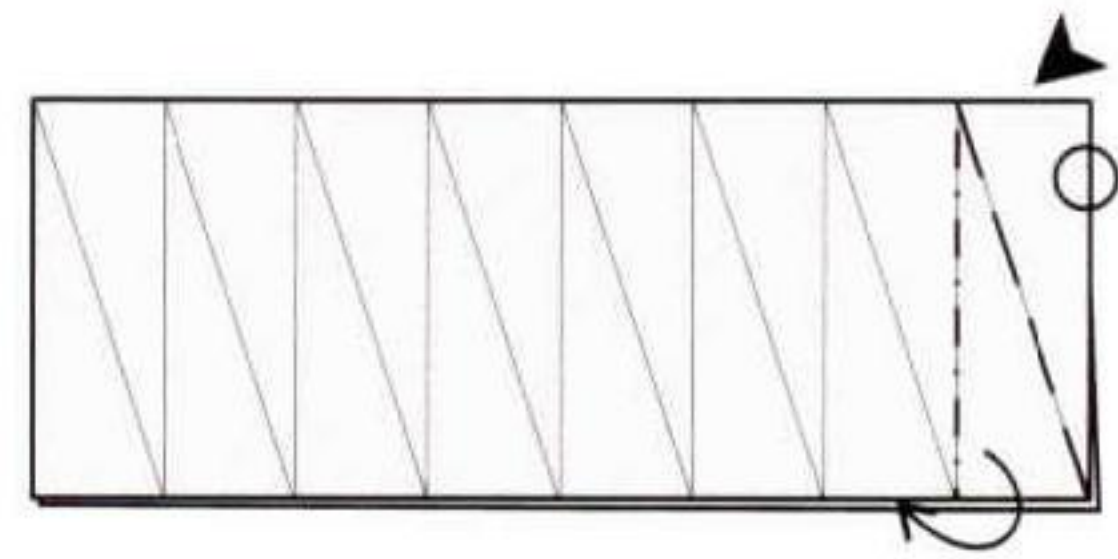

- 10 Hold the outer edge of the model and fold the corner into the model along the creases made previously.

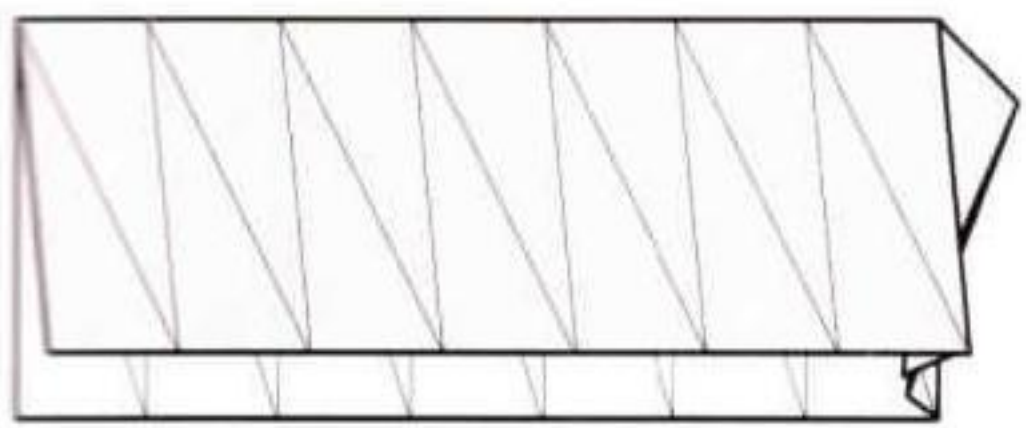

- 11 This shows the fold in progress. Note that the crimp fold takes the corner inside the model.

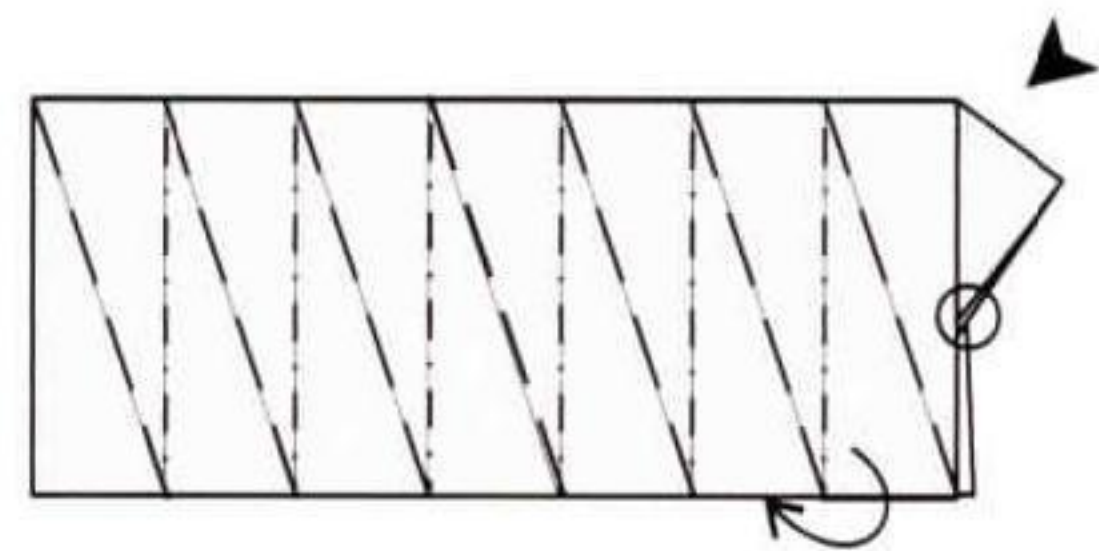

- 12 Repeat this process on the adjacent creases.

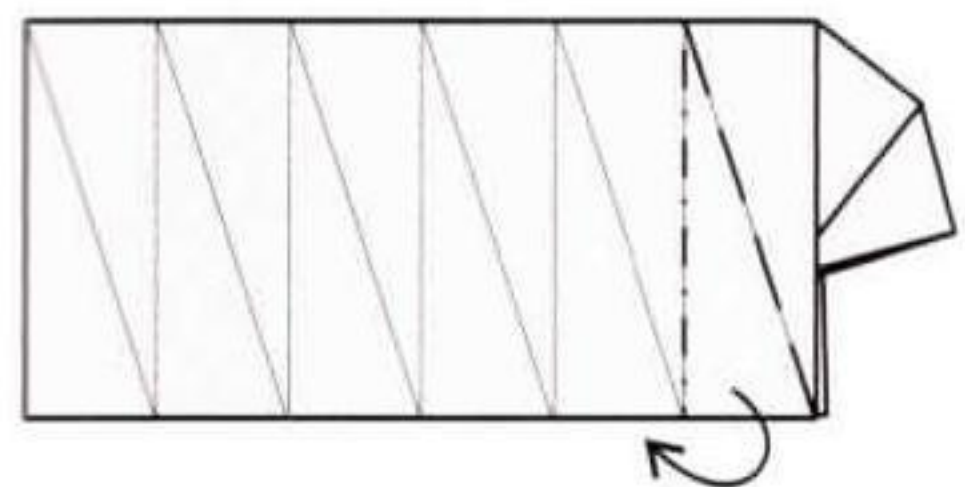

- 13 Continue this process and start to roll the paper around as you go.

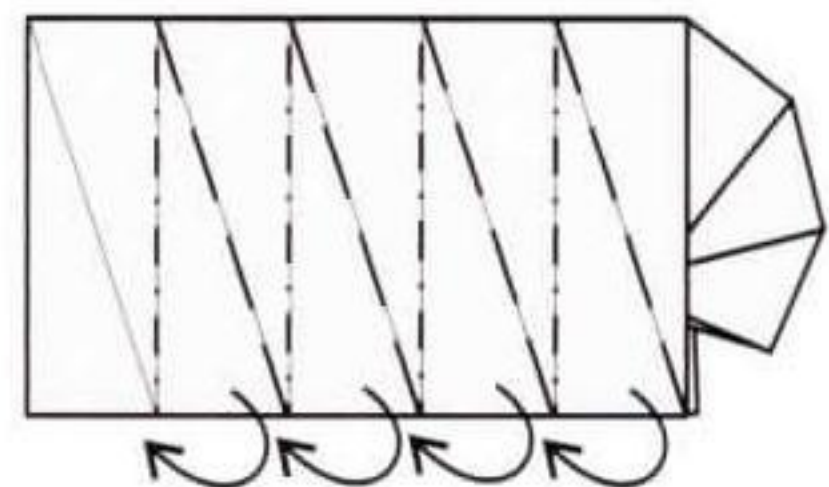

- 14 Complete the crimping process for the rest of the model.

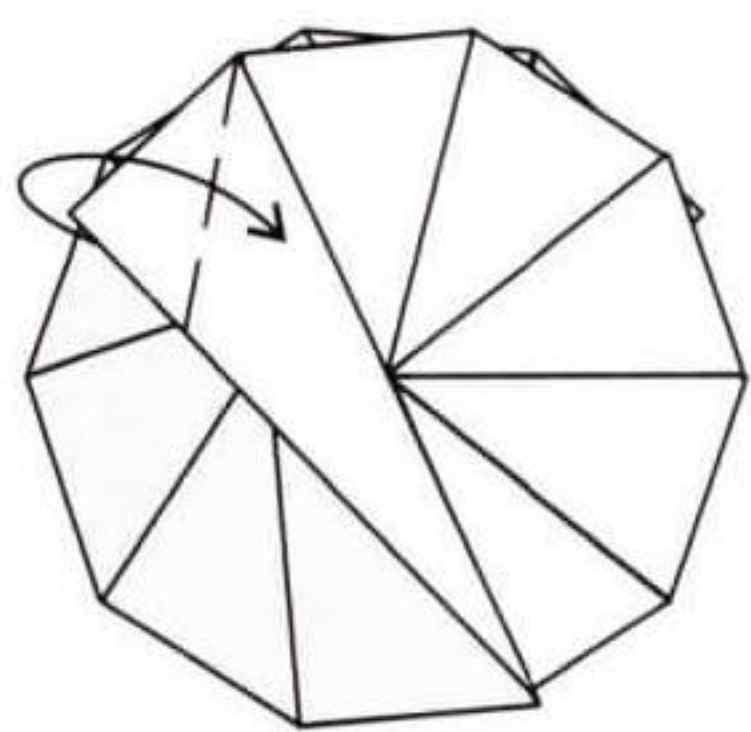

- 15 The crimping process is complete. Now fold over the corner of the last section.

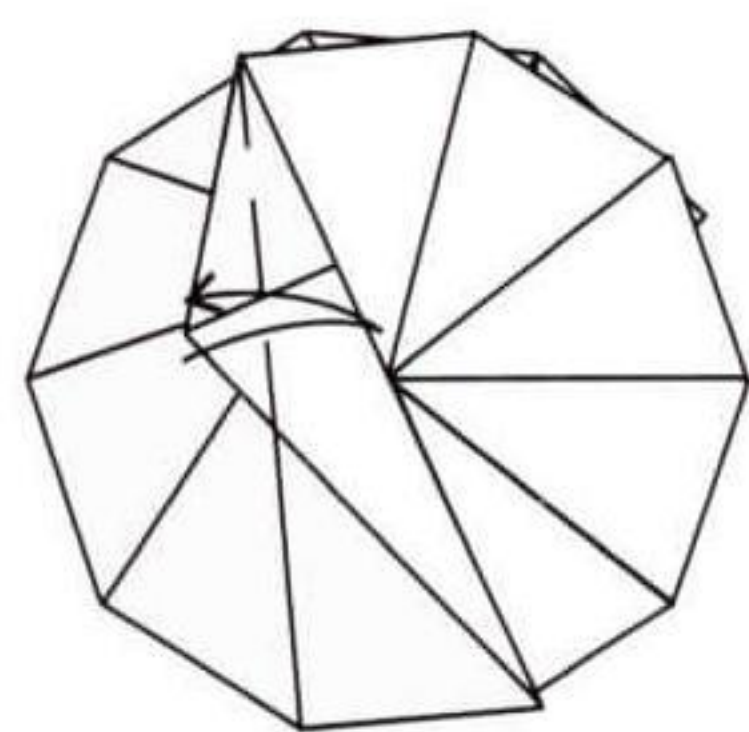

- 16 Fold and unfold the corner aligned with the folded edge beneath.

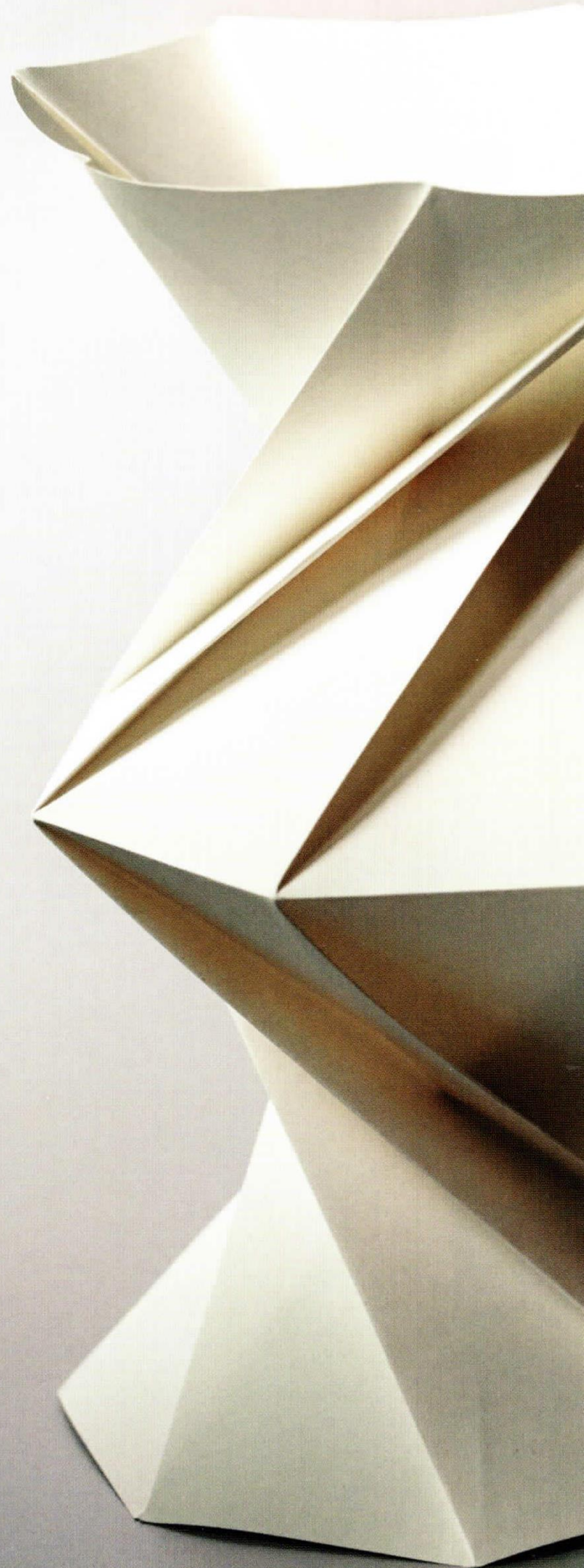

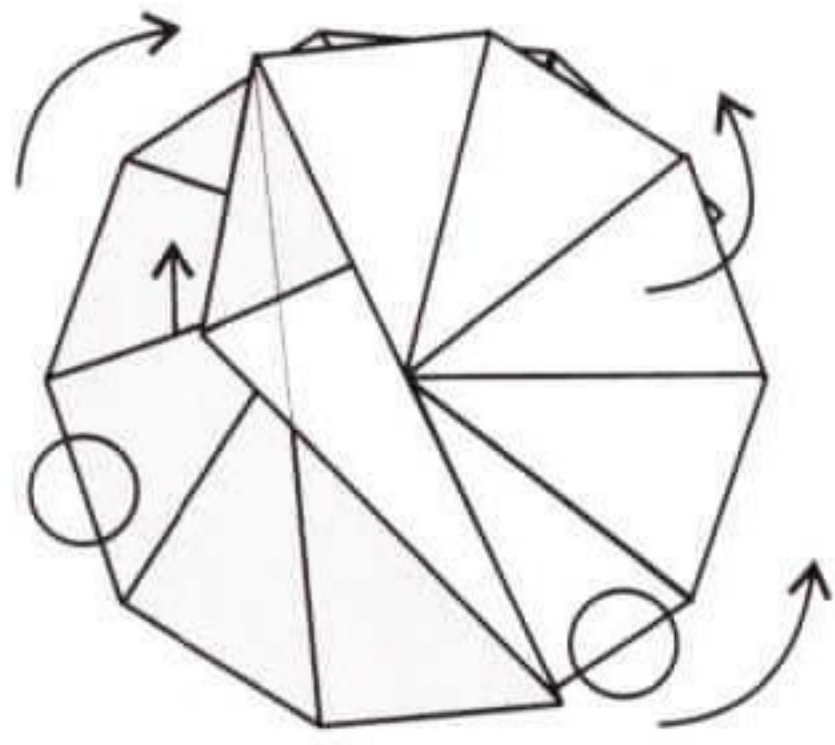

17 Now open out the model, by holding the sides at the Os and opening out. The aim is to pull out the trapped corners and slide them outside.

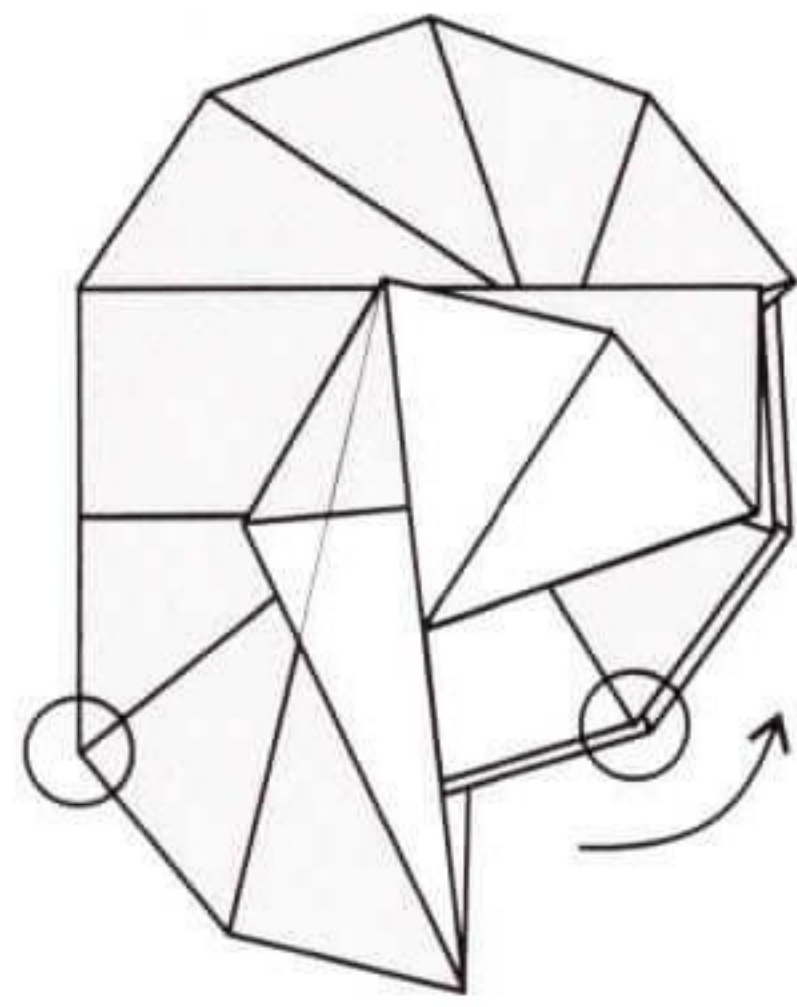

18 Continue opening the model.

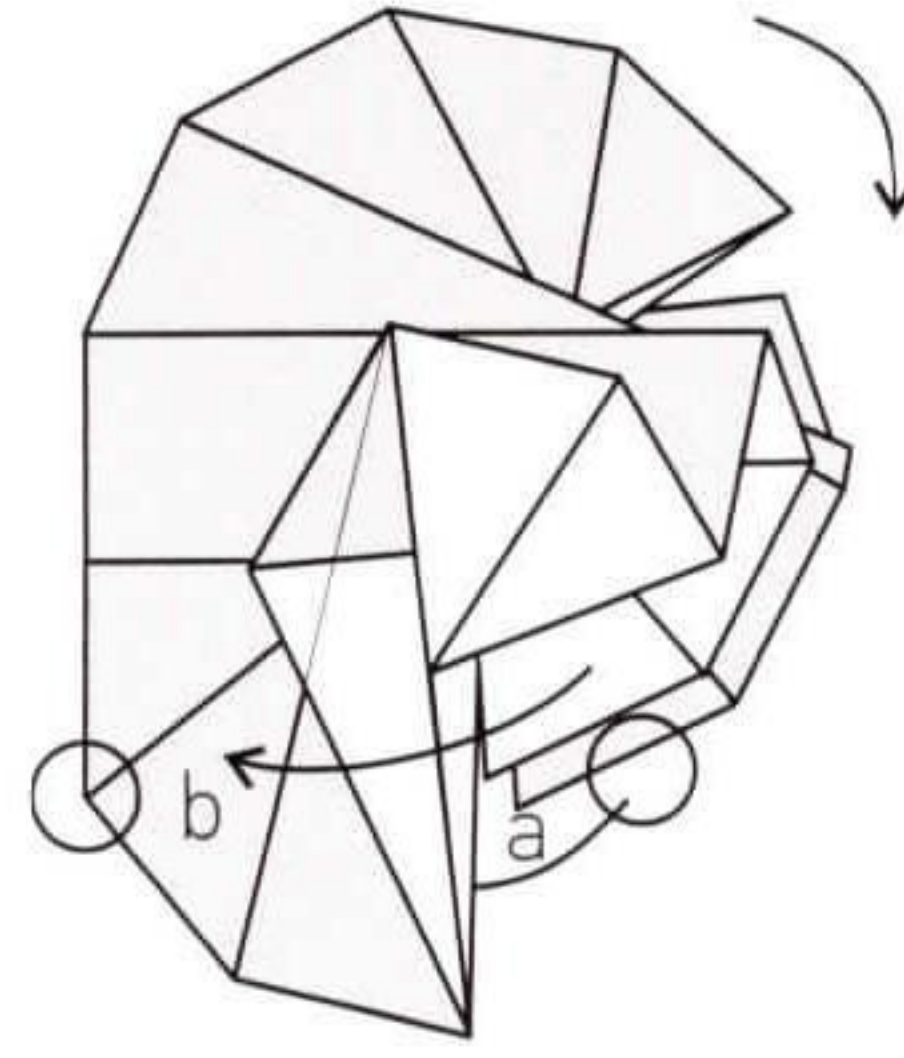

19 Now fold the model back together, but fold the corners (a) over the outer layers (b).

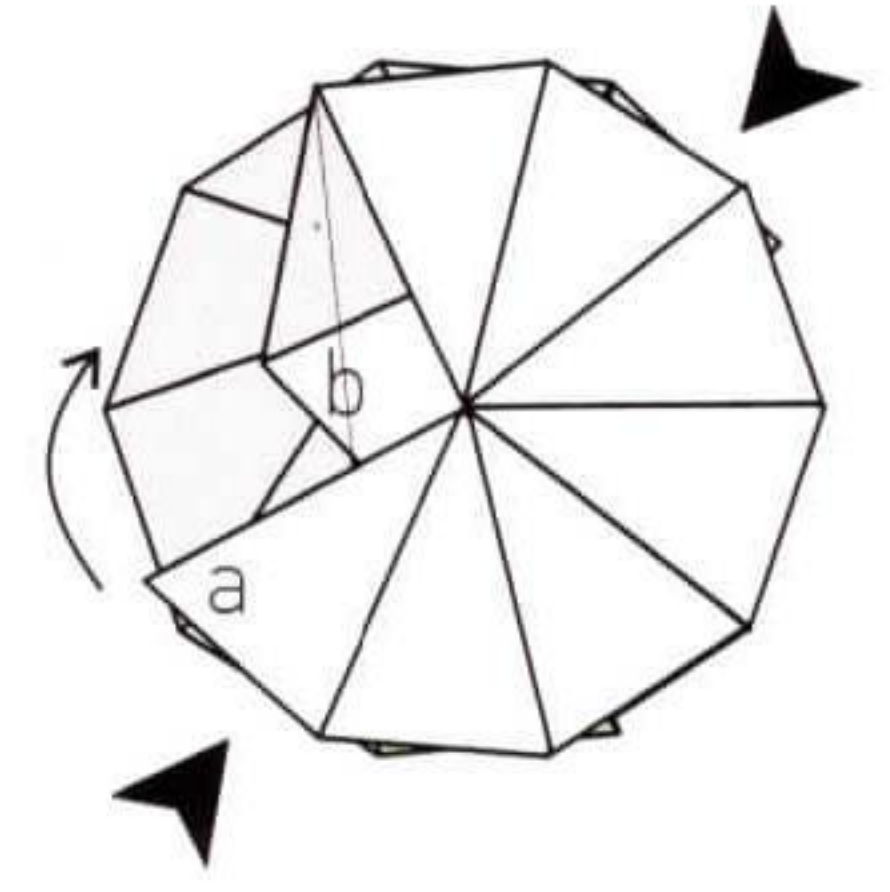

20 Push the sides of the model together. This will extend the model and push the edges (a) and (b) together. The next step will show a side view of the model.

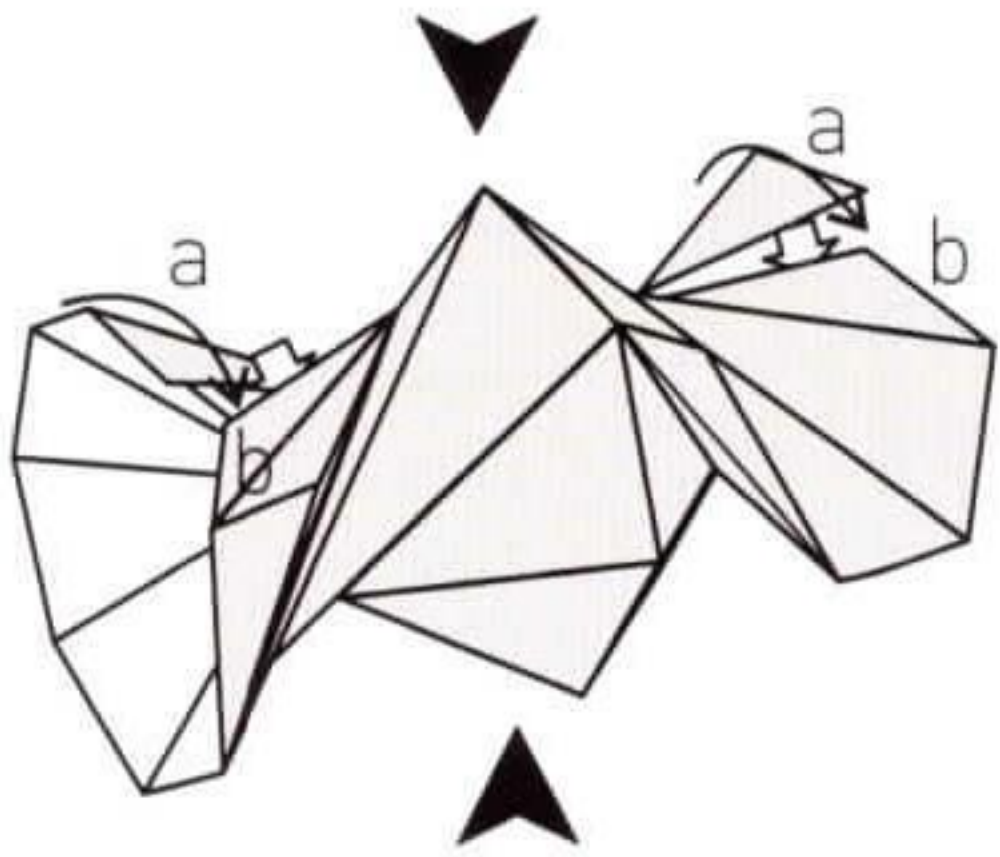

21 Continue pushing the body together and tuck the outer edges into (a) under the adjacent edge (b) at both ends.

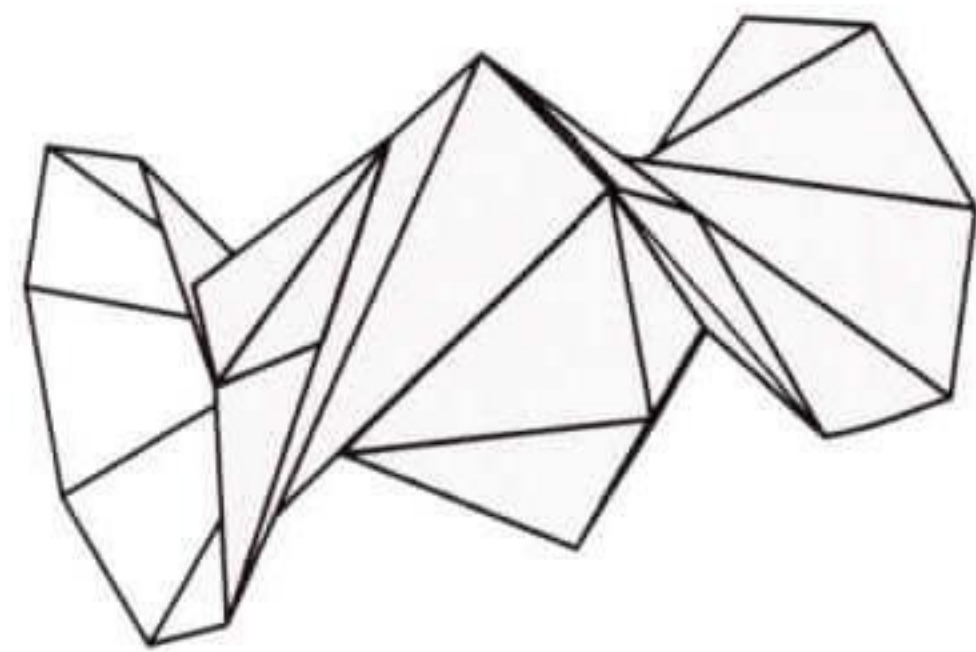

22 Rotate the model so it stands on one end.

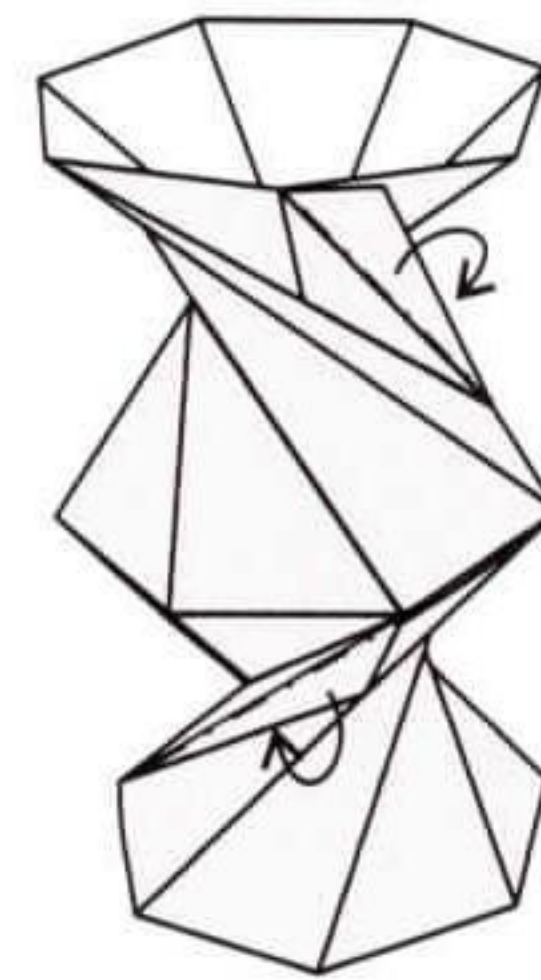

23 With the ends aligned, fold over the crease made in step 16 to link two layers together. Repeat this on the lower section.

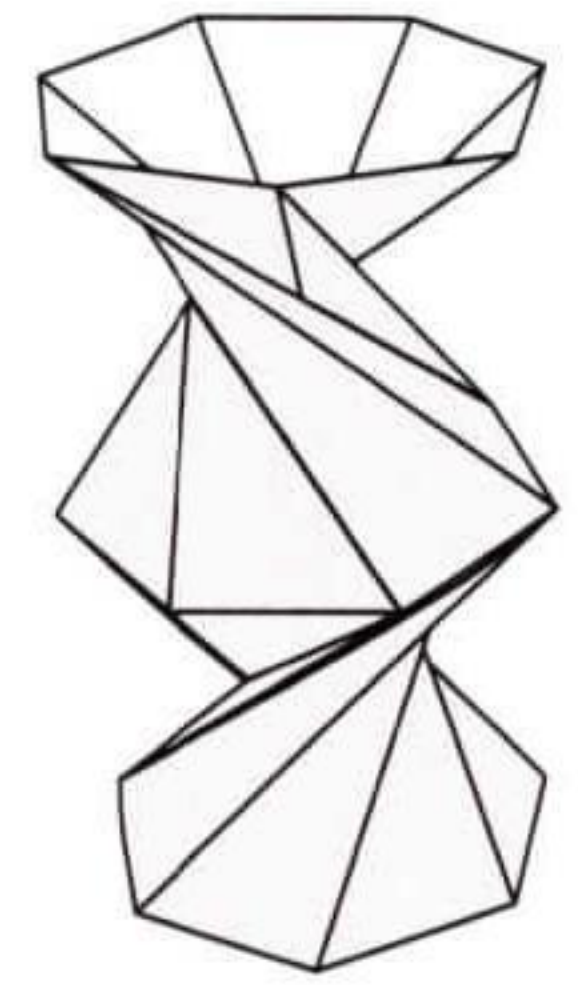

24 Complete.

OPENING UP THE MODEL



20

This photo shows a side view of the two sides being pushed together.

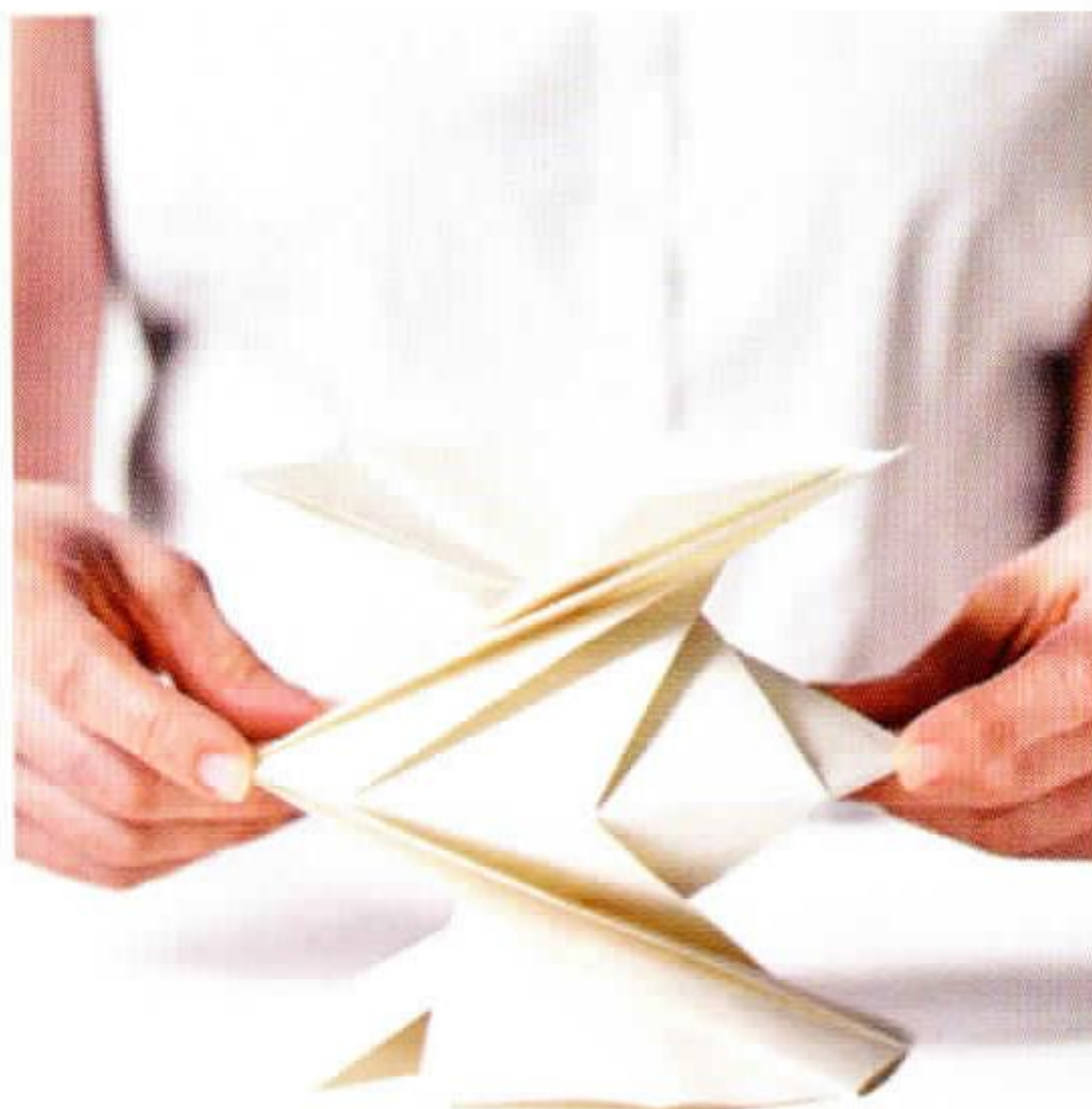

21

Continue pushing the sides and extending the model.

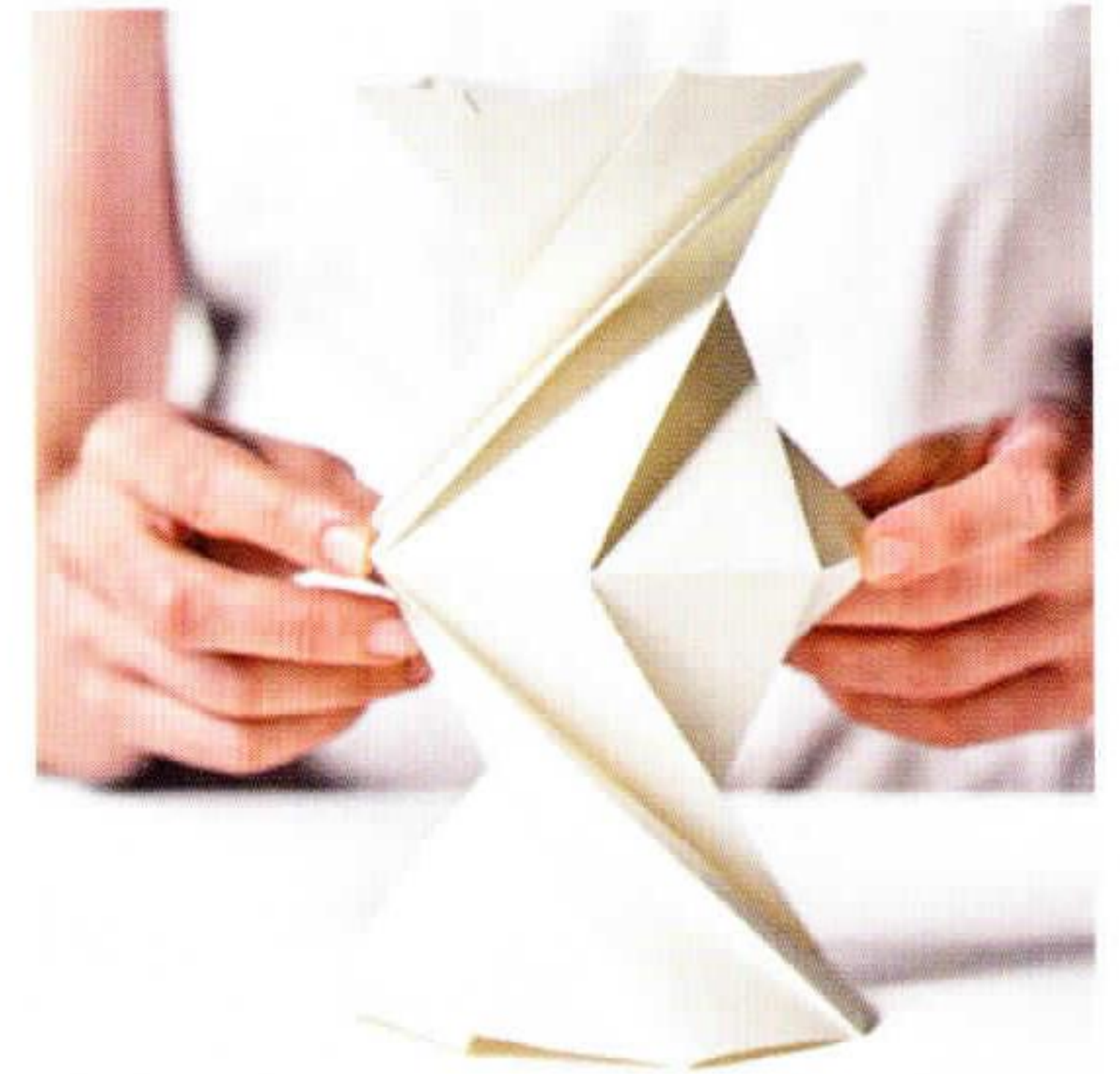

22

The two sides should fit together in preparation to lock them together by folding the corners over in step 23.

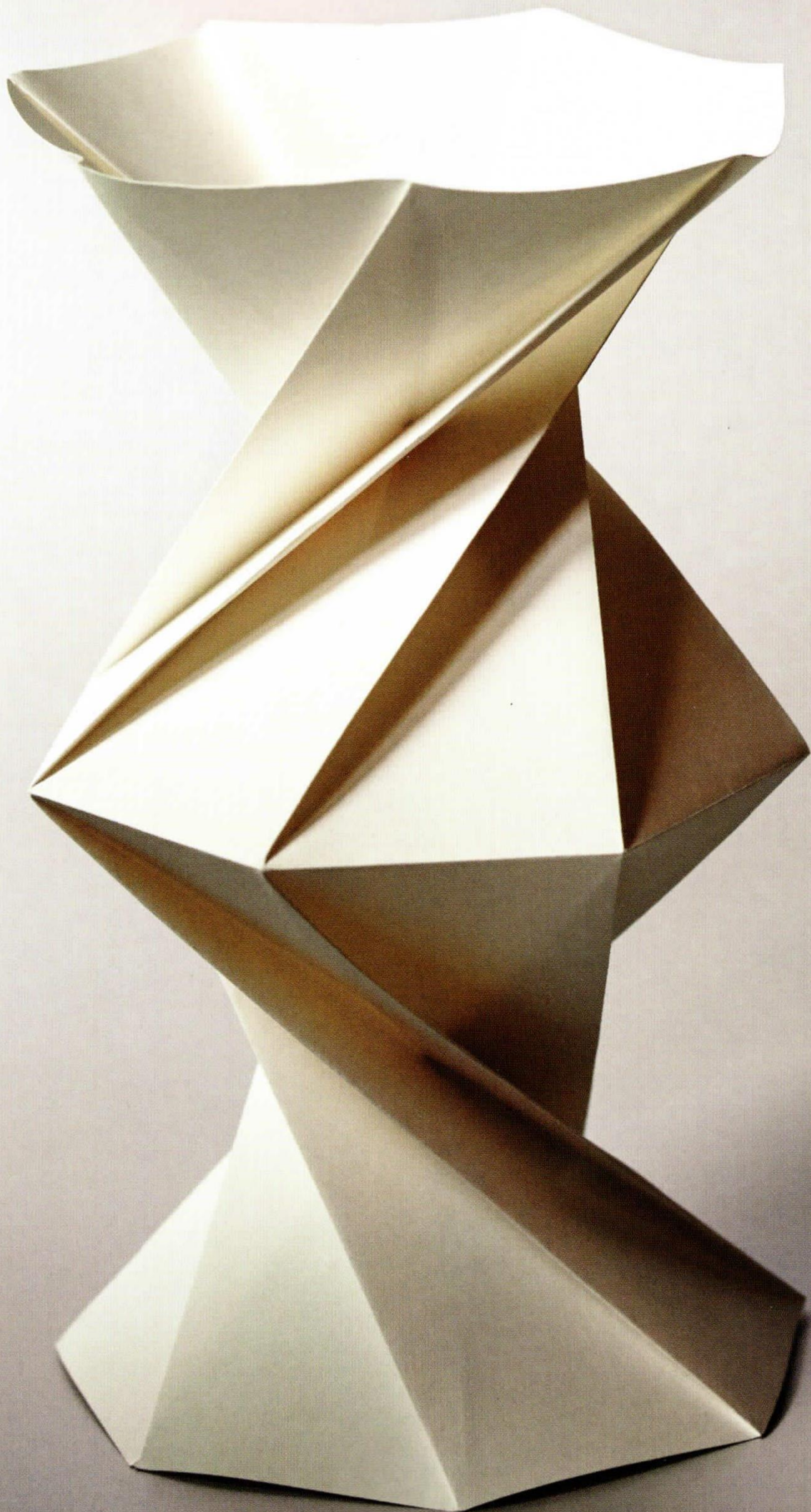

DNA Wheel

**

The DNA wheel fold builds a spiral similar to a natural DNA structure. Within the folding process the model has a fluidity. The opposite sides of the square twist, turning one side over until the ends of the wheel tuck into each other, locking them together.

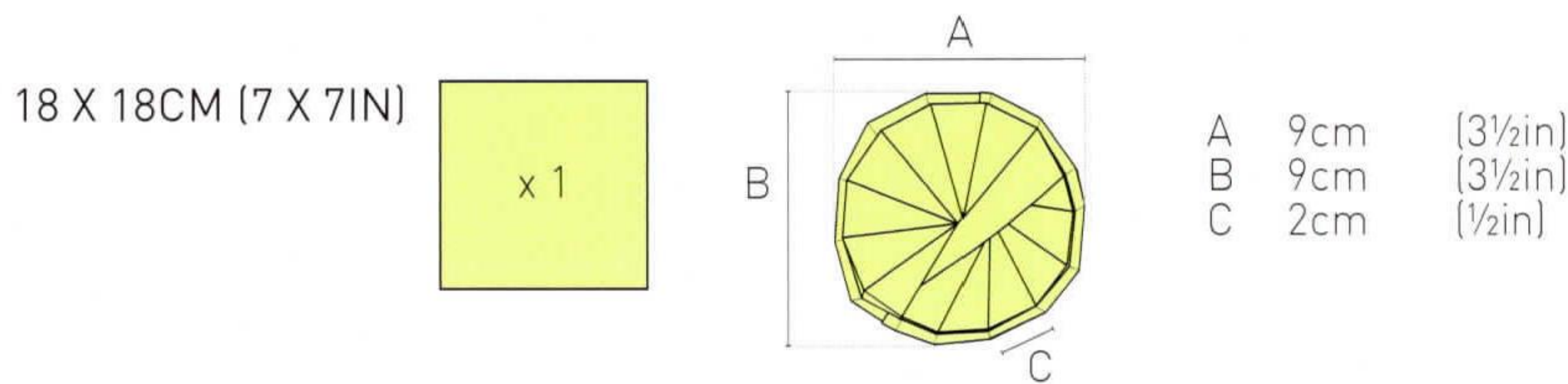

START WITH A SQUARE, COLOURED SIDE UP.

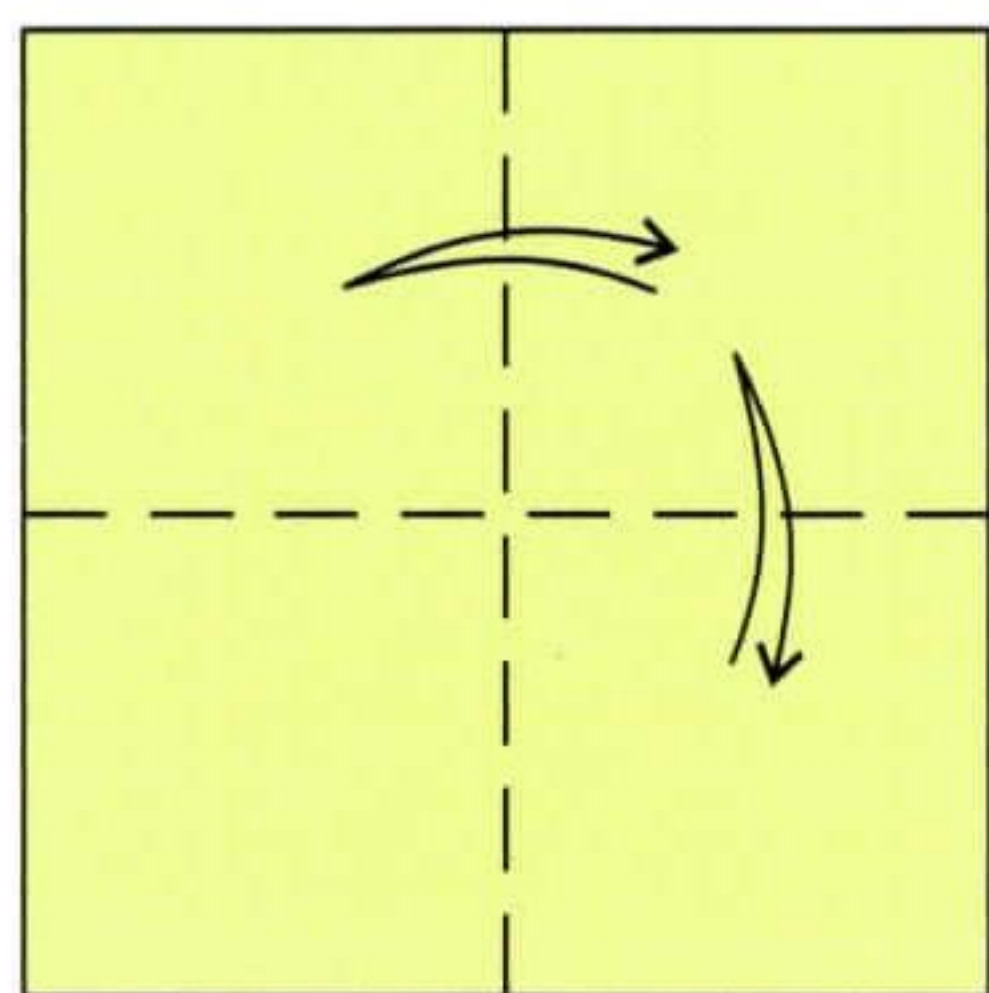

1 Fold and unfold the square in half lengthwise.

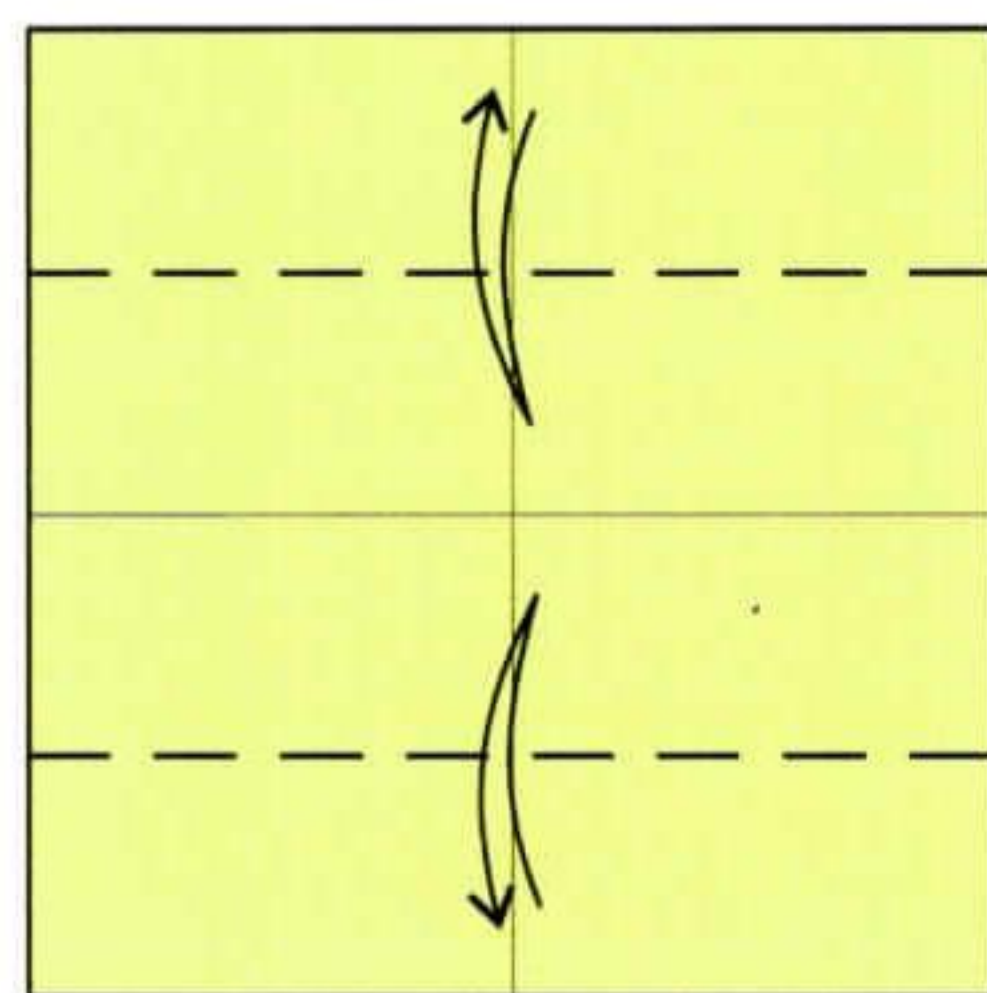

2 Fold the edges to touch the middle crease and unfold.

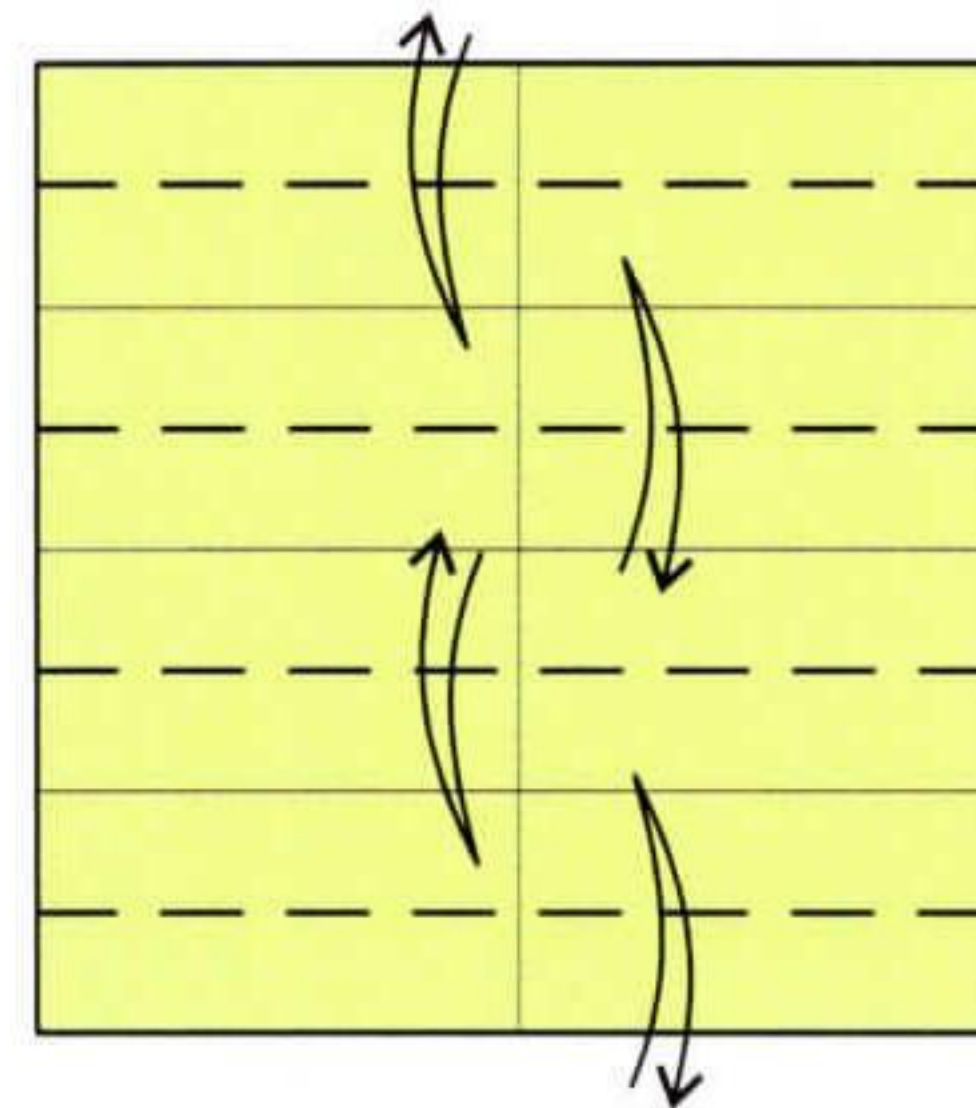

3 Fold and unfold between the creases to divide the paper into eight sections.

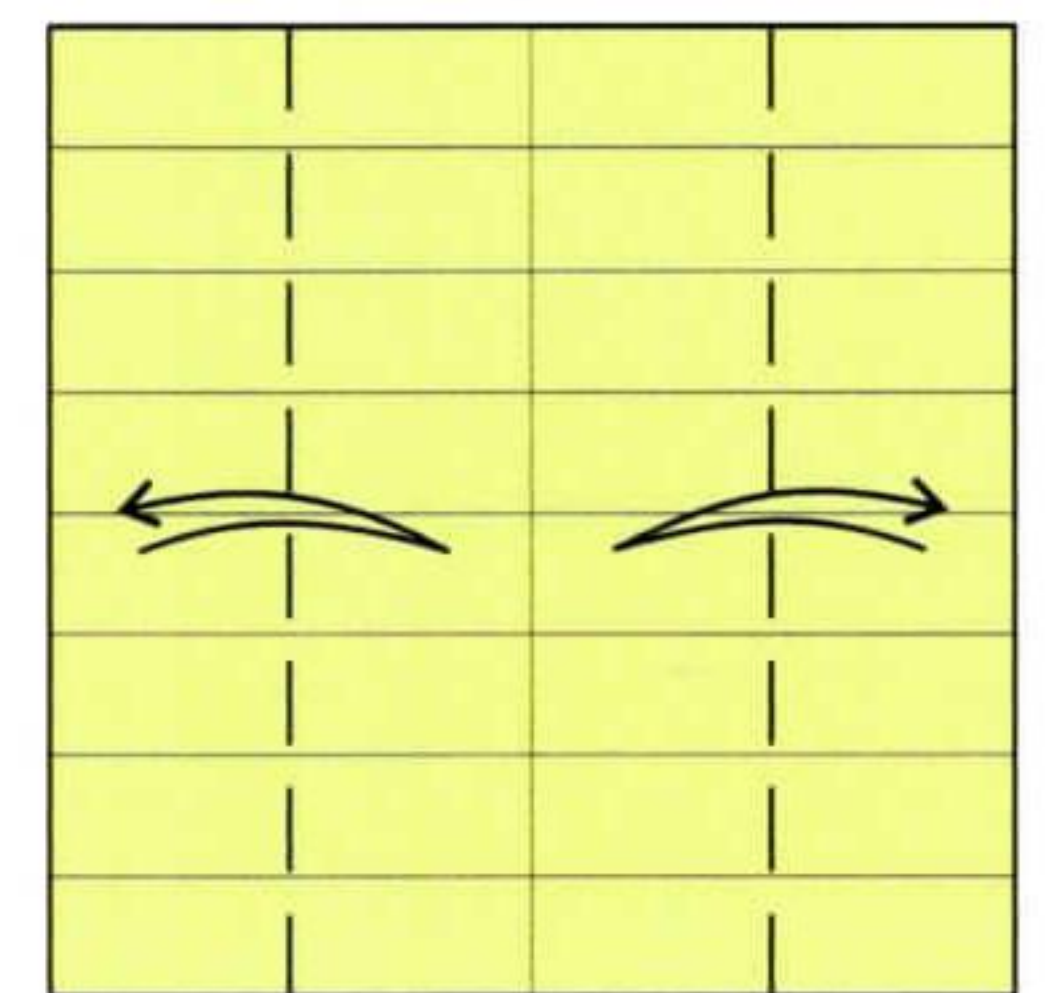

4 Fold and unfold the side edges in to touch the middle crease.

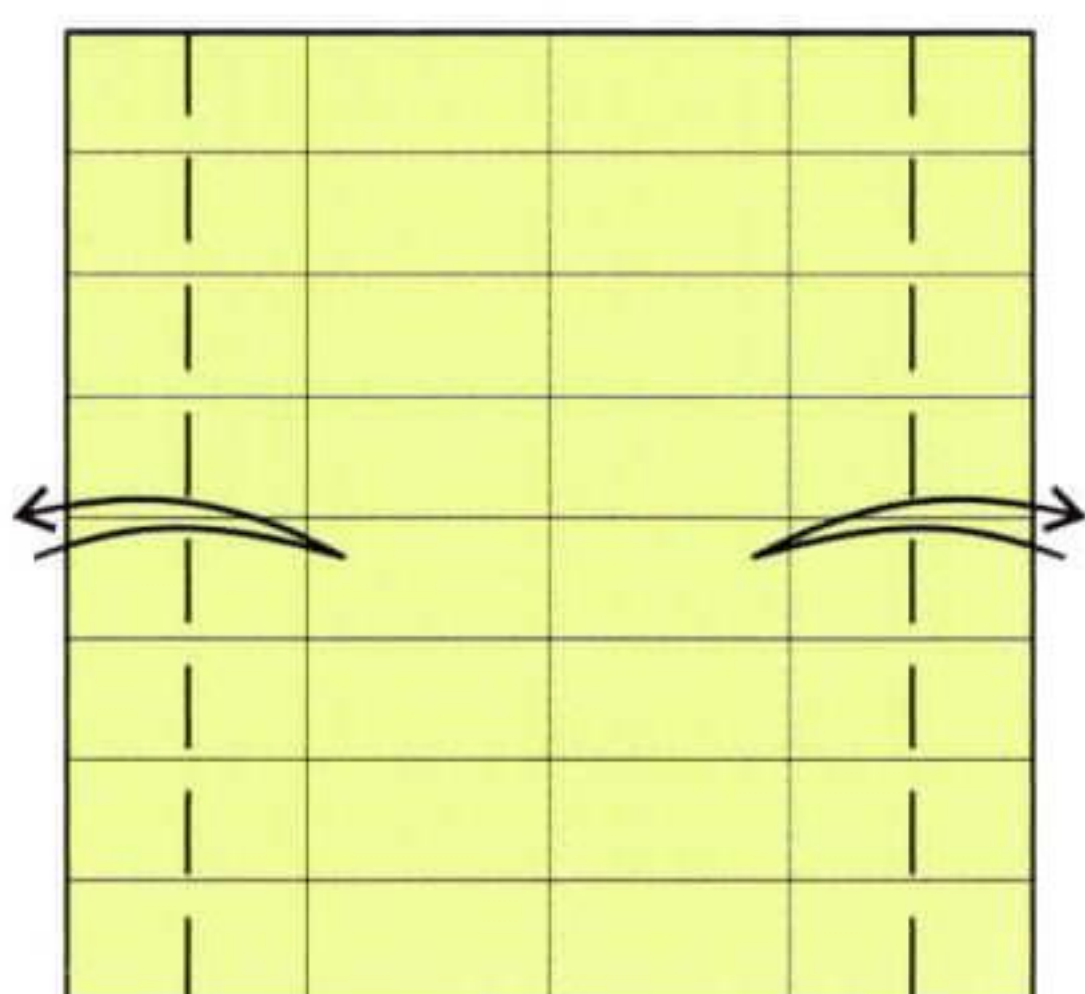

5 Fold and unfold the edges in to the adjacent creases.

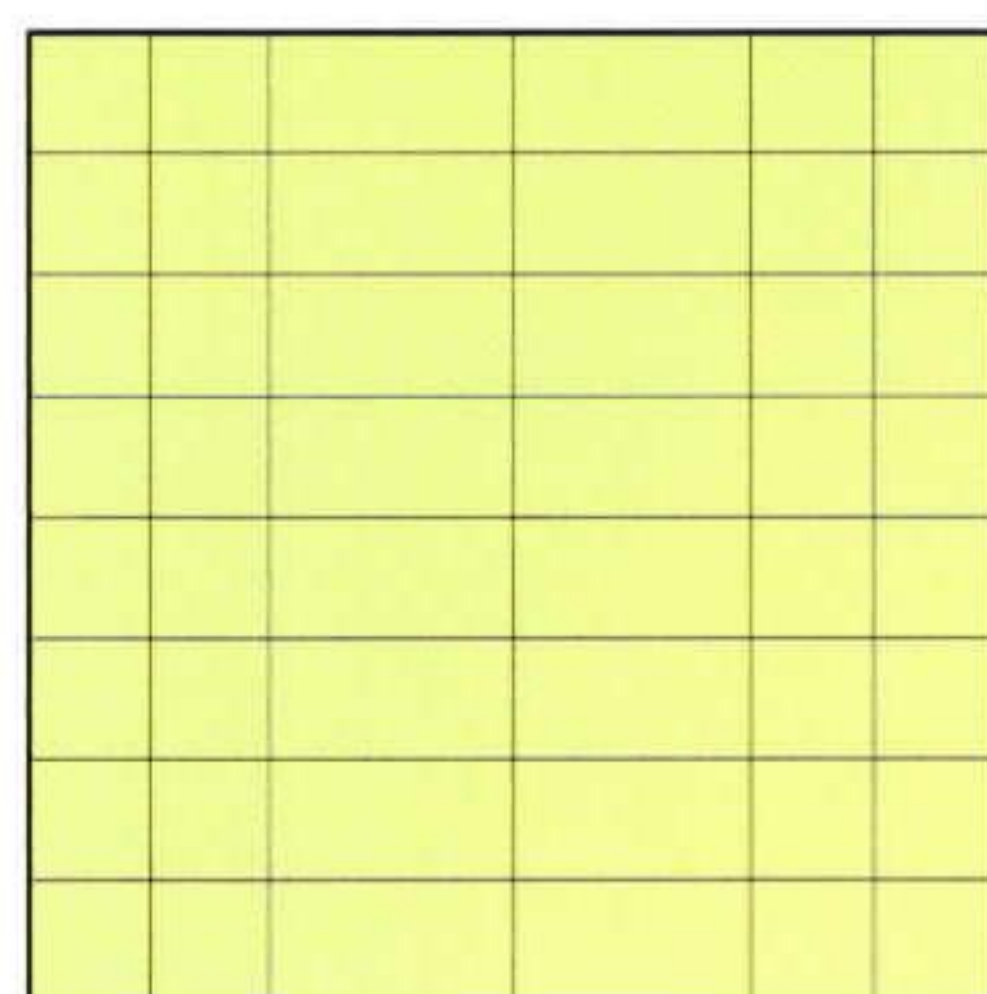

6 Turn the model over left to right.

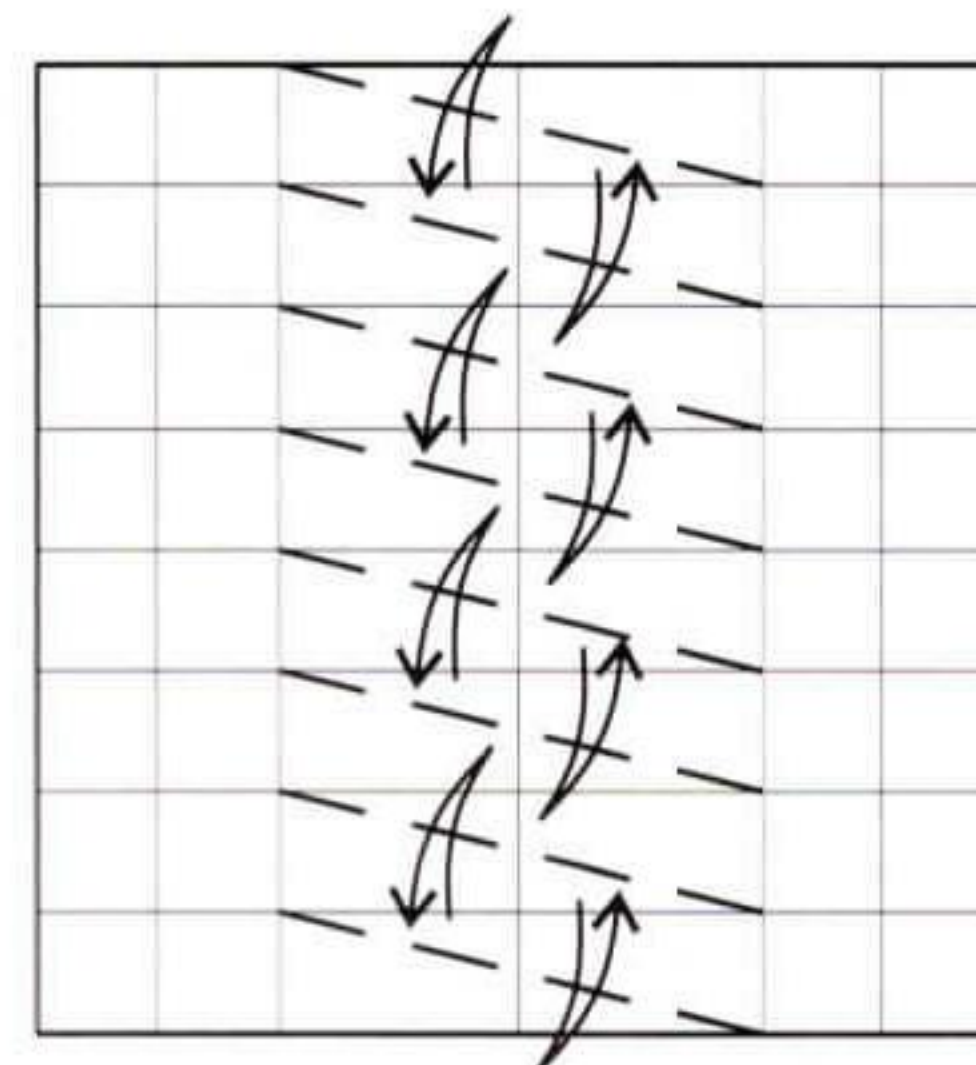

7 Make a series of diagonal folds between the creases made previously.

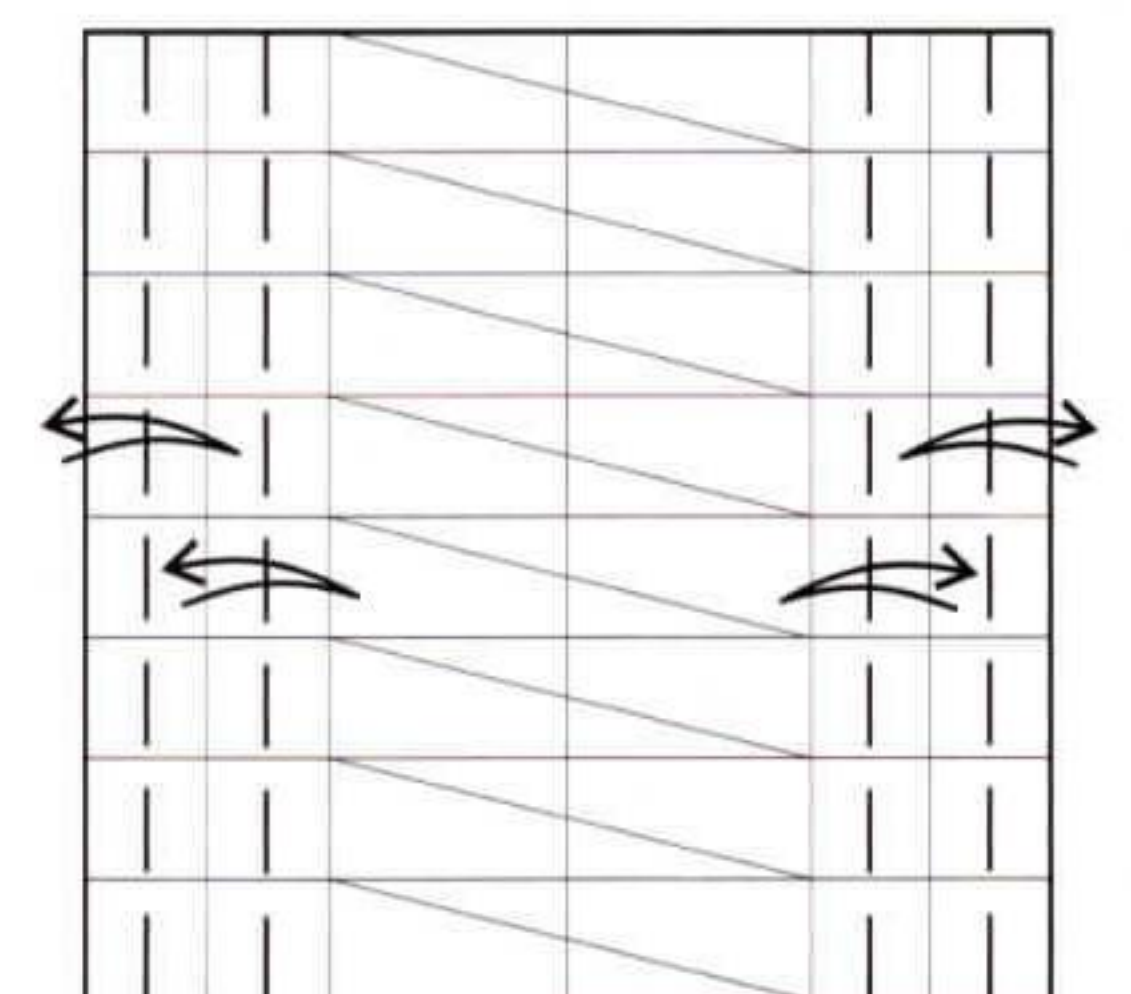

8 Fold and unfold between the creases made previously, dividing each outer side into four sections.

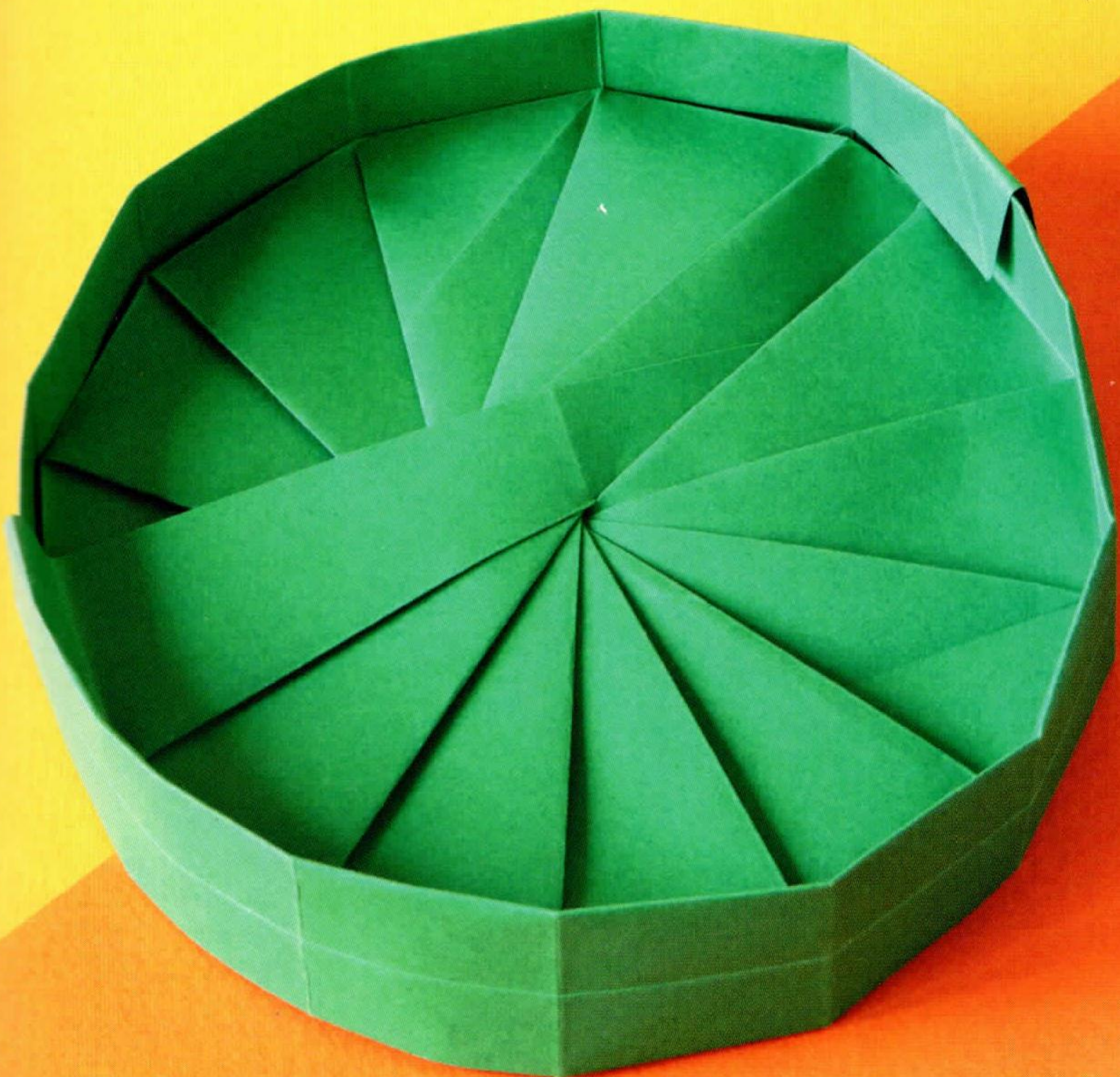
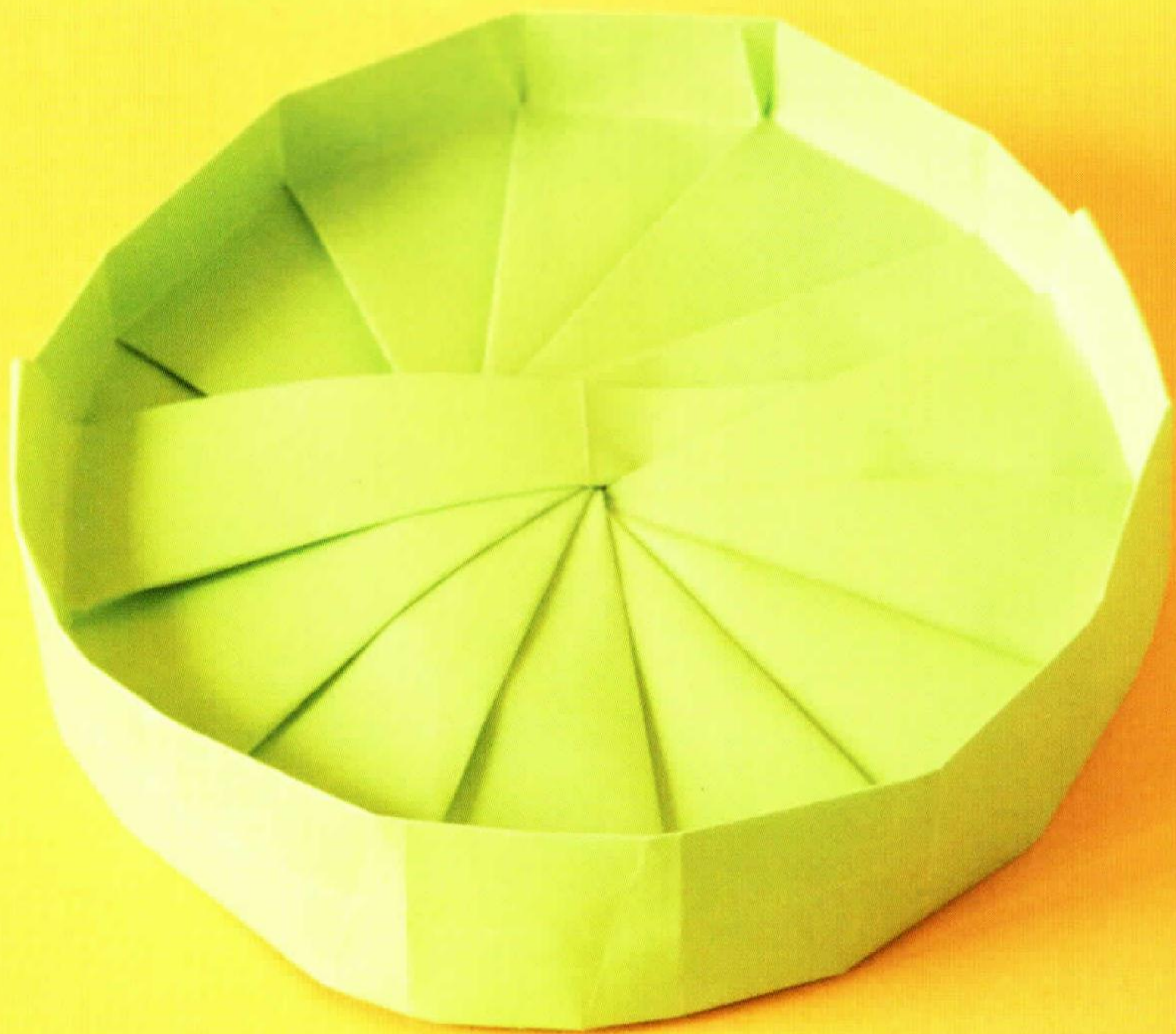

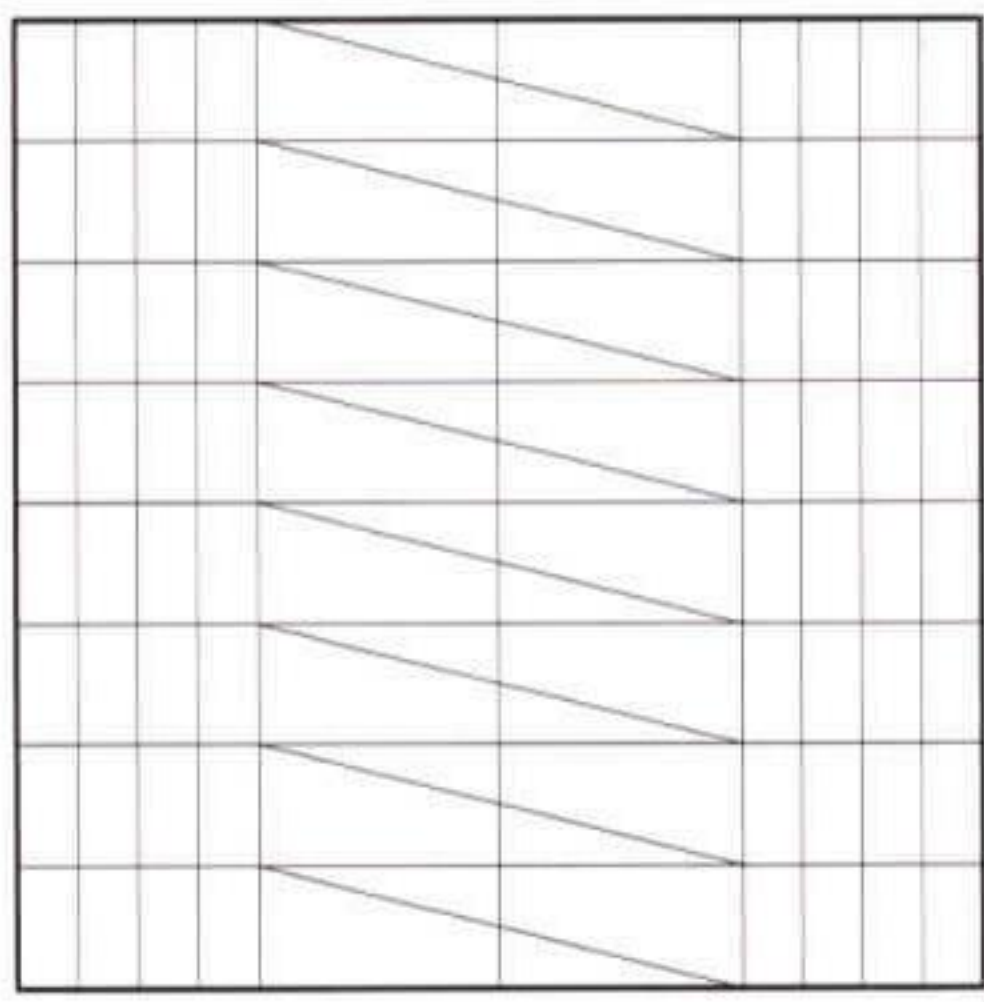

9 Turn the model over left to right.

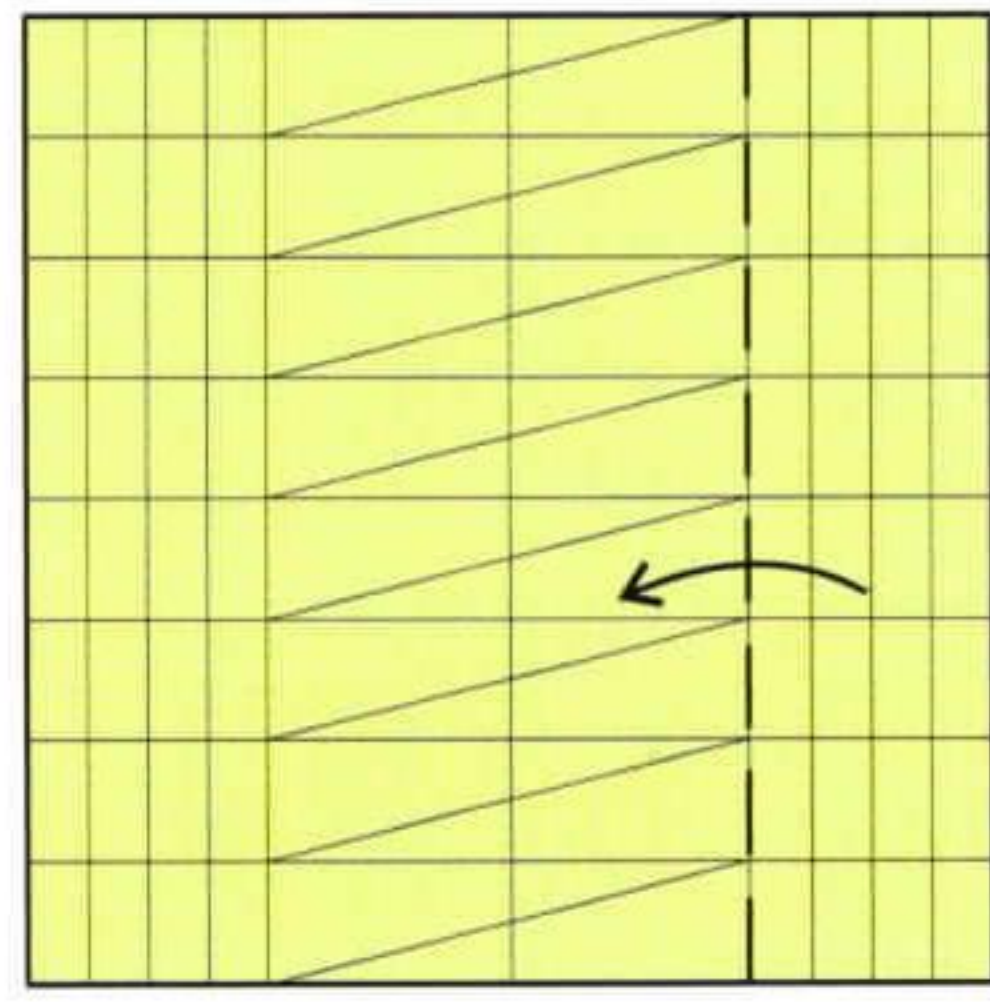

10 Fold the right edge into the middle.

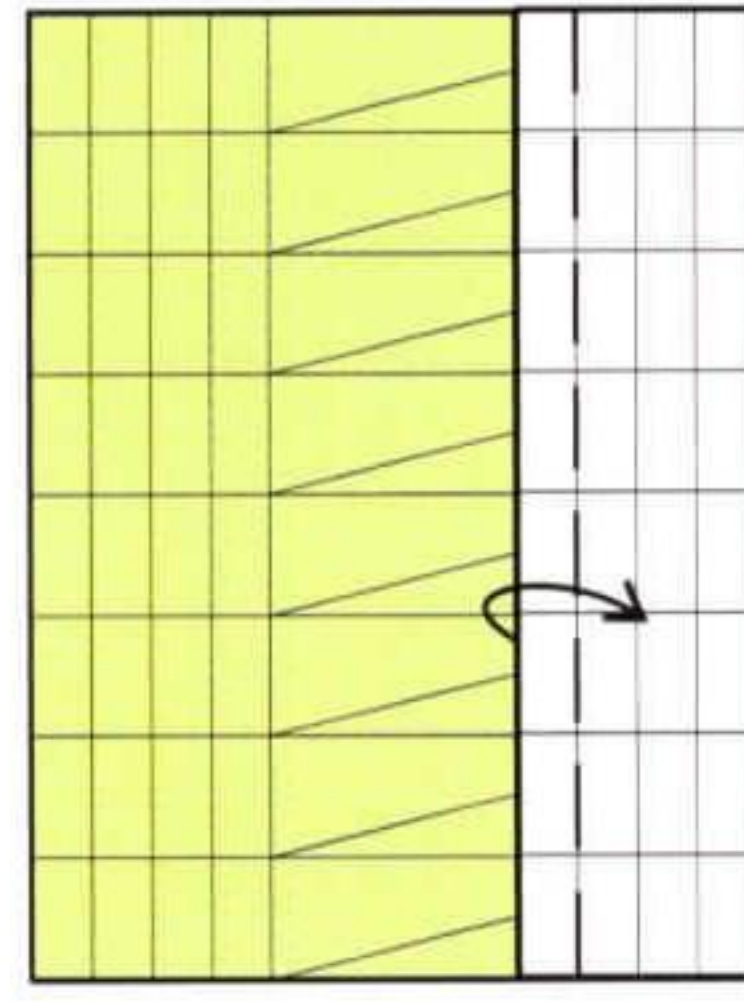

11 Fold the outer edge over along the crease made previously.

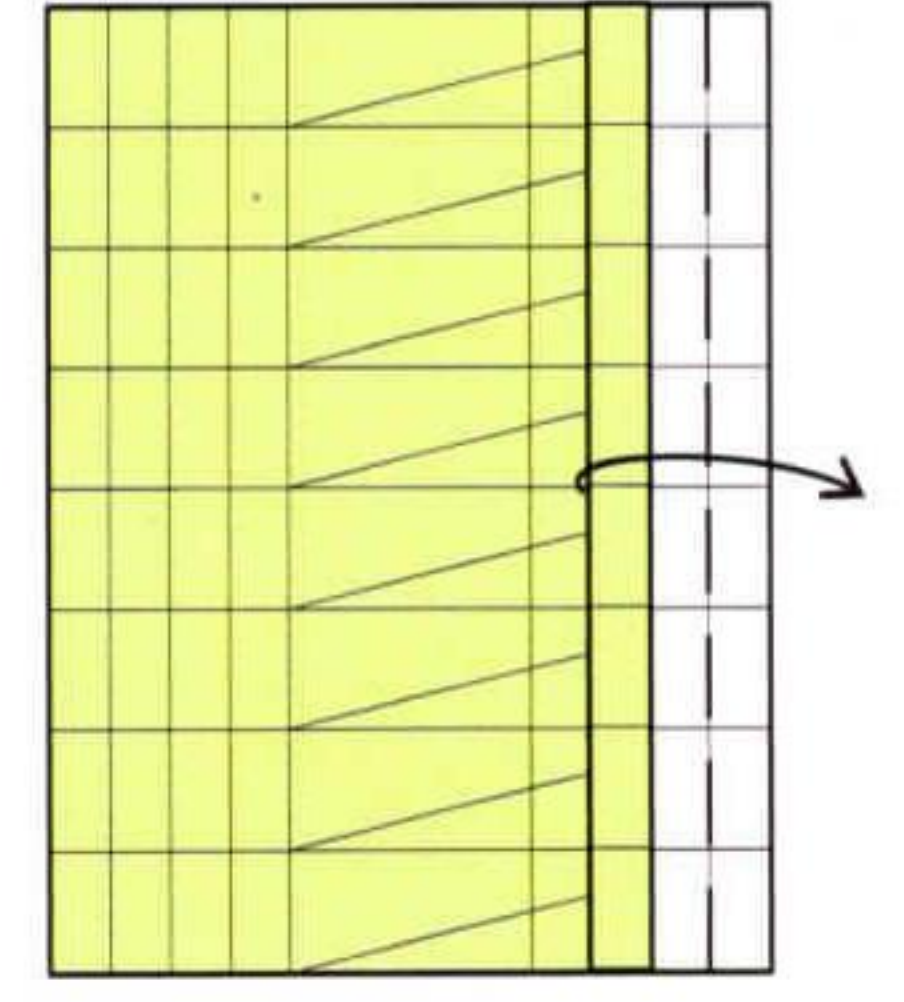

12 Fold the section back over to the right.

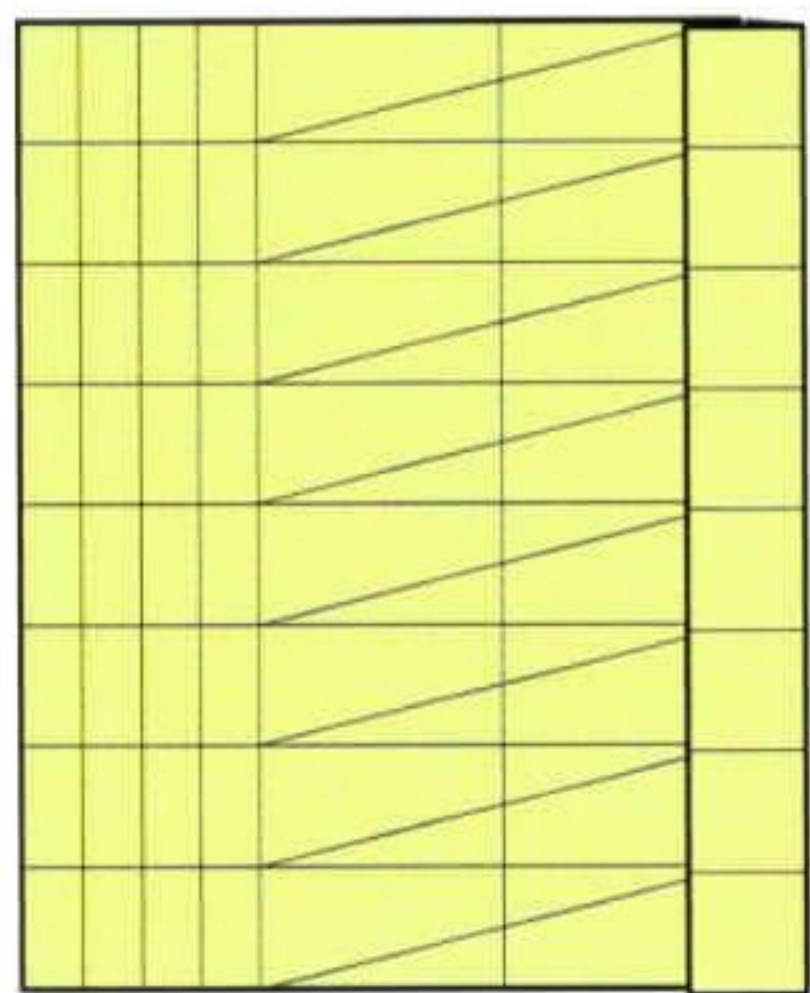

13 Turn the model over left to right.

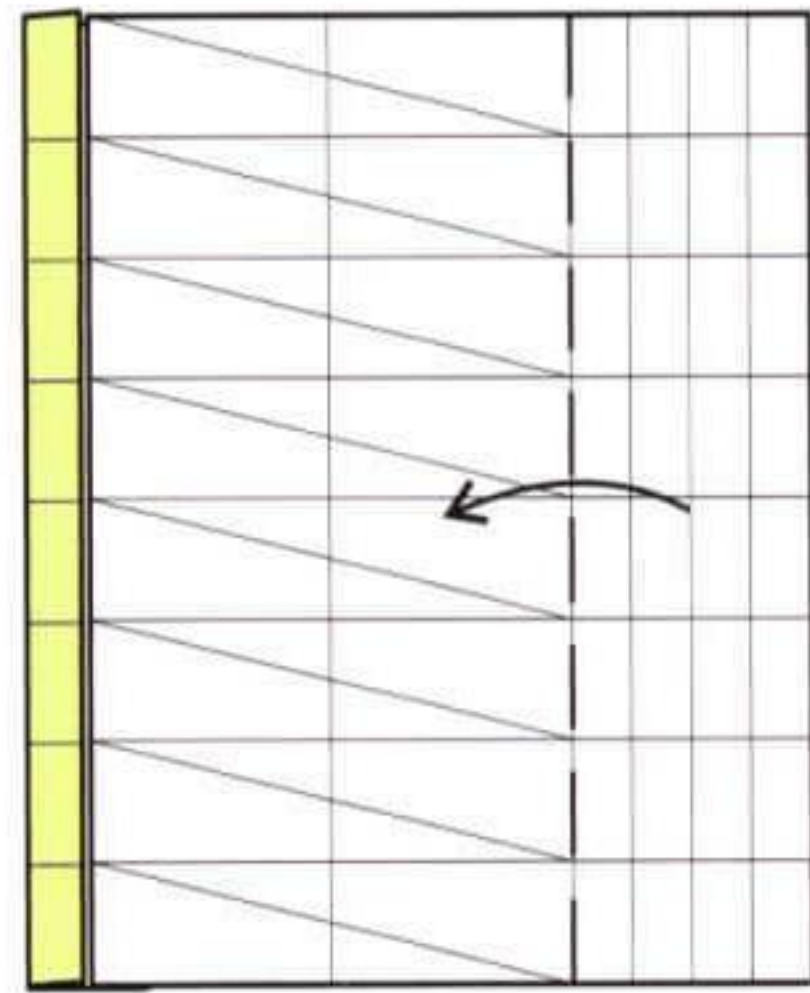

14 Fold the other side in to the middle.

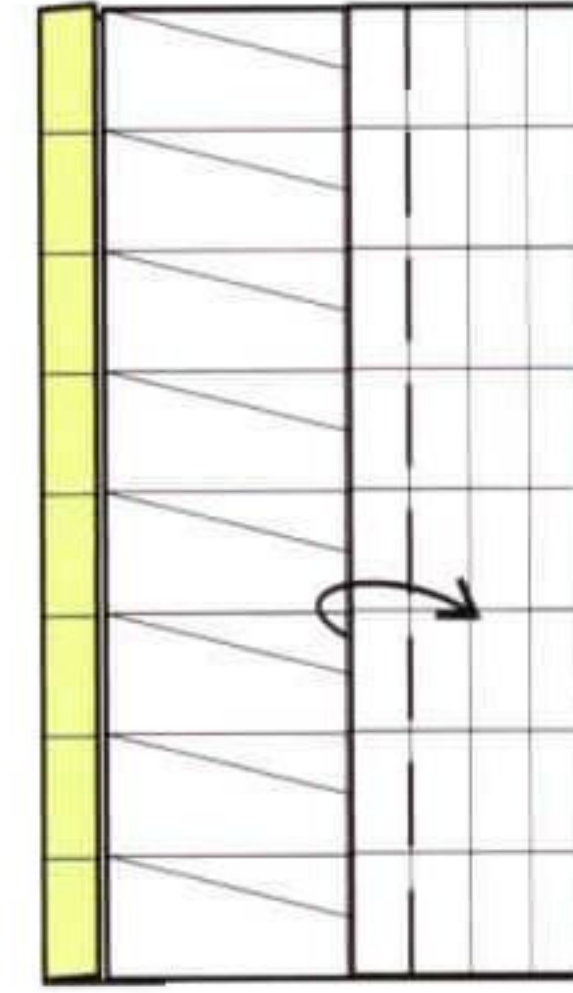

15 Fold the outer edge over.

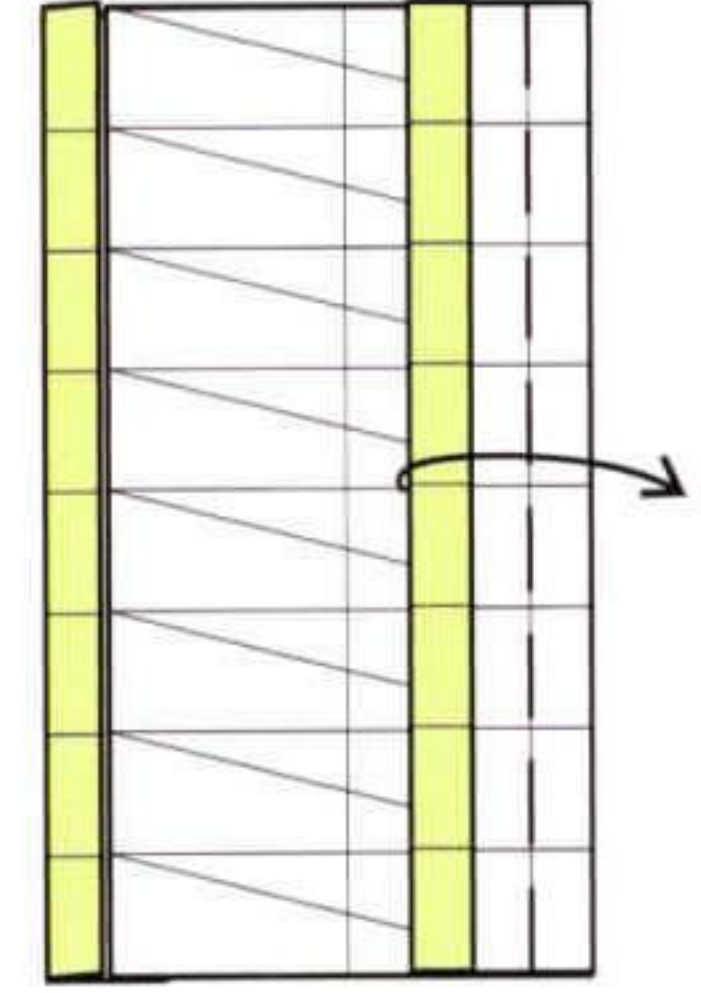

16 Fold the section back again.

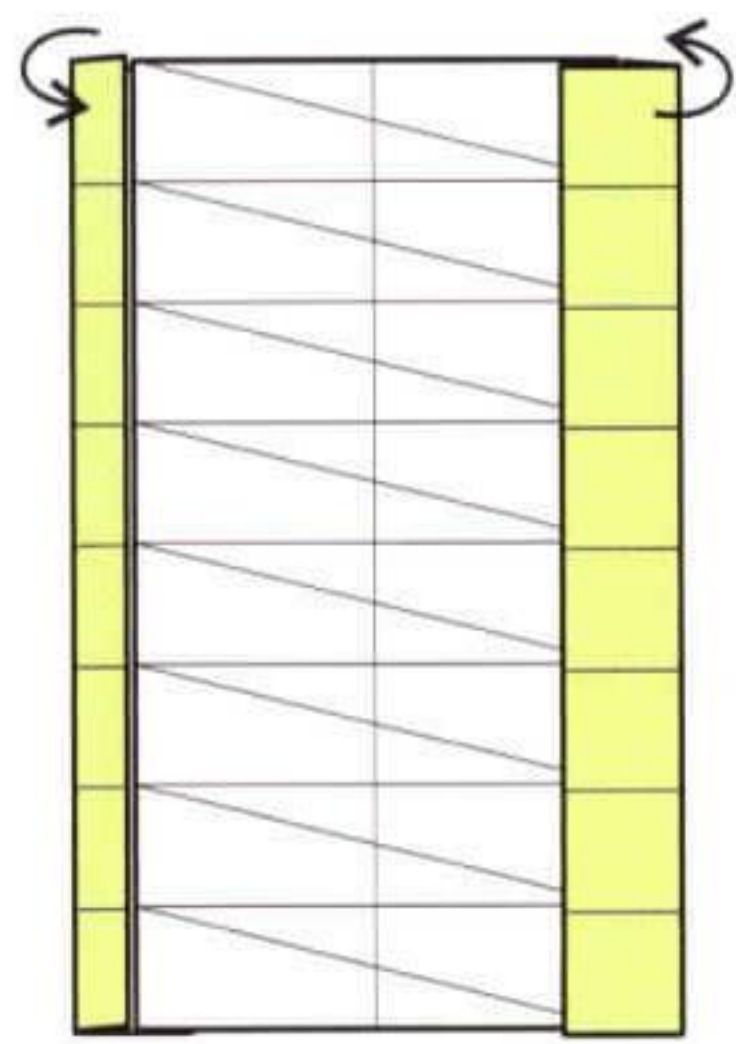

17 Fold the outer sections out to be perpendicular to the inner section.

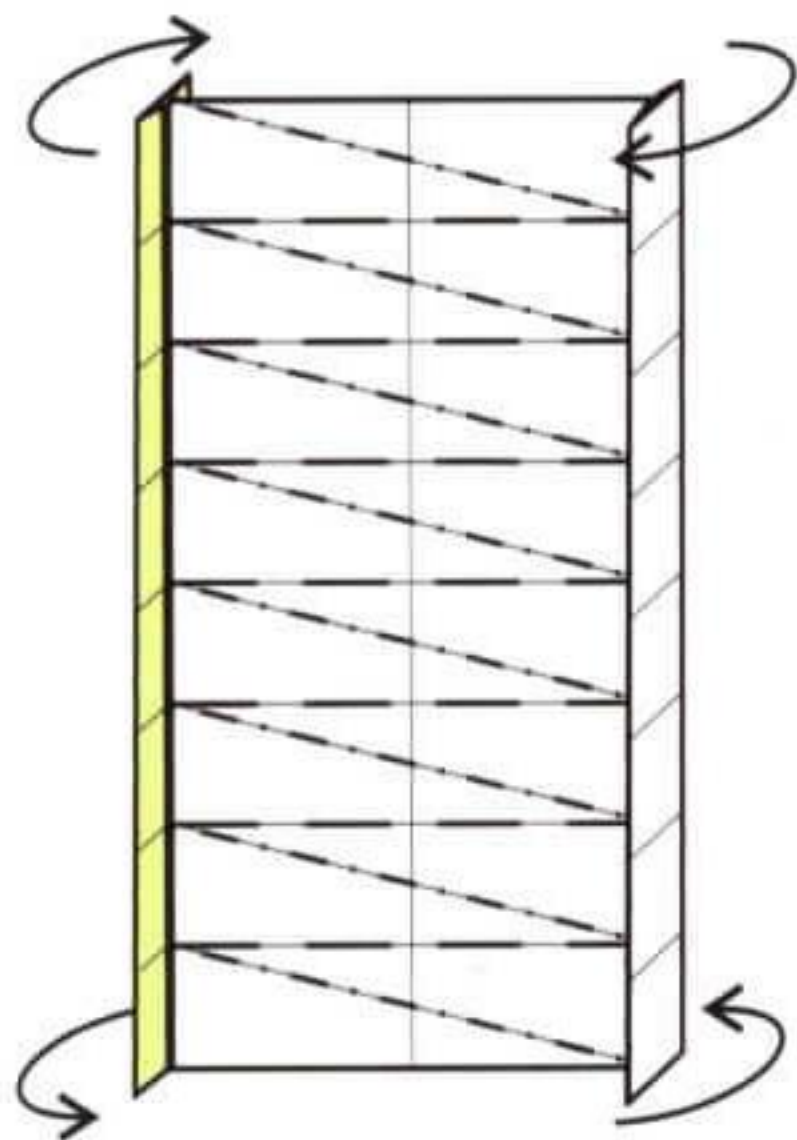

18 Re-fold the creases made in the inner section. This will cause the model to twist (see opposite).

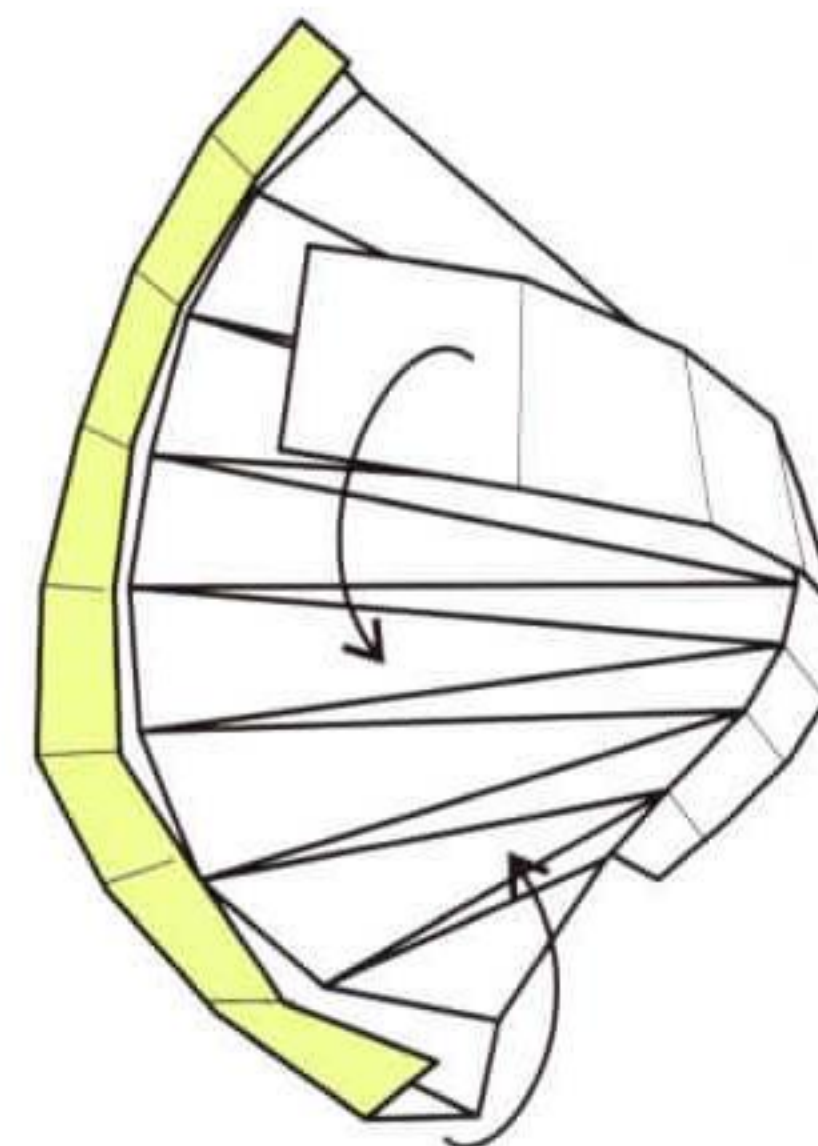

19 Complete the twist to flatten the inner section.

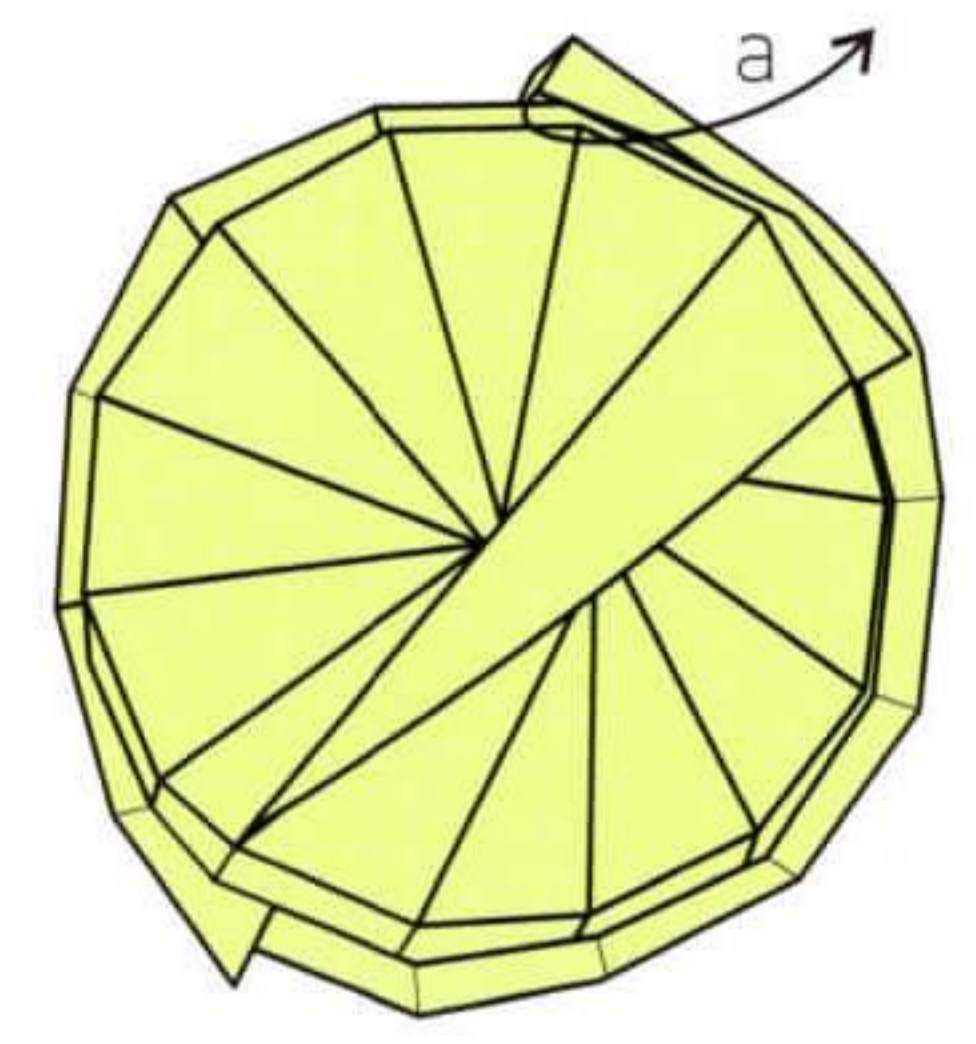

20 The two sides should fit together. Now open out the folded edge at (a) and wrap the paper around the edge of the opposite side.

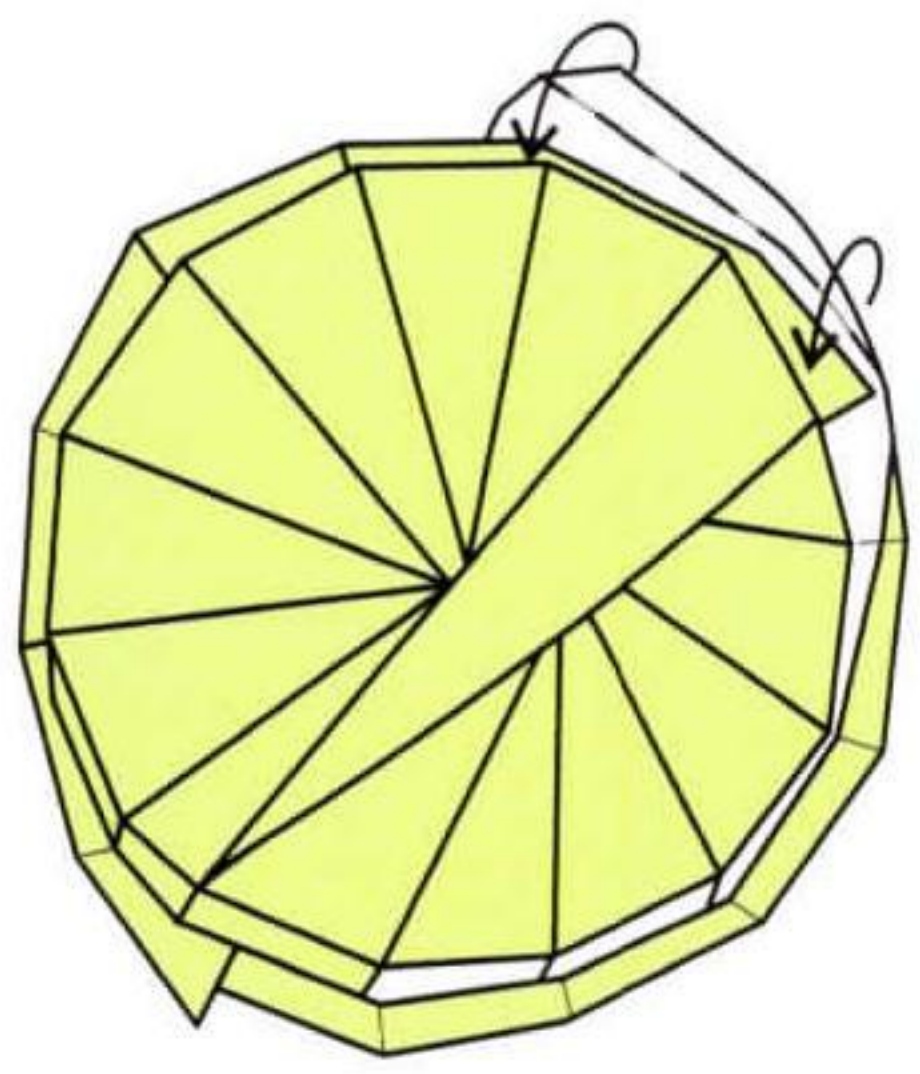

21 Fold the edge (a) from step 20 back over the inserted side of the model.

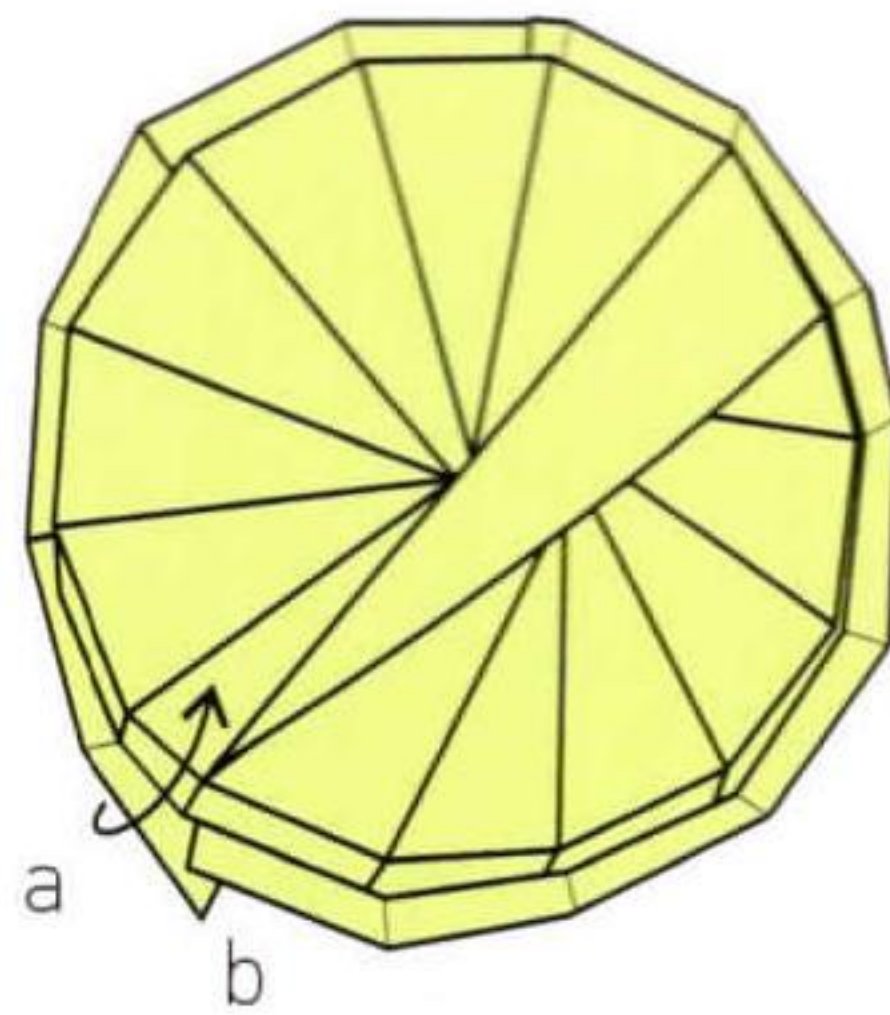

22 Open the paper (a) in the other end and wrap it around the edges

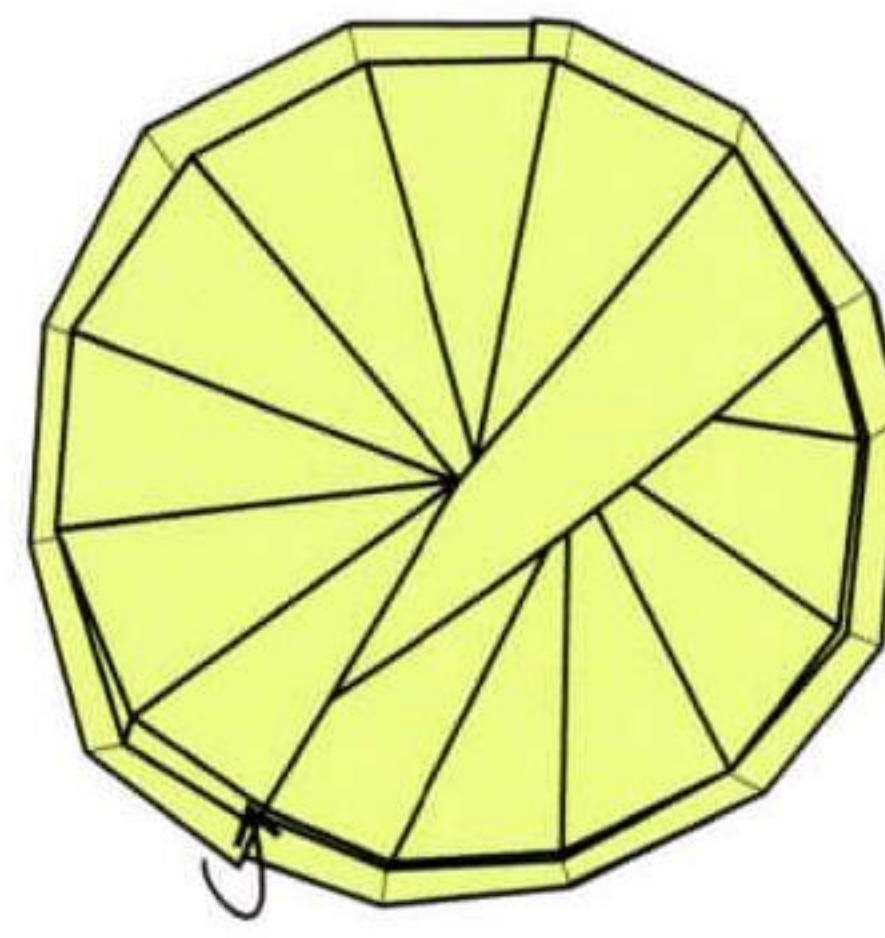

23 Fold the edge back over.

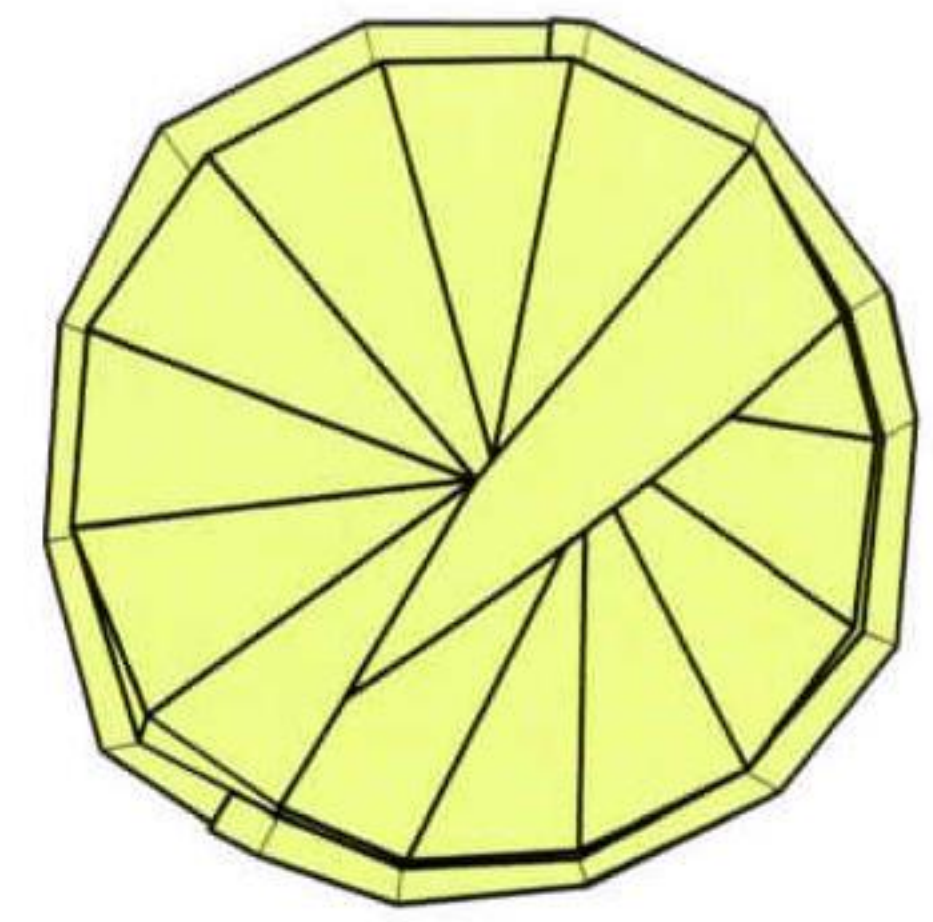

24 Complete.

FINAL ASSEMBLY OF THE DNA WHEEL



18 Refold the diagonal folds. This will cause the paper to start twisting.

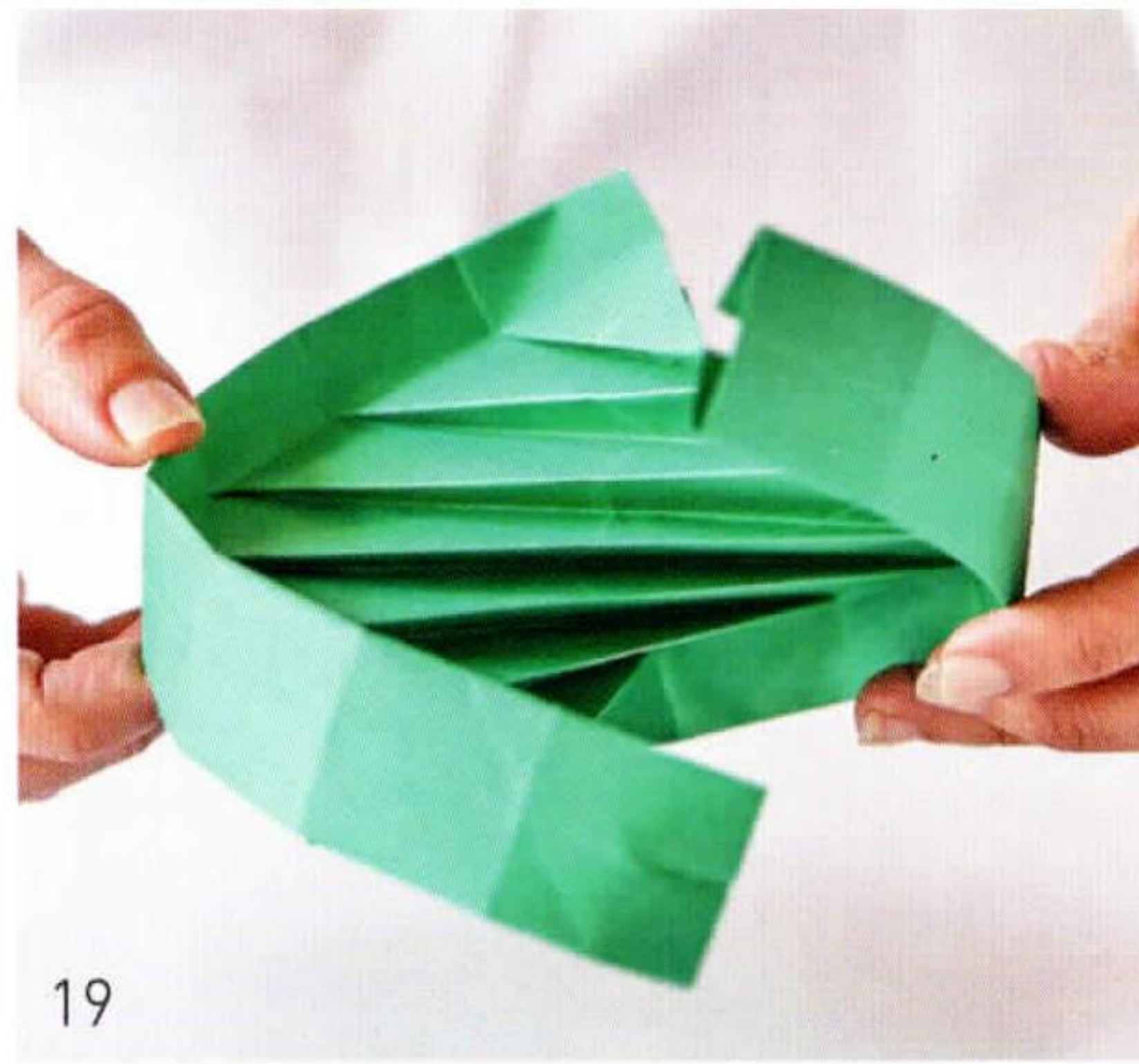

19 Keep twisting the middle section until the ends match up.

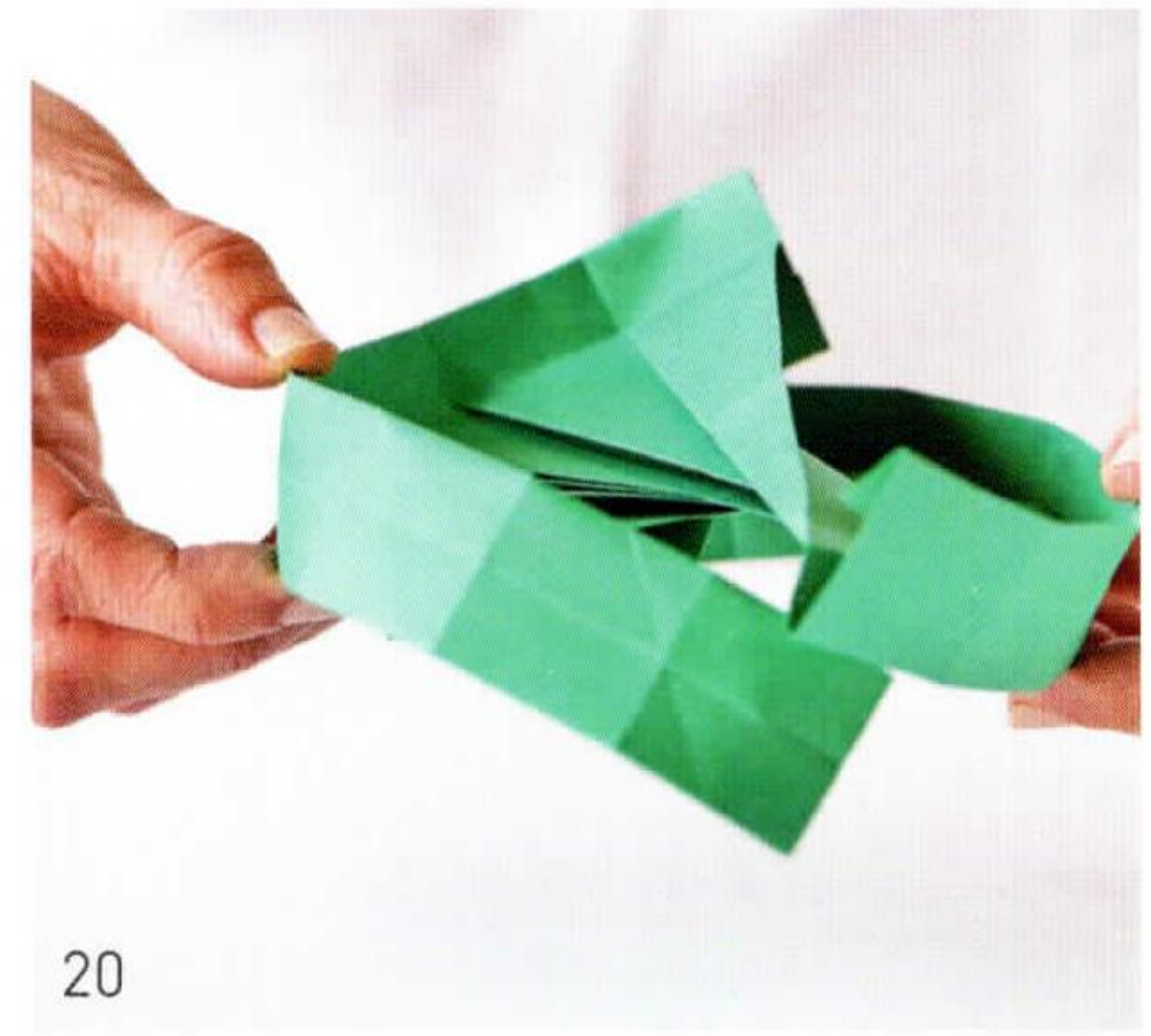

20 Unfold the paper in one end and insert the other end.

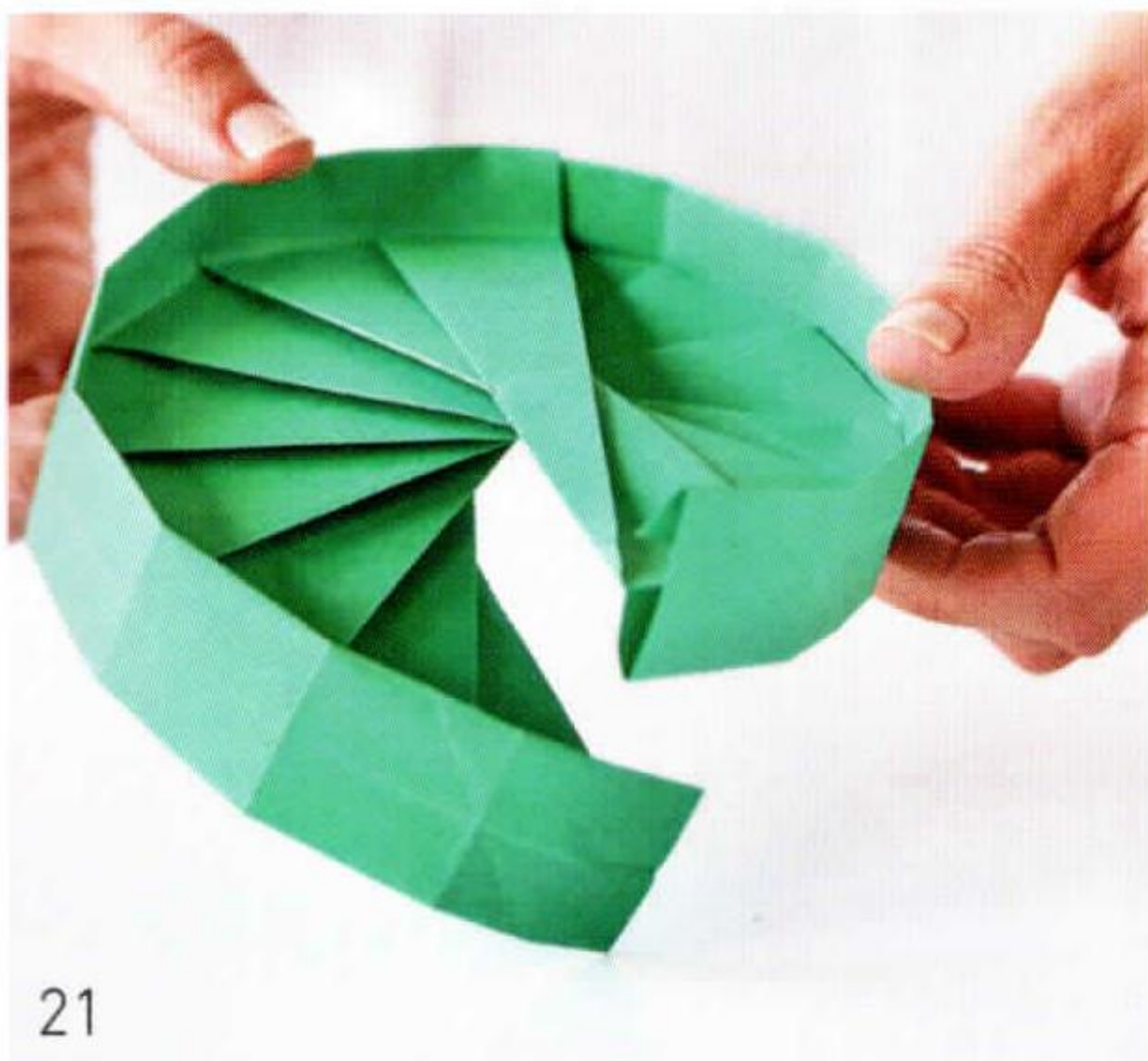

21 Flatten the middle section and align the opposite ends.

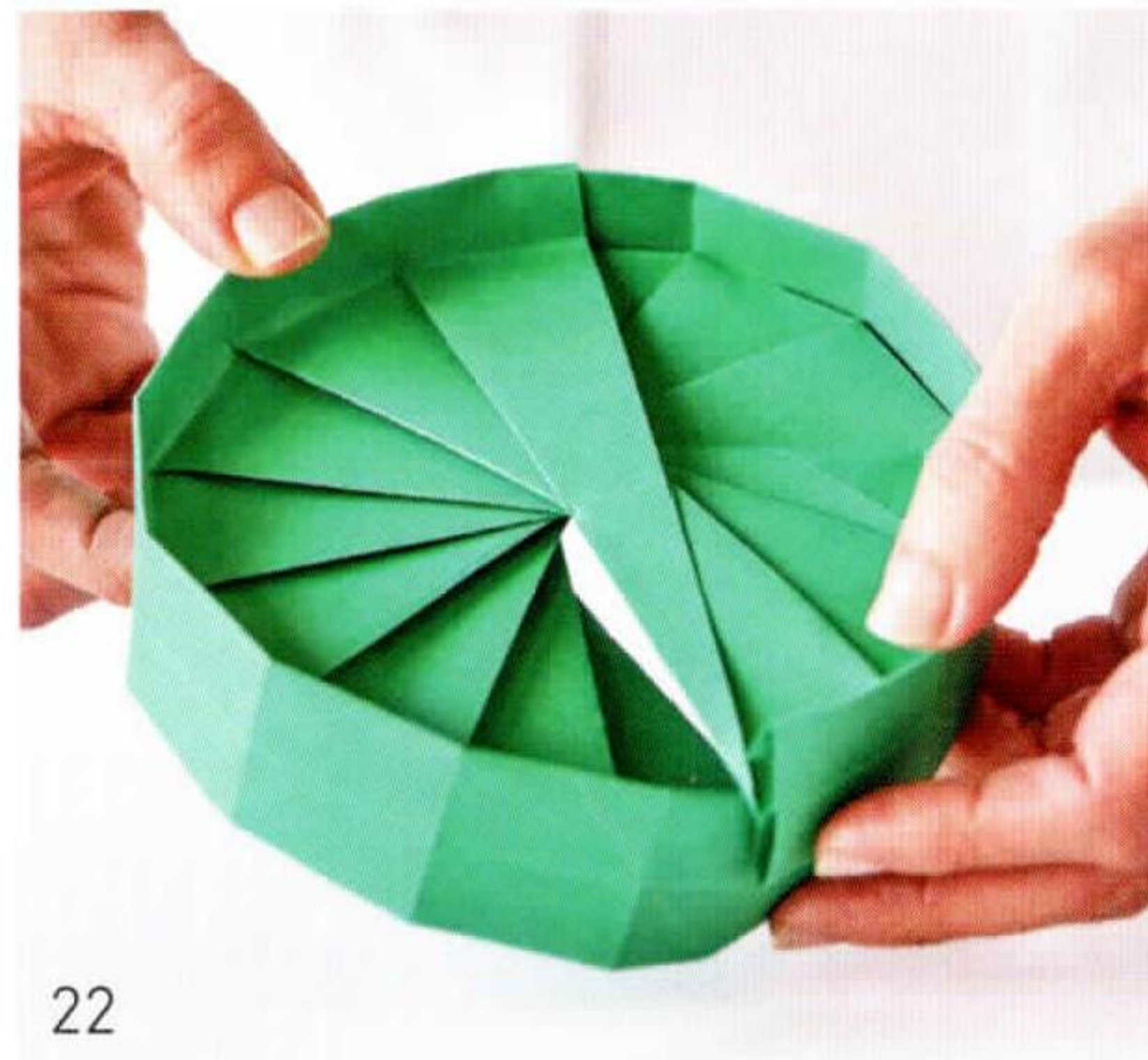

22 Open the paper in one of the ends and insert the other end.



23 Firm up the creases around the edges to complete the model.

Flexagon One

**

The flexagon is a model that can be rotated in on itself. It is made from six triangular tetrahedra that can be twisted to show four separate hexagonal faces.

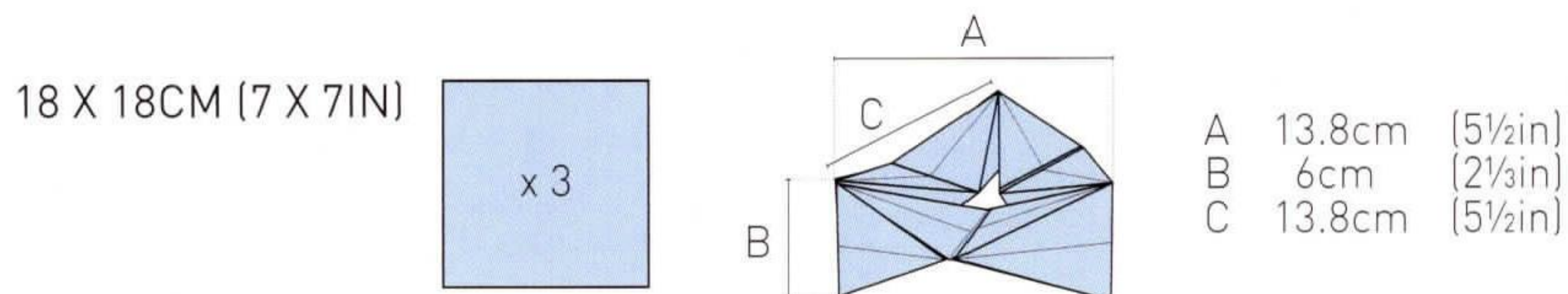

THE MODEL IS MADE FROM THREE SQUARES OF EQUAL SIZE. FOR EACH OF THE THREE UNITS START WITH A SQUARE, COLOURED SIDE UP.

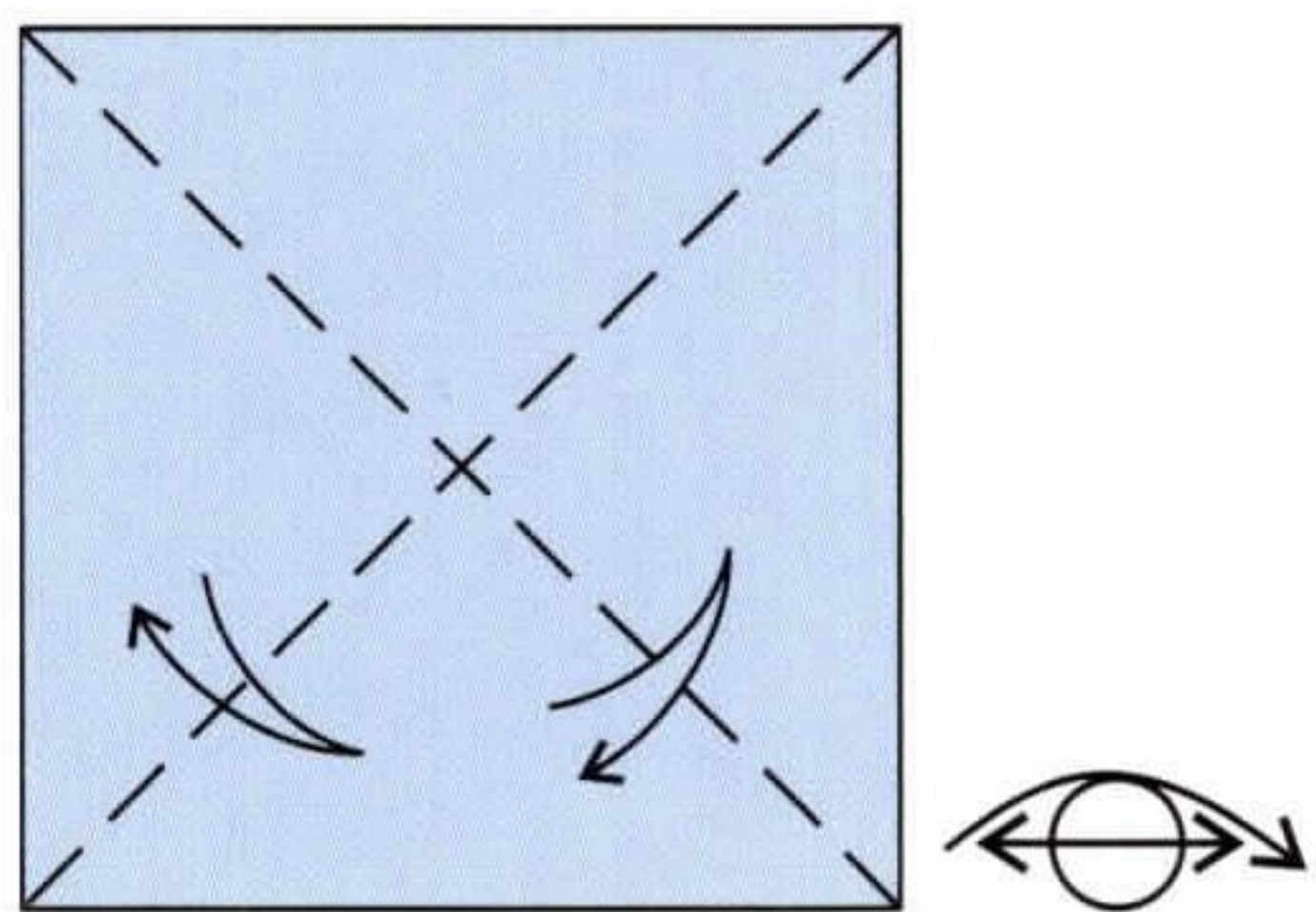

- 1 Fold the square in half diagonally. Then turn the paper over left to right.

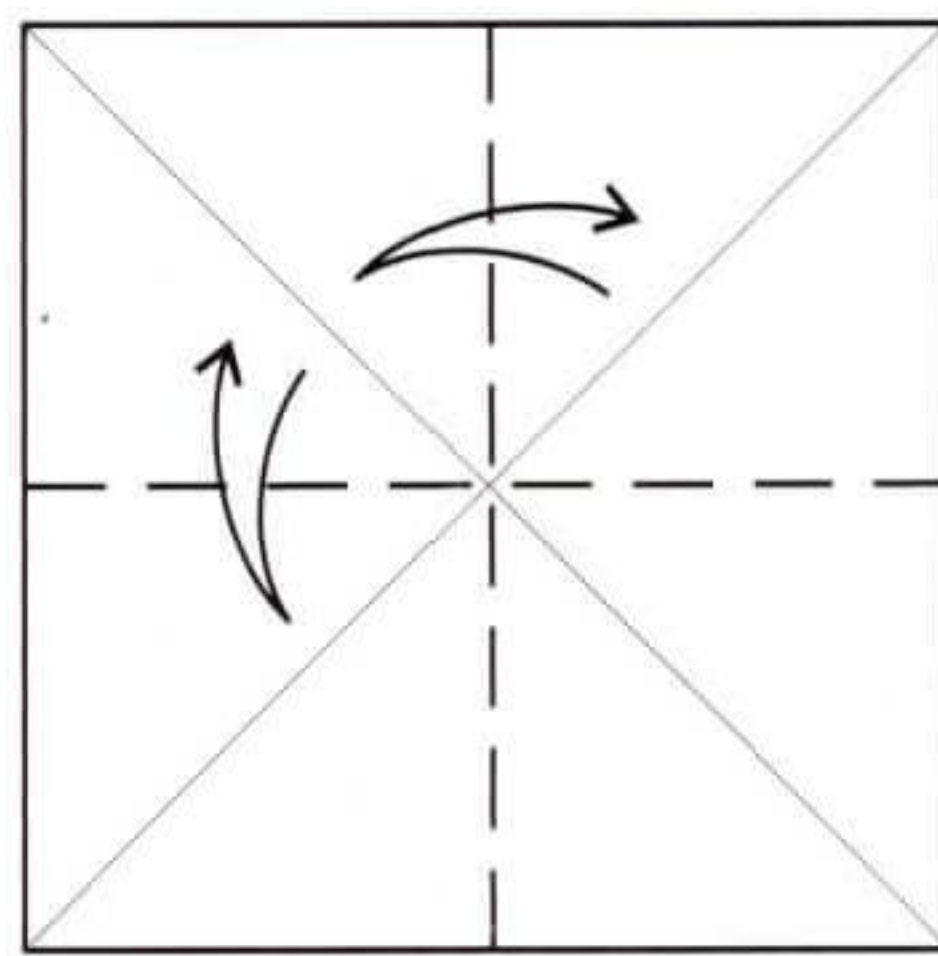

- 2 Fold and unfold the paper lengthwise along the middle.

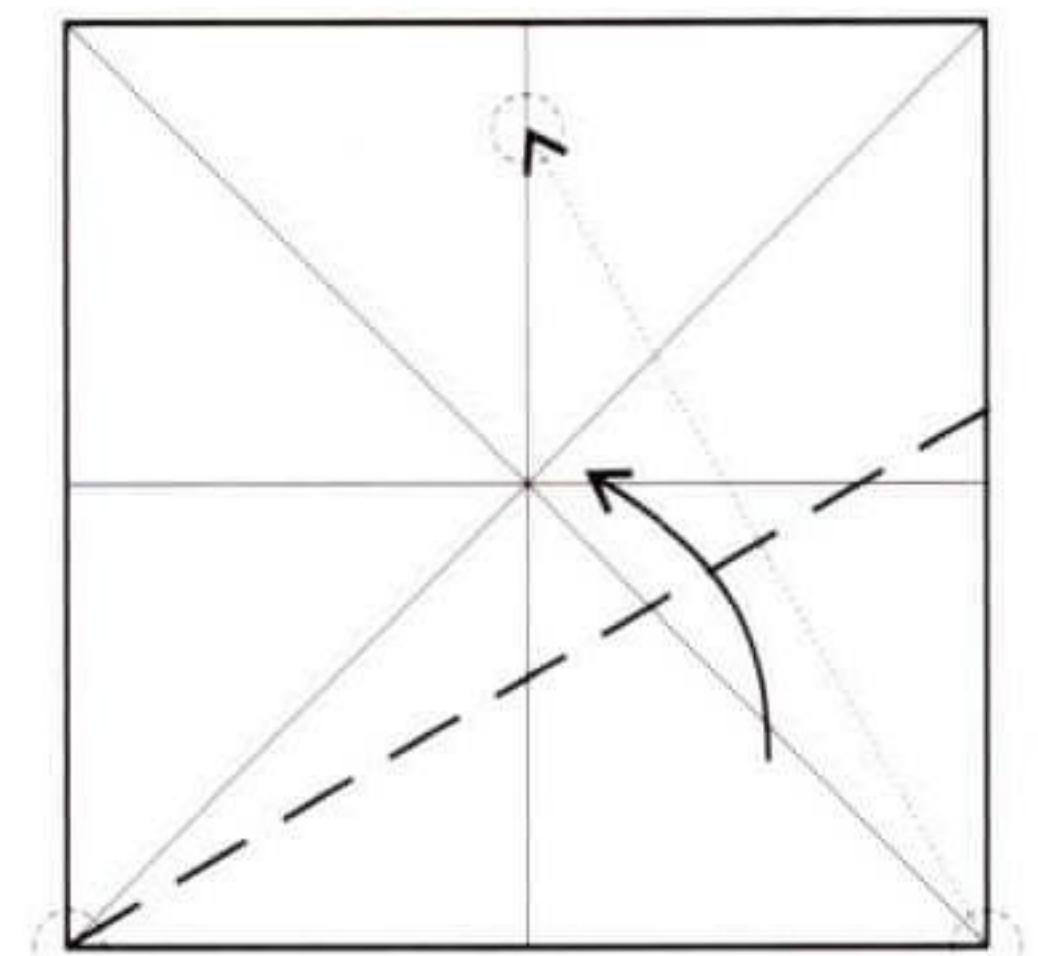

- 3 Fold the lower right corner up to touch the middle crease.

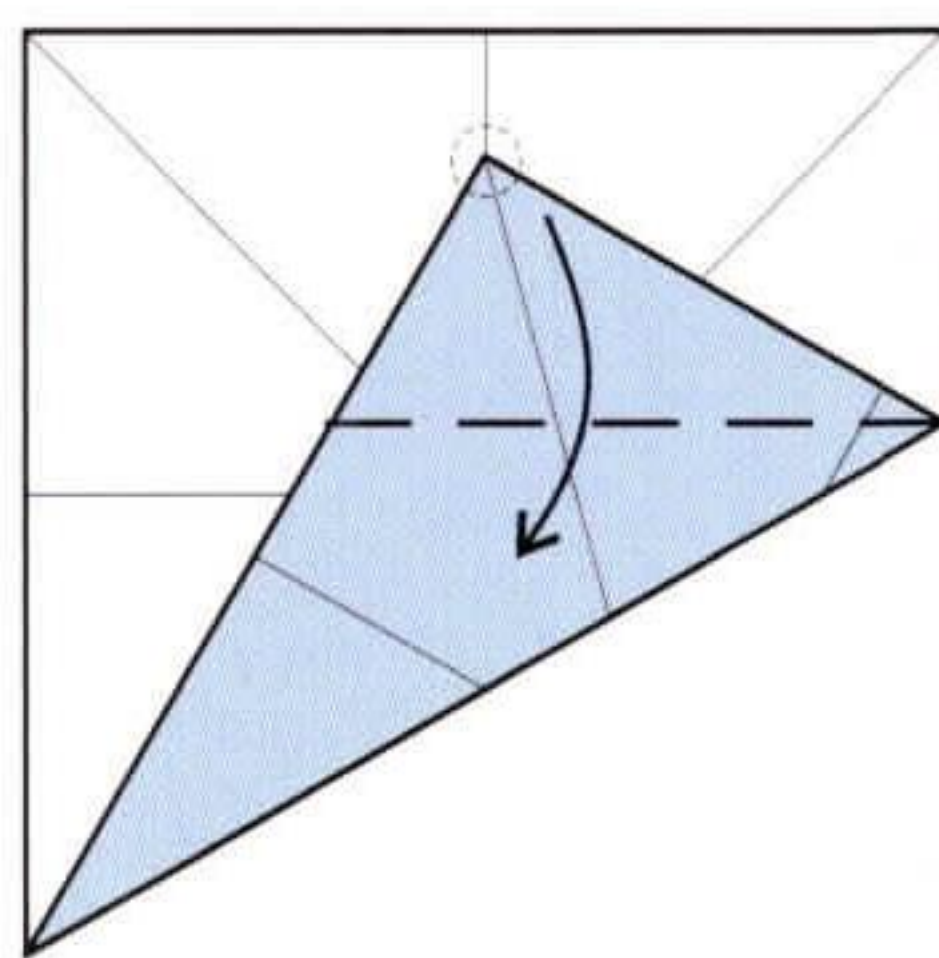

- 4 Fold the corner back to the lower folded edge.

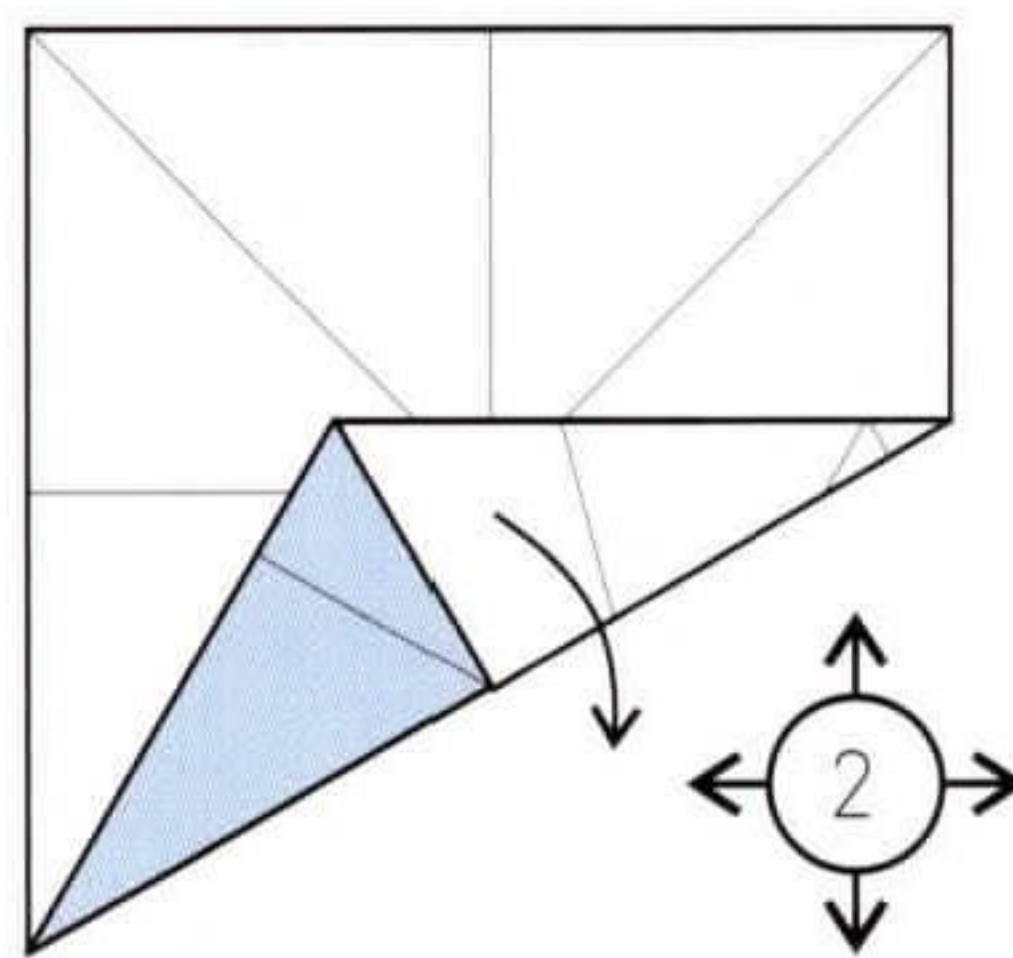

- 5 Unfold the folded corner.

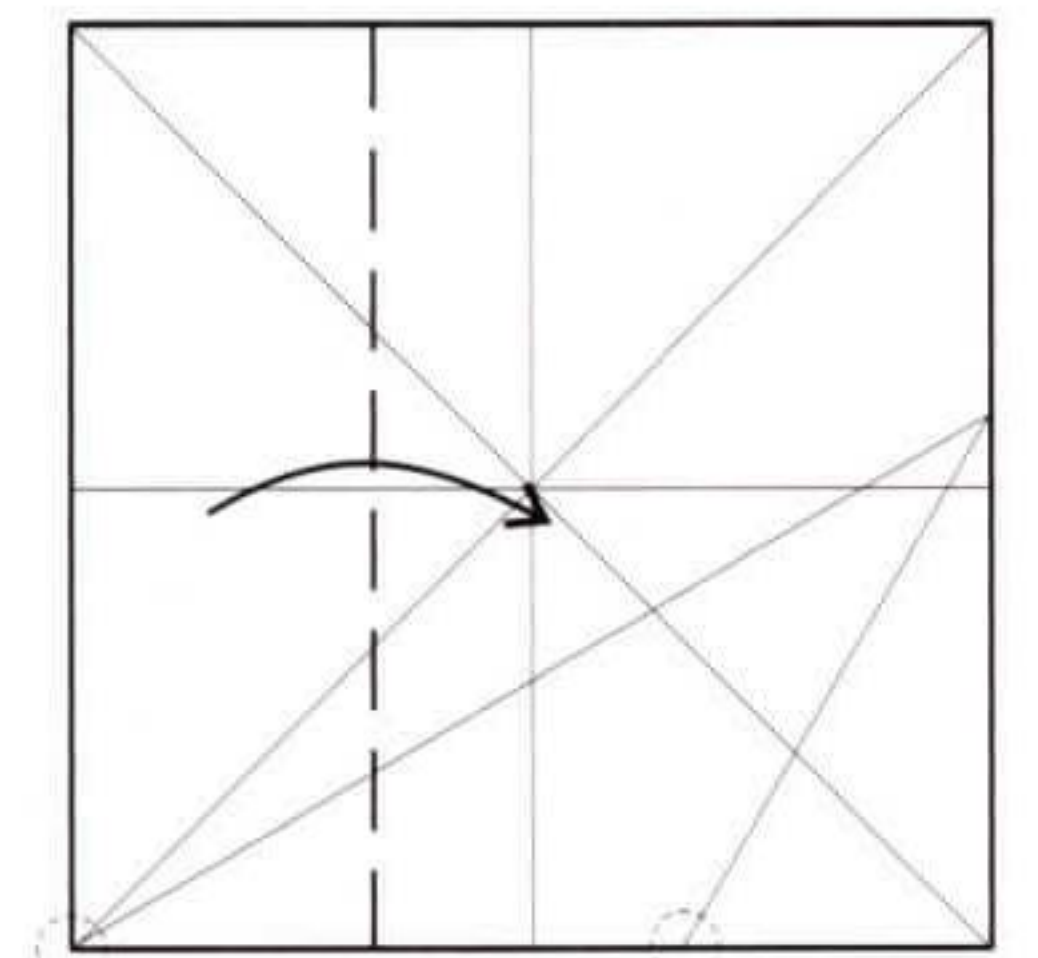

- 6 Fold the left side over. The edge should touch the crease made previously.

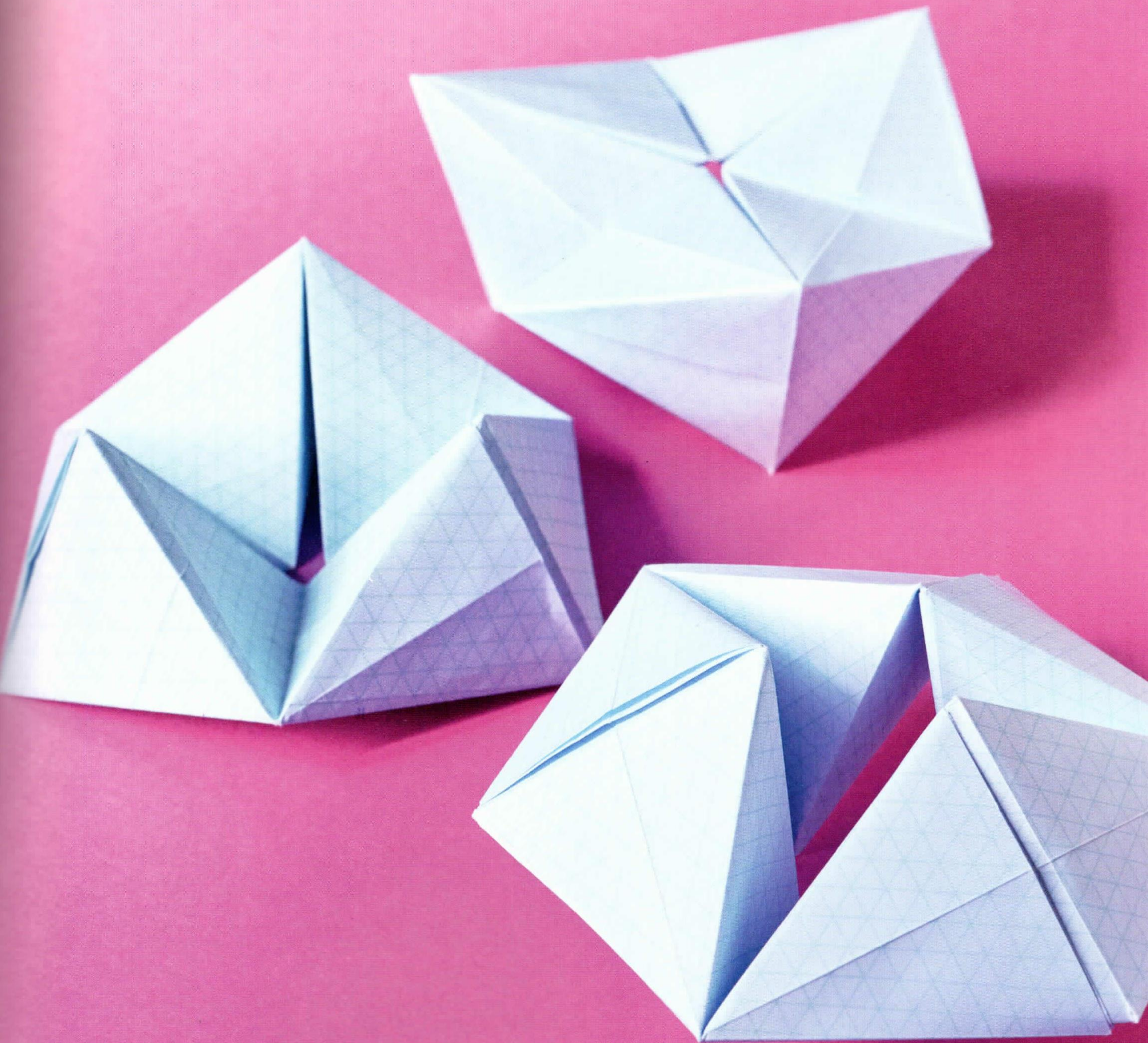

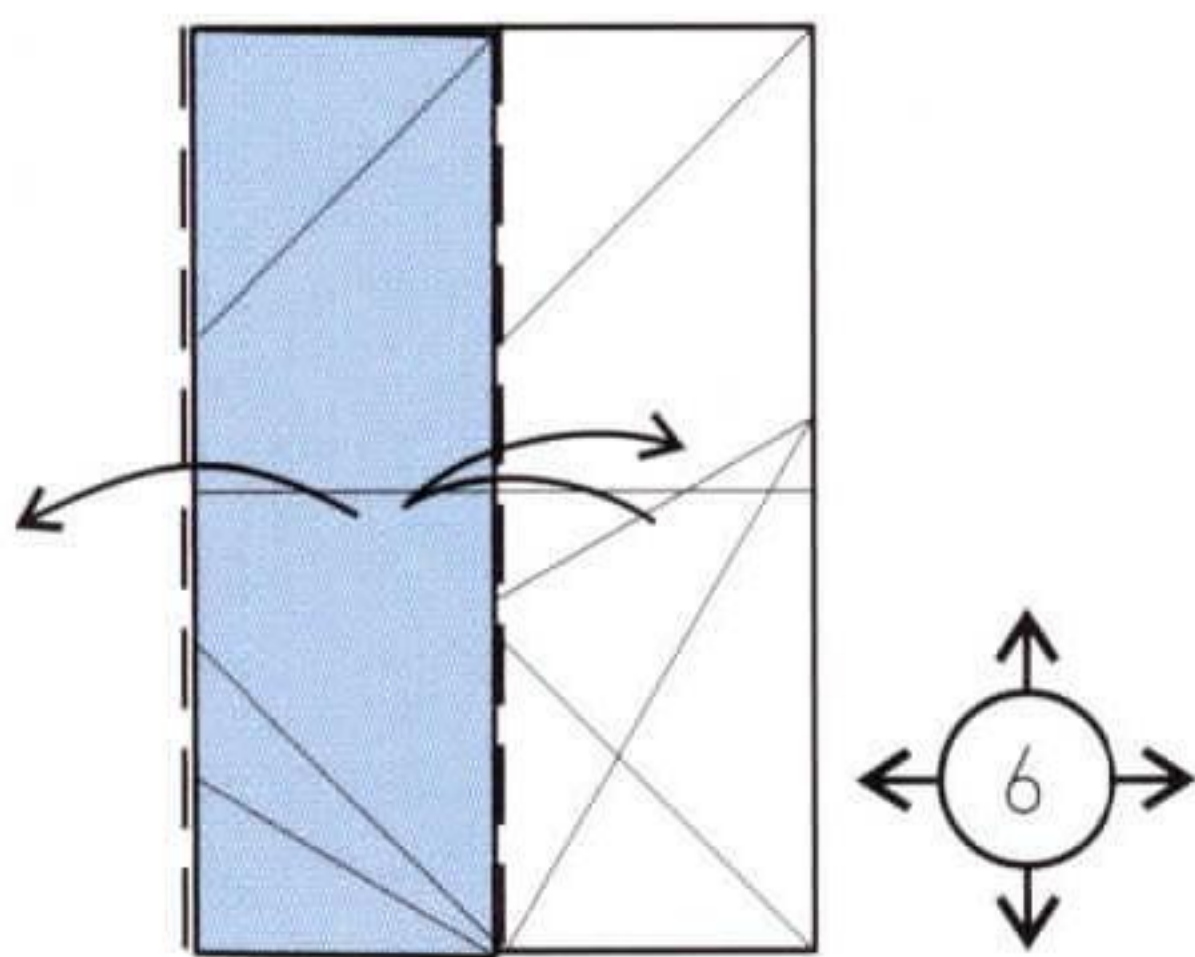

7 Fold the right side over. Then unfold both sides.

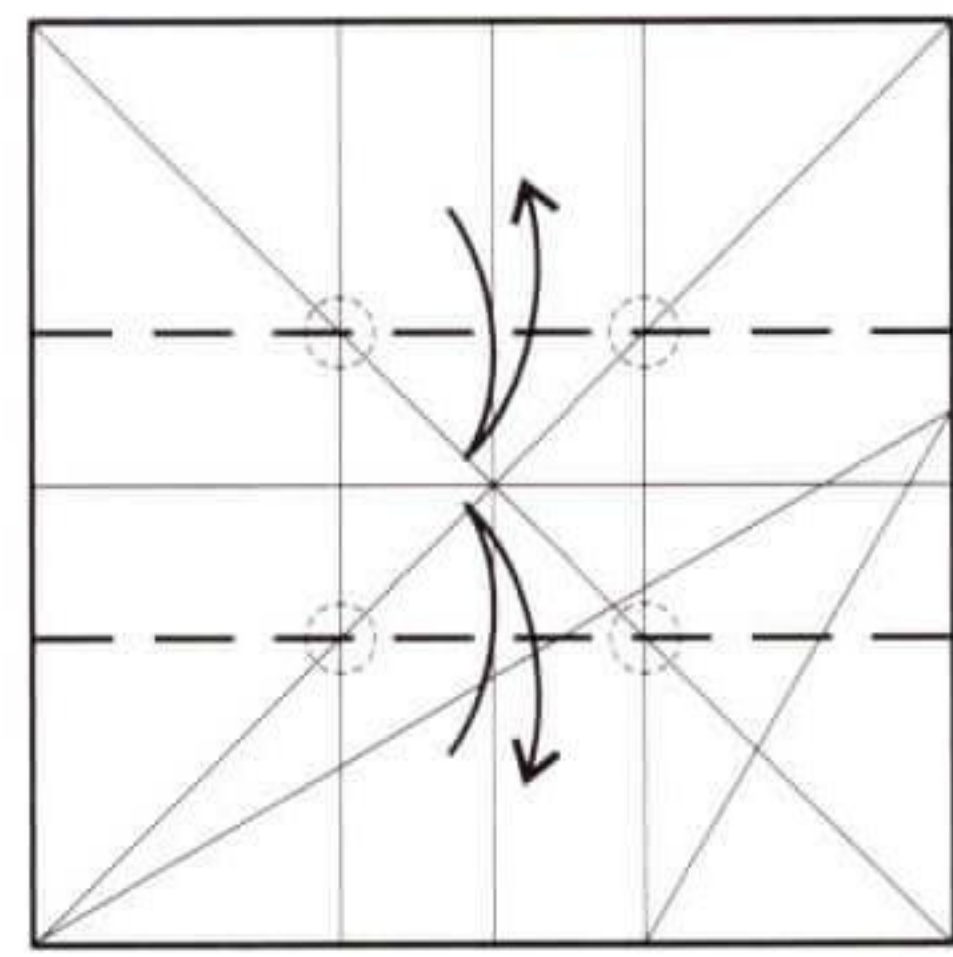

8 Fold in outer edges to cross the intersection of the creases to form thirds. Then unfold.

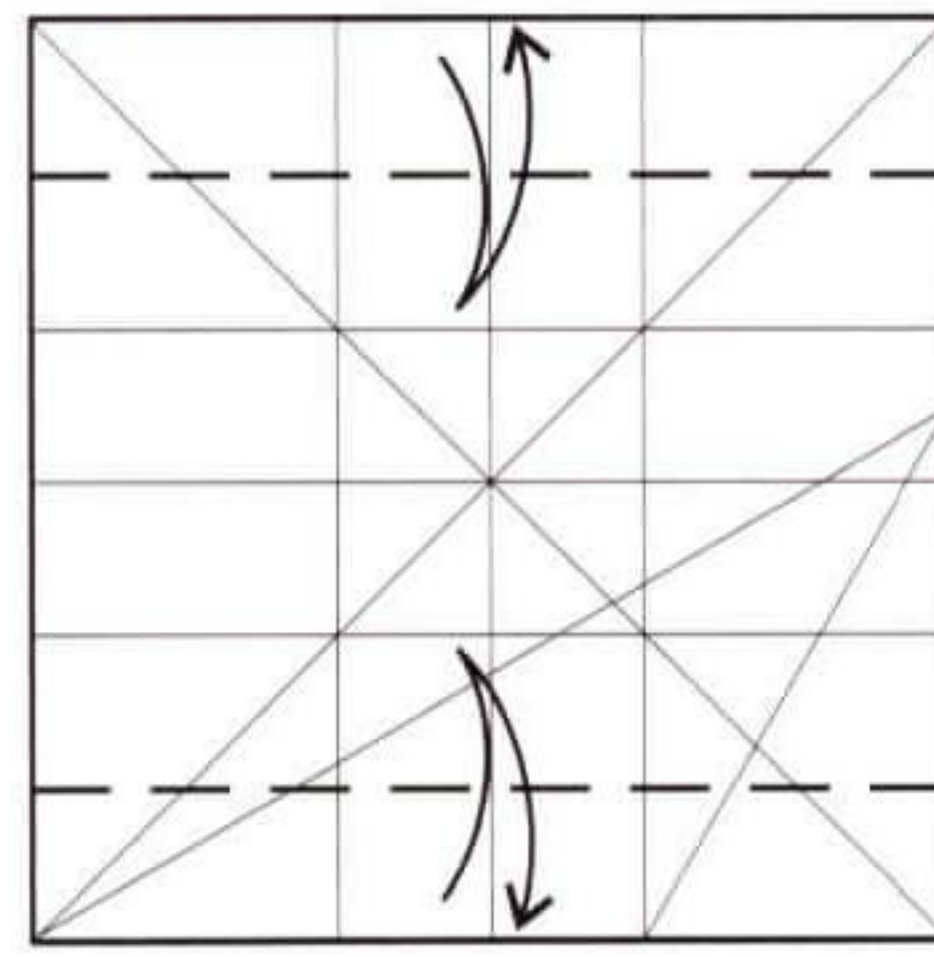

9 Fold the edges in, so they touch the adjacent creases. Then unfold.

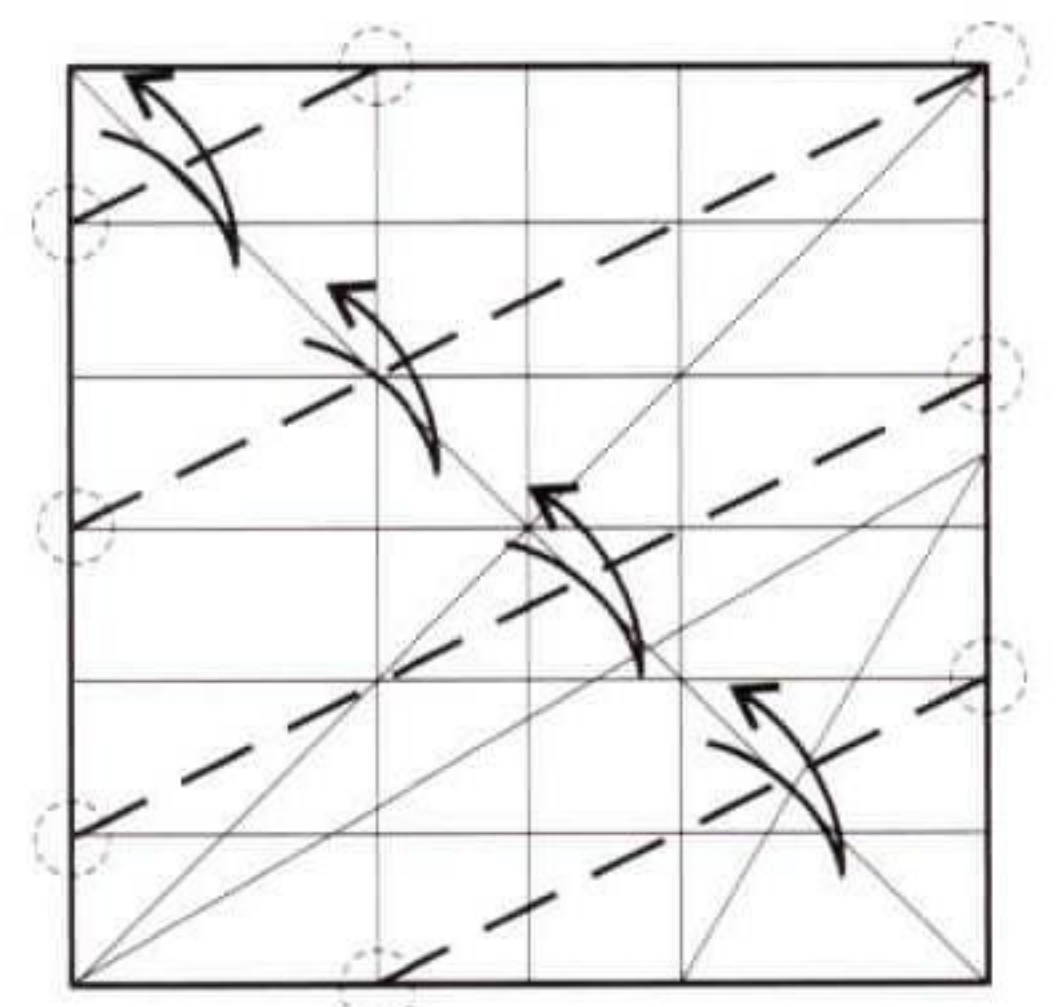

10 Make diagonal folds between the reference points indicated.

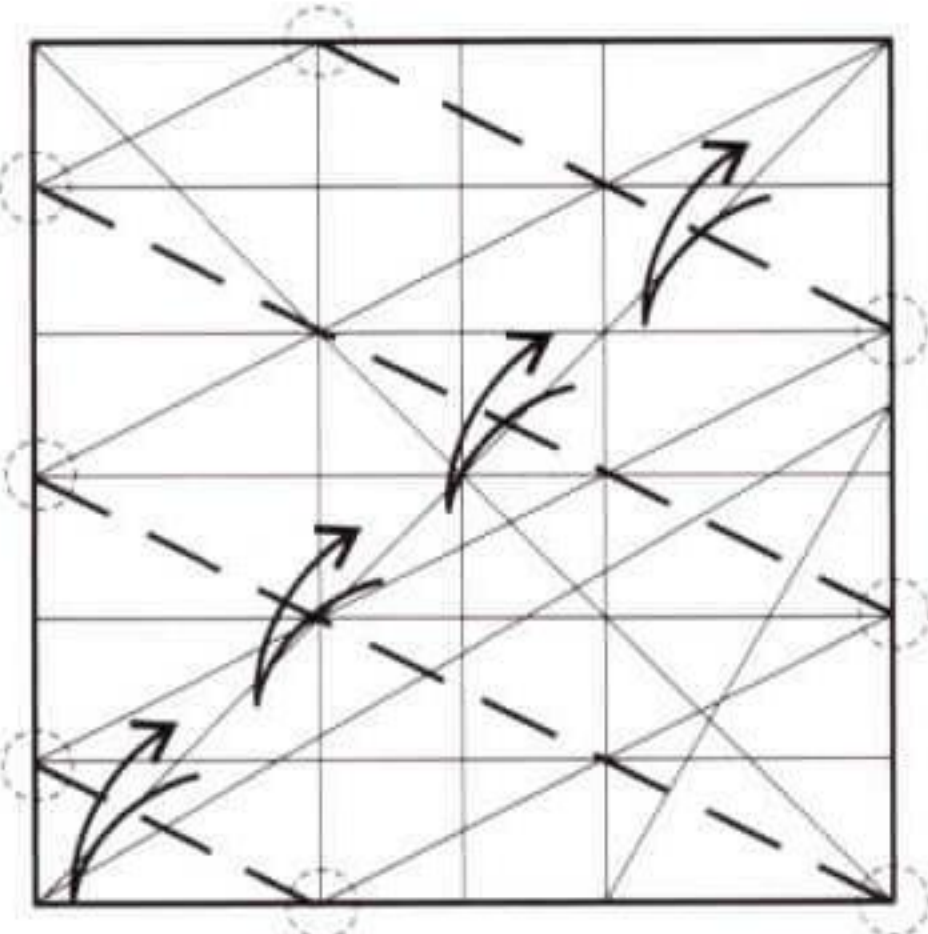

11 Make diagonal folds going in the opposite direction.

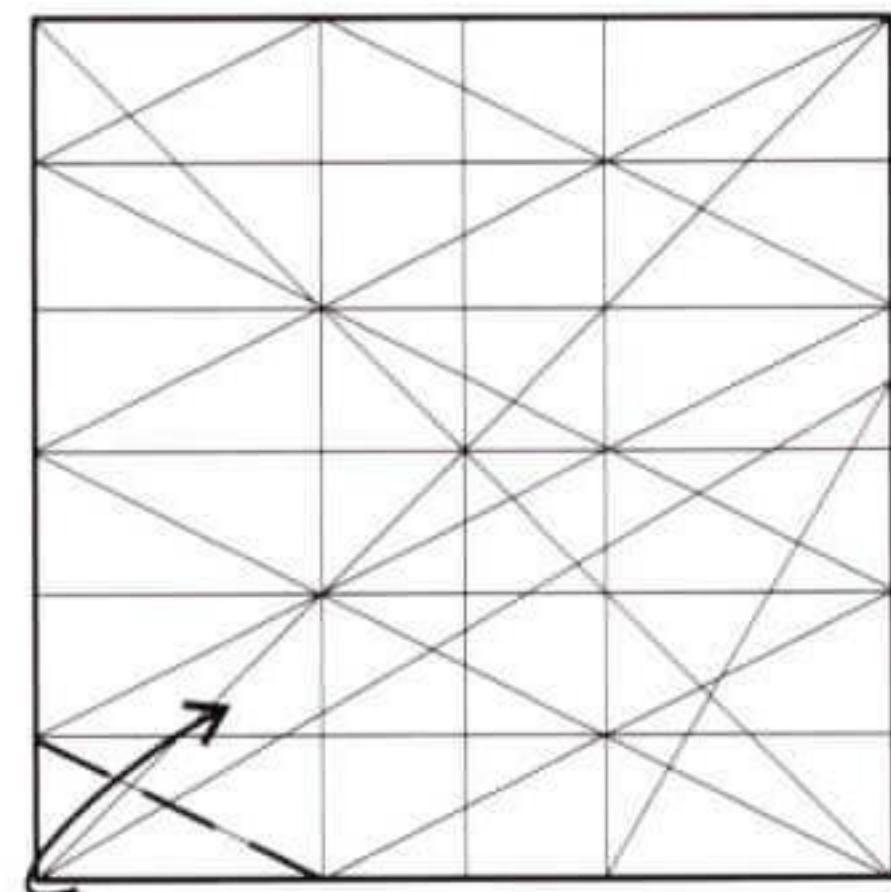

12 Fold over the lower left corner.

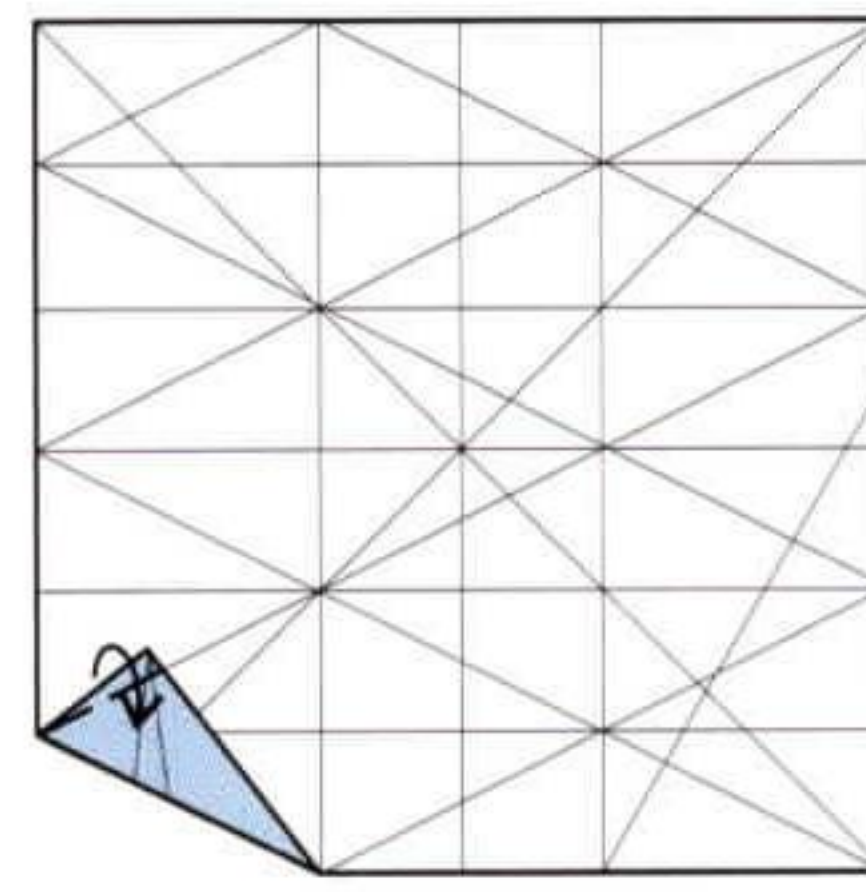

13 Fold over the edge of the folded corner.

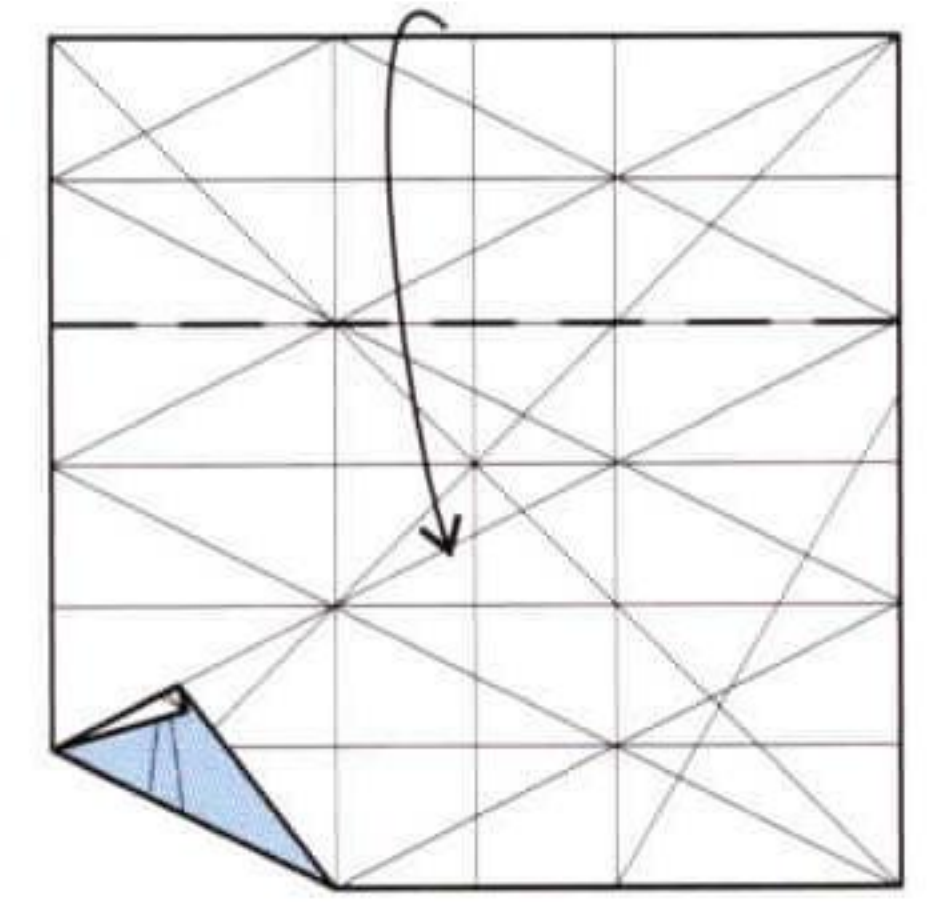

14 Fold upper section down along the crease made previously.

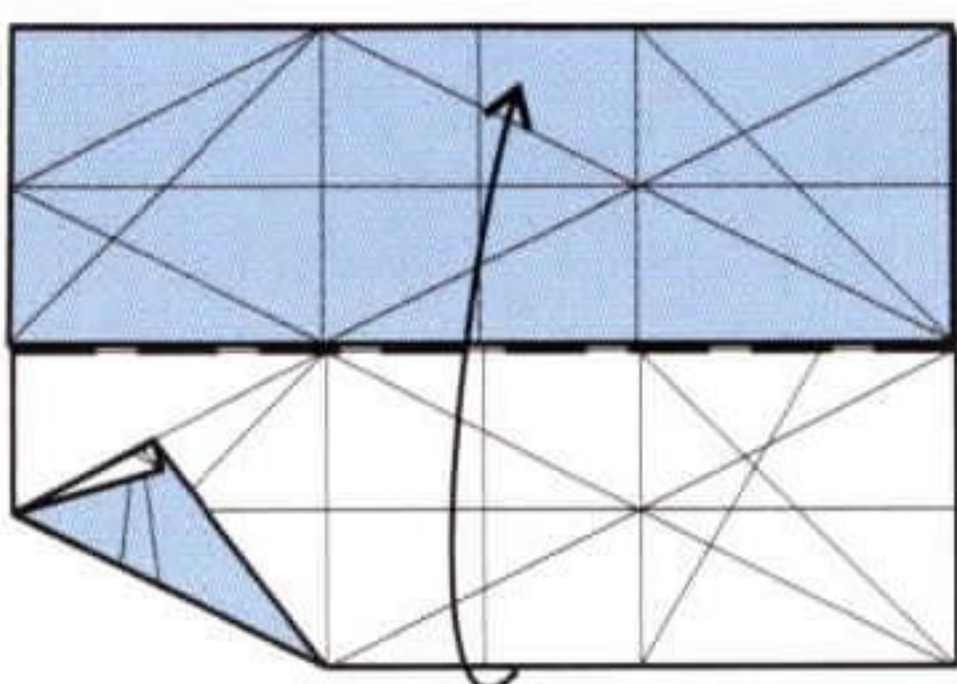

15 Fold the lower third of the square up.

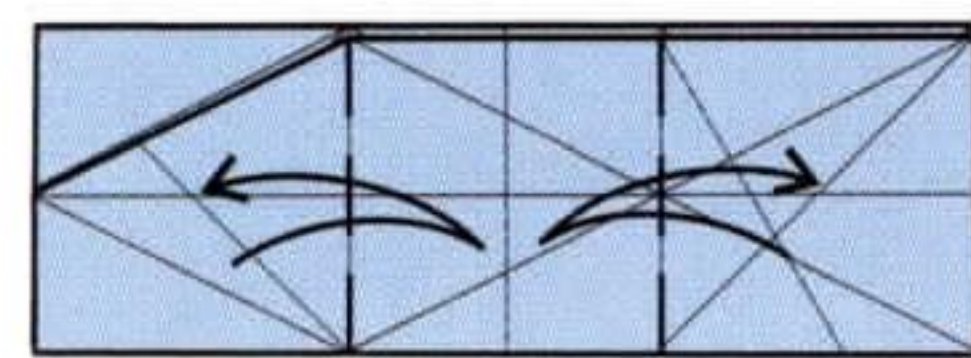

16 Fold and unfold the sides along the creases made previously.

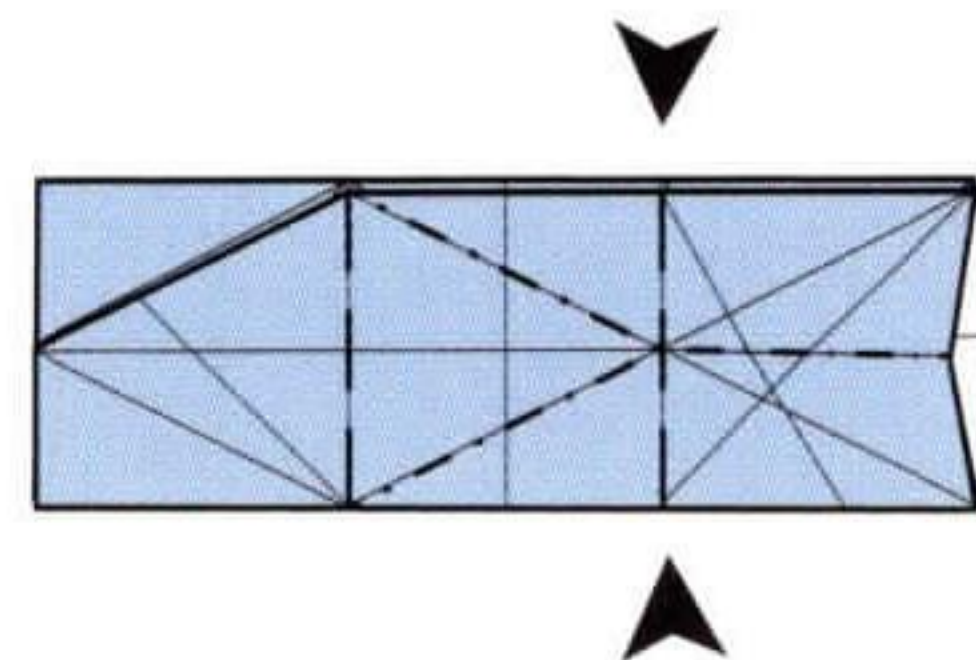

17 Squash the model, reversing the creases and making a 3D shape.

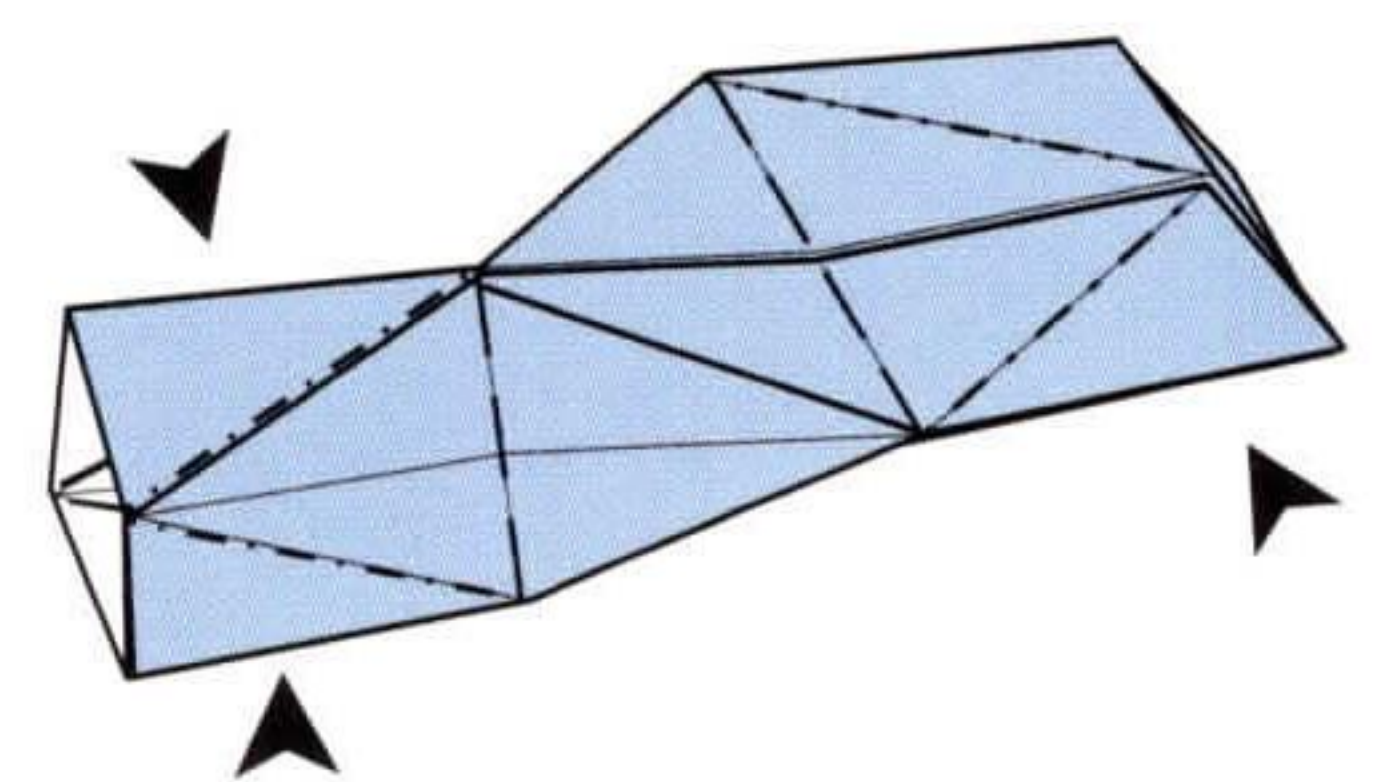

18 Squeeze the outer ends together to form more 3D tetrahedron shapes.

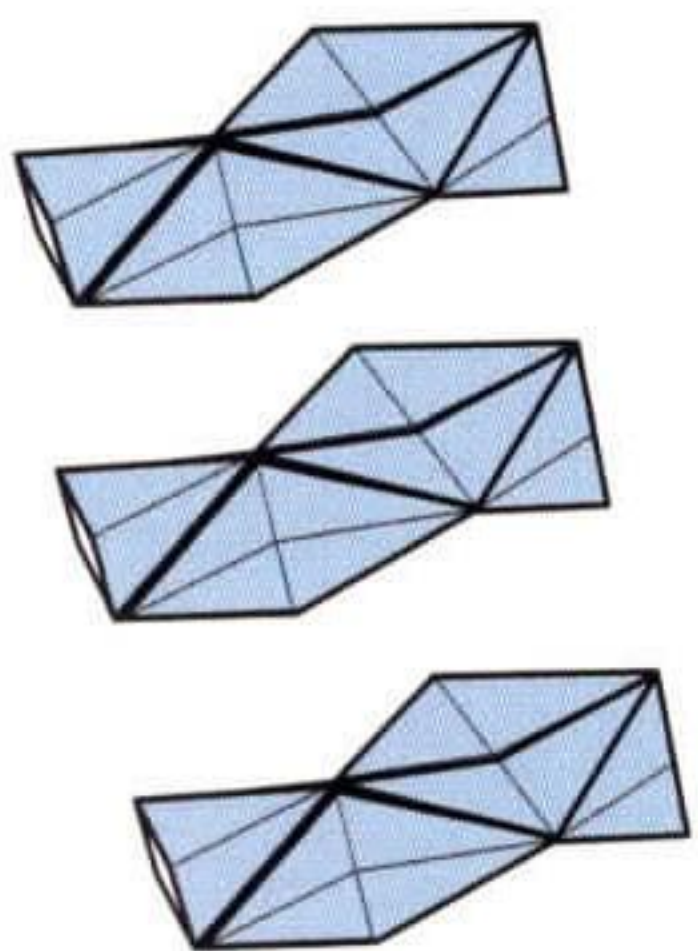

19 Make two more identical component parts (steps 1 to 18).

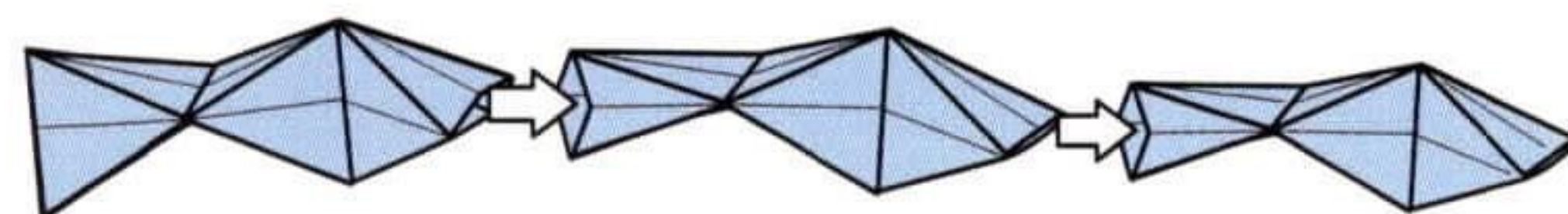

20 Insert one unit inside the other.

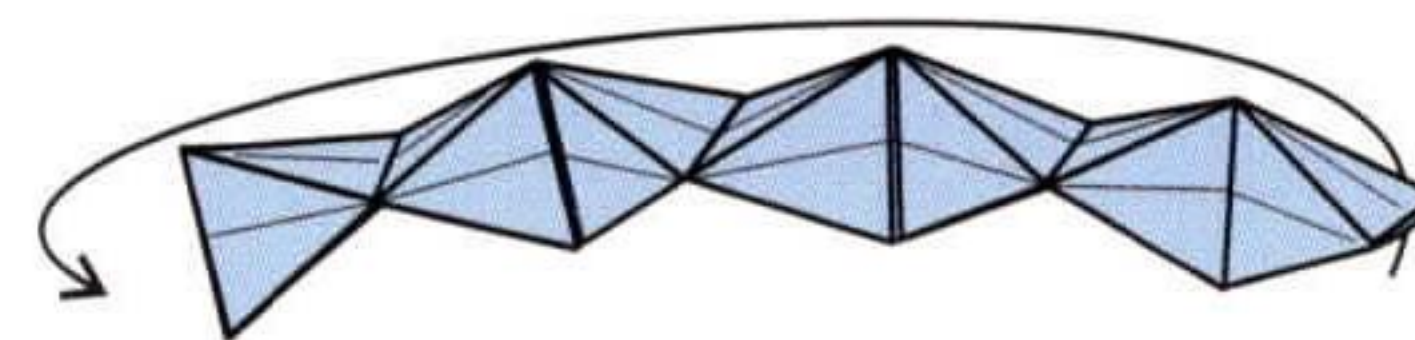

21 Insert the outer ends into each other to complete the ring.

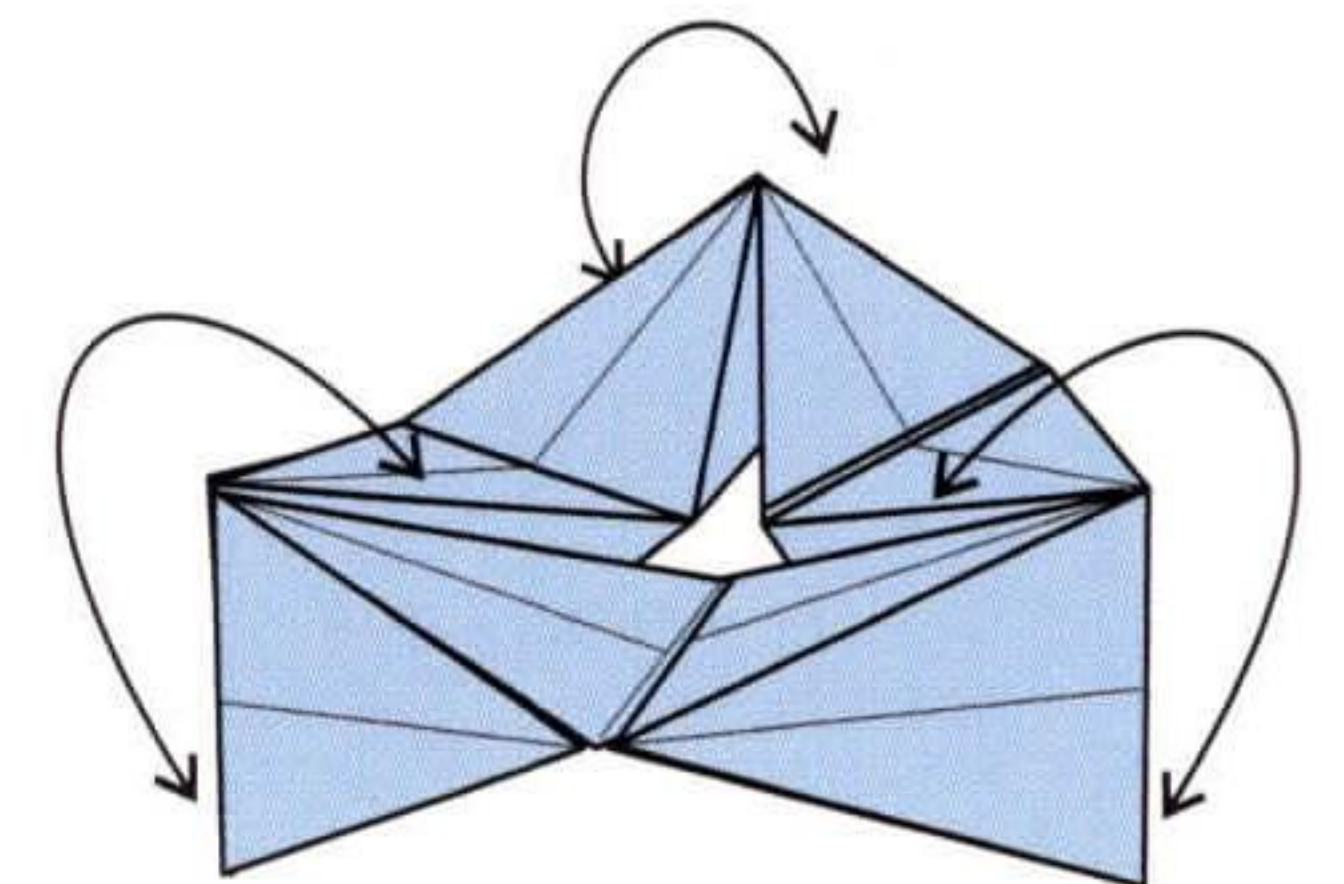

22 The model is complete. Twist the sections to rotate the model.

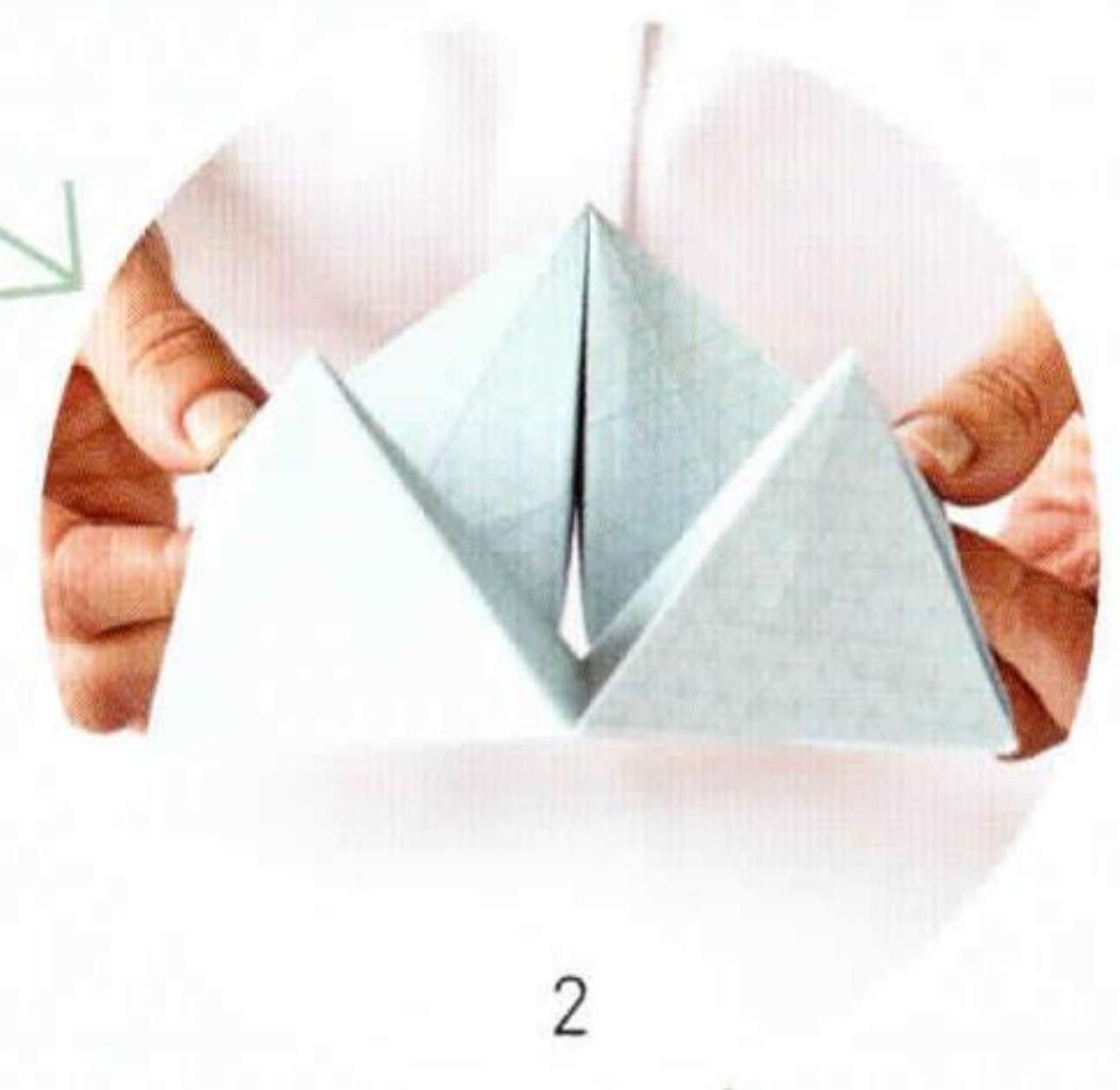
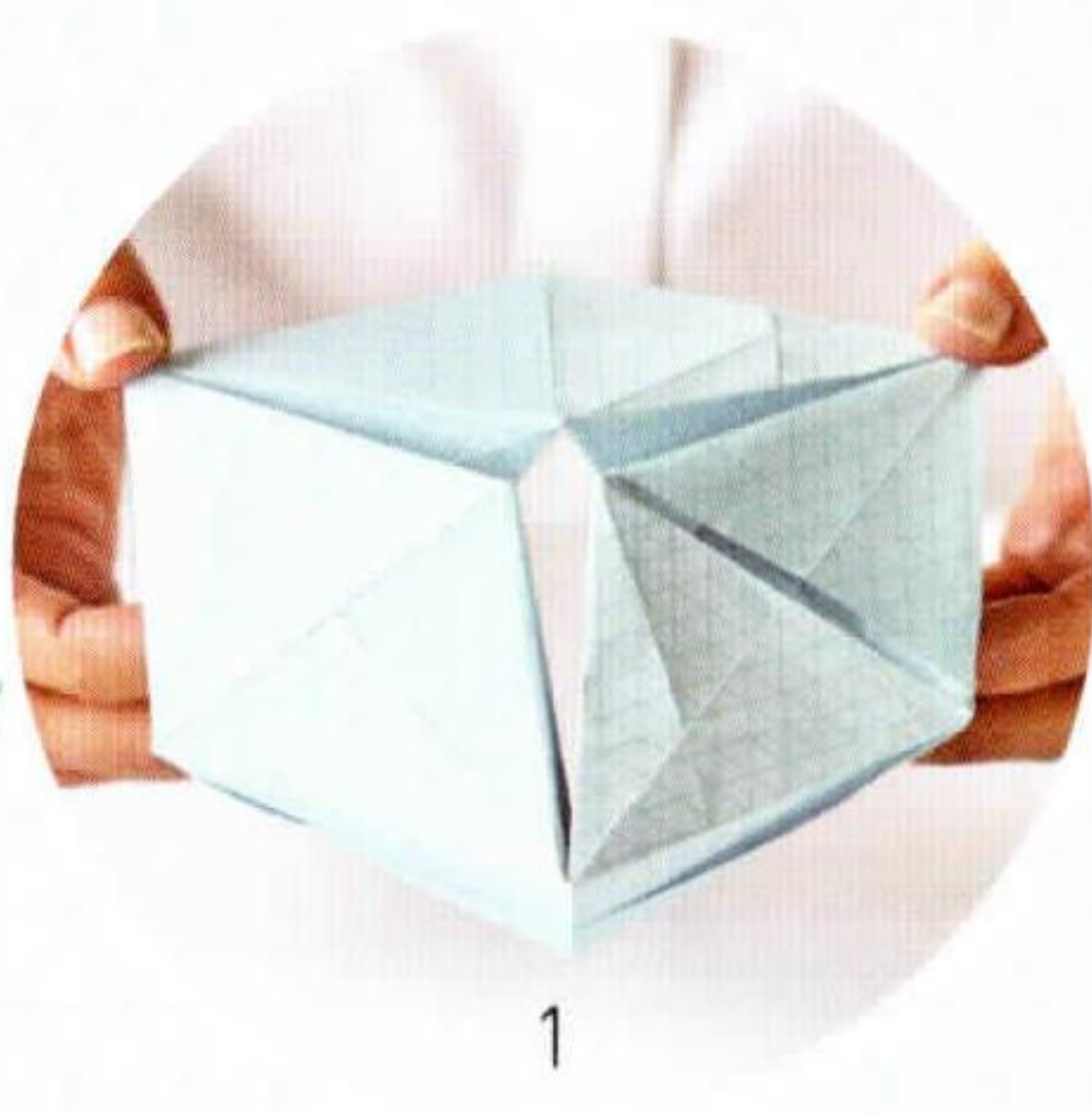
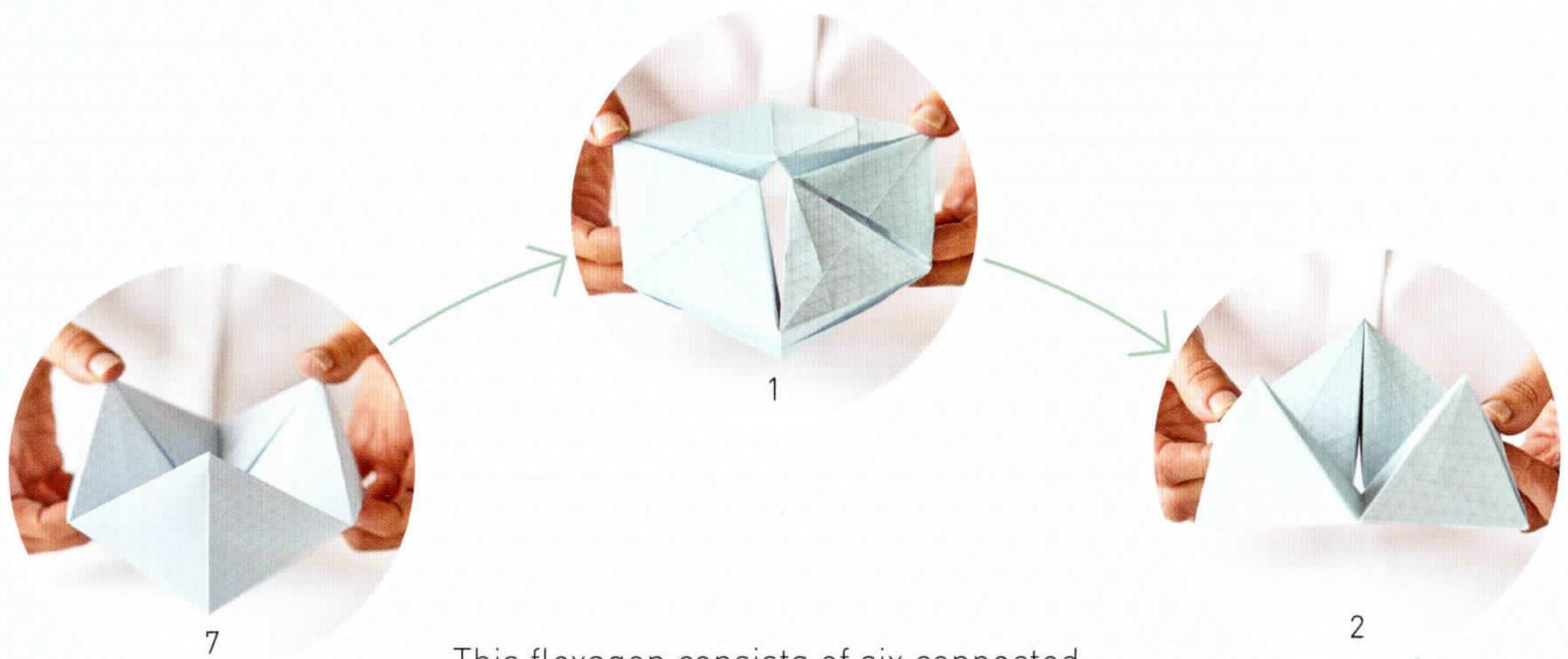

This flexagon consists of six connected triangular tetraheda. The model can be rotated by turning the sides into themselves. This process will bring the triangular faces of the tetraheda together, to eventually form four distinct hexagons.

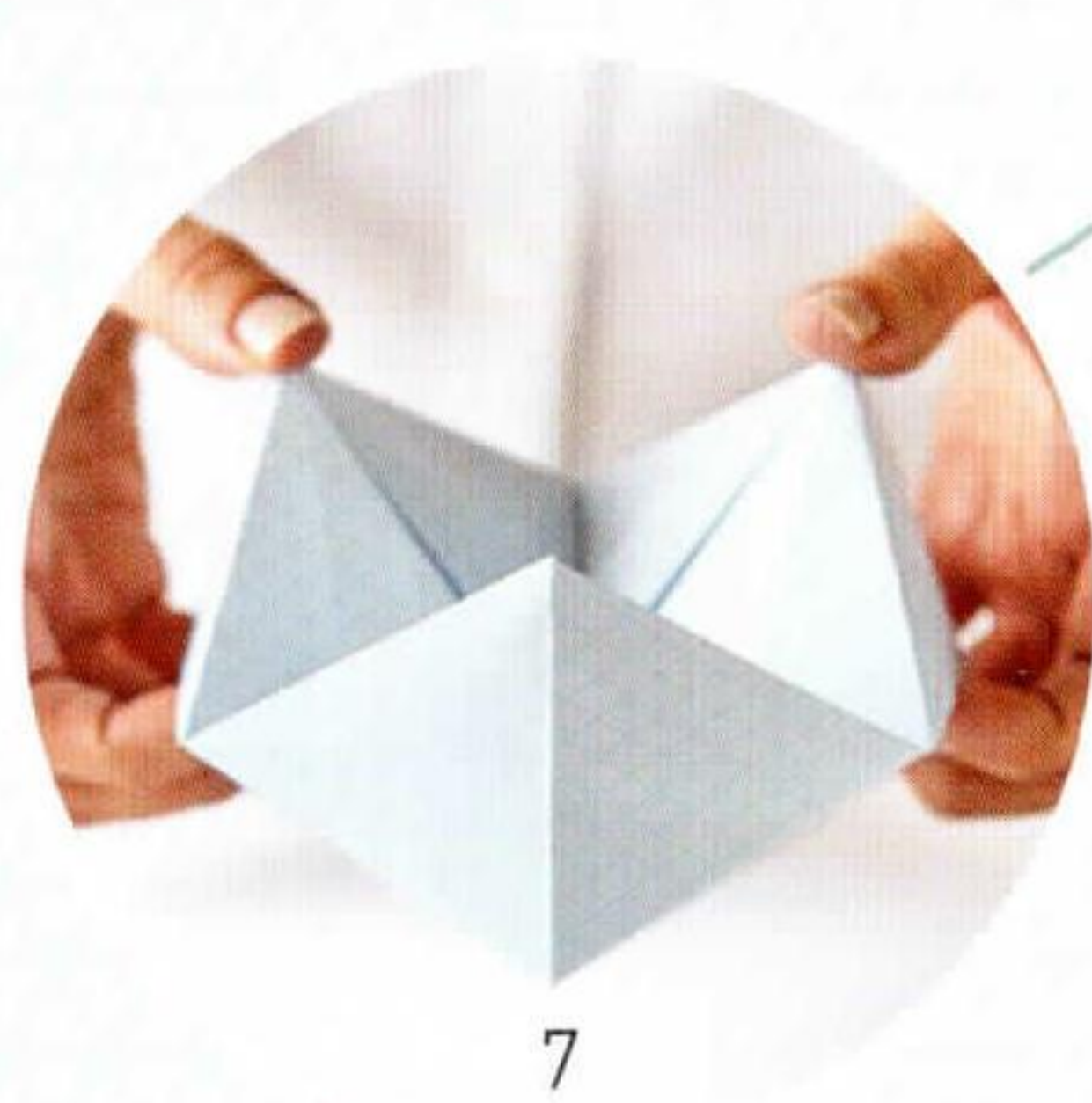
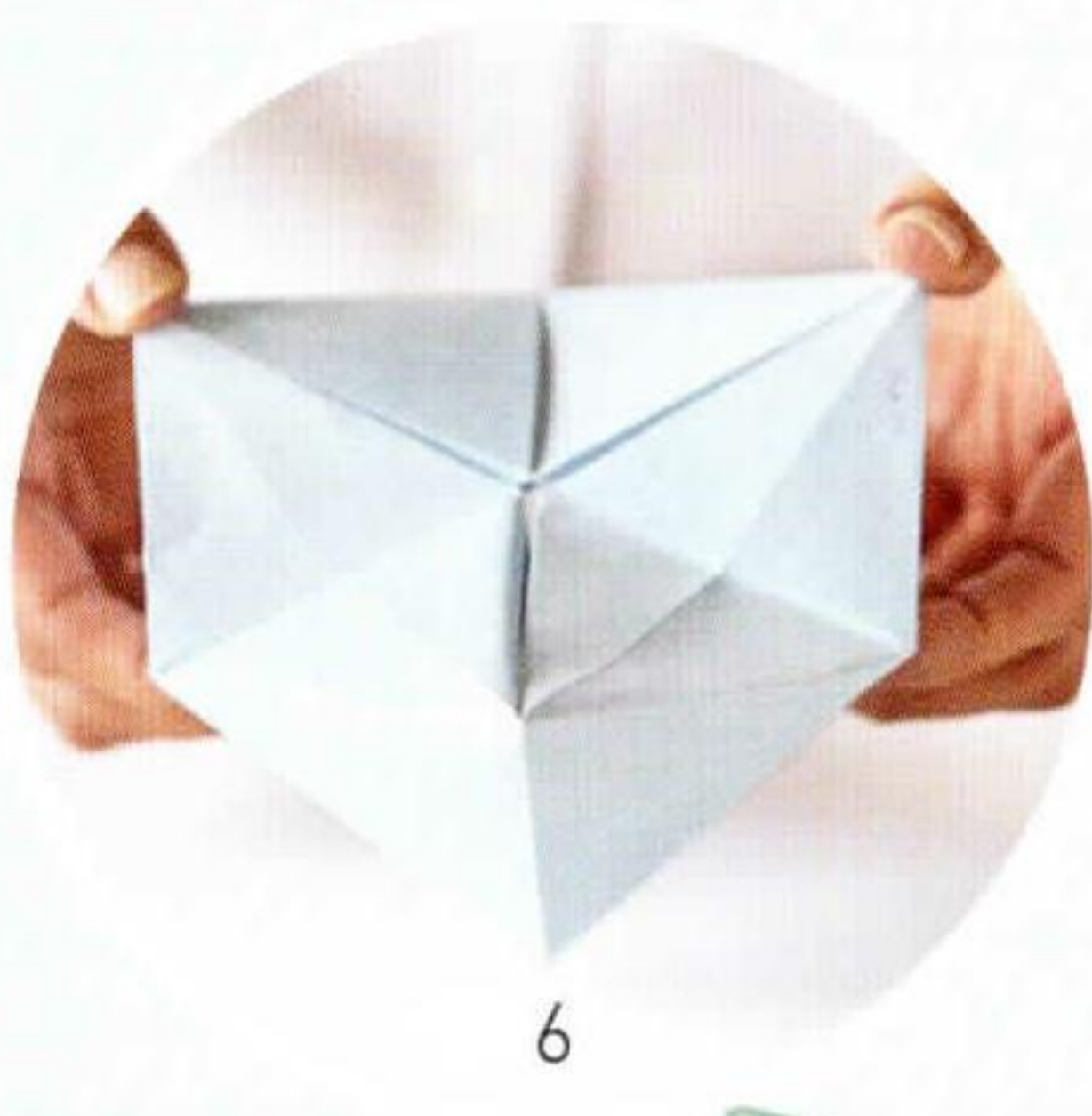
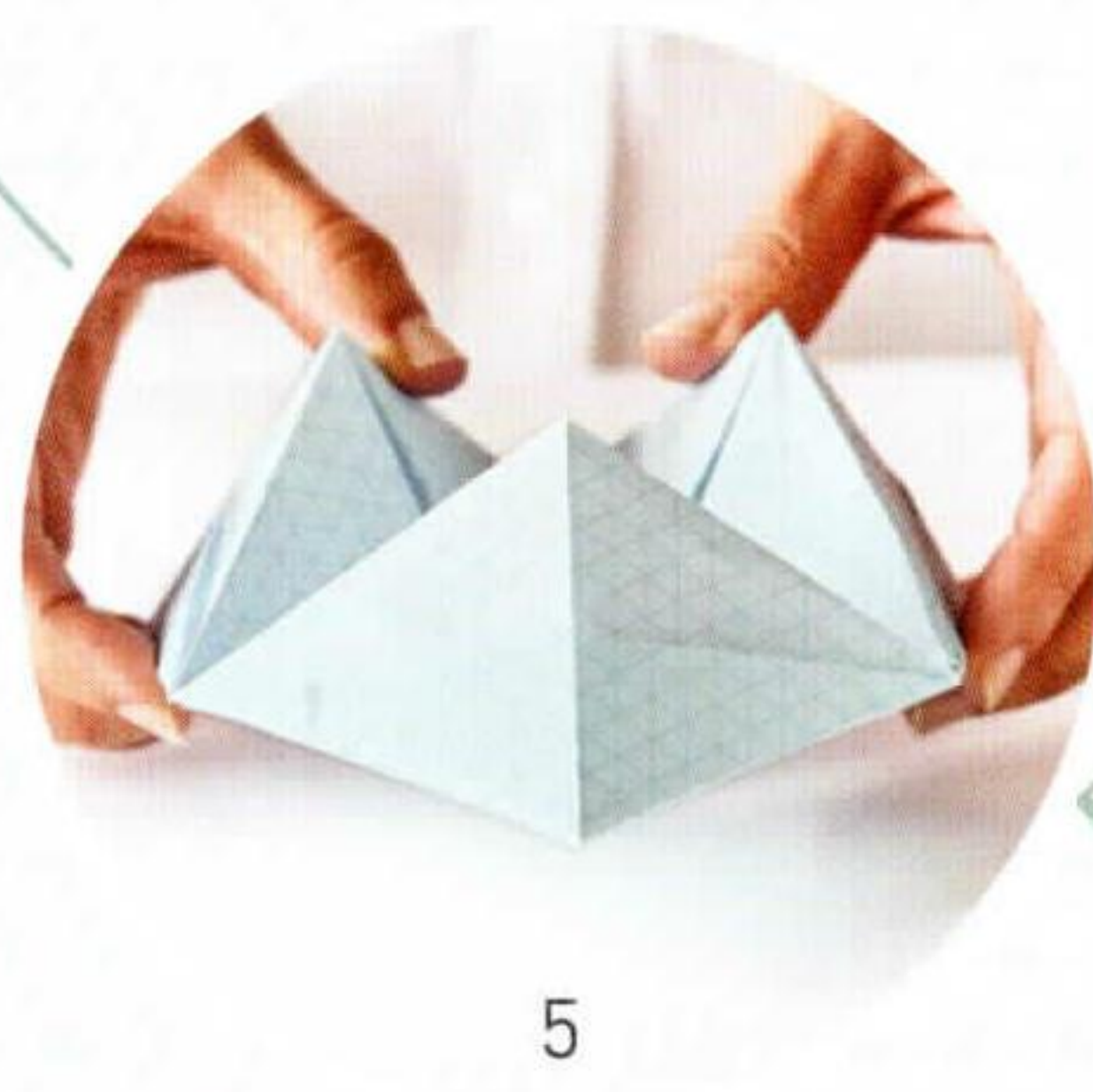
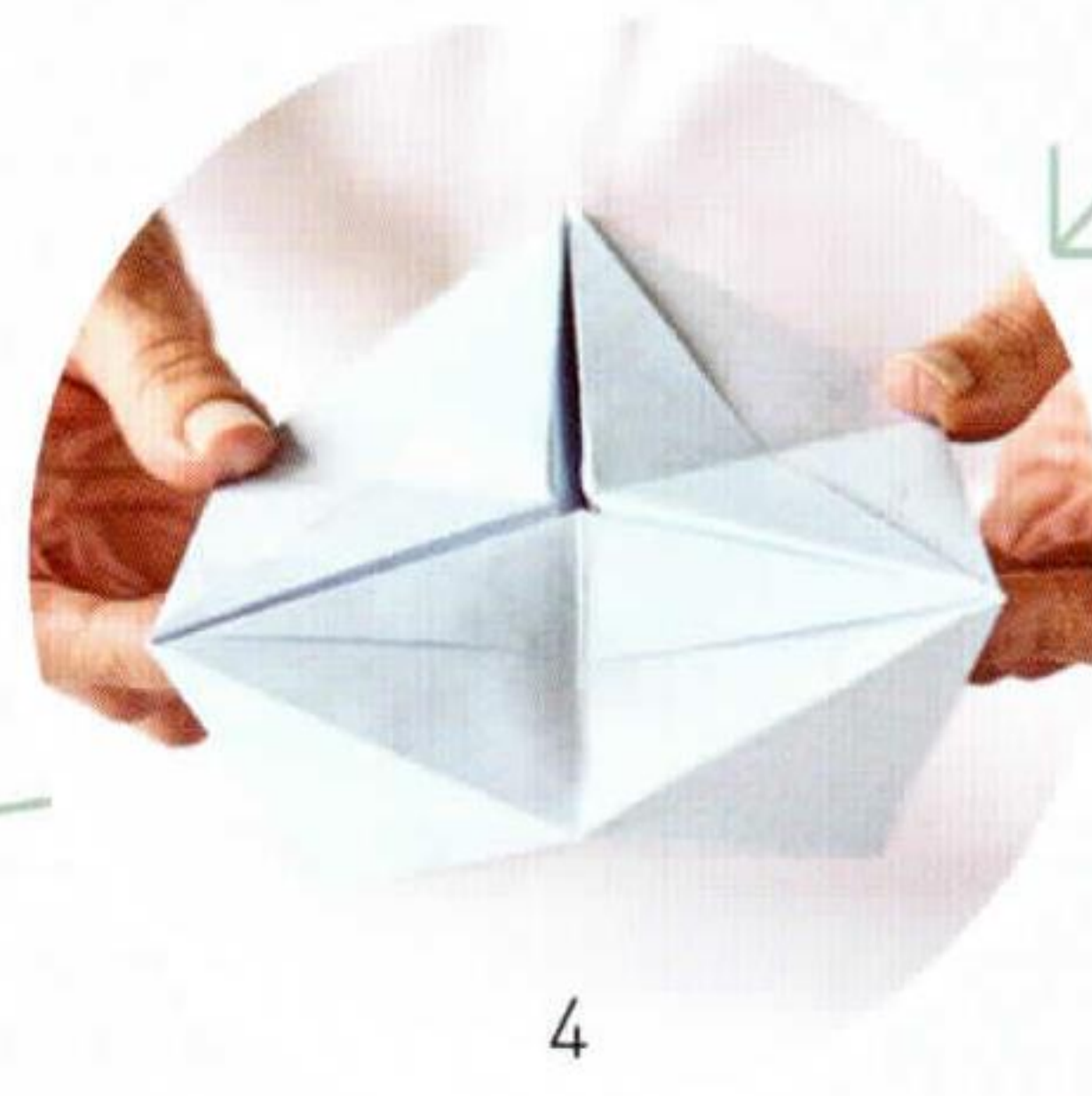
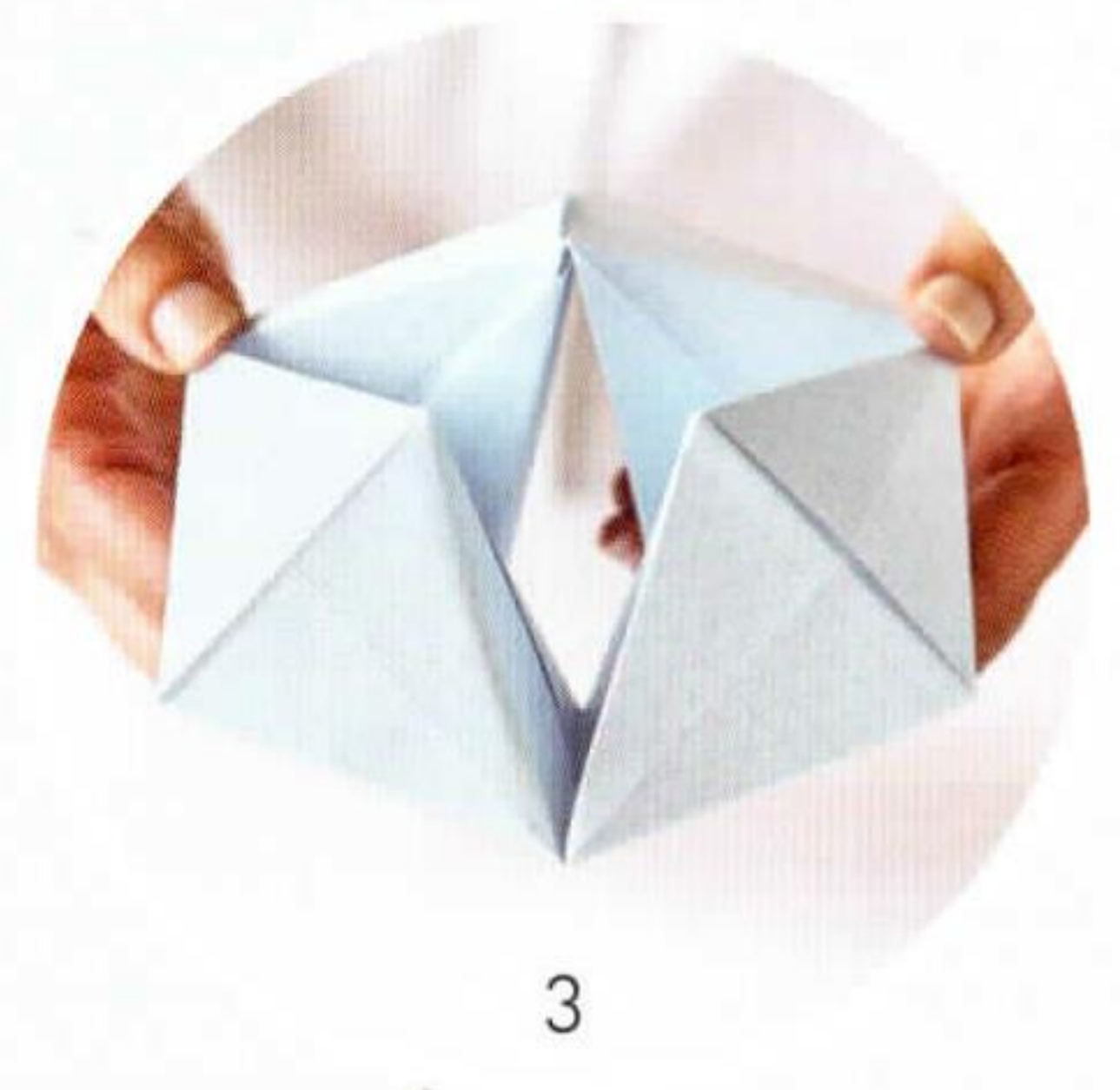

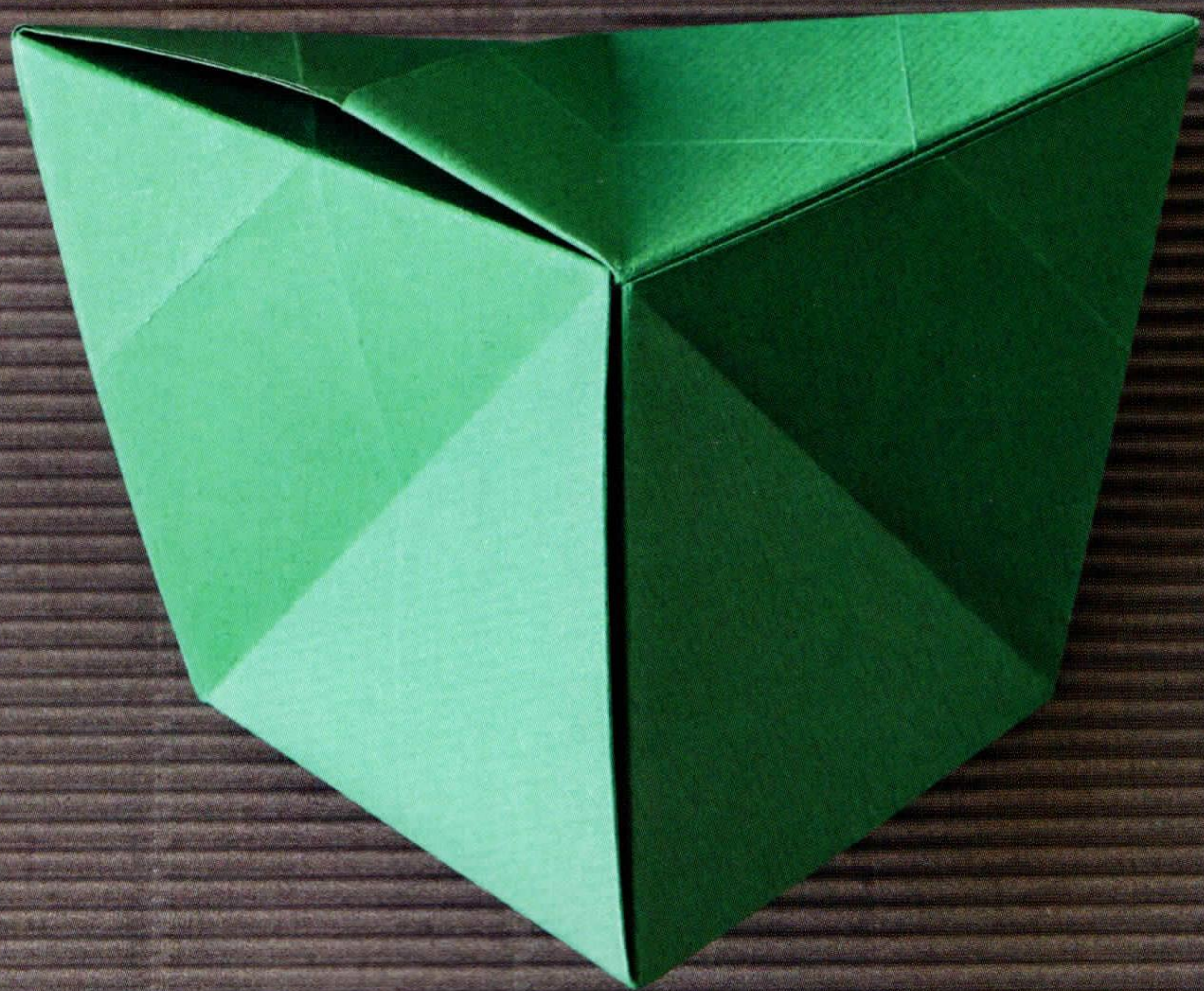
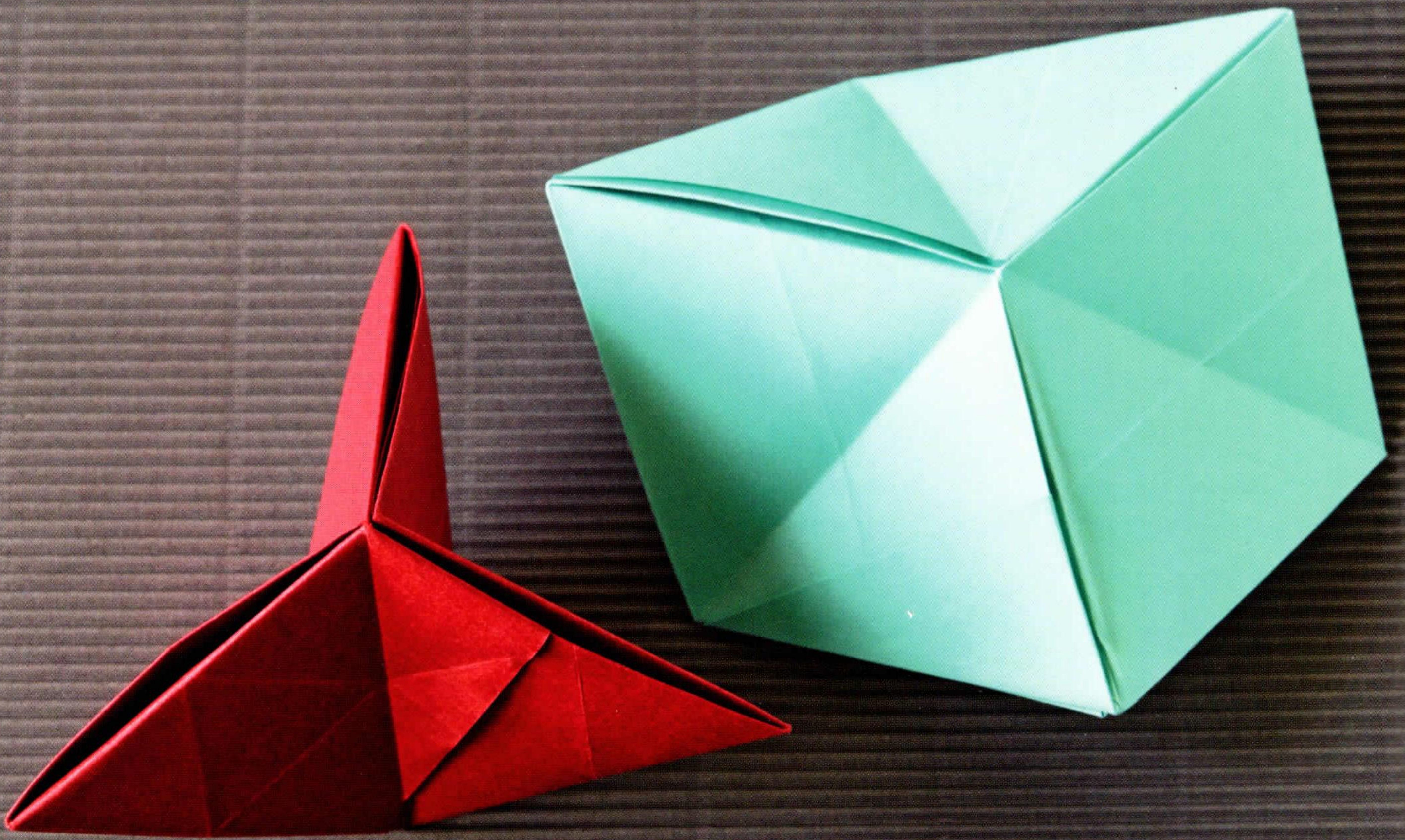

Flexagon Two

**

The second flexagon shares the same properties as the first flexagon in that it can be rotated. However, it is made from a series of connected equilateral triangles.

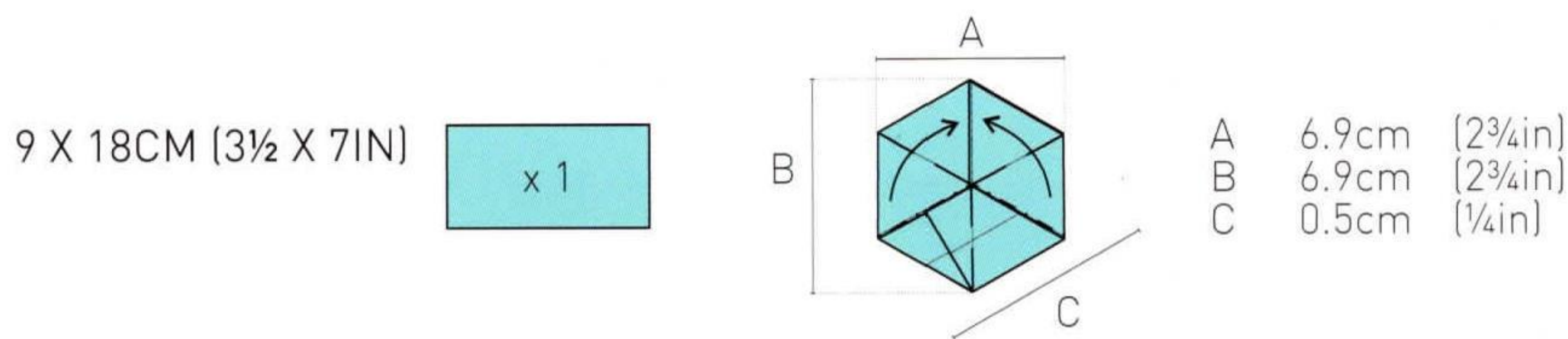

START WITH A 2 X 1 RECTANGLE, COLOURED SIDE DOWN.

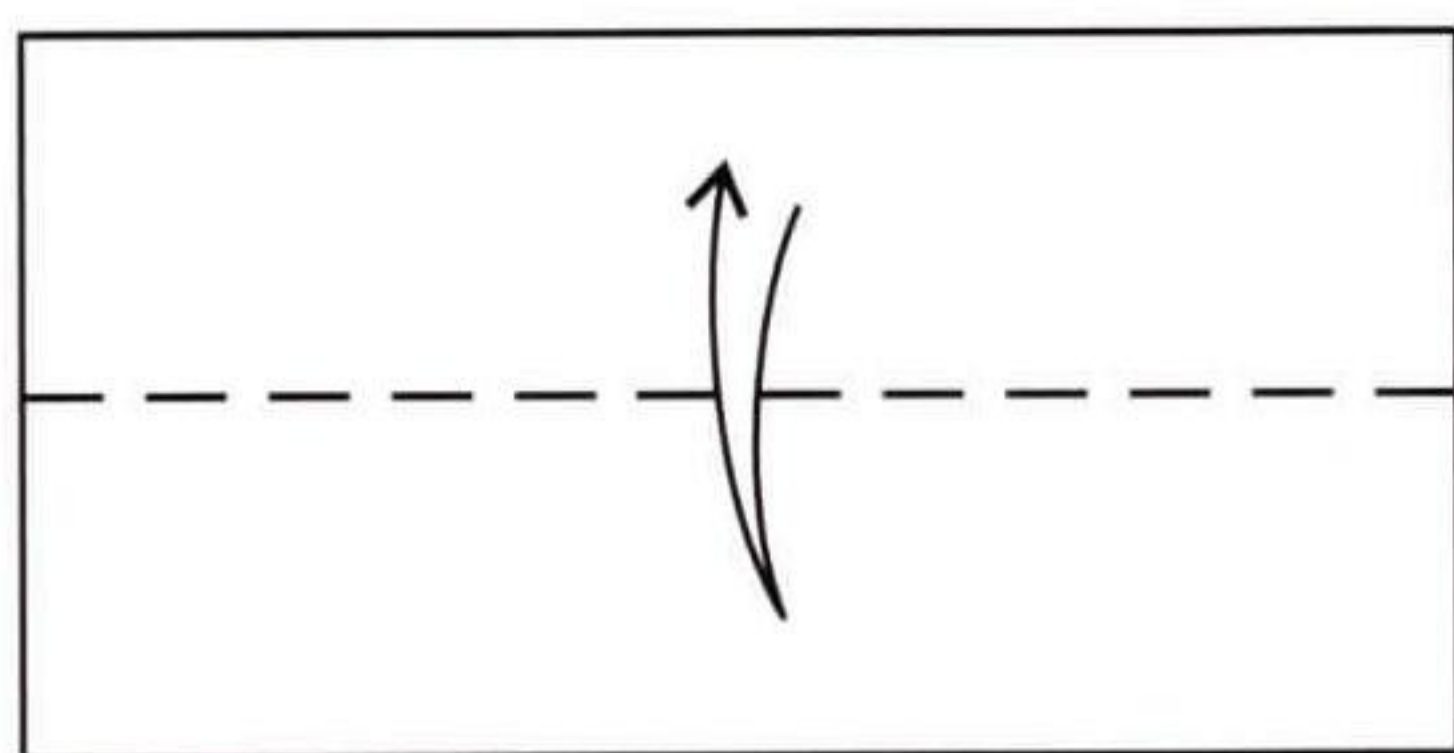

1 Fold and unfold the rectangle in half lengthwise.

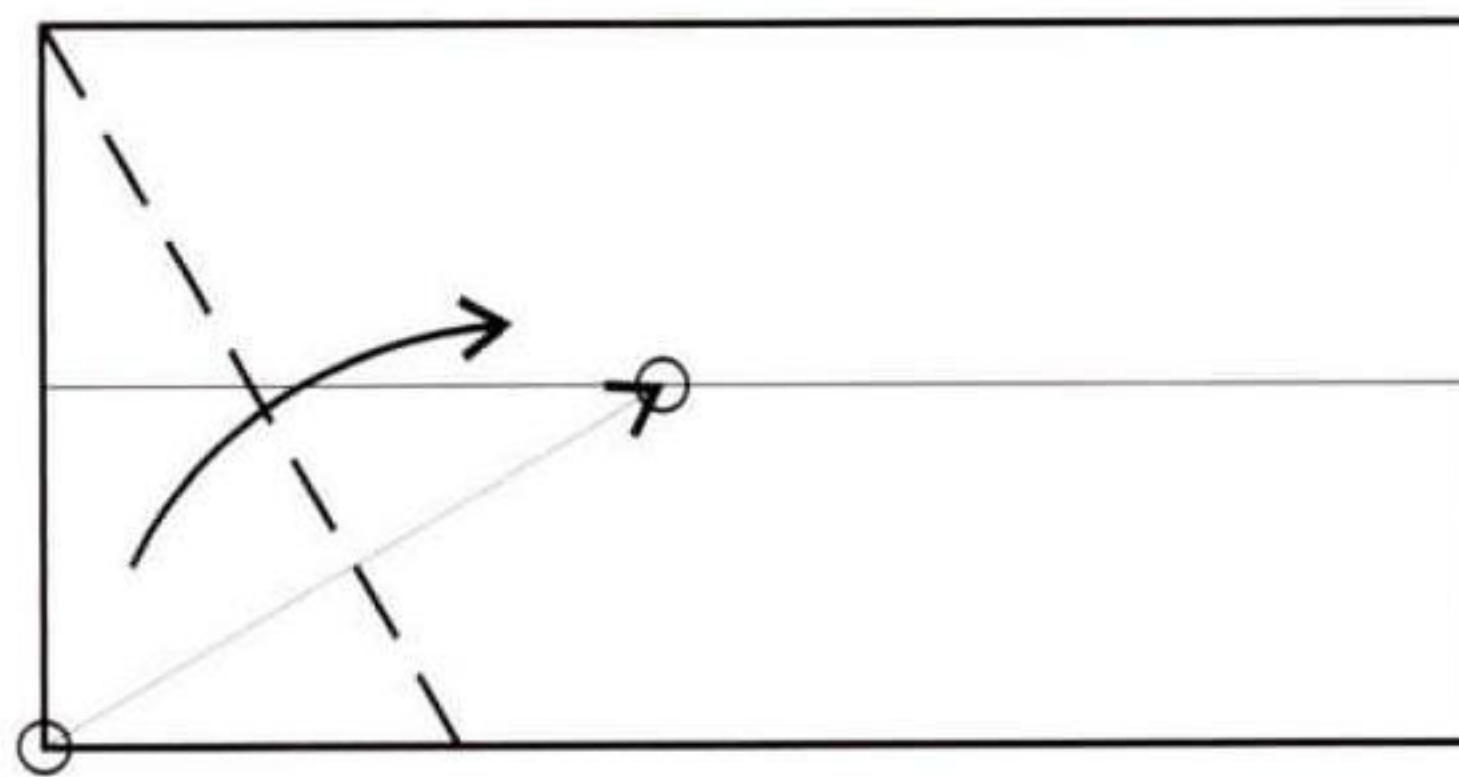

2 Fold the lower left corner up to touch the middle crease. The fold should start from the opposite corner.

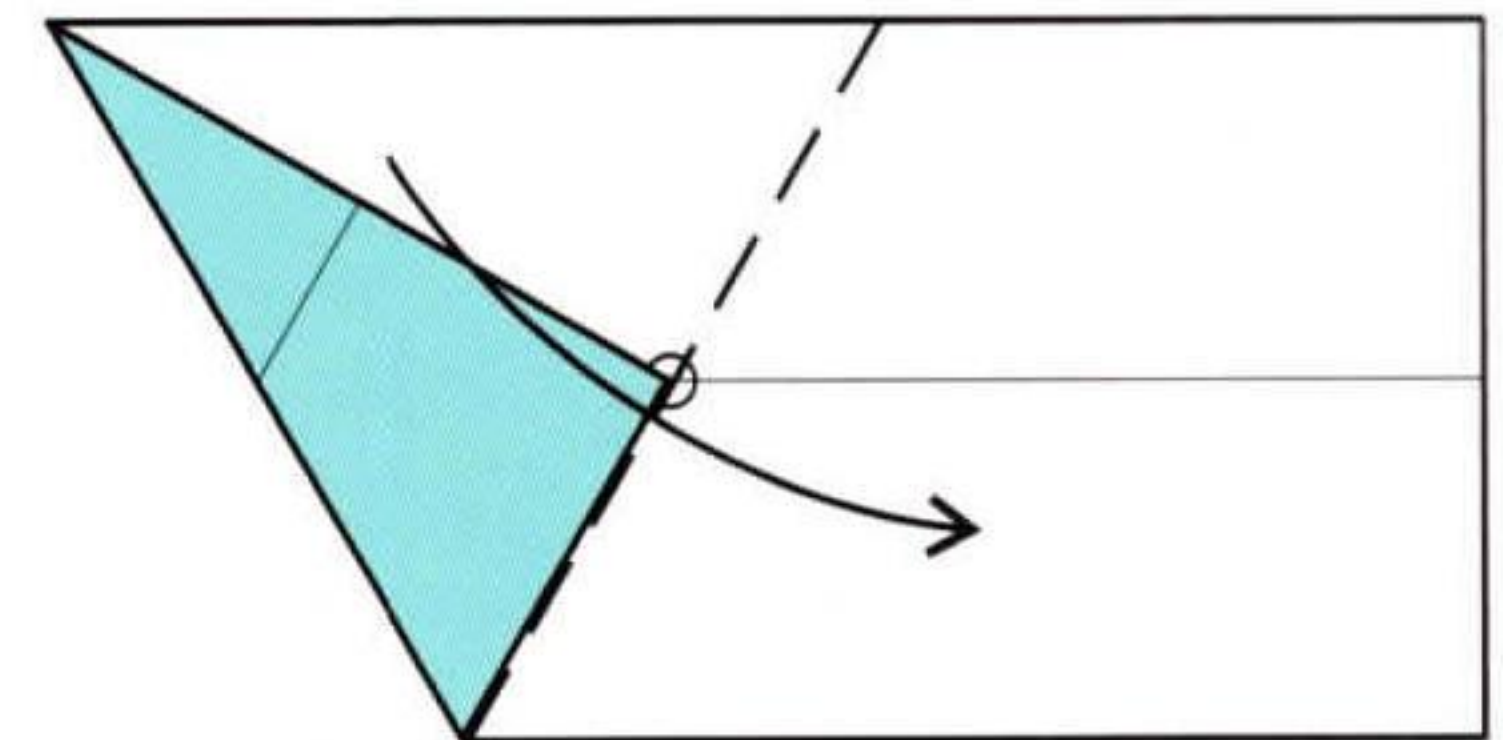

3 Fold the outer section over the edge of the folded corner.

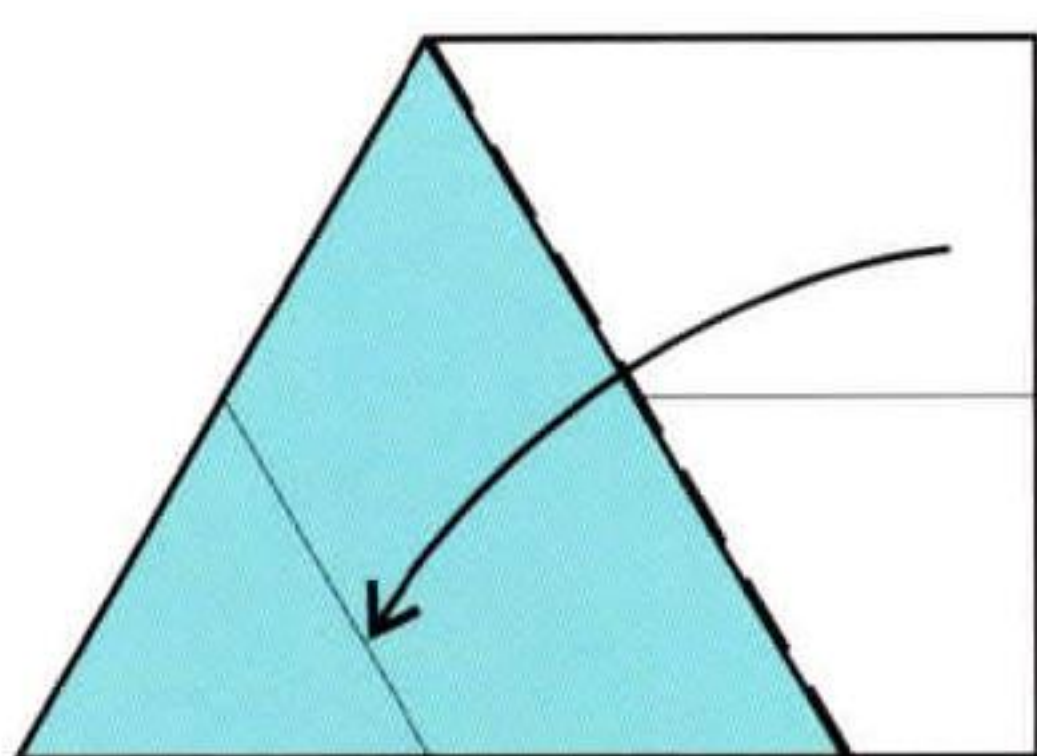

4 Fold the right side over along the edge.

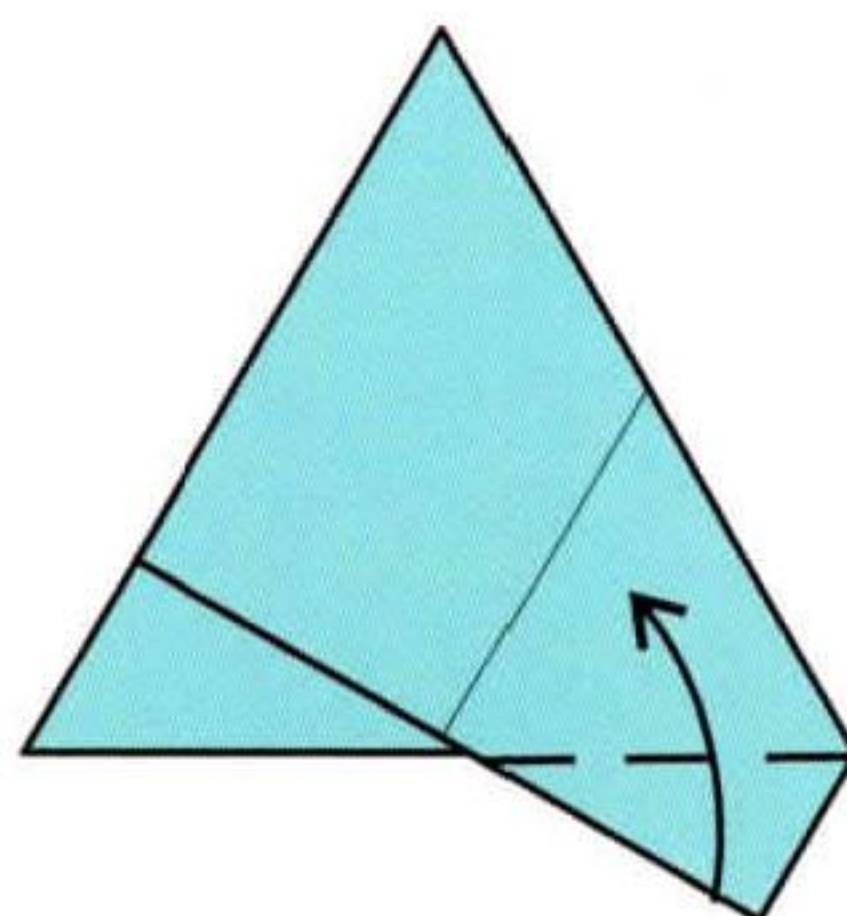

5 Fold the lower corner up so it is level with the folded edge beneath.

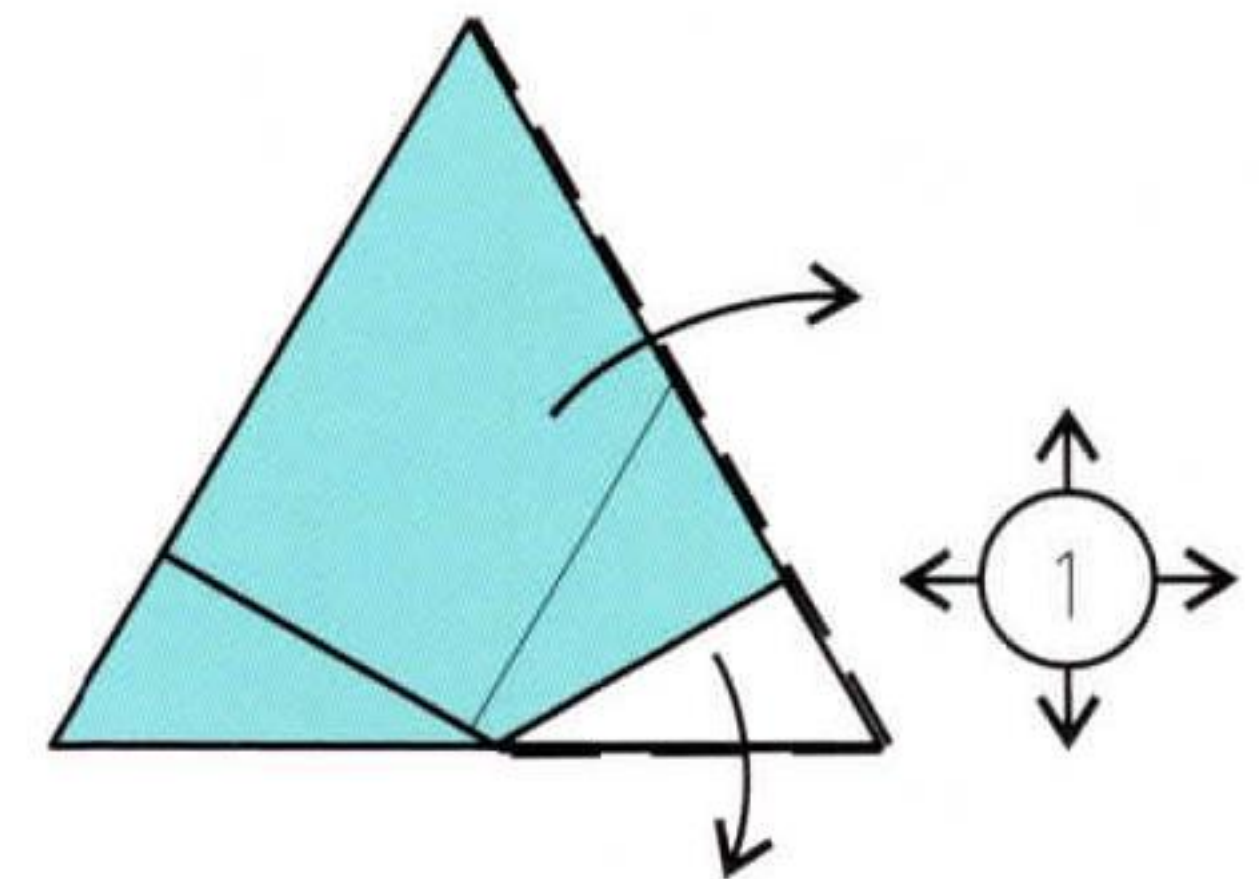

6 Unfold the model to step 1.

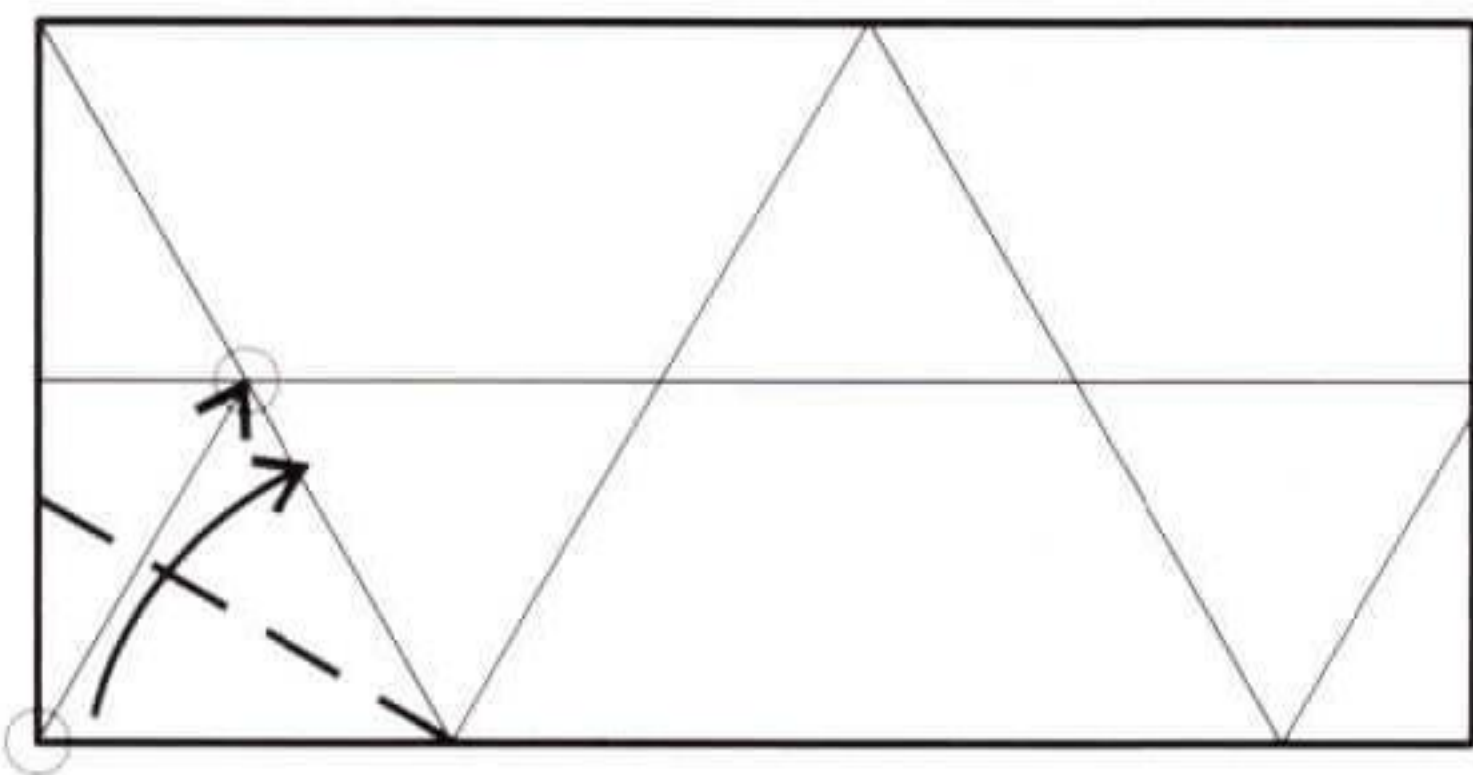

7 Fold the outer corner in to align the edge with the adjacent crease.

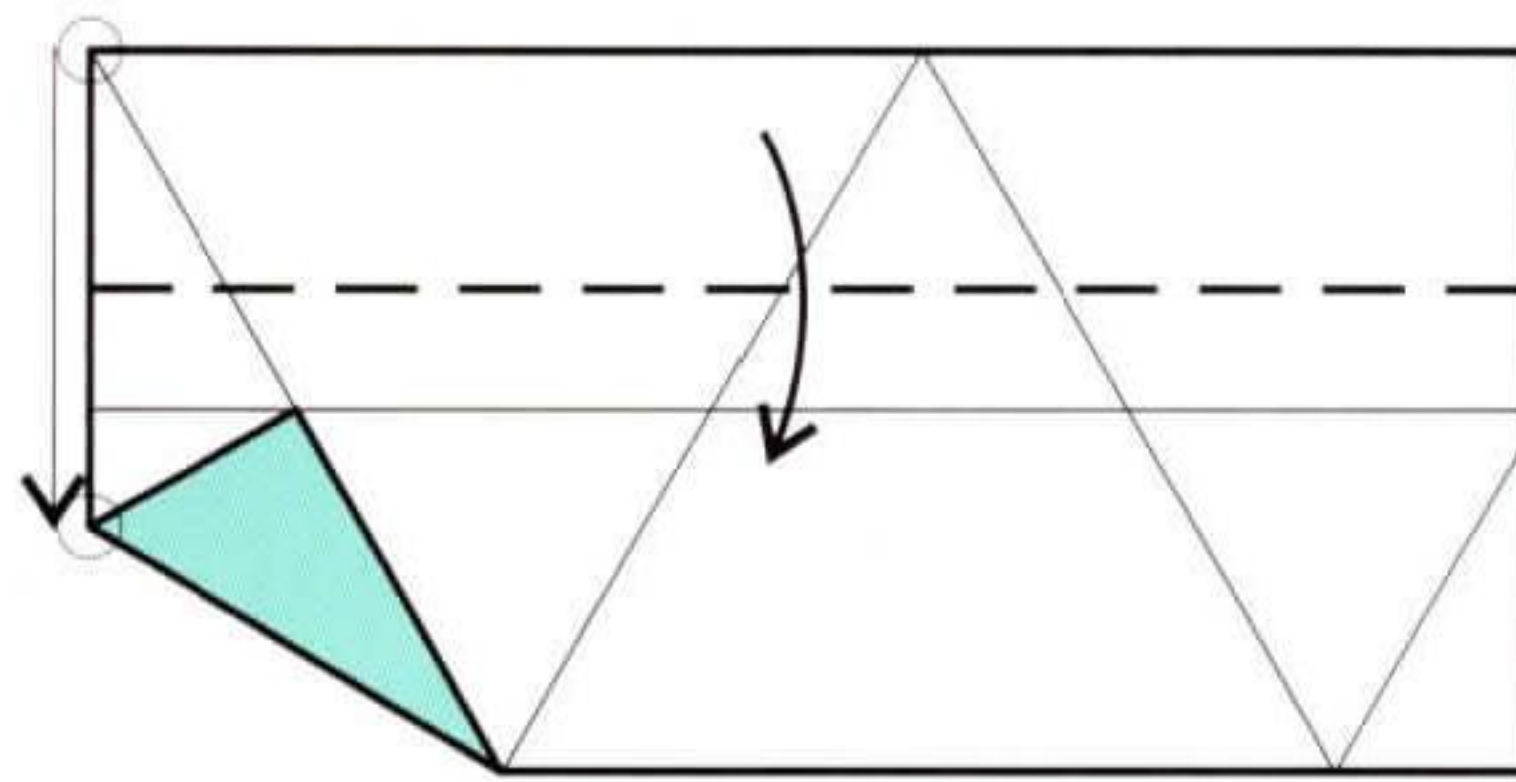

8 Fold the upper edge down to align with the outer point of the folded corner.

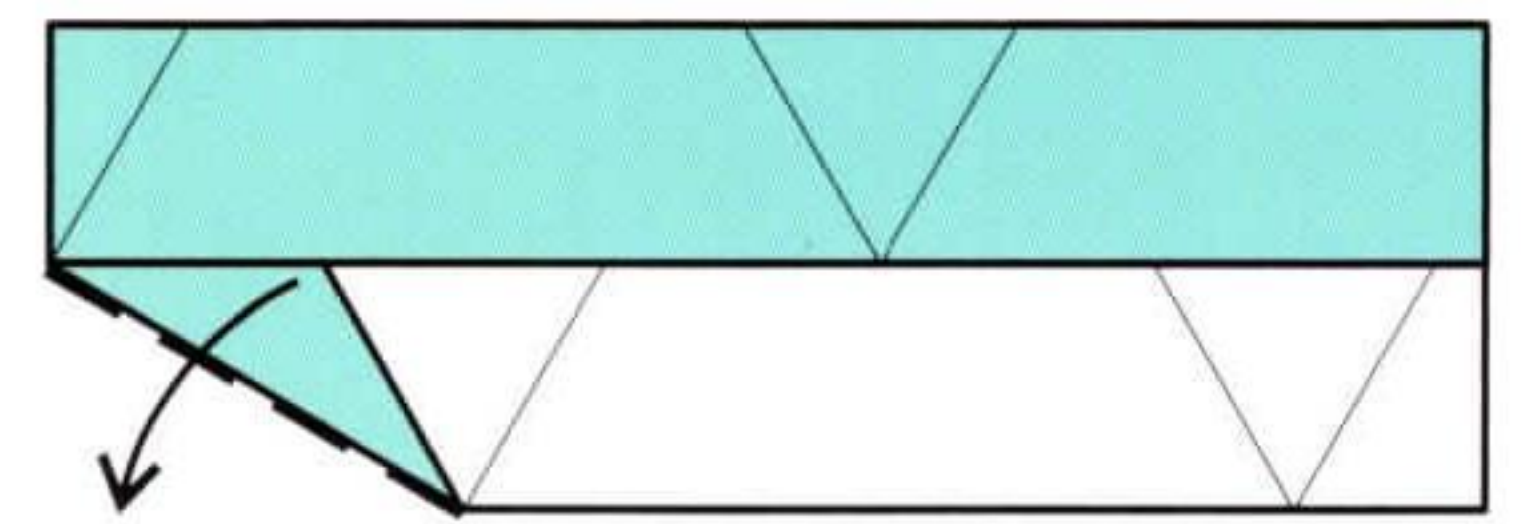

9 Unfold the corner folded in step 7.

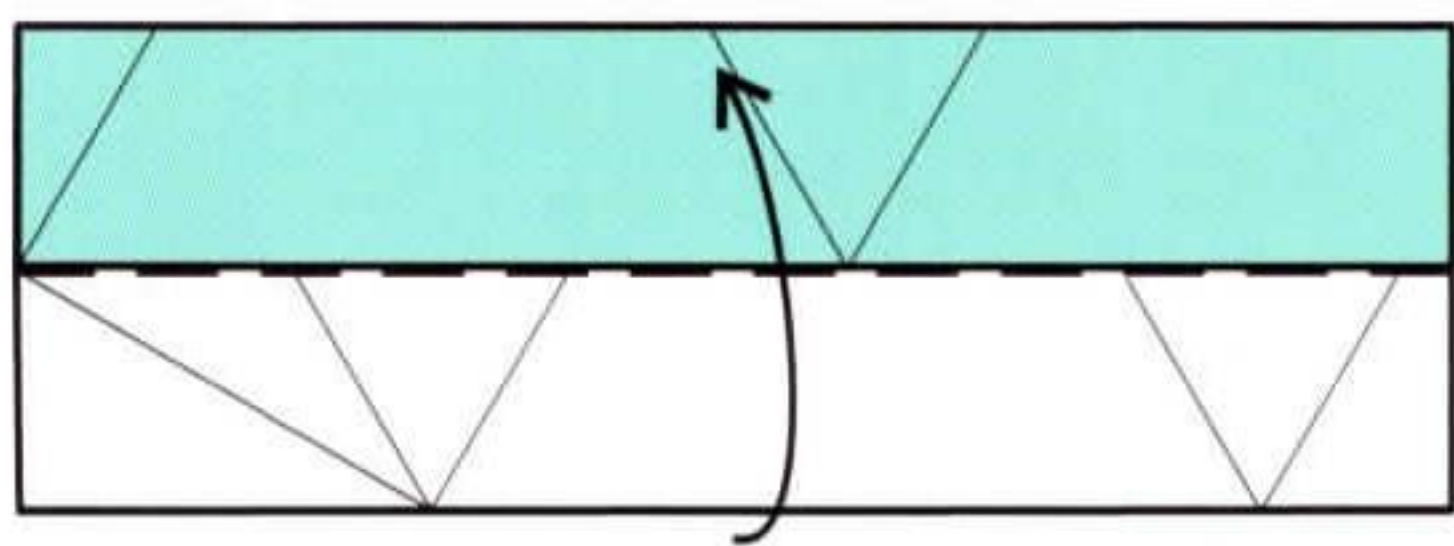

10 Fold the lower edge up.

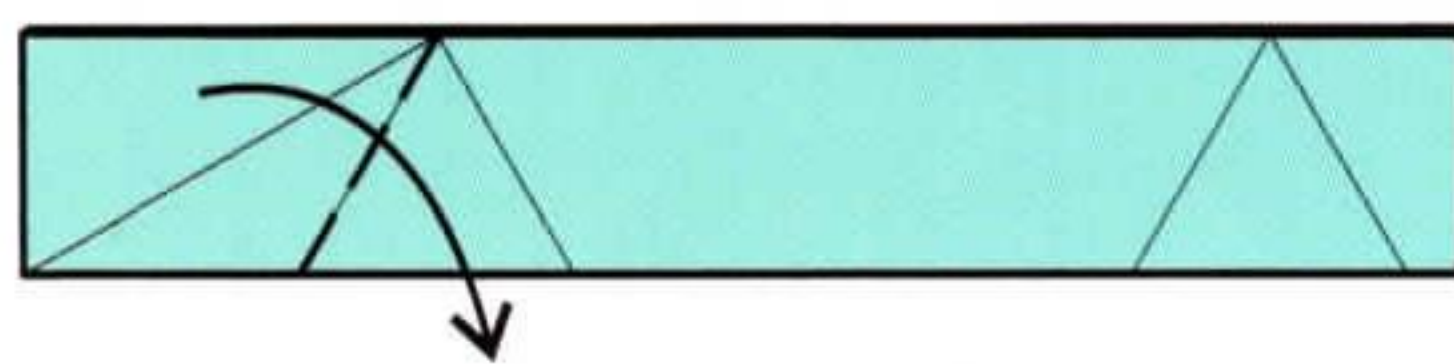

11 Fold the left side over along the crease made previously.

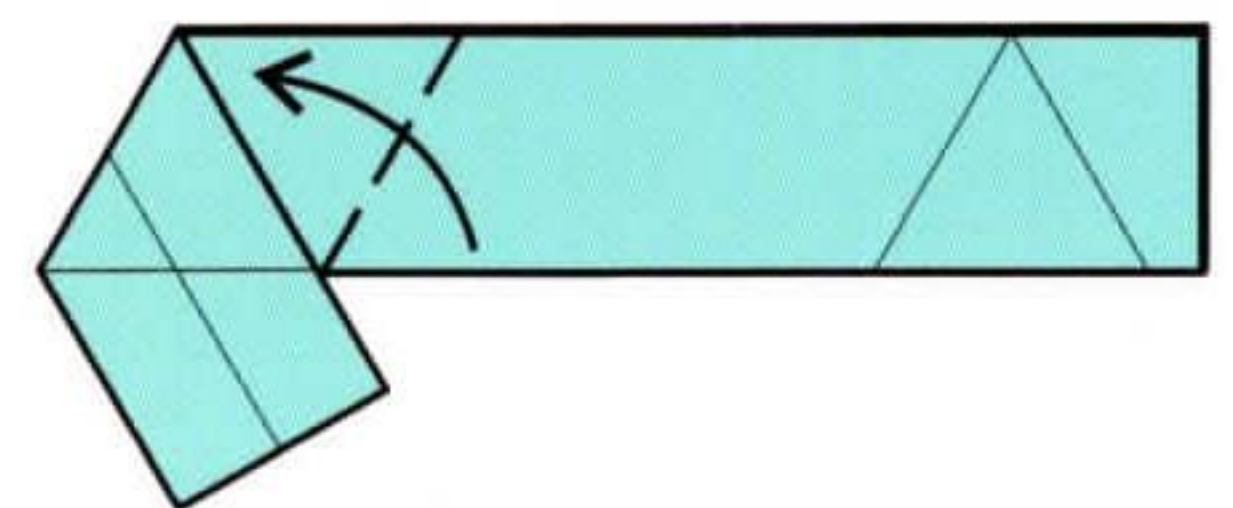

12 Fold the opposite side up to be parallel to the adjacent folded section.

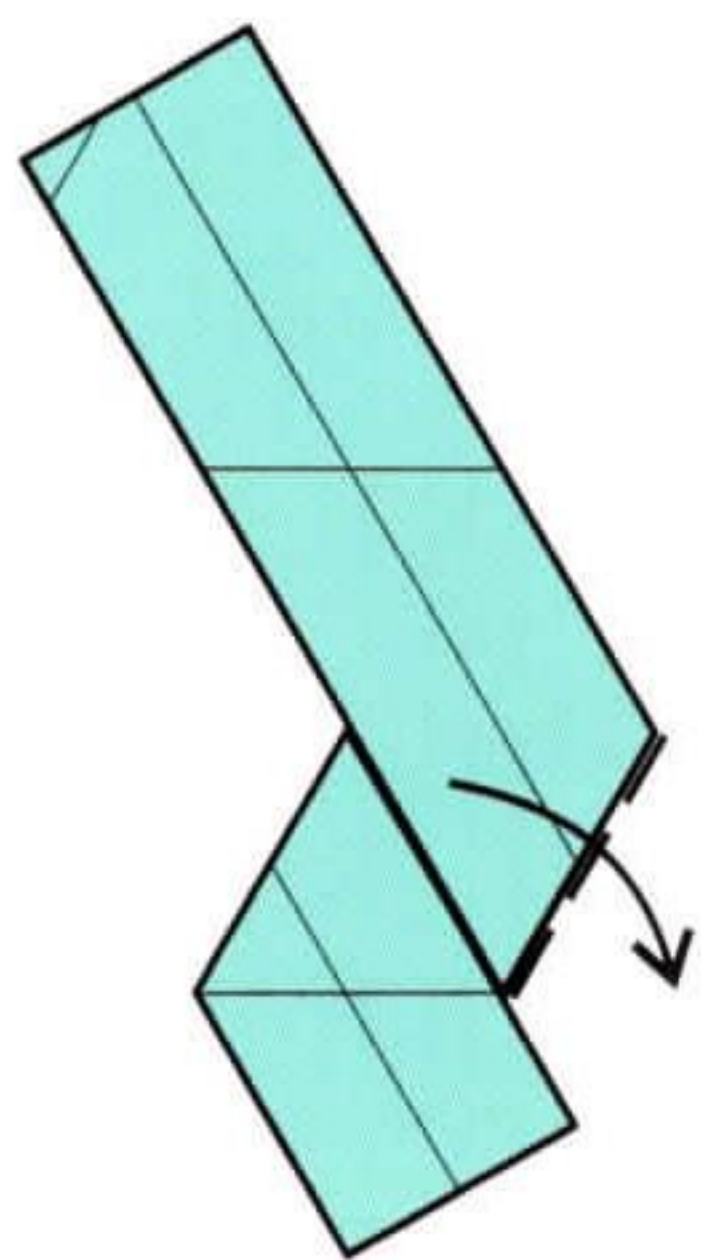

13 Unfold the previous step.

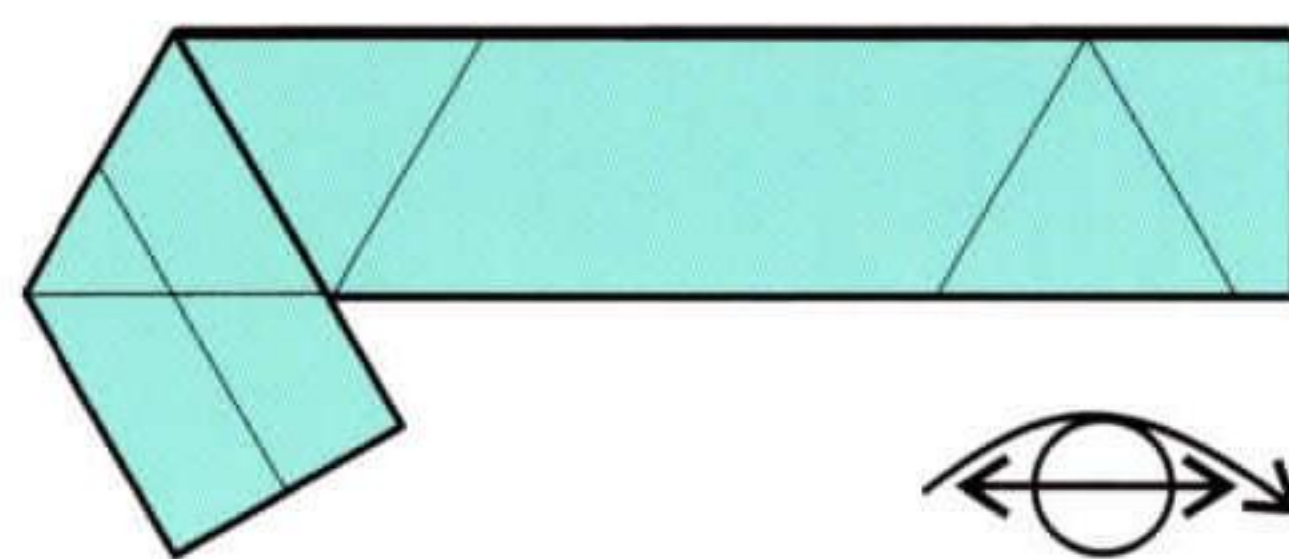

14 Turn the model over, left to right.

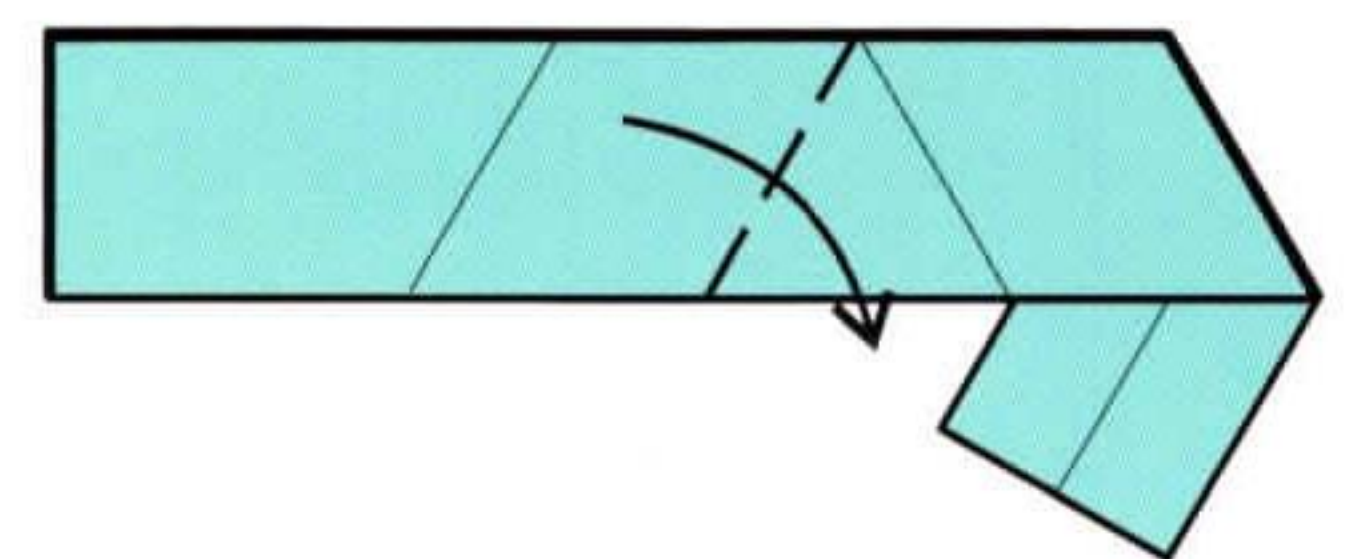

15 Fold the left section over so it is aligned with the adjacent crease.

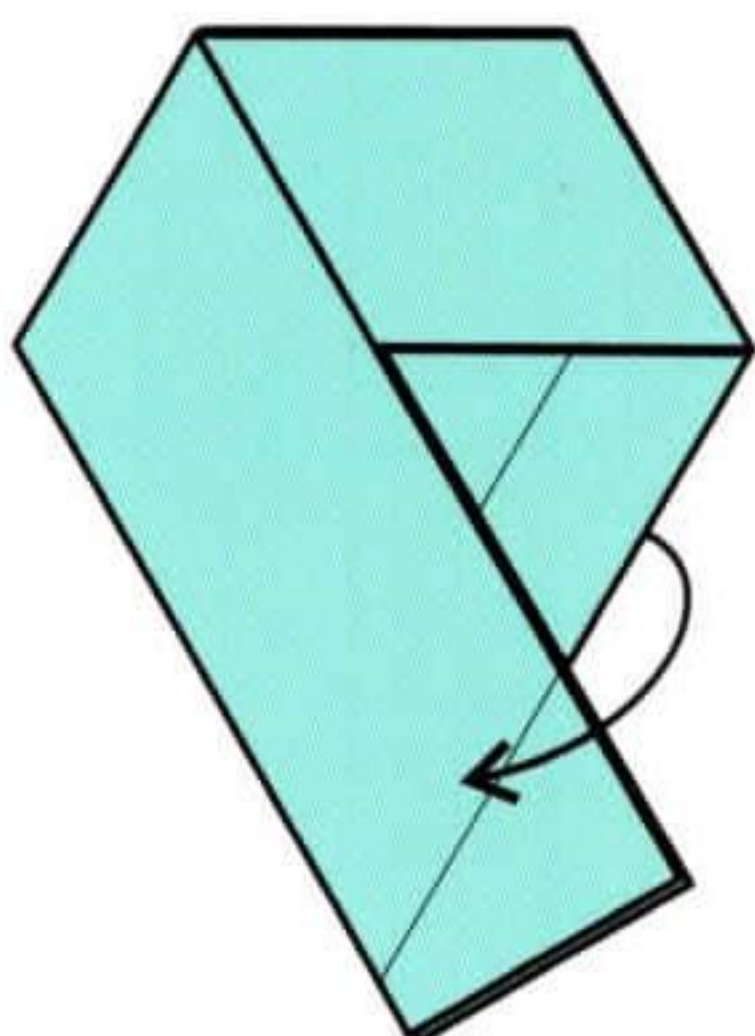

16 Move the lower layer to the front above the folded section.

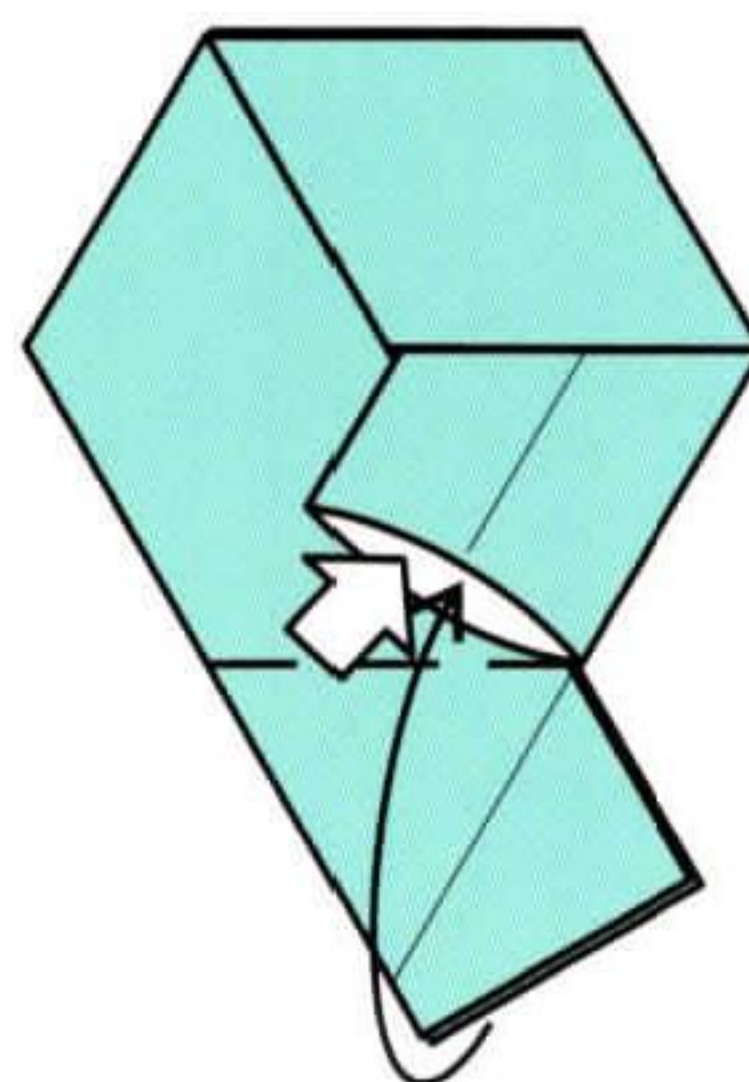

17 Fold the lower section up and tuck one end of the model into the other.

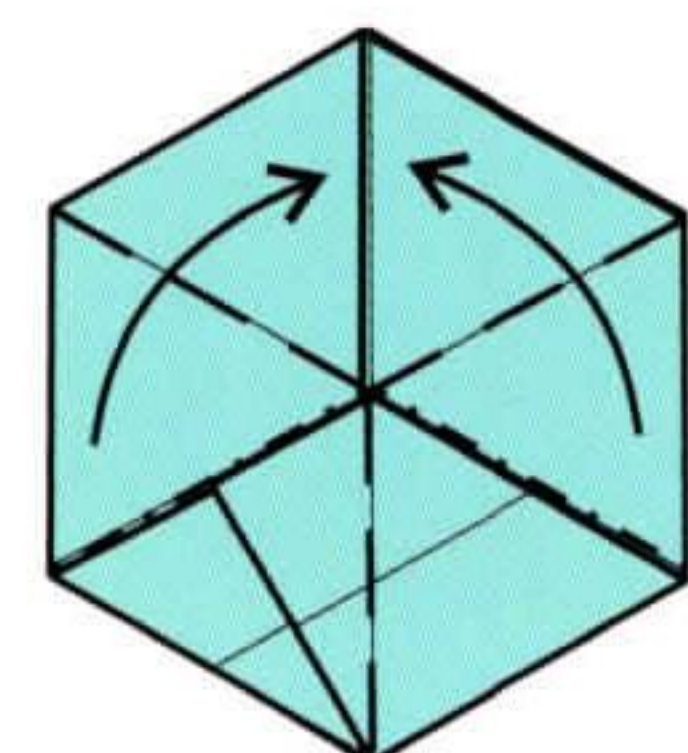

18 Fold the corners together. Completed.

ROTATING THE FLEXAGON

- (a) Hold the upper corners and pull them apart.
- (b) Continue opening out the hexagon until flat.
- (c) Then push up the middle.
- (d) Bring the inner point up and fold back to step (a).

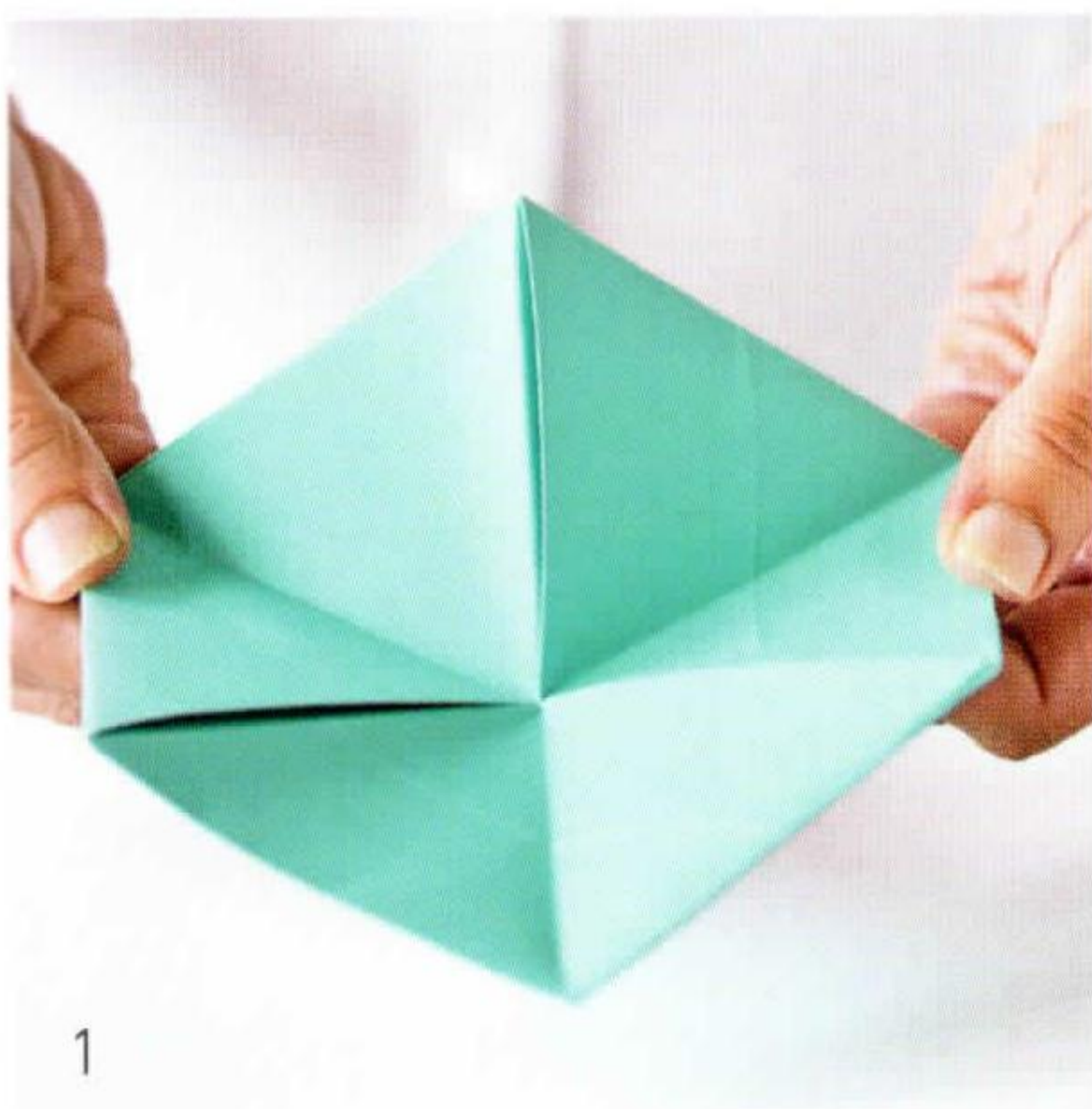
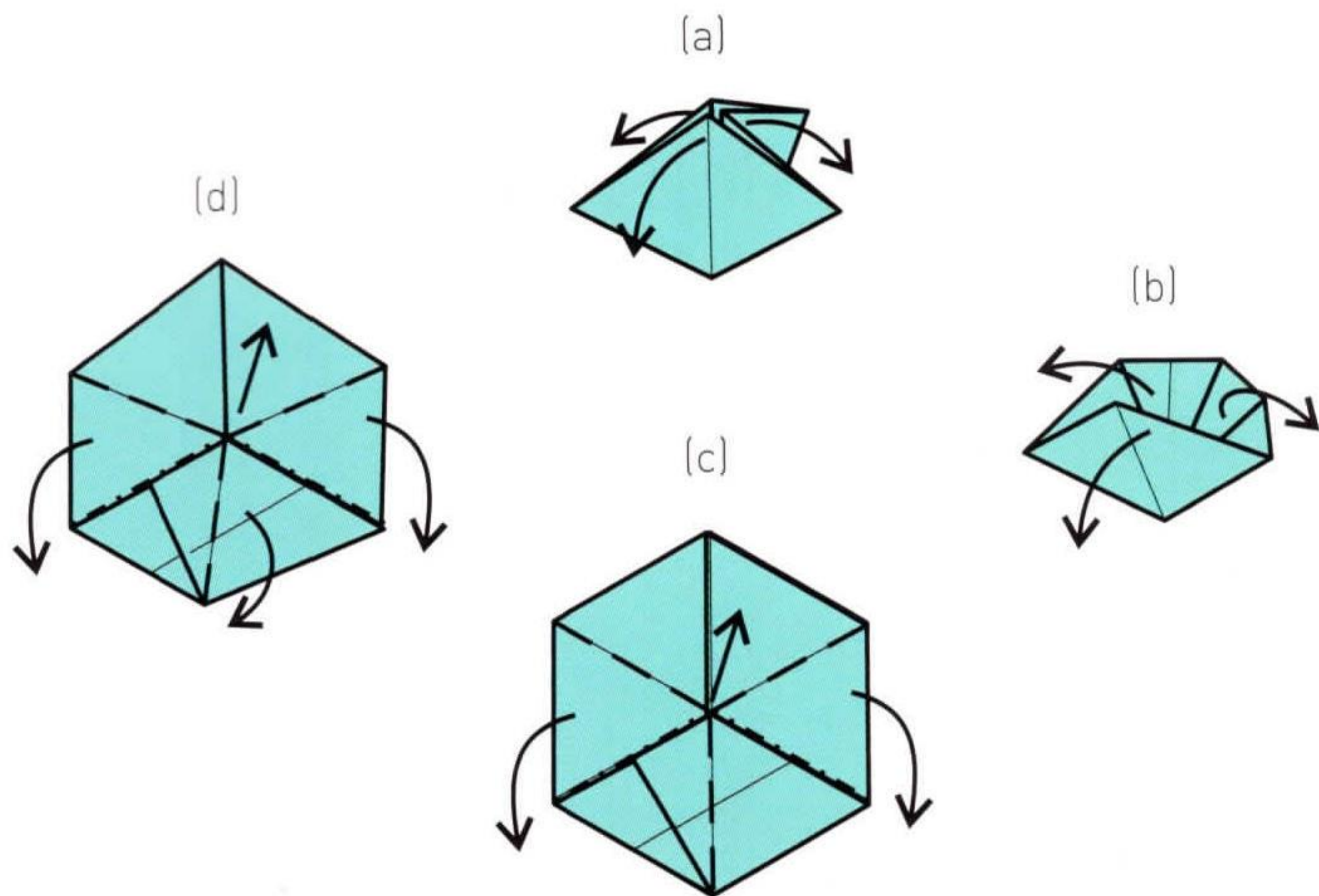

1
Fold the edges down causing the middle of the hexagon to rise up.

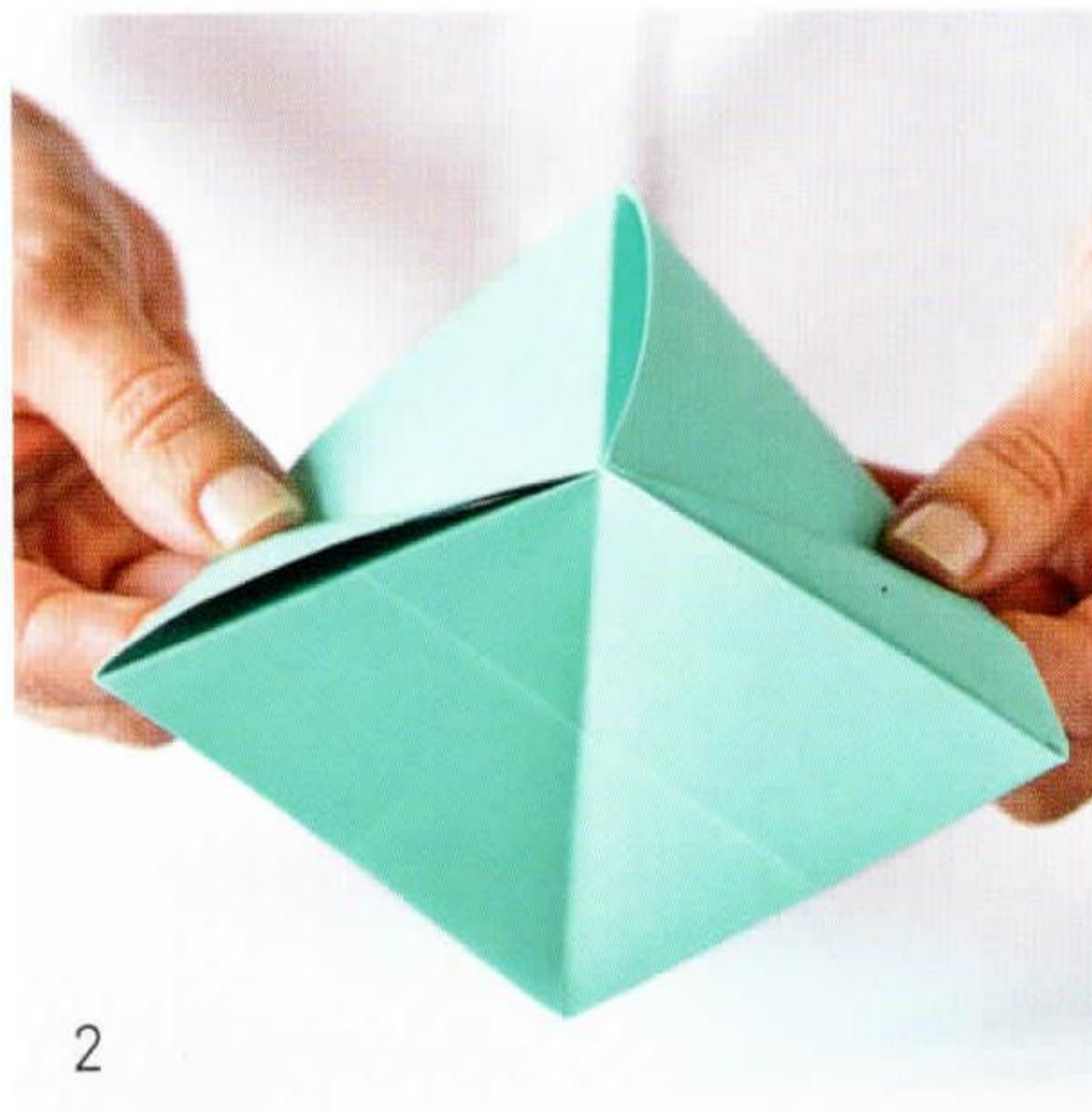

2
Continue folding the edges downwards and bring the triangular faces together.

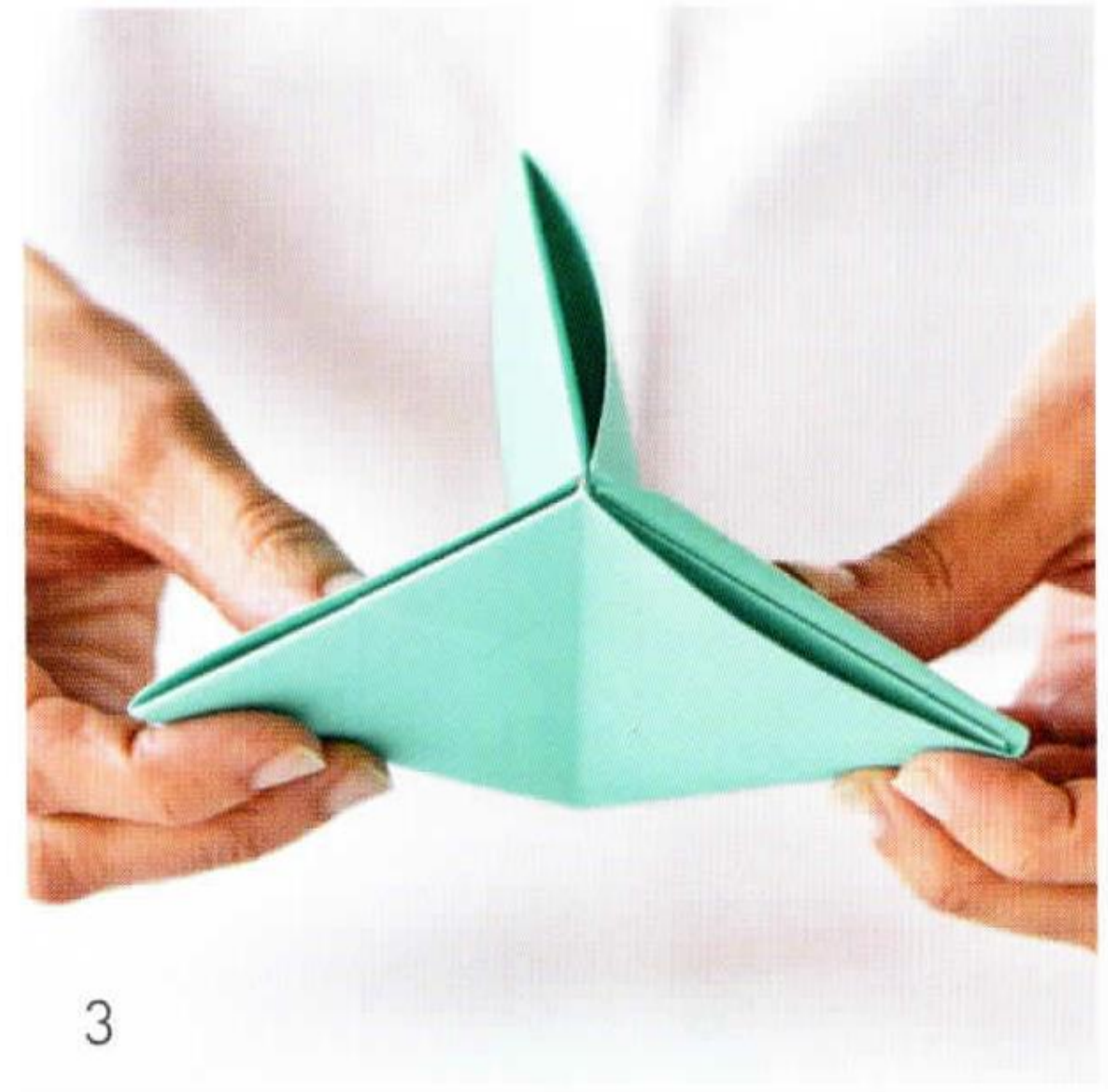

3
This will flatten the model. Now move your finger to the upper point. (This was the middle of the hexagon).

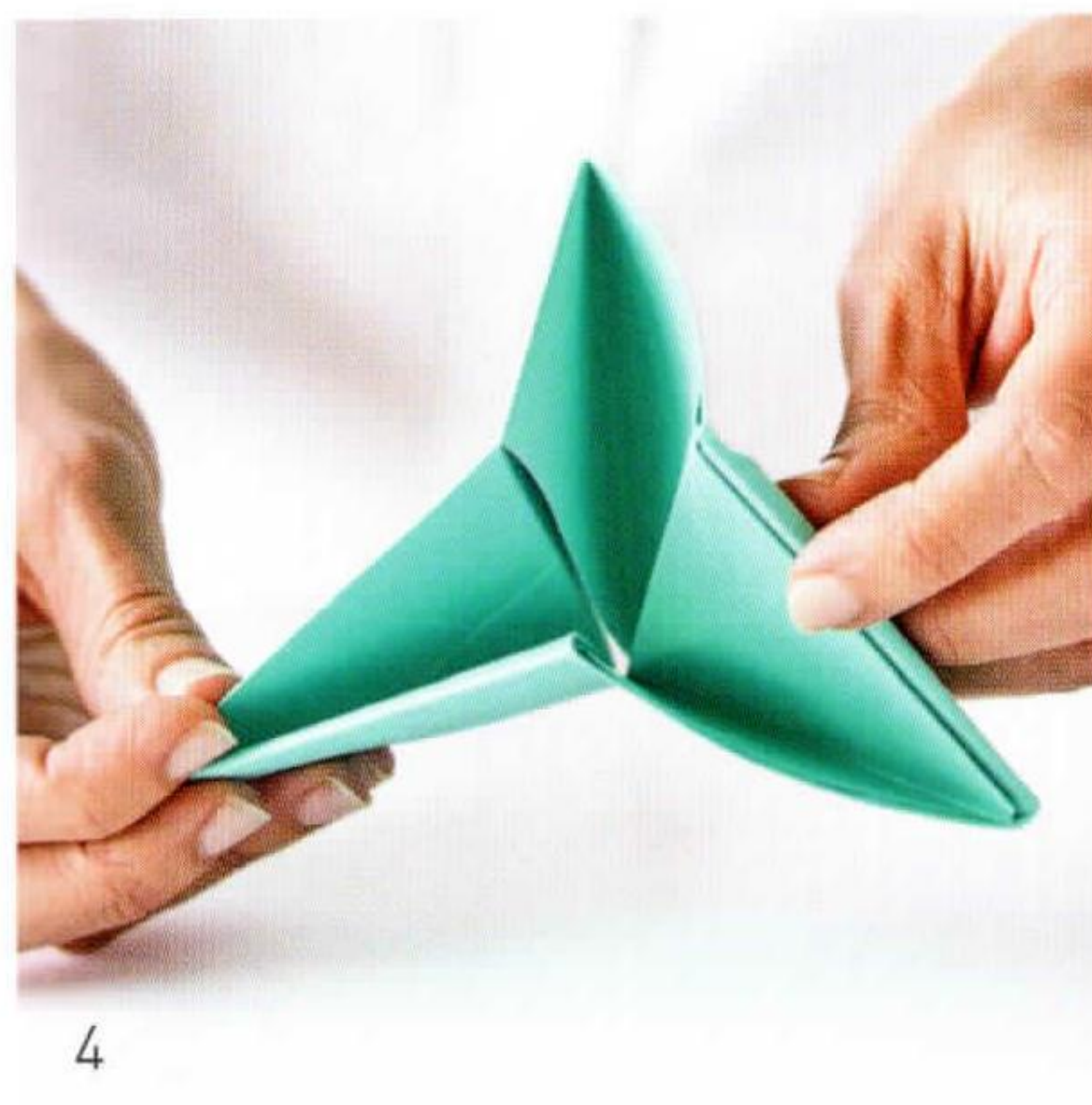

4
Holding the lower edges together pull apart the upper tips of the equilateral triangles.



5
Ease the triangular faces apart while holding the lower points together.

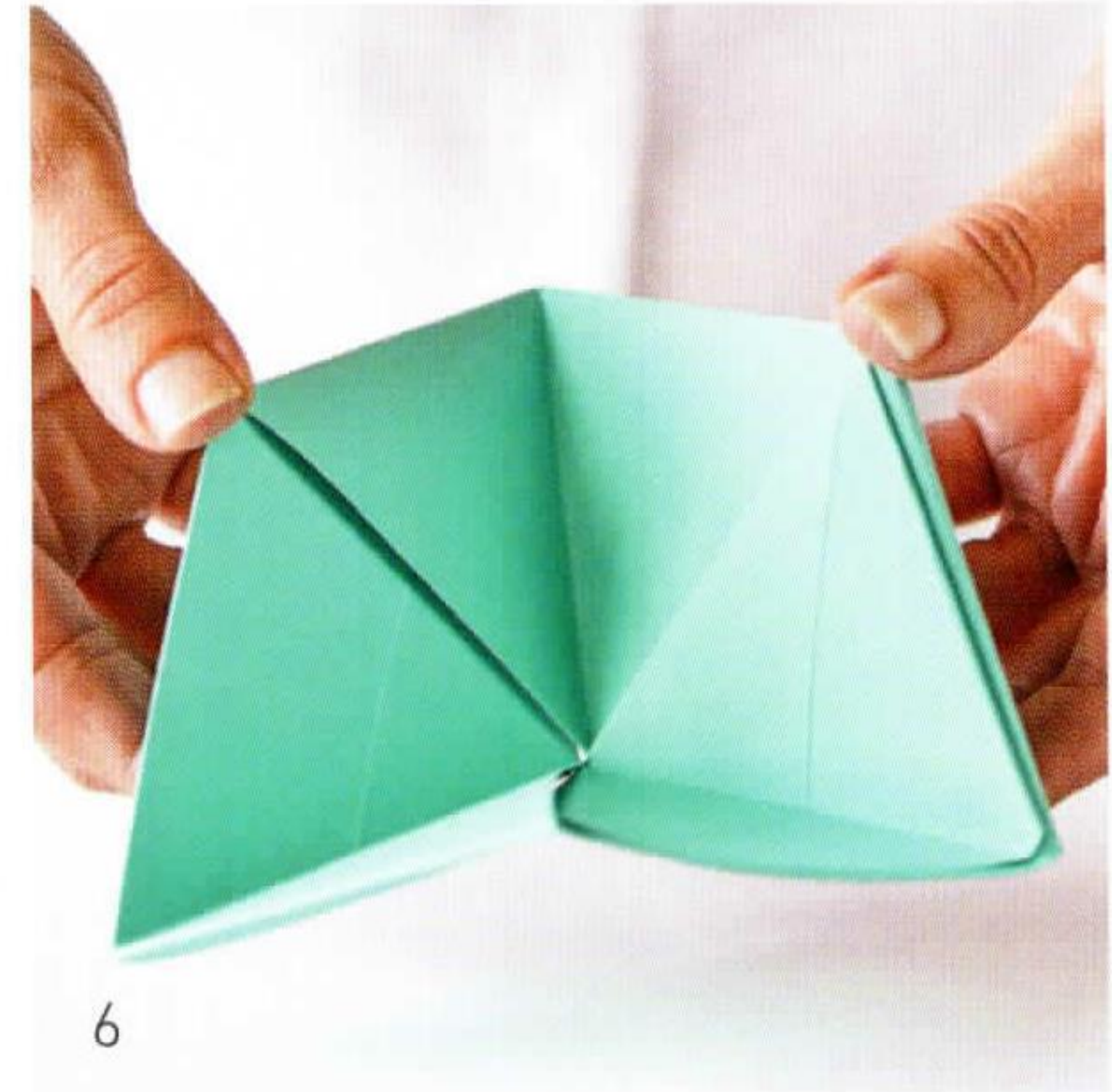

6
Open the face back to a hexagon (Step 1).

Twist Star

**

The twist star is built around a folding process that twists together the two sides of a square. This rotation fold will form a star.

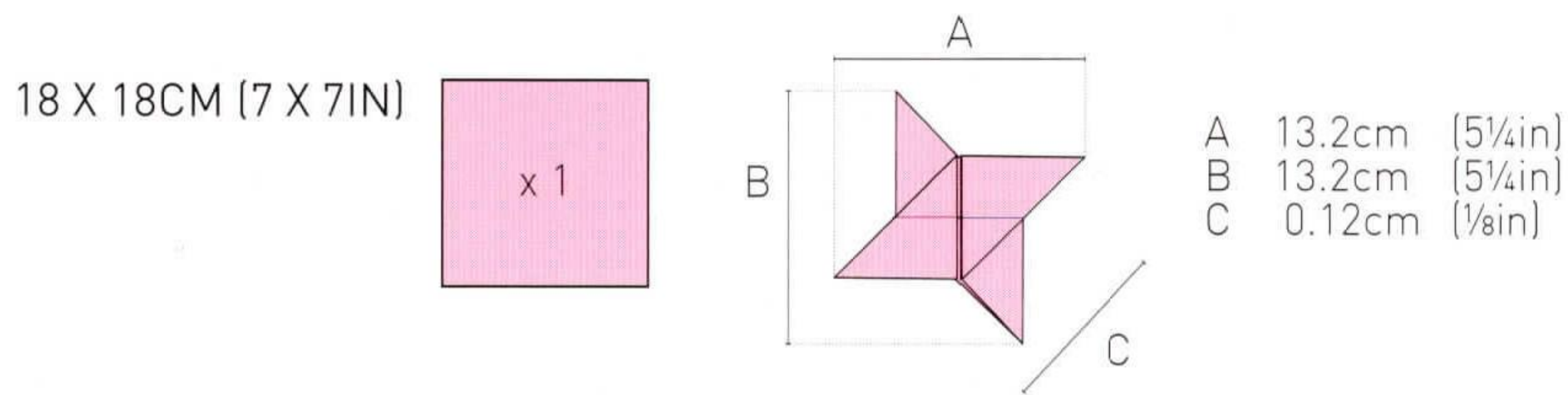

START WITH A SQUARE, COLOURED SIDE UP.

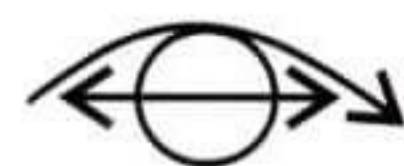
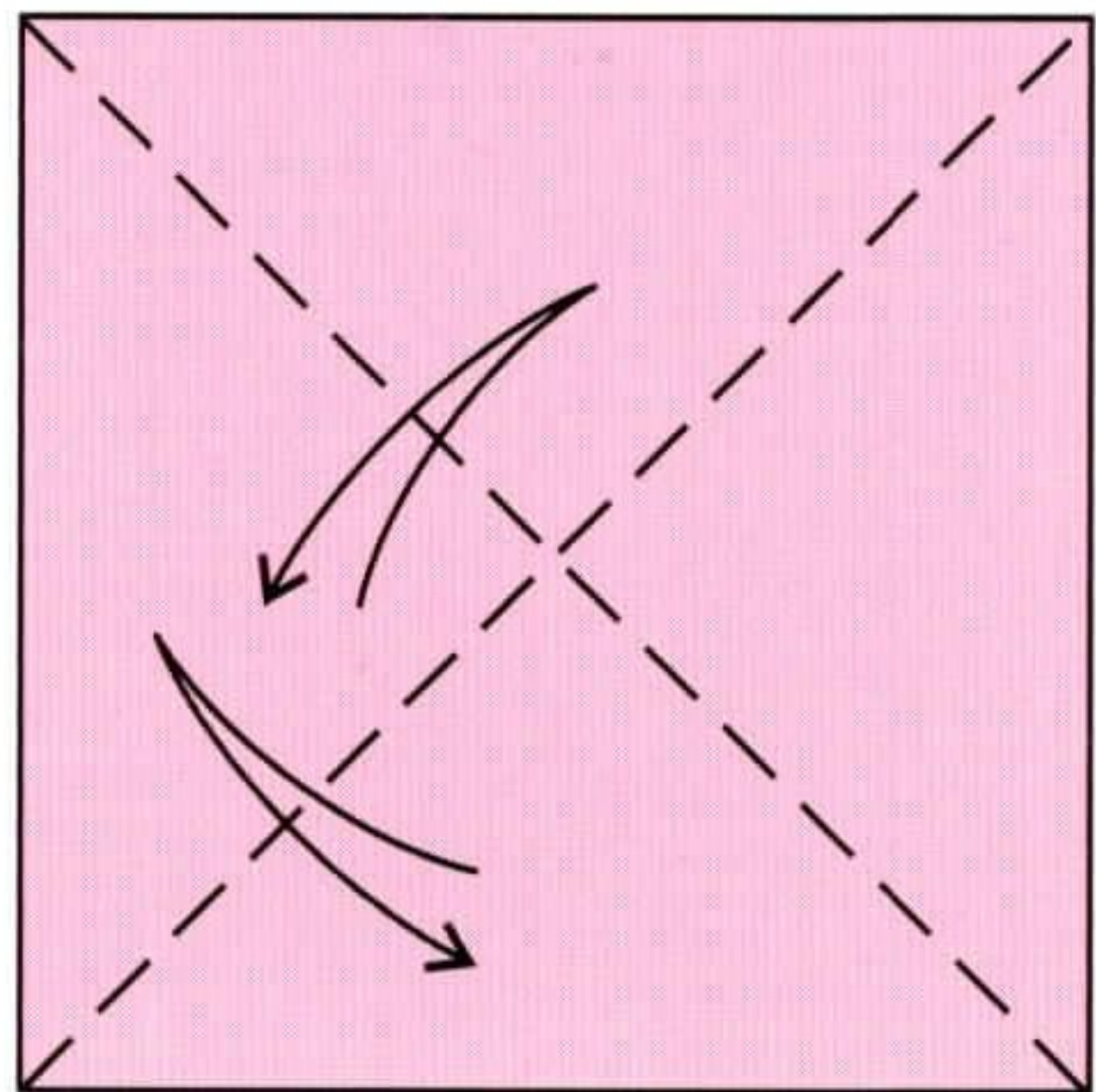

- 1 Fold and unfold the square in half, diagonally. Then turn the paper over left to right.

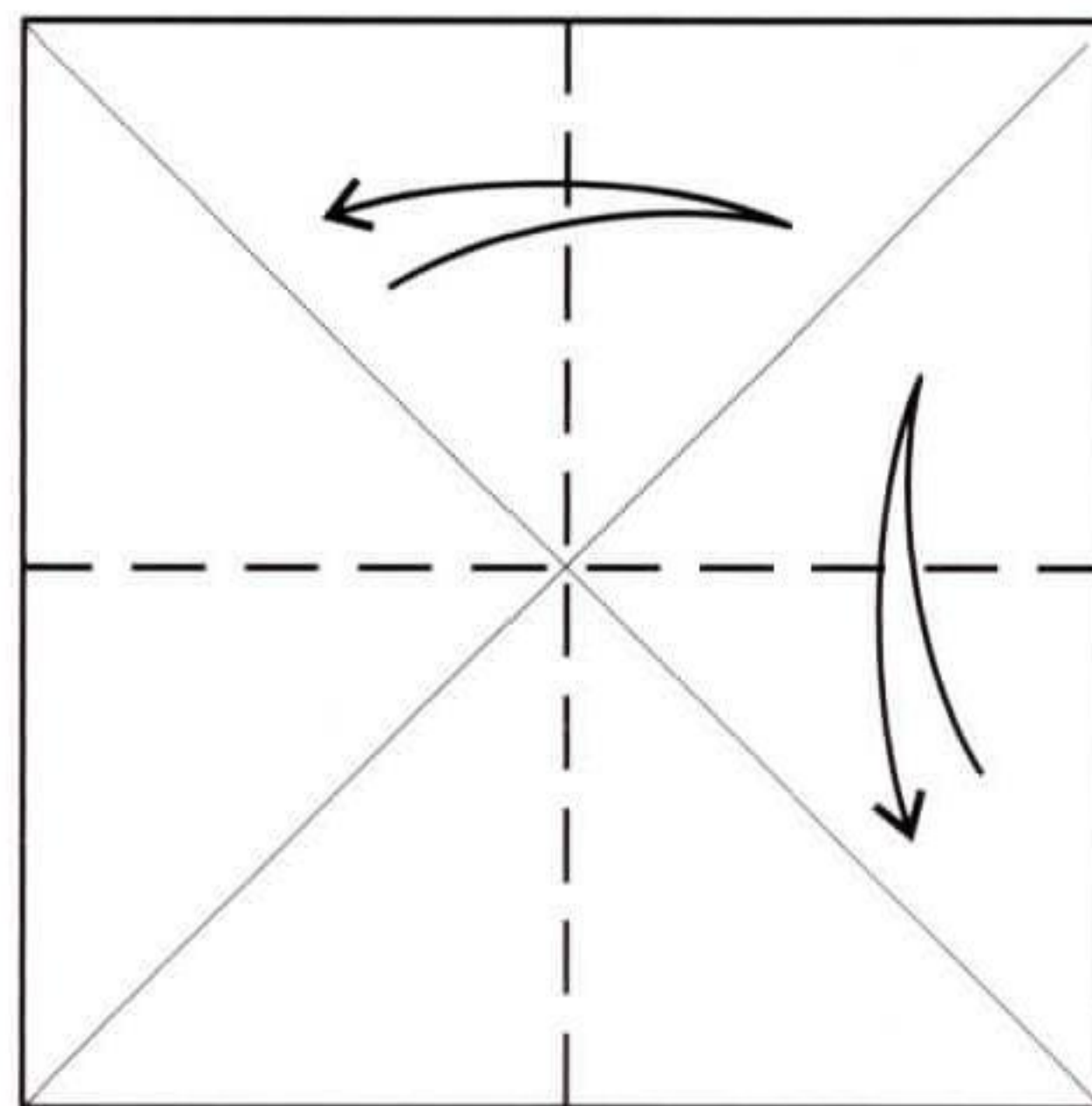

- 2 Fold and unfold the square in half lengthwise along both axes.

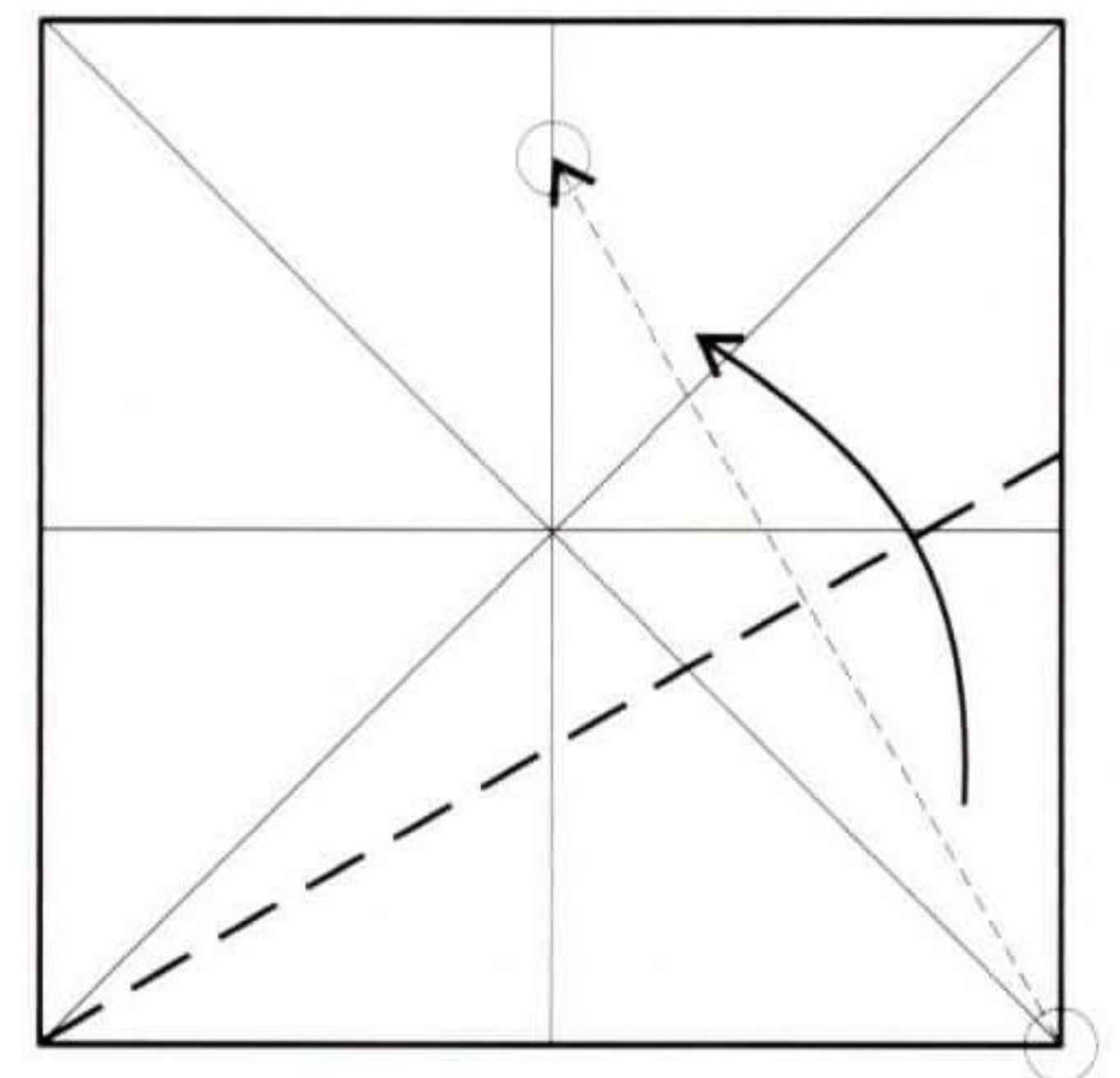

- 3 Fold the lower right corner up to touch the vertical middle crease.



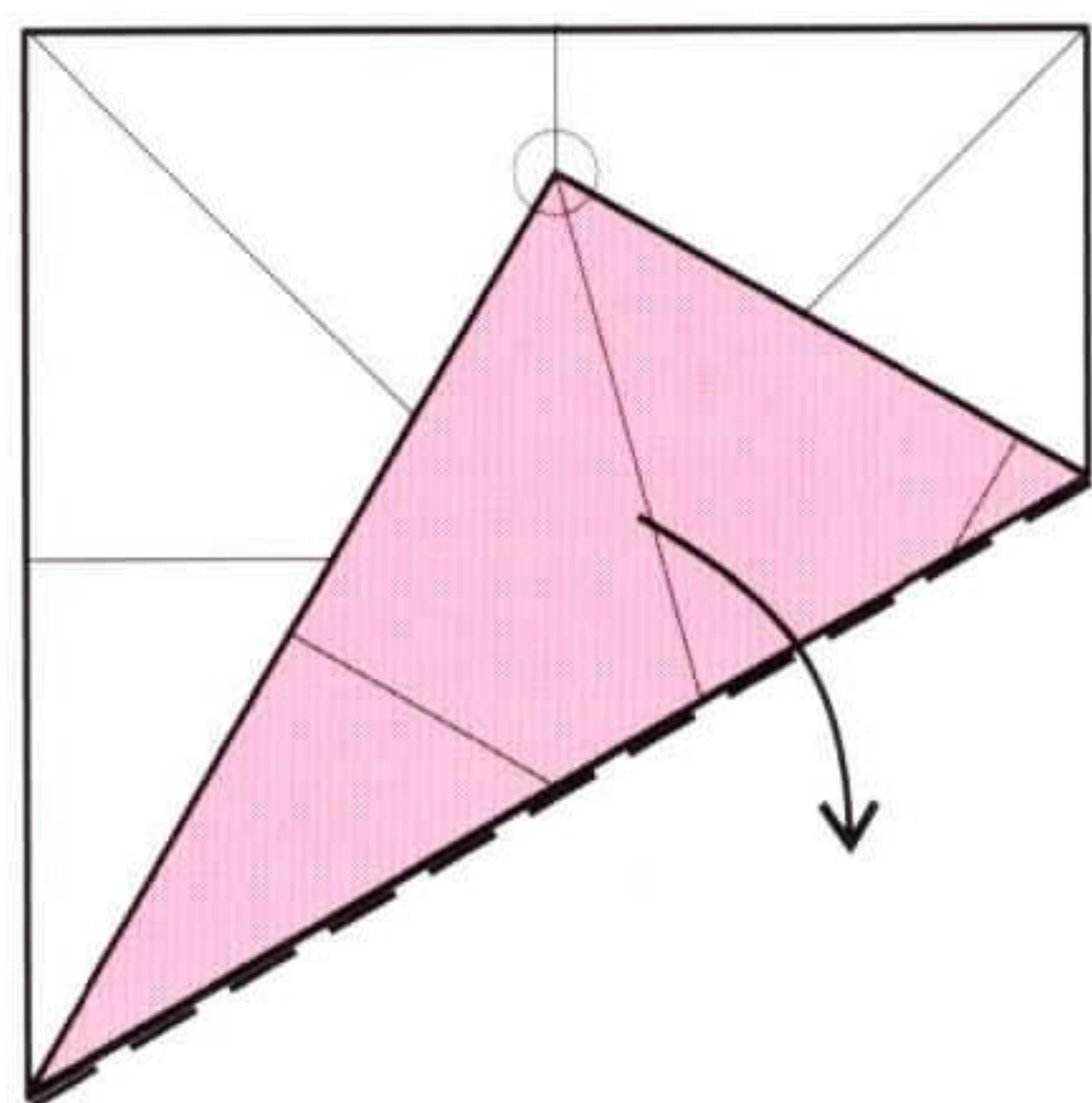

4 Unfold the previous step.

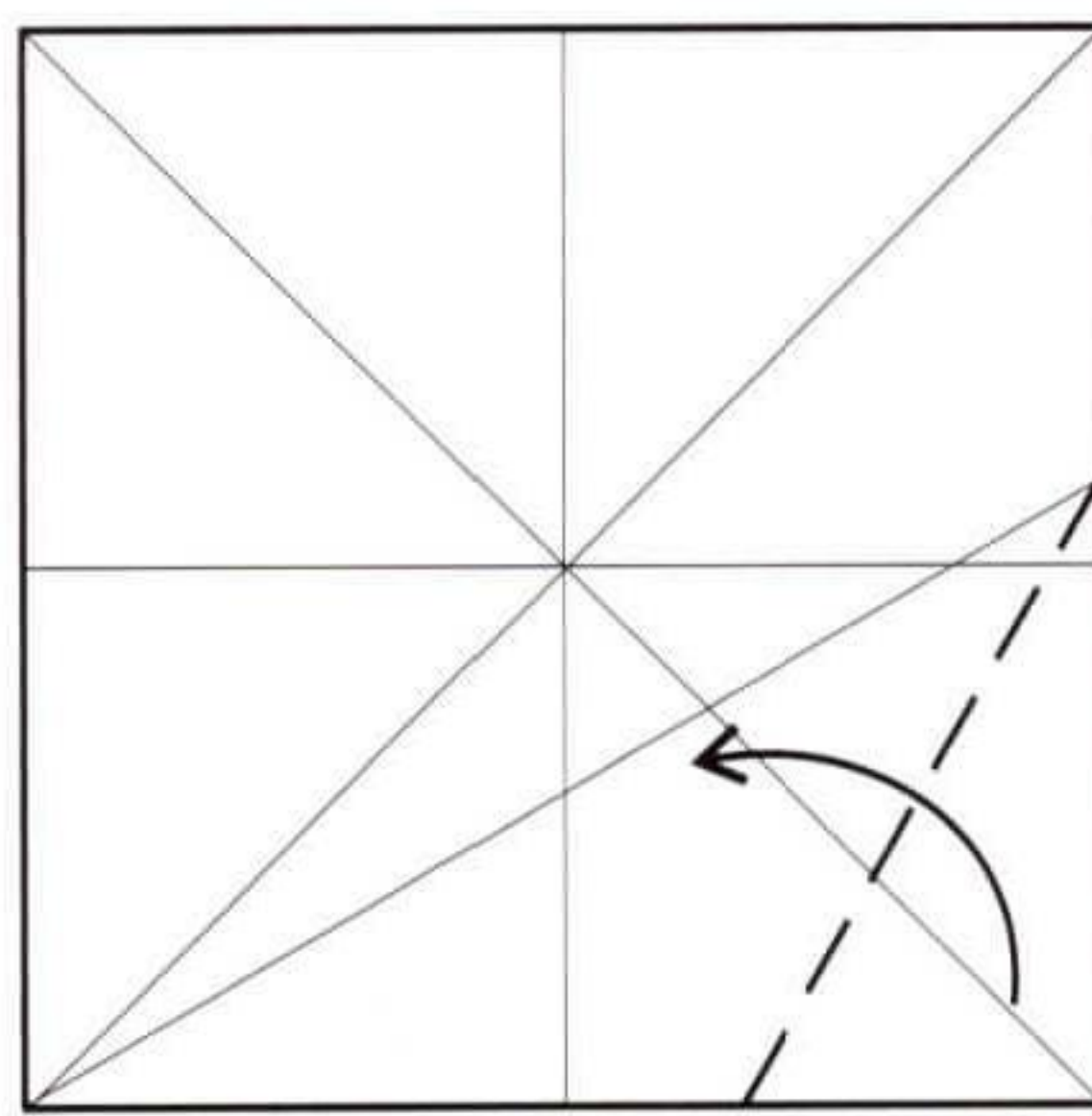

5 Fold lower corner in to touch the crease made previously.

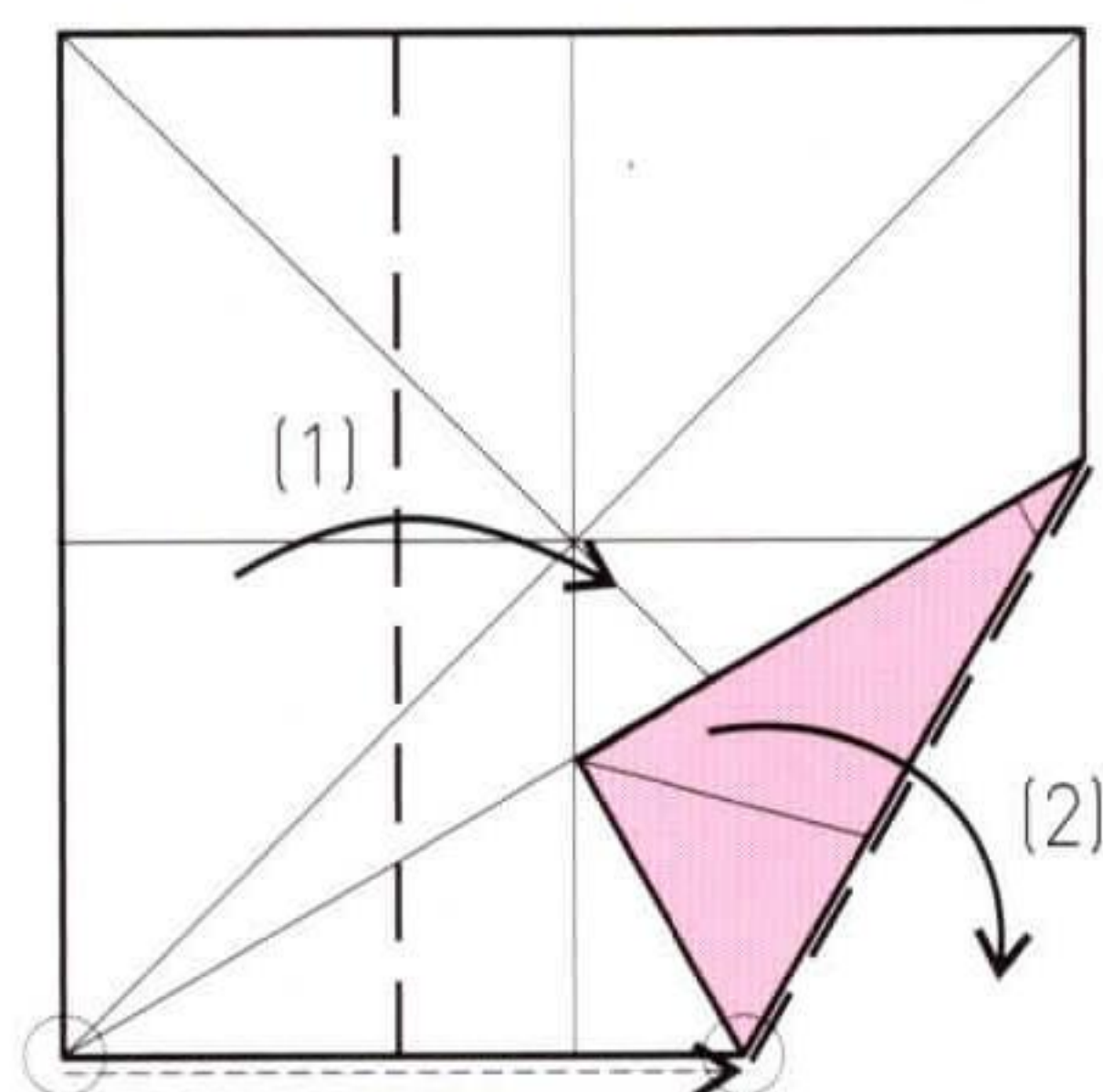

6 (1) Fold the left side in. Then (2) unfold the corner folded in the previous step.

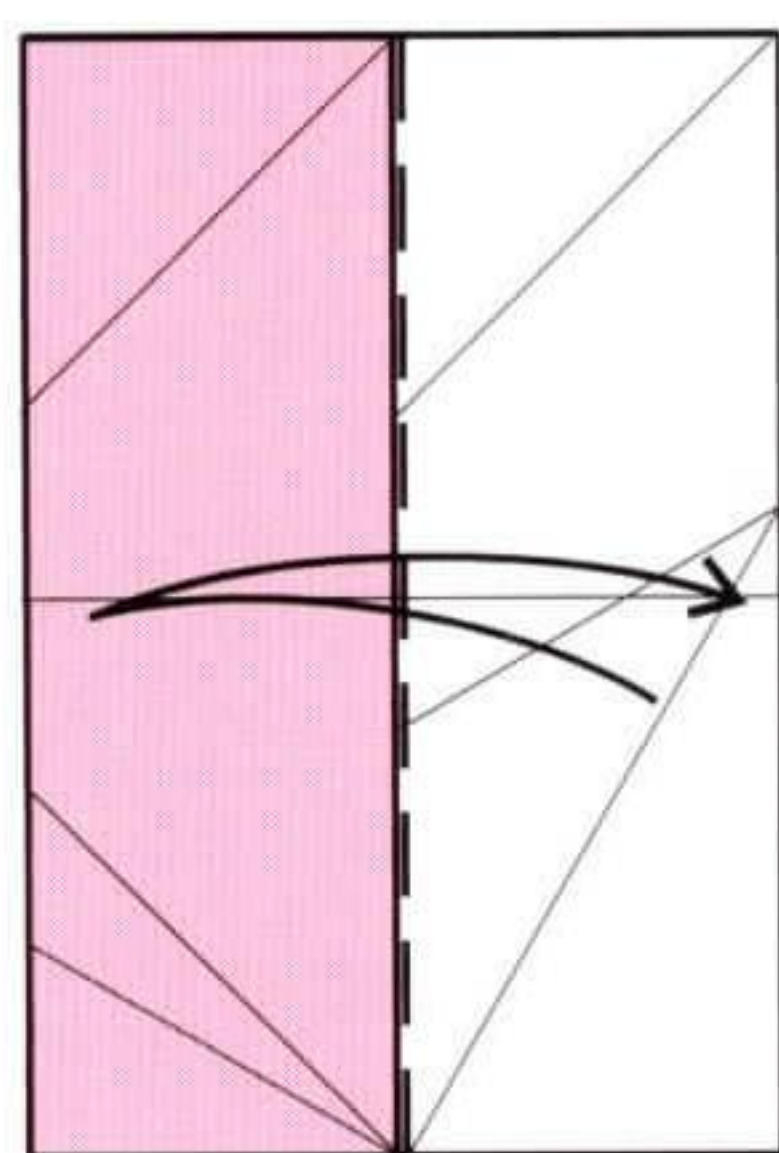

7 Fold the right side in and then out again.

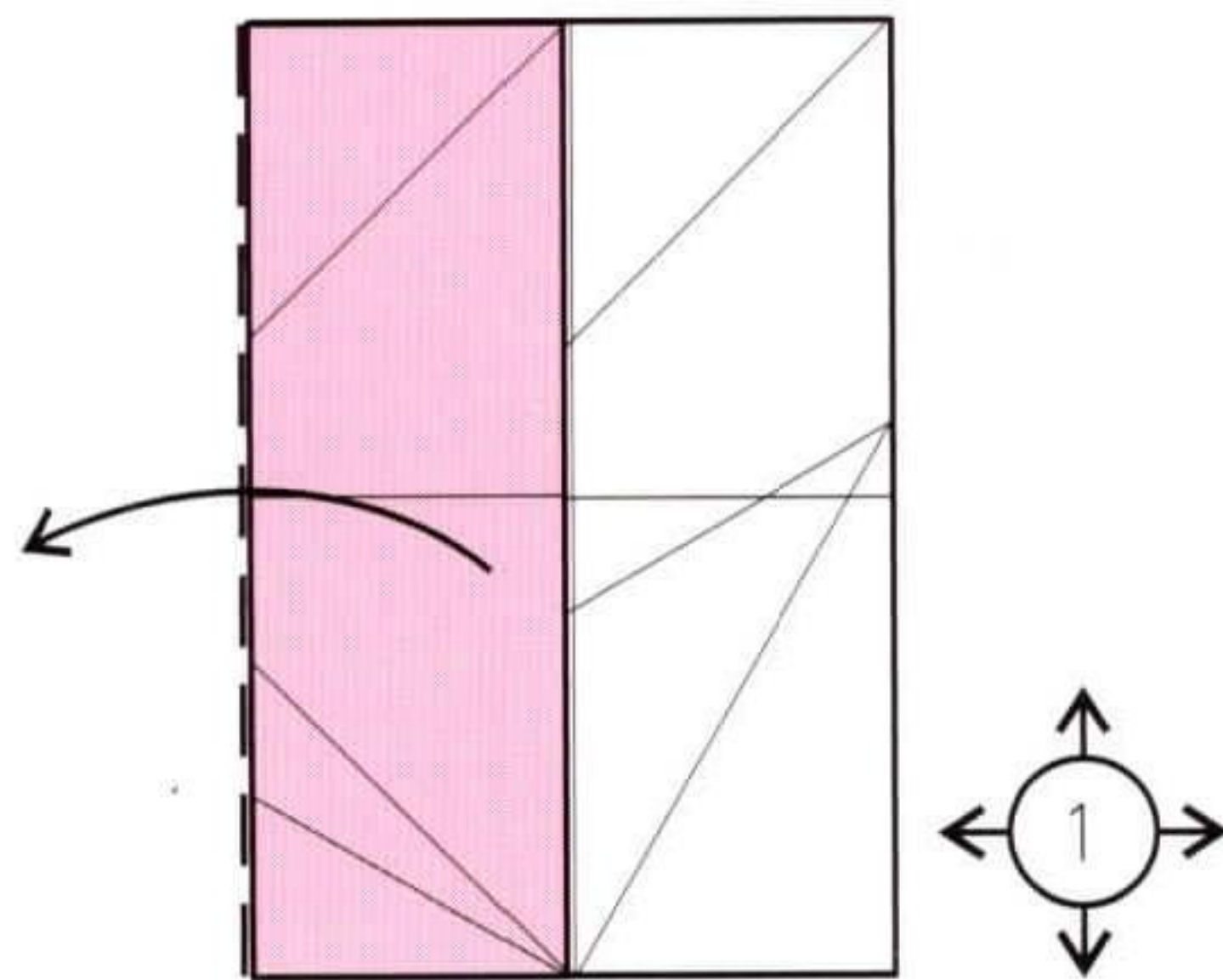

8 Unfold back to a square.

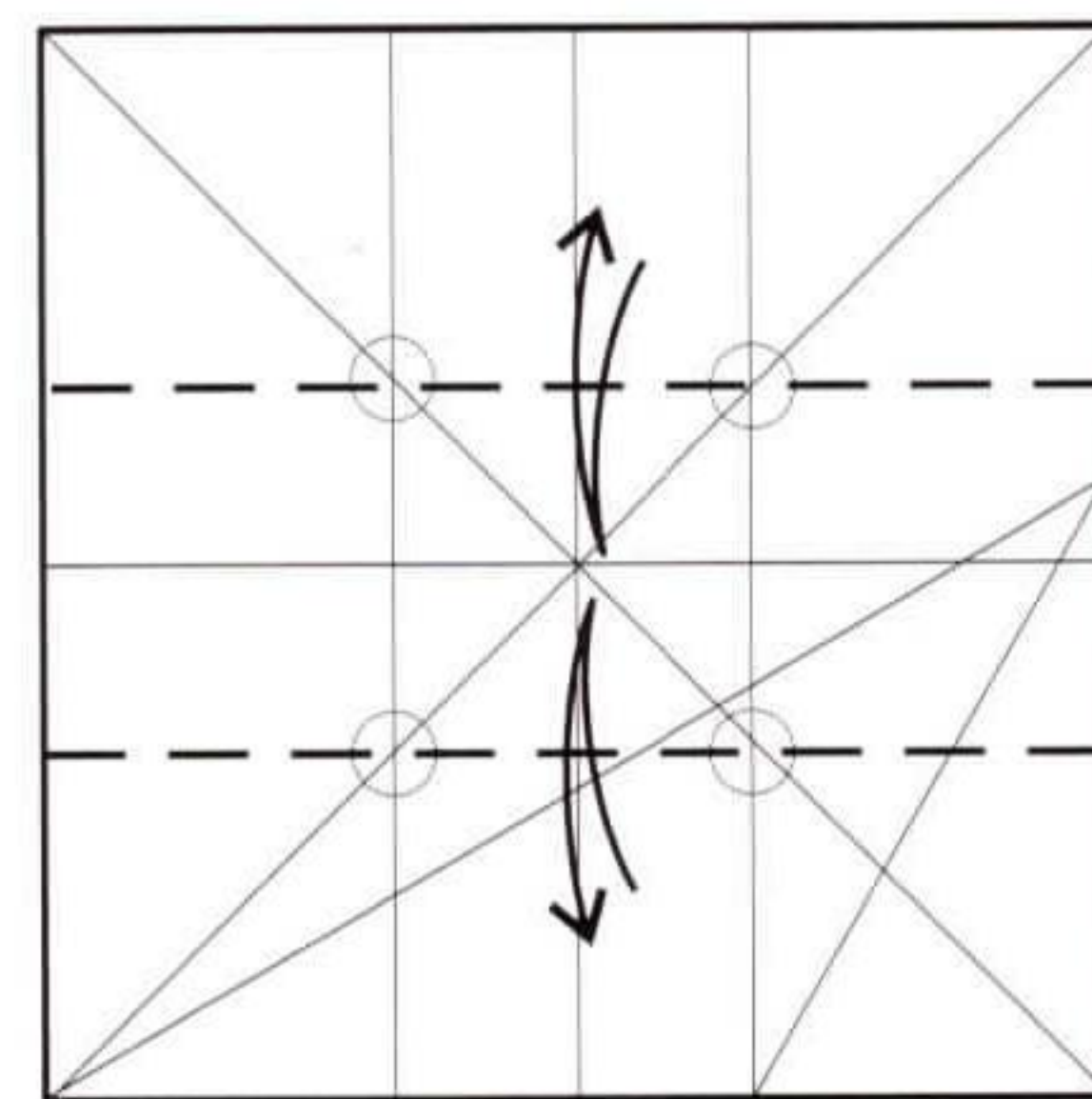

9 Fold the upper and lower edges in where the vertical creases touch the diagonal creases, to divide into thirds.

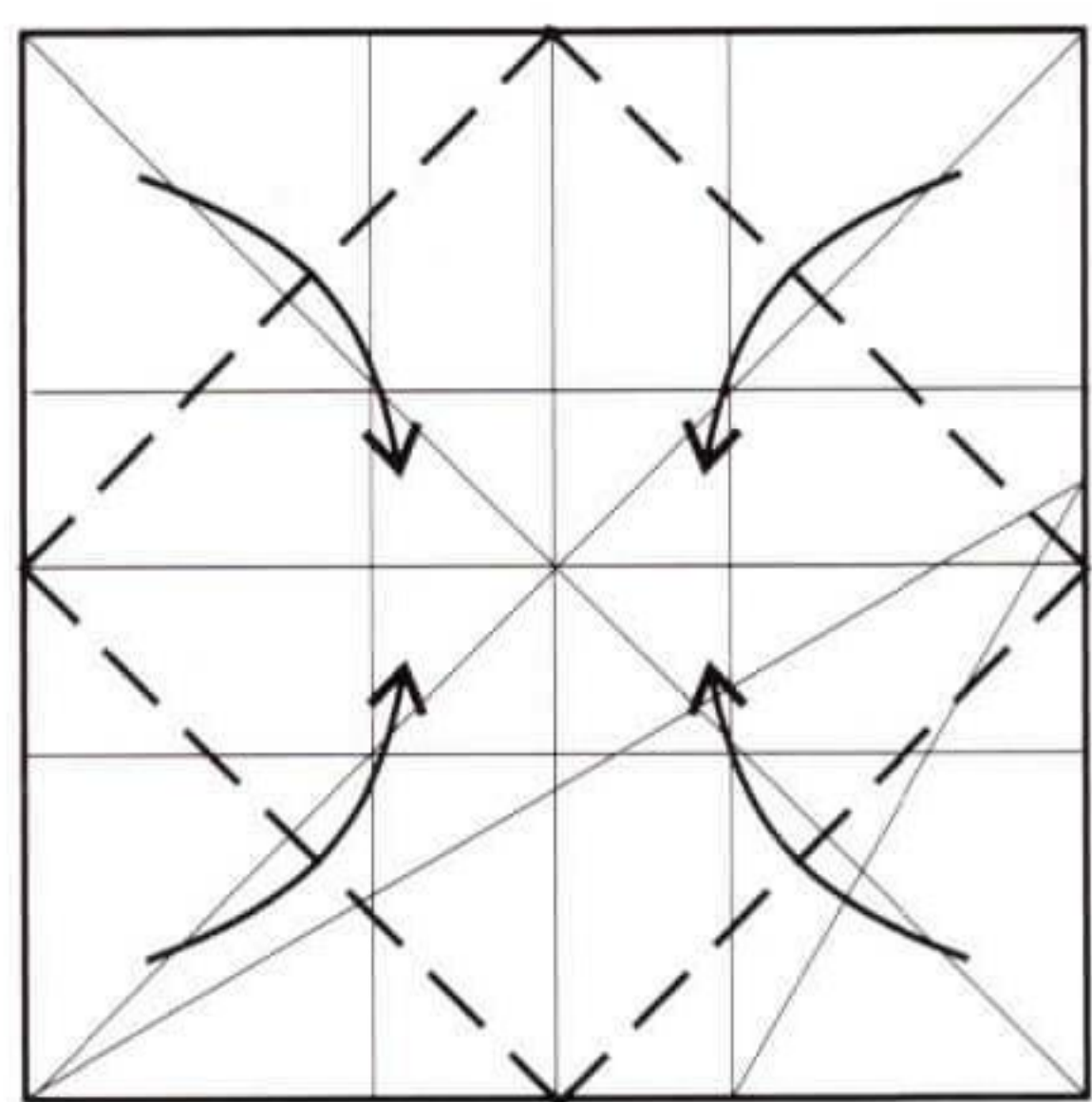

10 Fold the corners in to the middle of the paper.

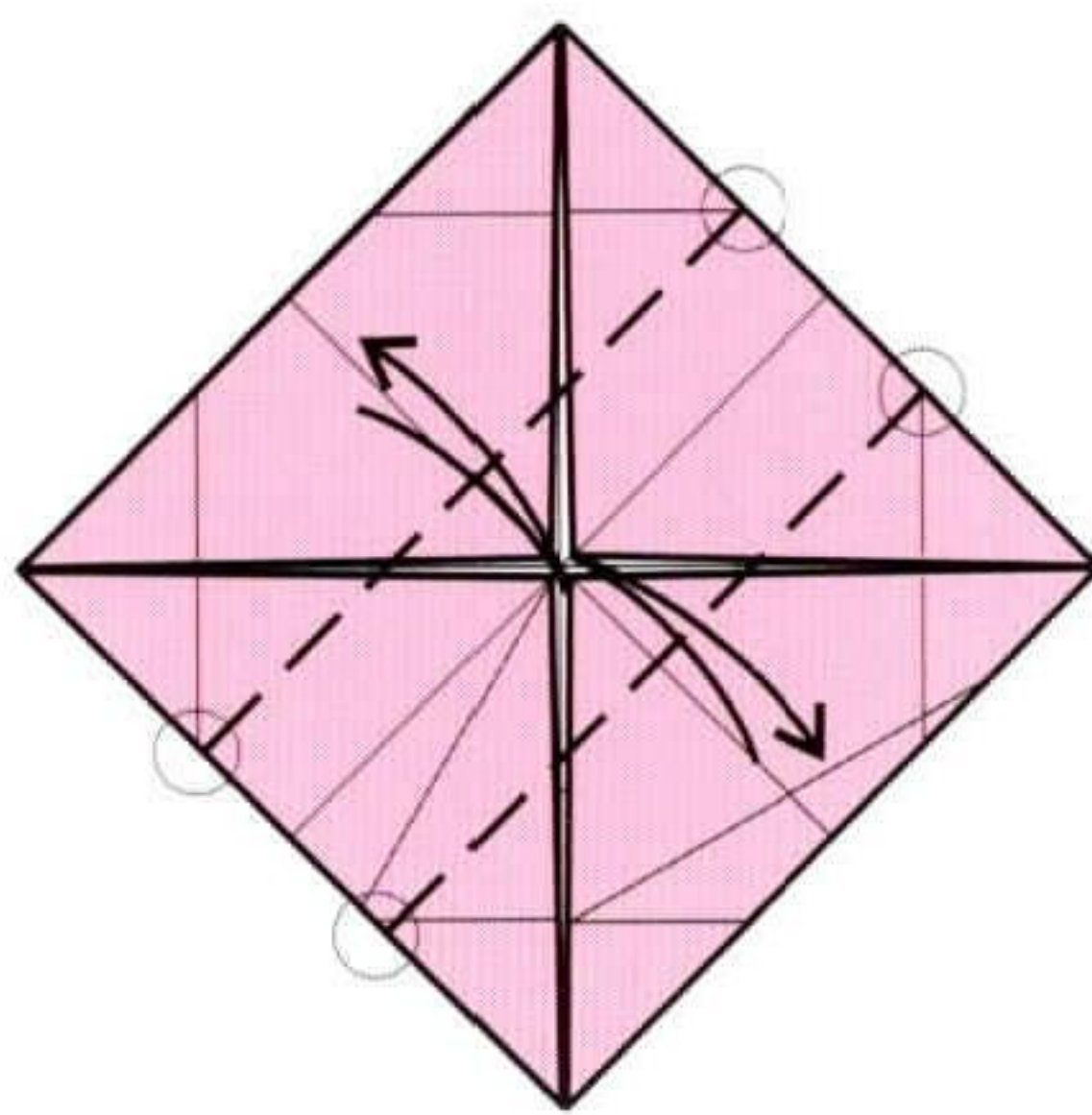

11 Fold the outer edges in at the points where the diagonal creases touch the edges, dividing the model into thirds. Then unfold.

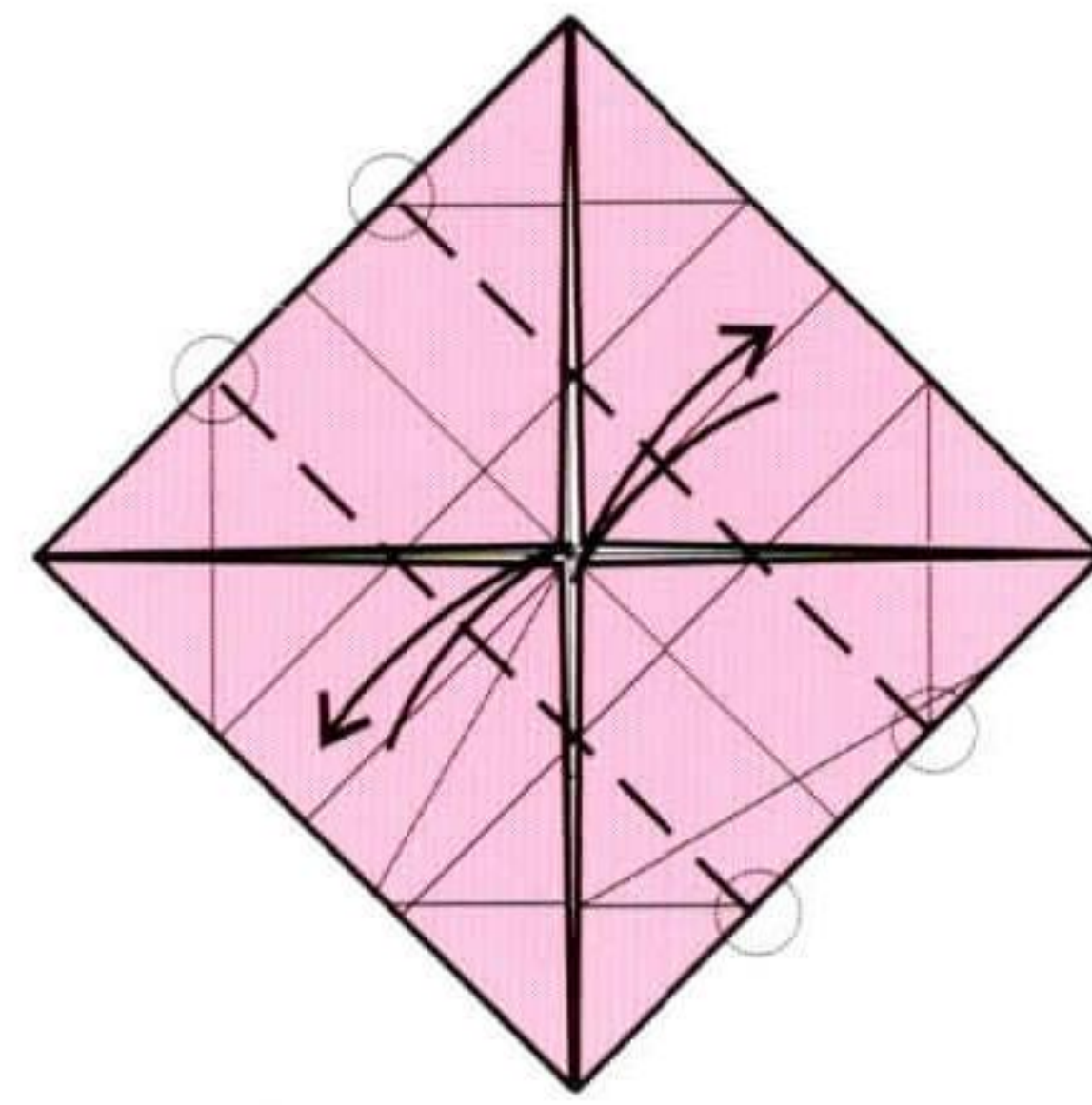

12 Repeat step 11 on the other axis.

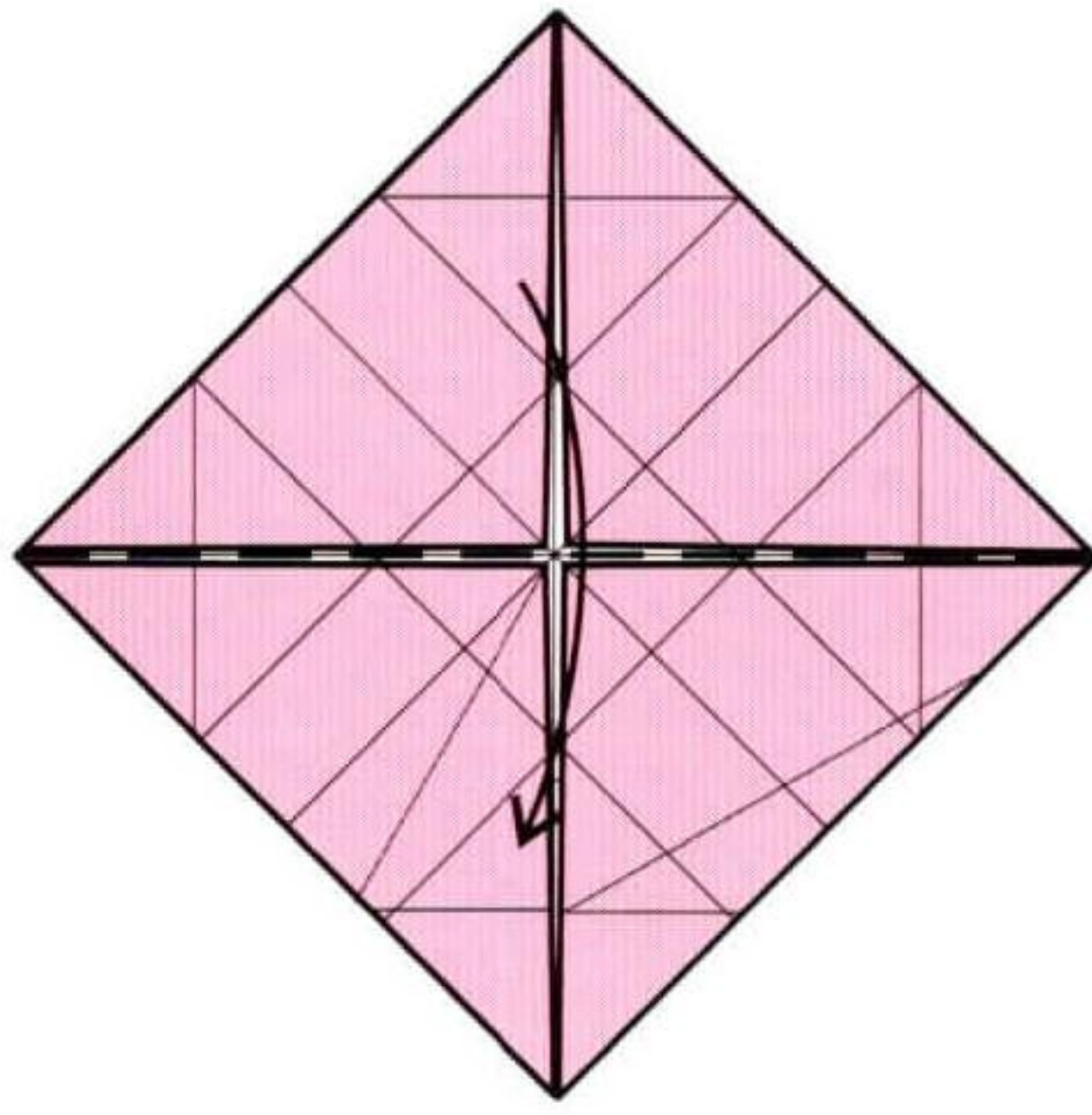

13 Fold the model in half.

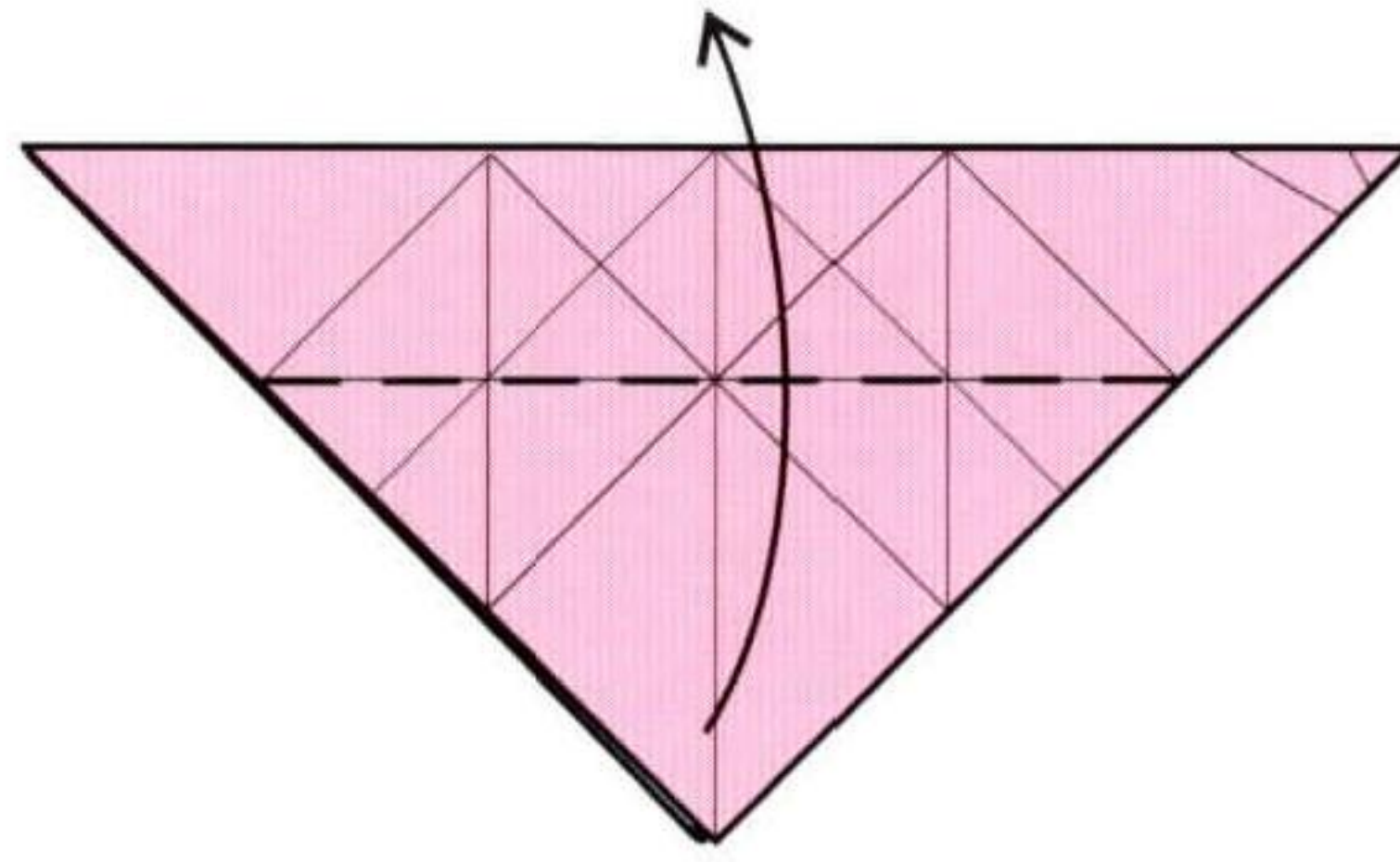

14 Fold the upper layer up between the points where the diagonal creases touch the folded edge.

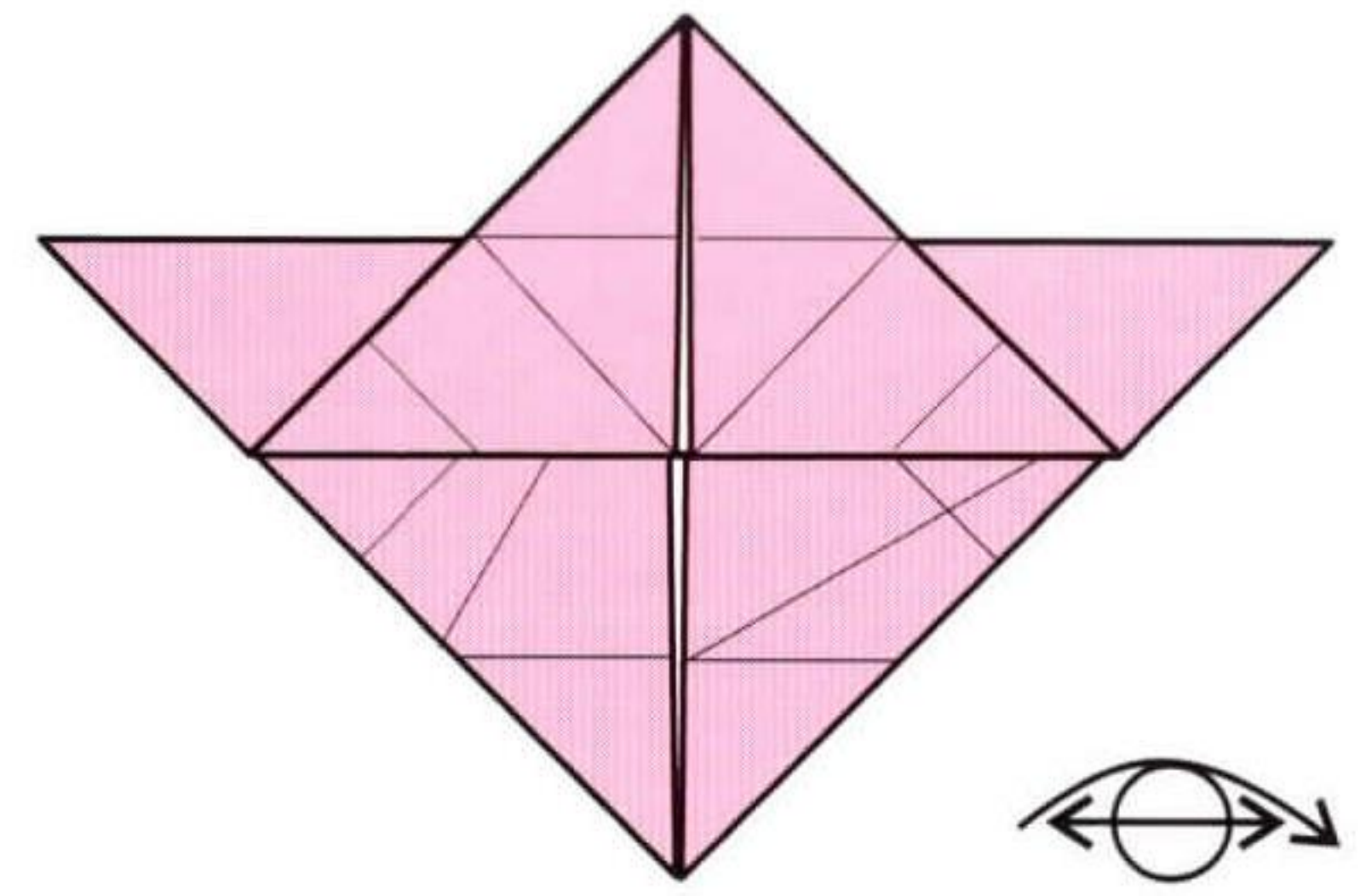

15 Turn the model over left to right.

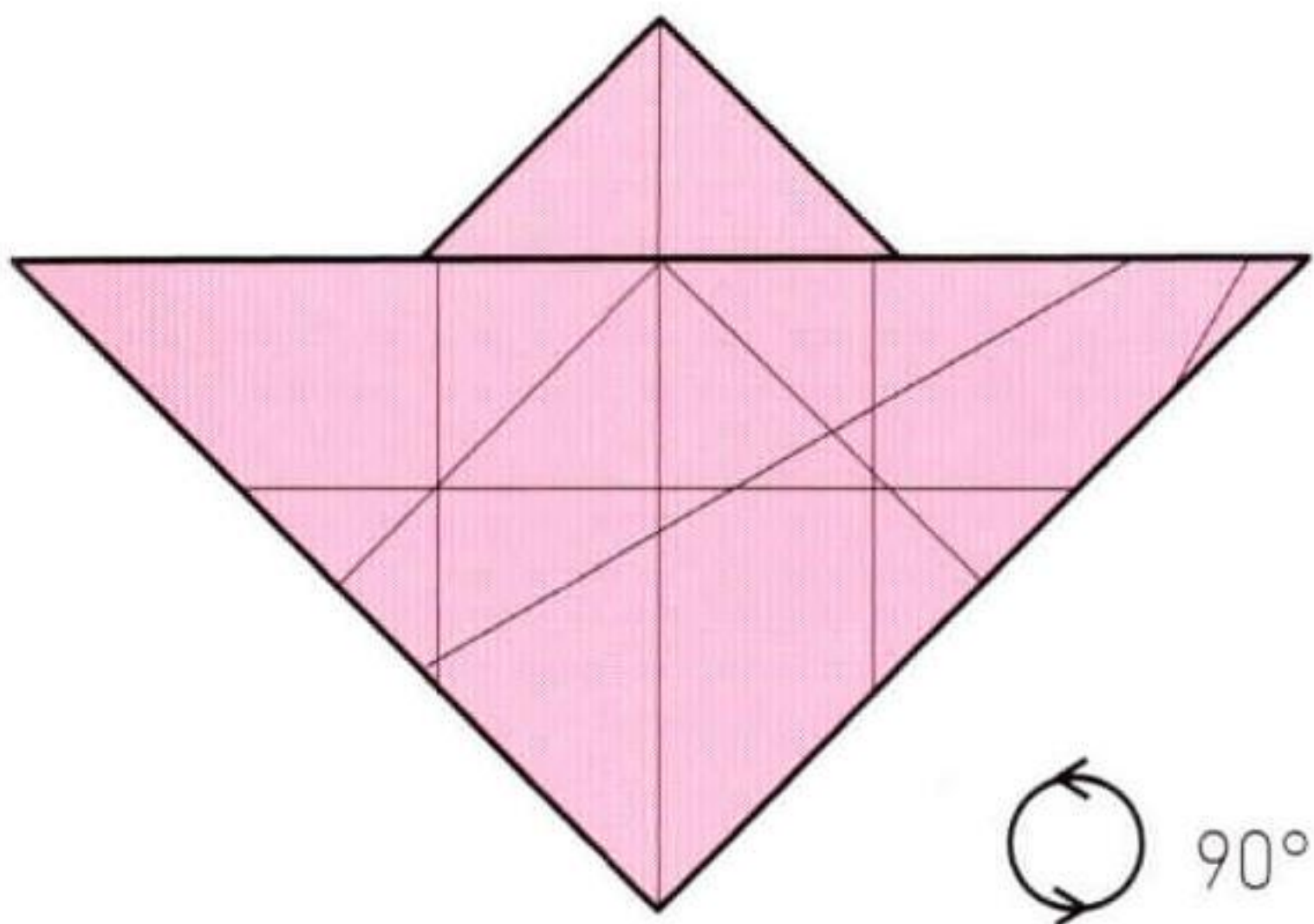

16 Rotate the model anticlockwise by 90°.

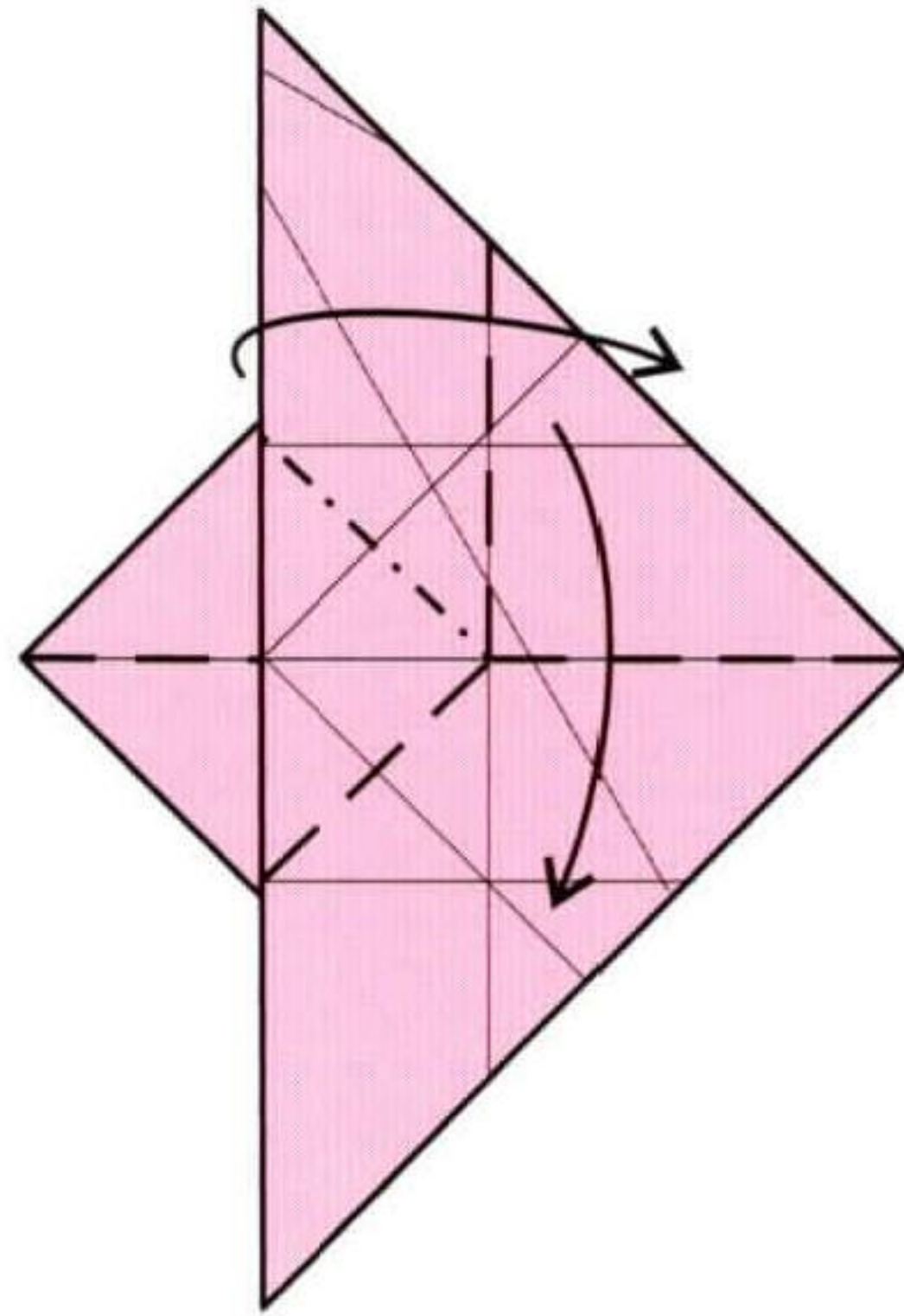

17 Fold the upper section down. At the same time fold the upper layer of the top section to the right. Hold the lower left edge in place.

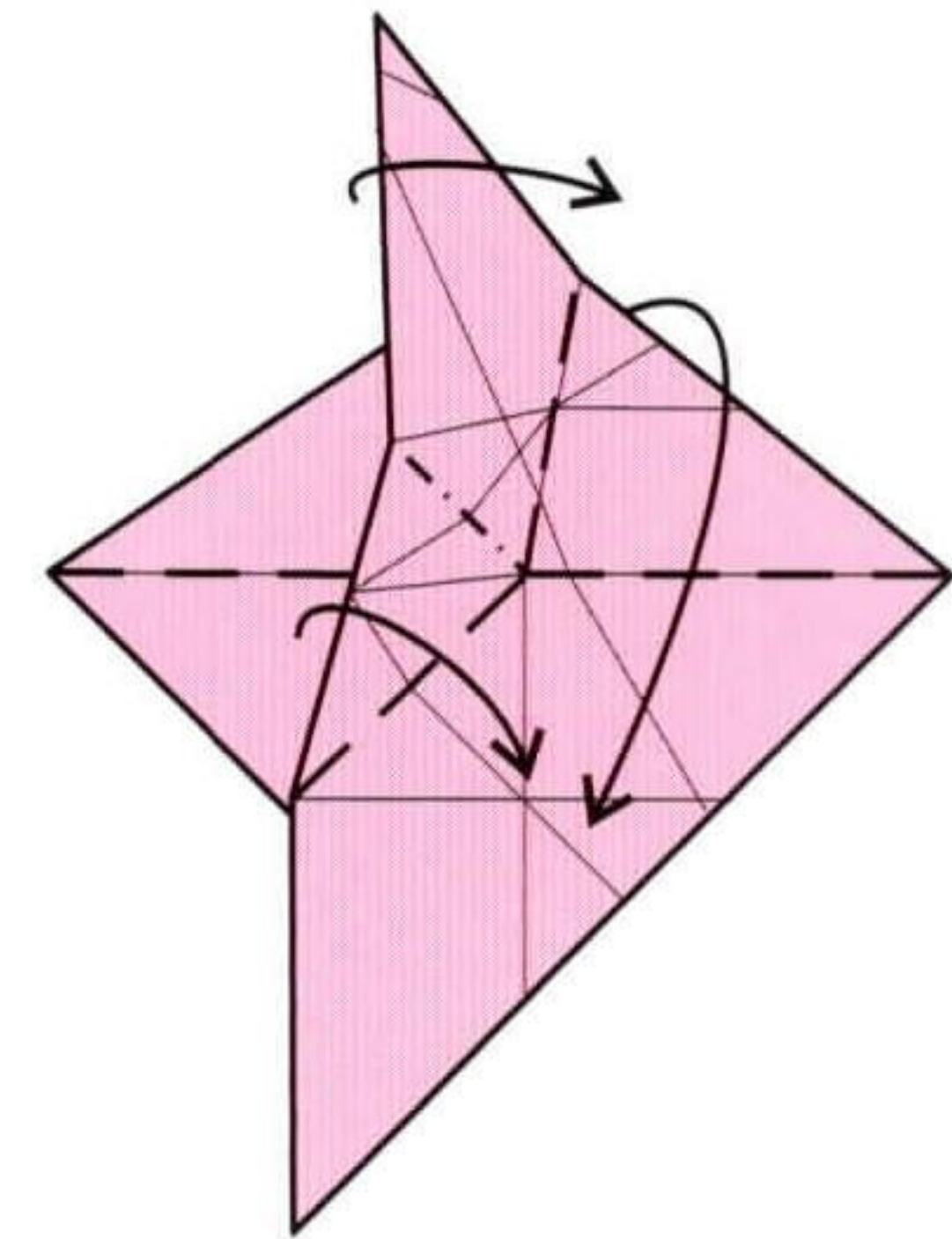

18 Fold in progress.

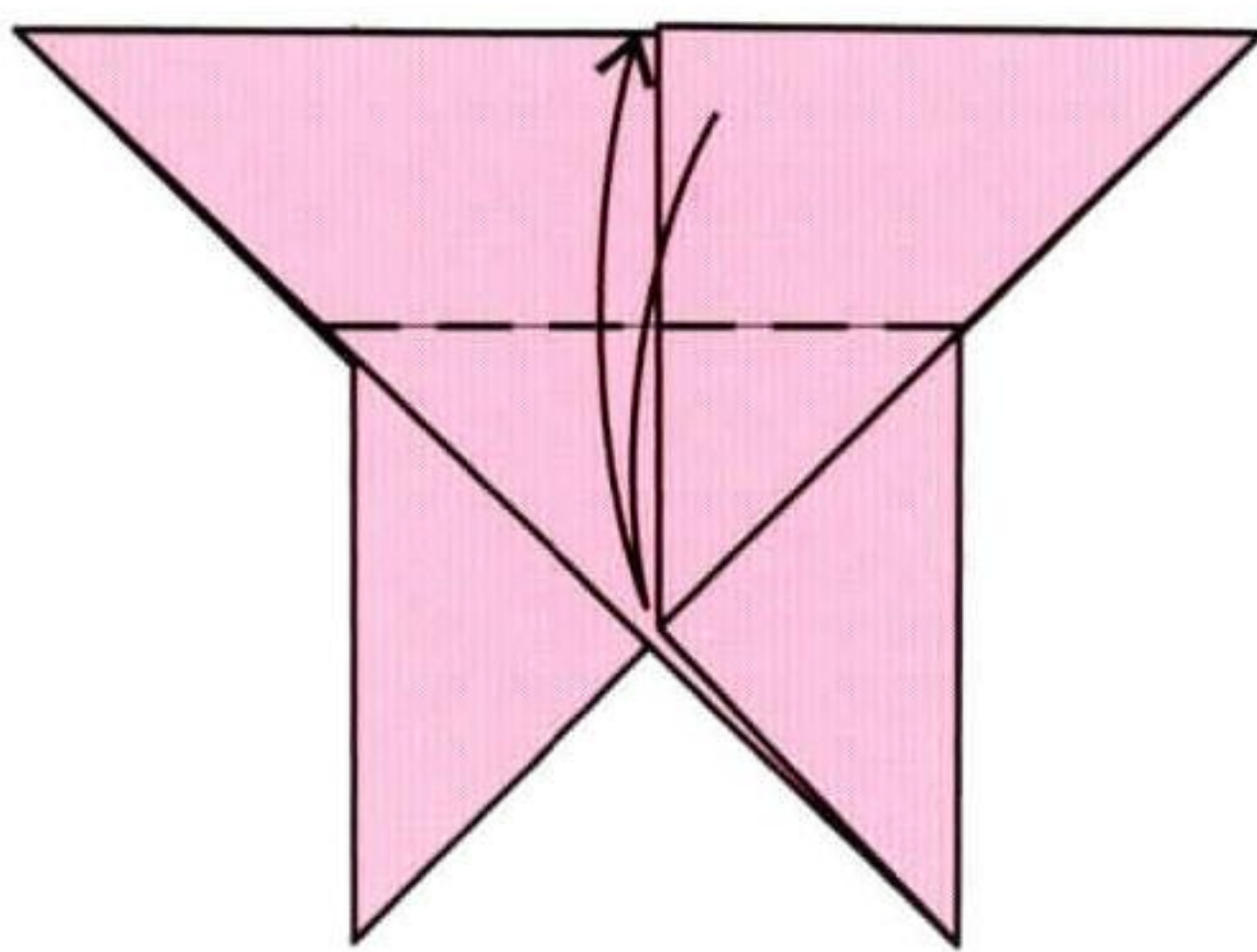

19 Fold the lower section up and down again.

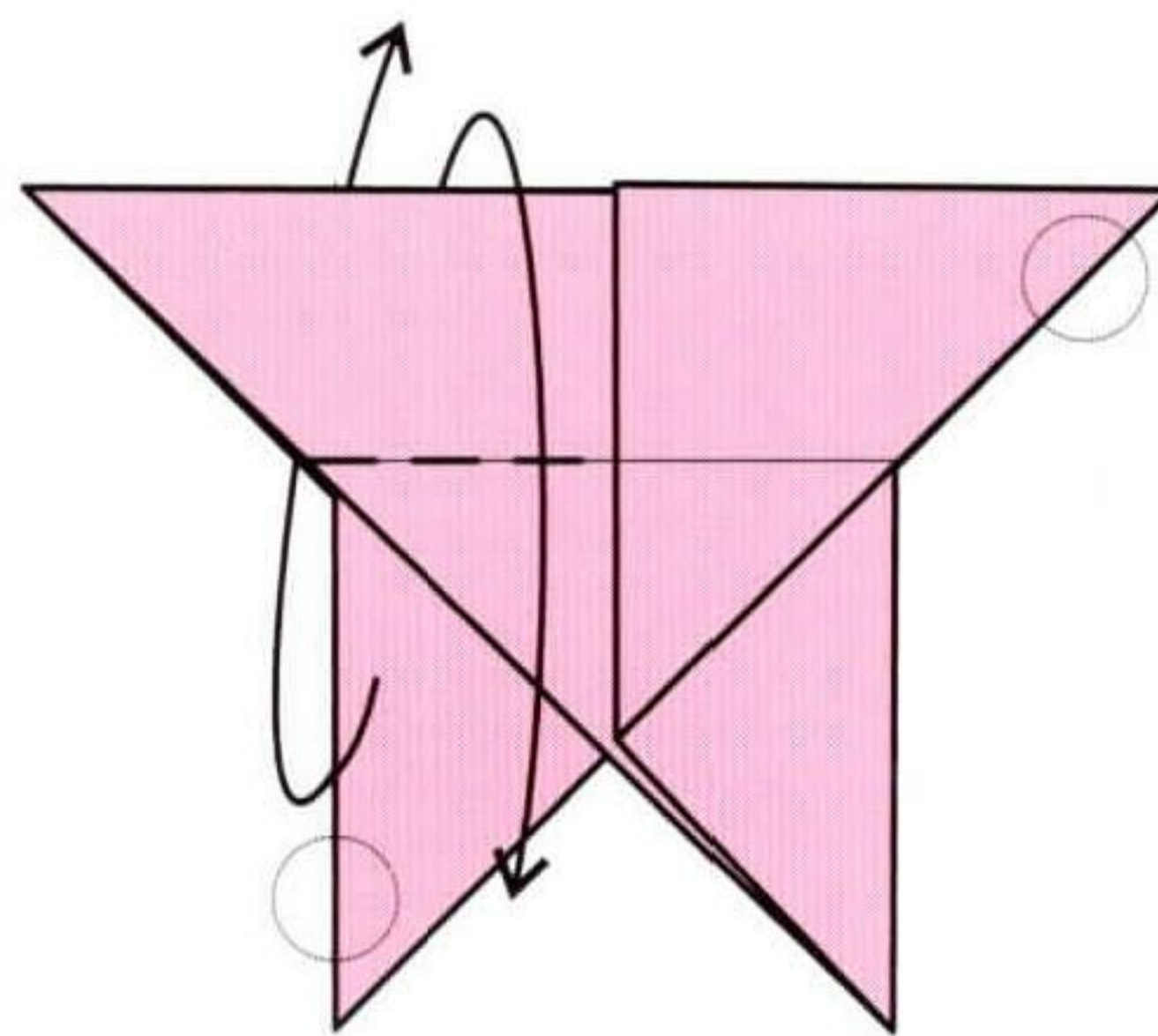

20 Fold the upper left edge down while holding the right side still. This will cause a twist fold.

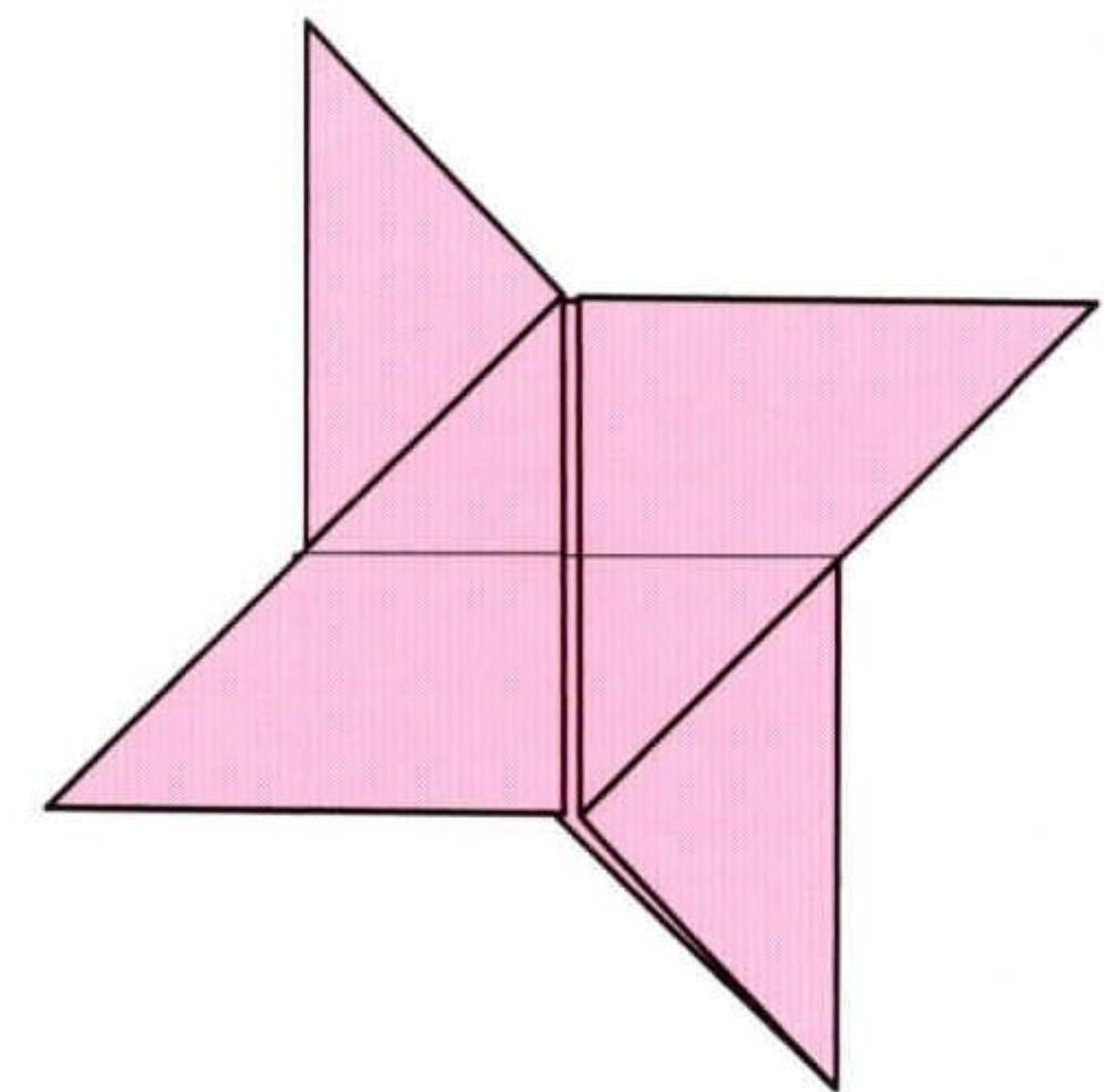

21 Complete.

Diamond Wreath

**

The diamond is made by applying the twist fold process to a diagonally folded square. The final diamond model has both points and pockets and can be used as a module to create larger constructions.

18 X 18CM (7 X 7IN)

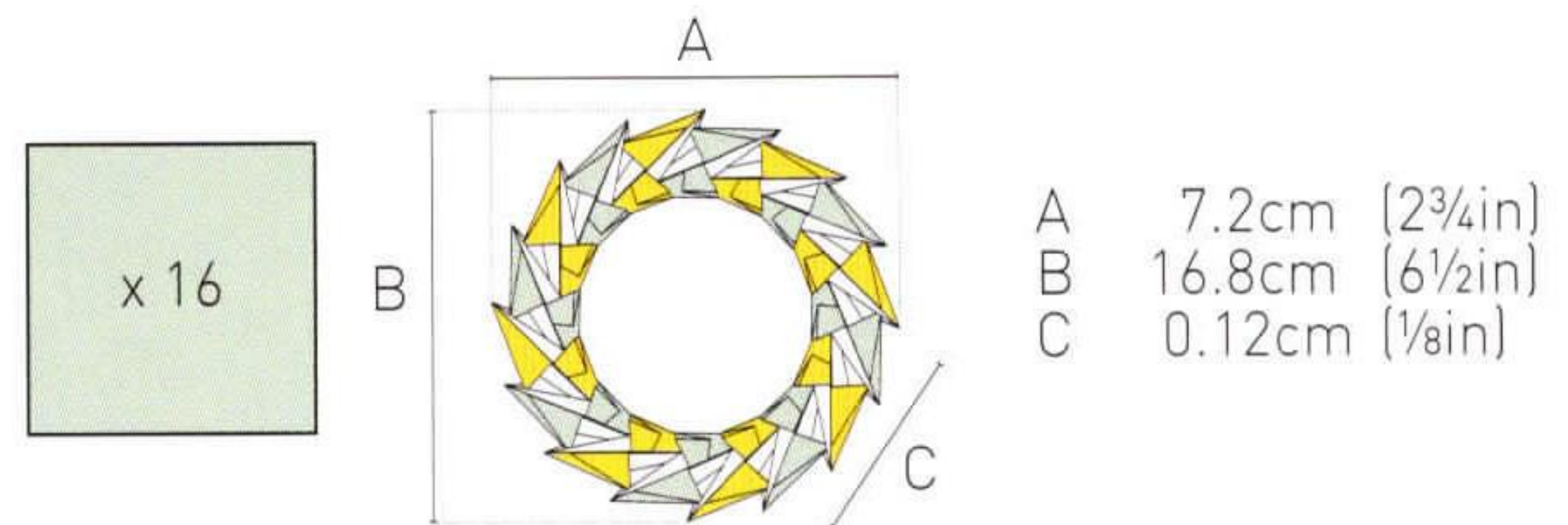
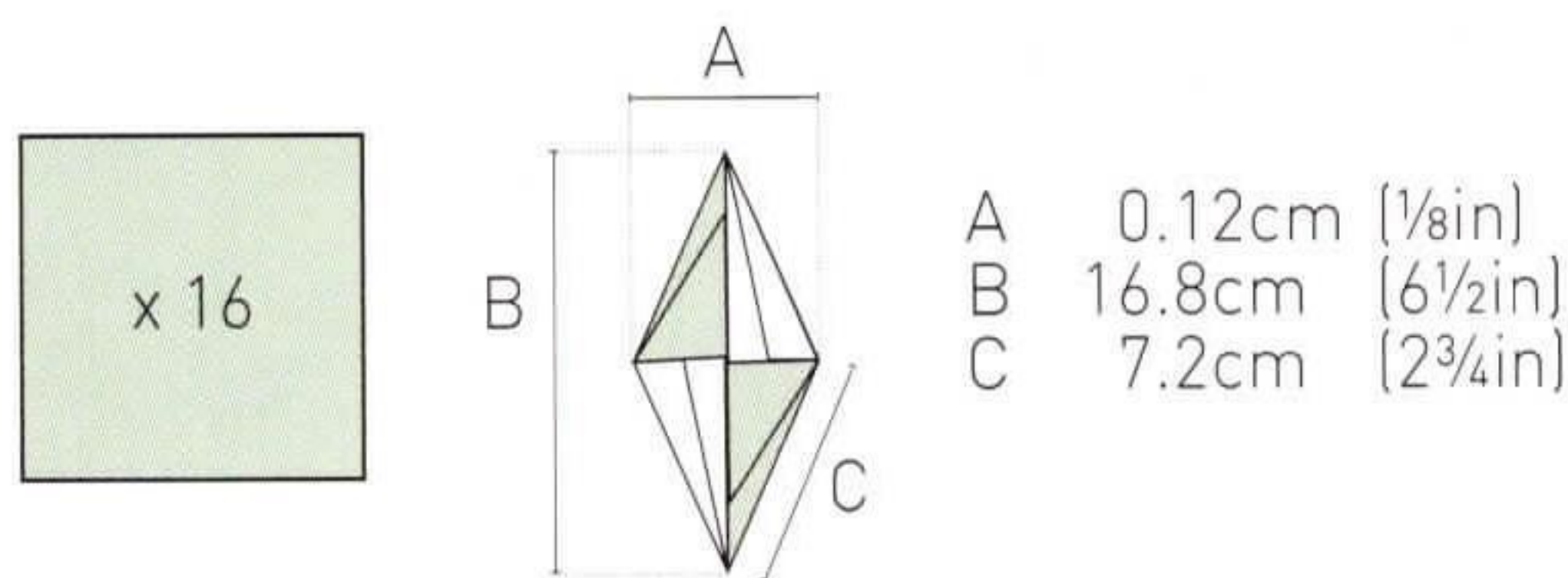

START EACH OF THE 16 DIAMONDS WITH A SQUARE, COLOURED SIDE UP.

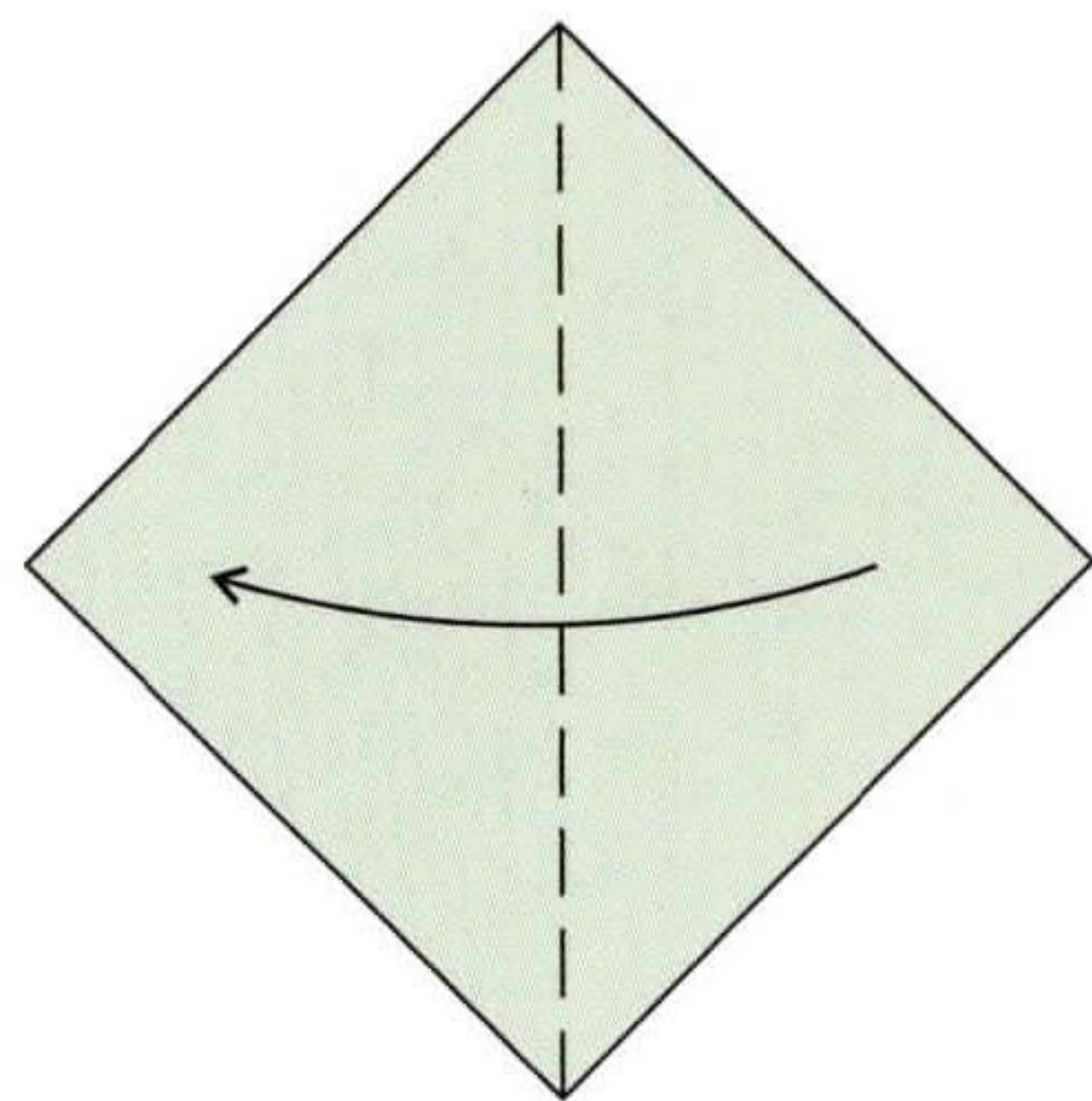

- 1 Fold the square in half diagonally.

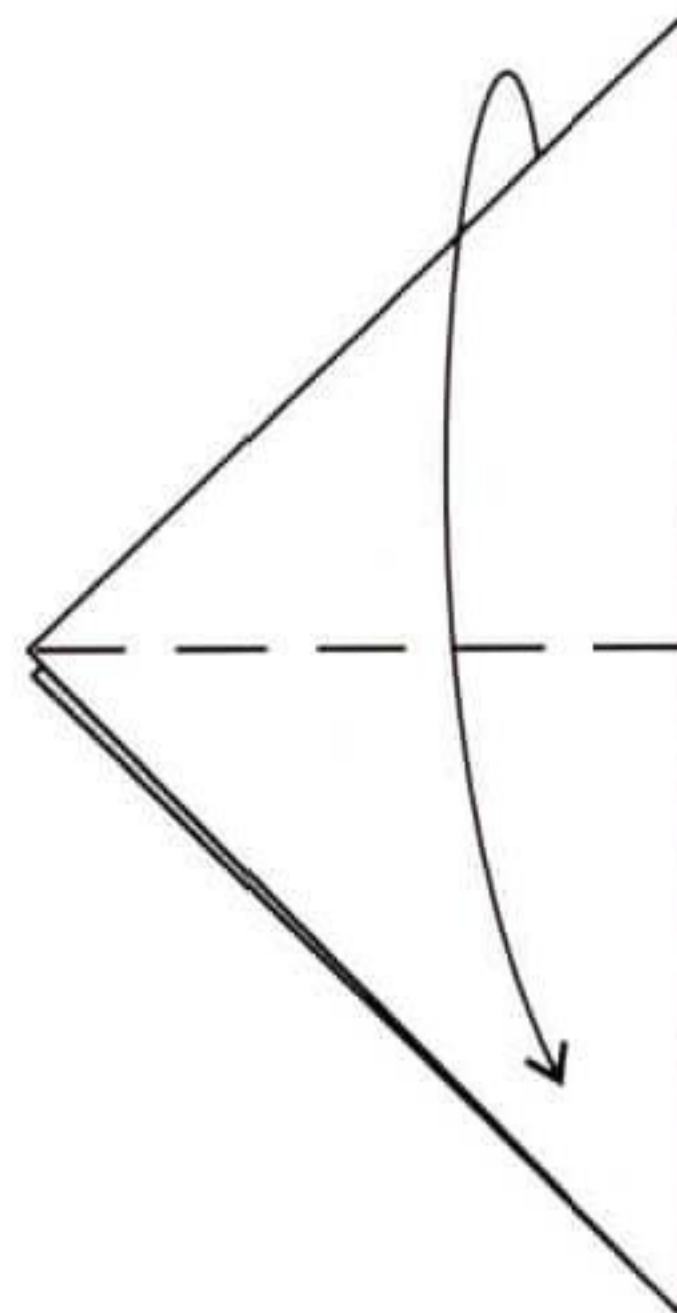

- 2 Fold the model in half again.

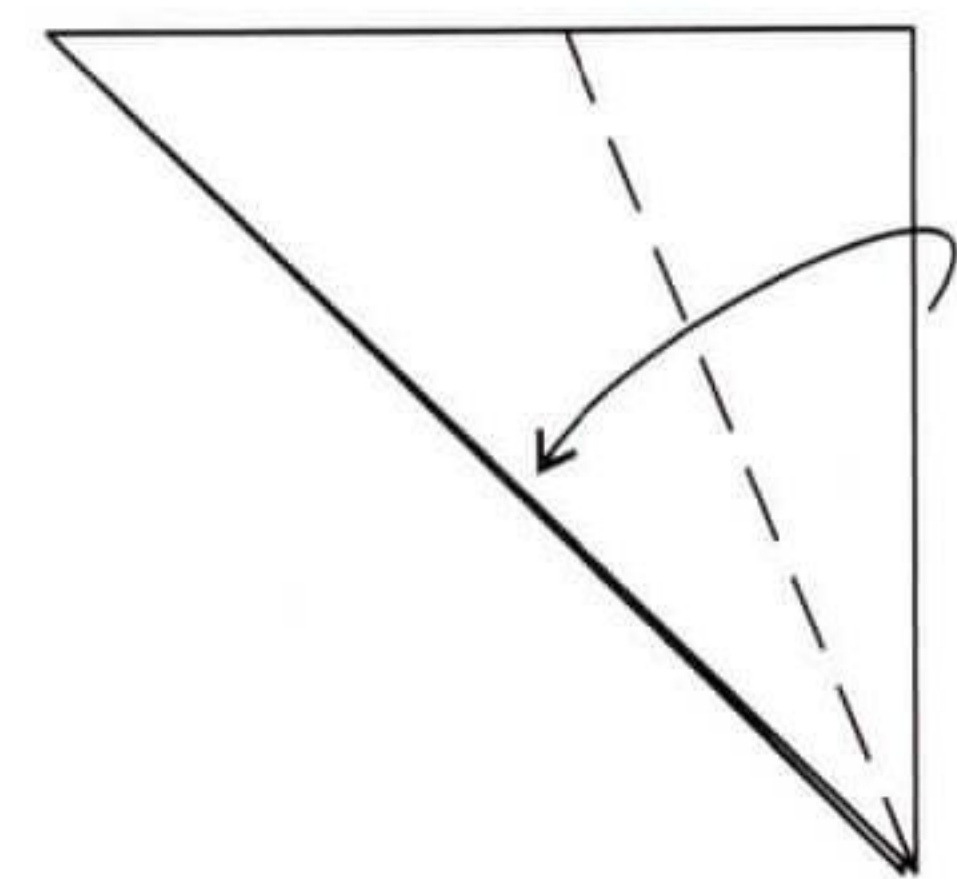

- 3 Fold the right edge in diagonally to touch the opposite edge.

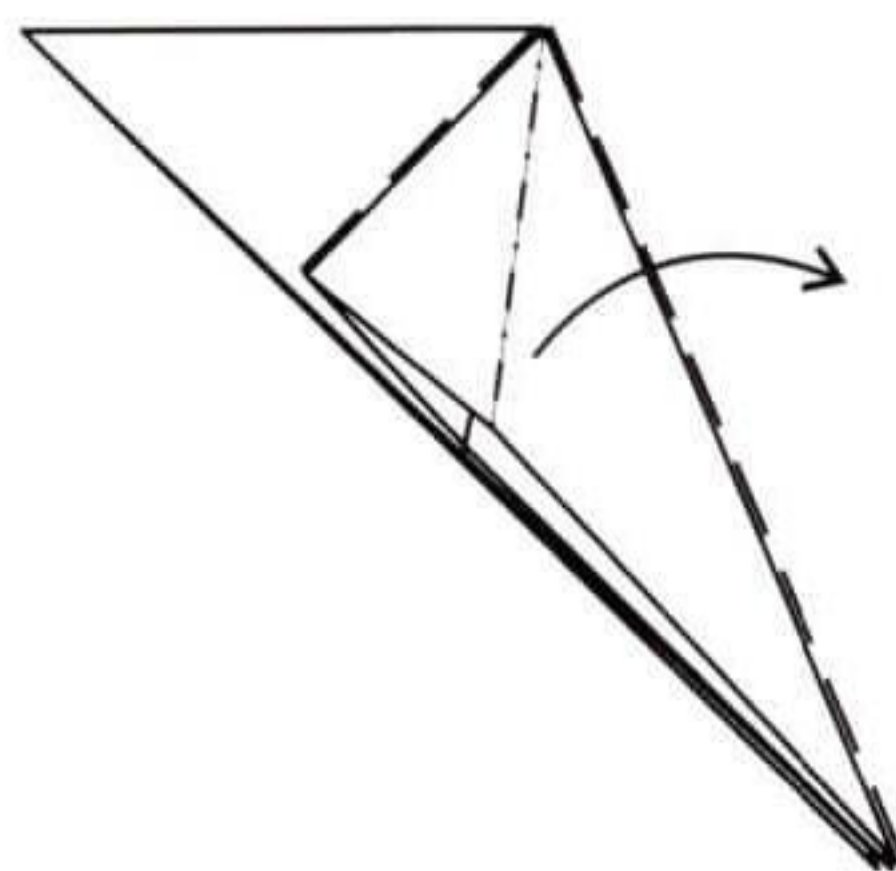

- 4 Fold the upper section up, separate the layers and squash it flat.

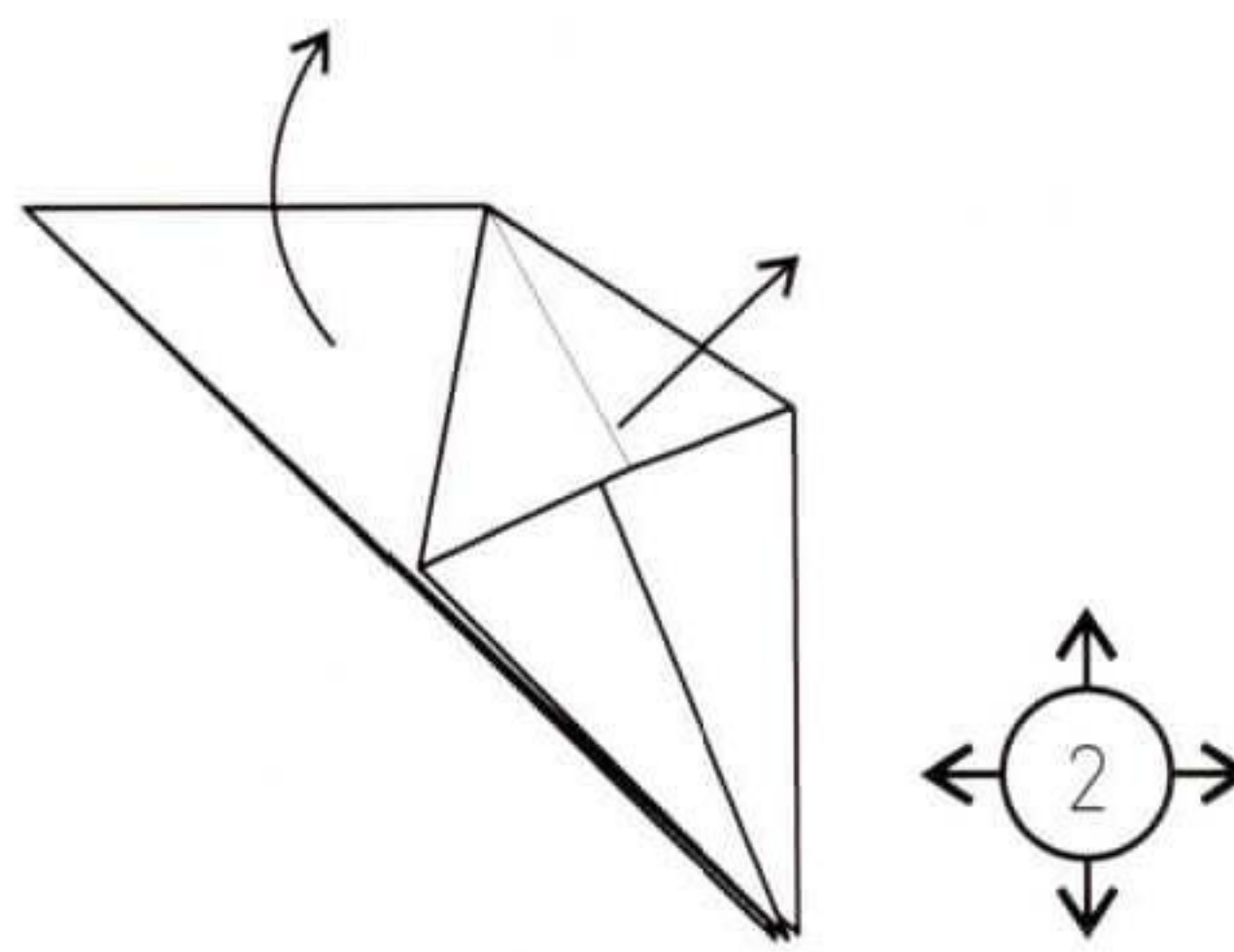

- 5 Unfold the section folded previously. (to step 2).

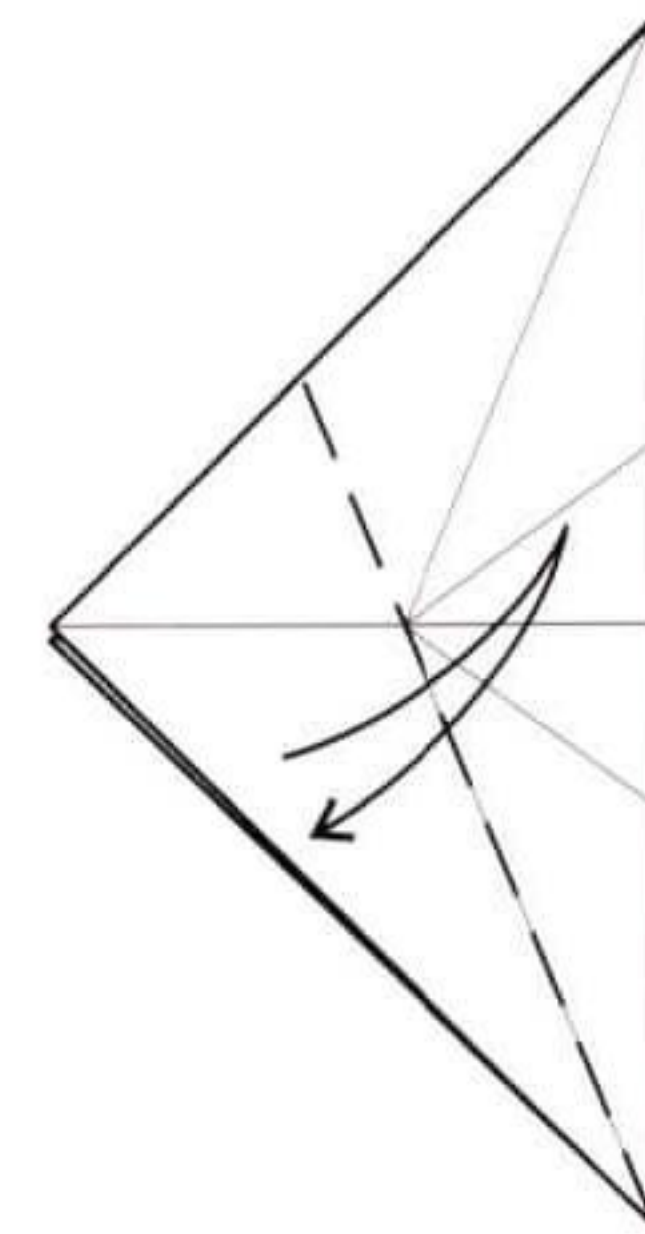

- 6 Fold the upper layer of the lower left side in diagonally to touch the opposite side, and unfold.



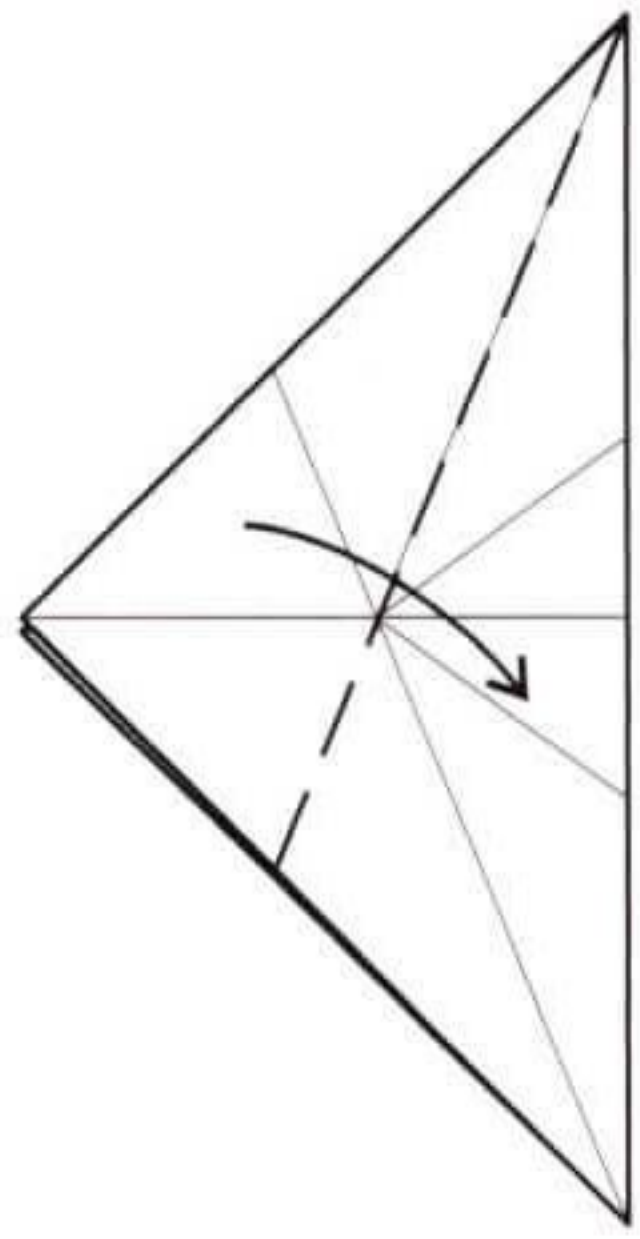

- 7 Fold the upper layer of the upper left edge in diagonally to touch the opposite side.

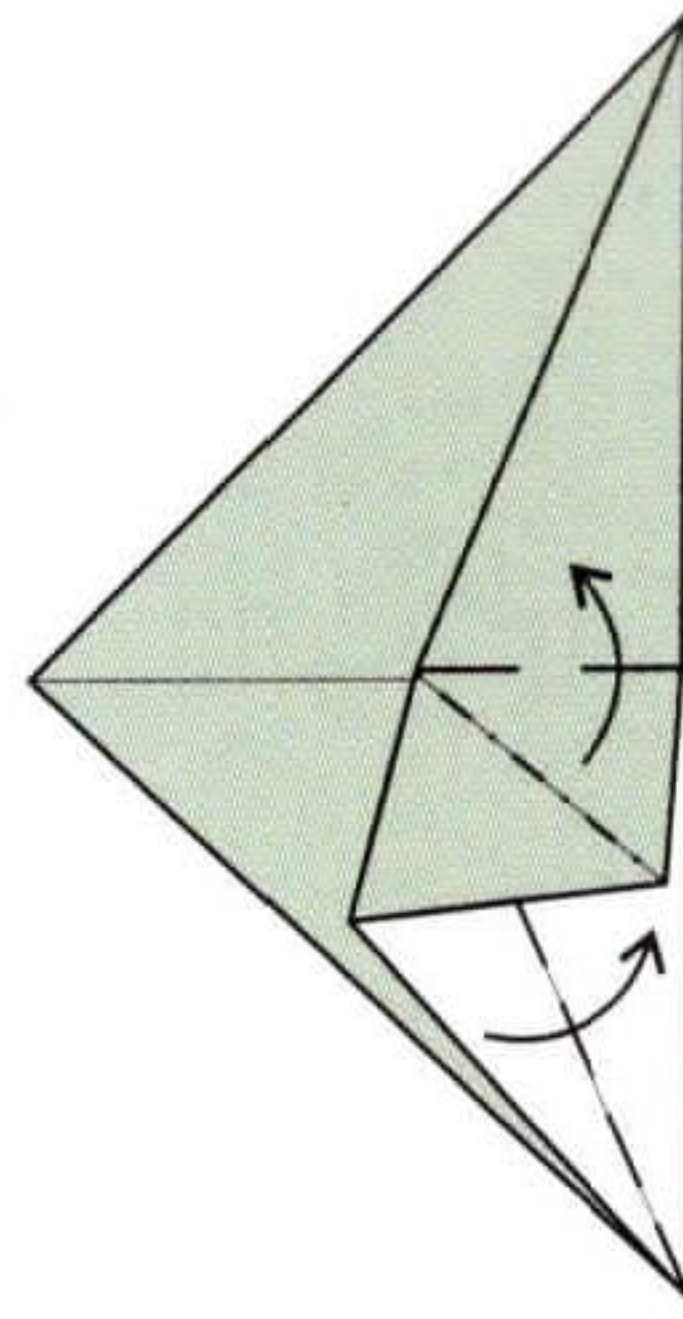

- 8 Fold the middle section up and refold the lower section along the creases made previously.

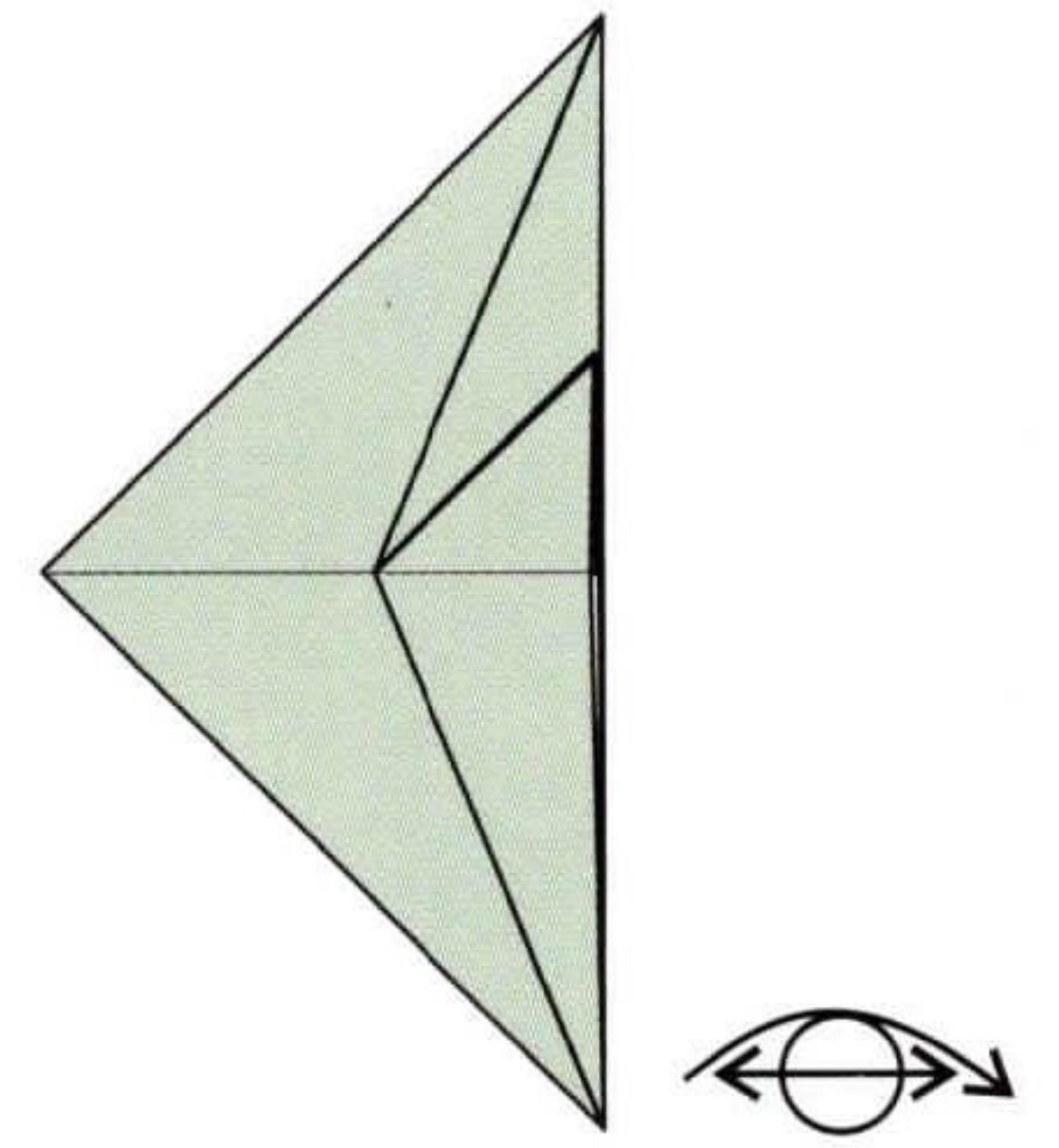

- 9 Turn the model over left to right.

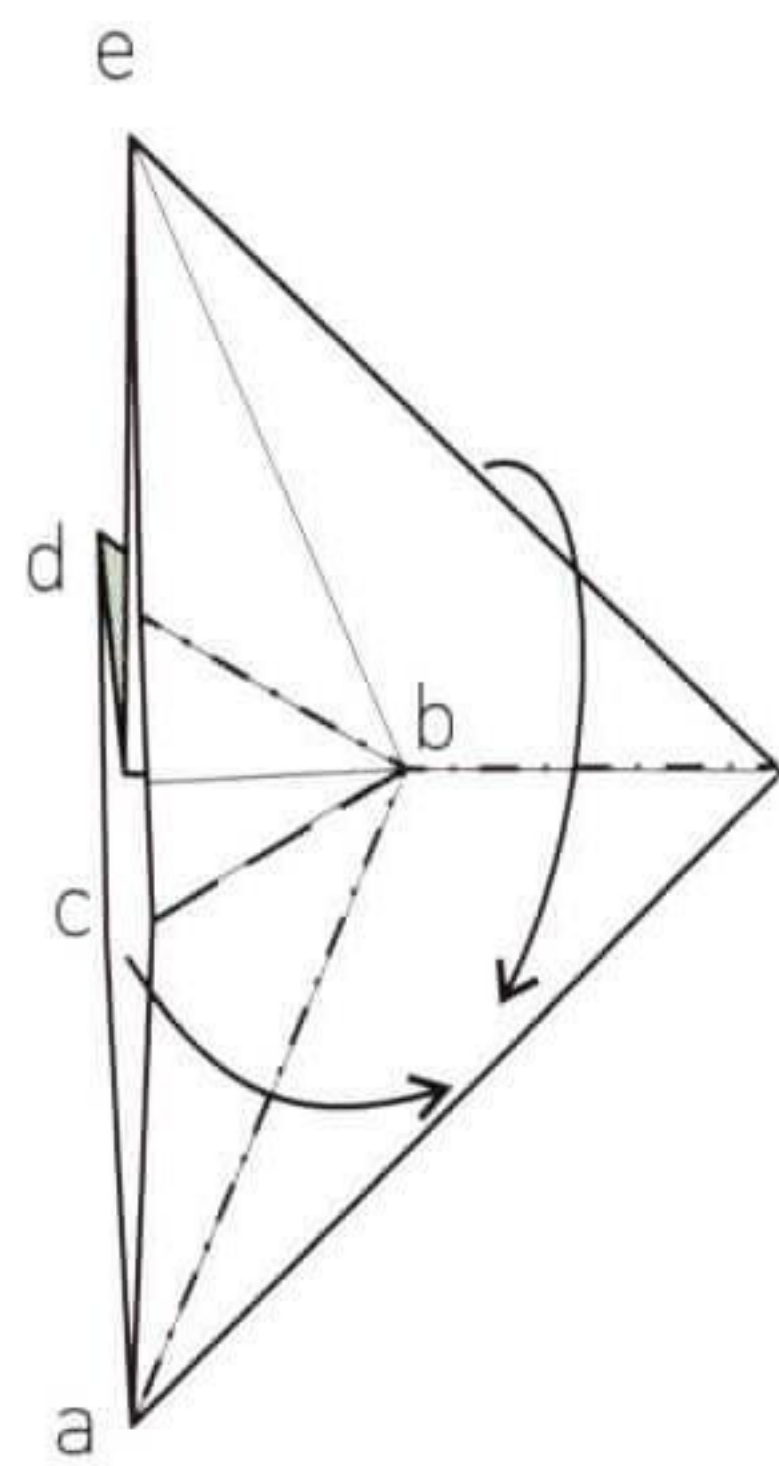

- 10 Fold the upper section down. At the same time fold the section (a-b-c) to the right. The section (b-d-e) should be held together with the upper section.

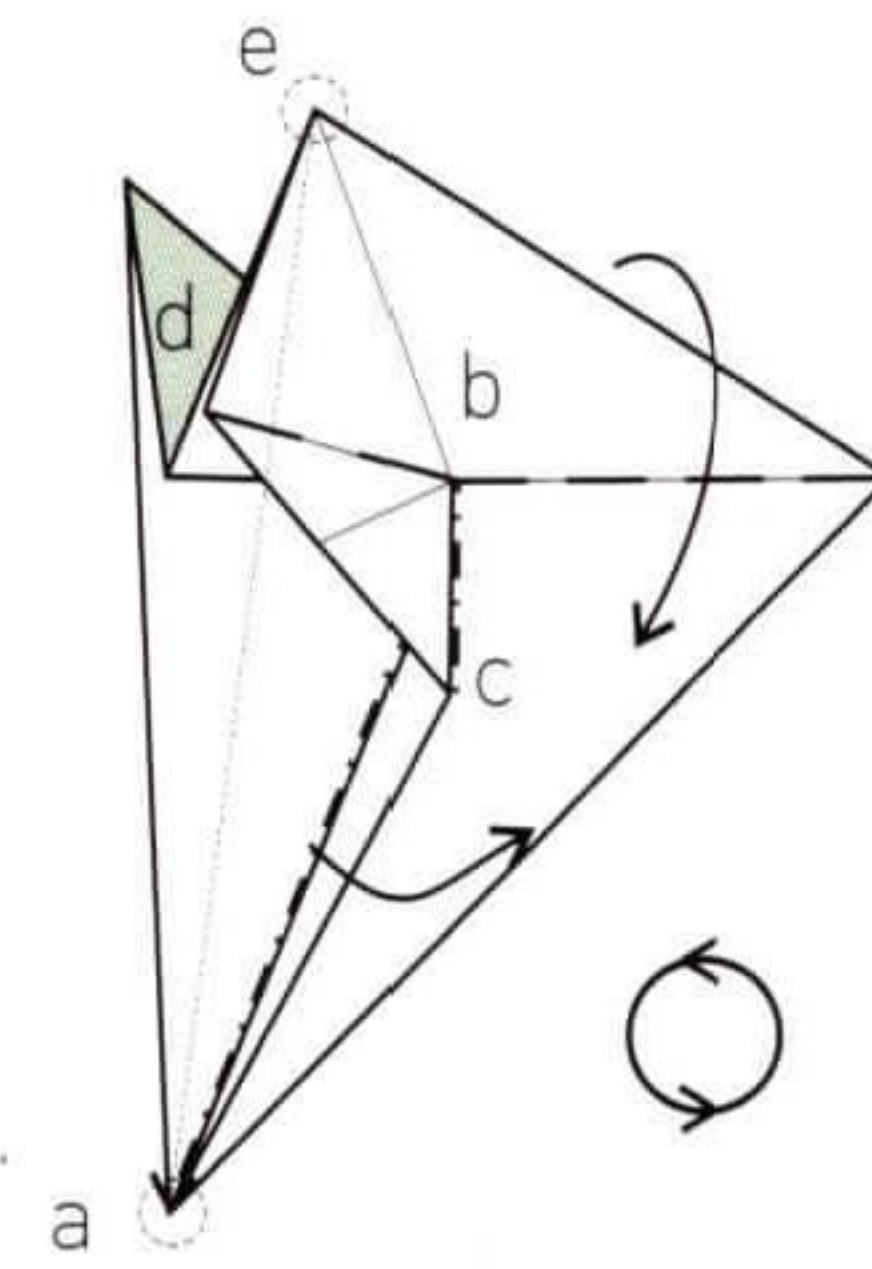

- 11 This shows the fold in progress. When complete, rotate the model slightly.

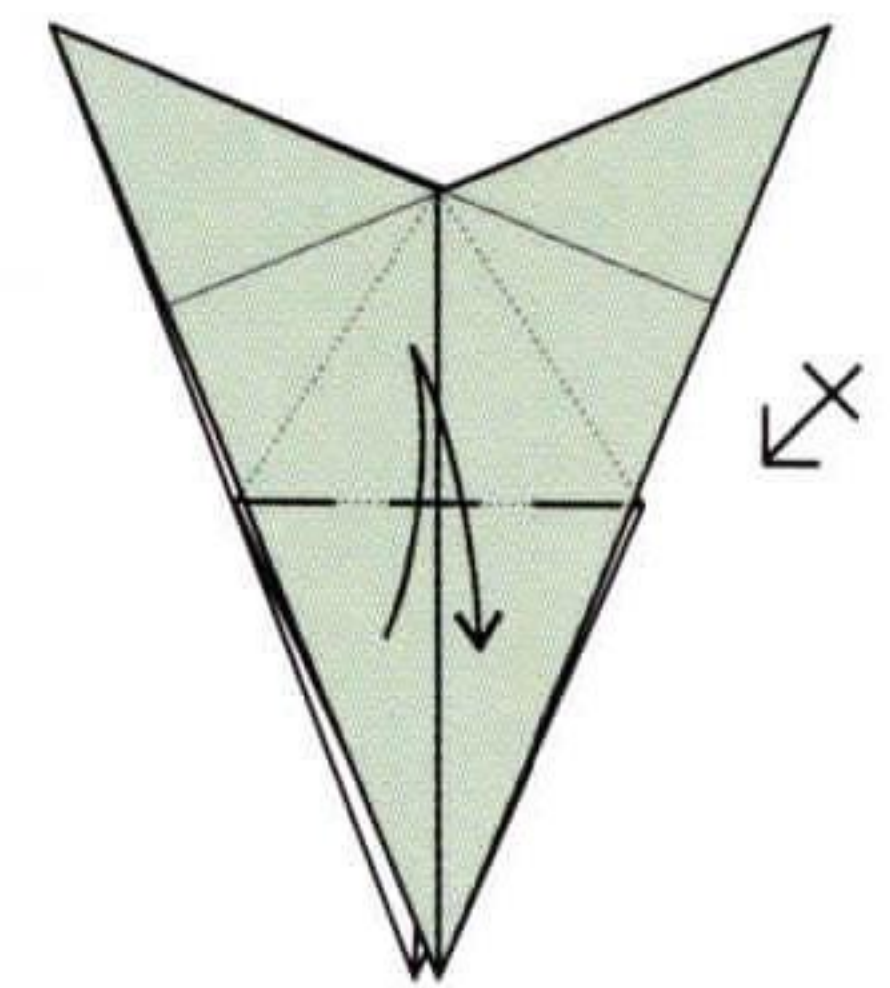

- 12 Fold the lower corner up and down. Repeat on the reverse.

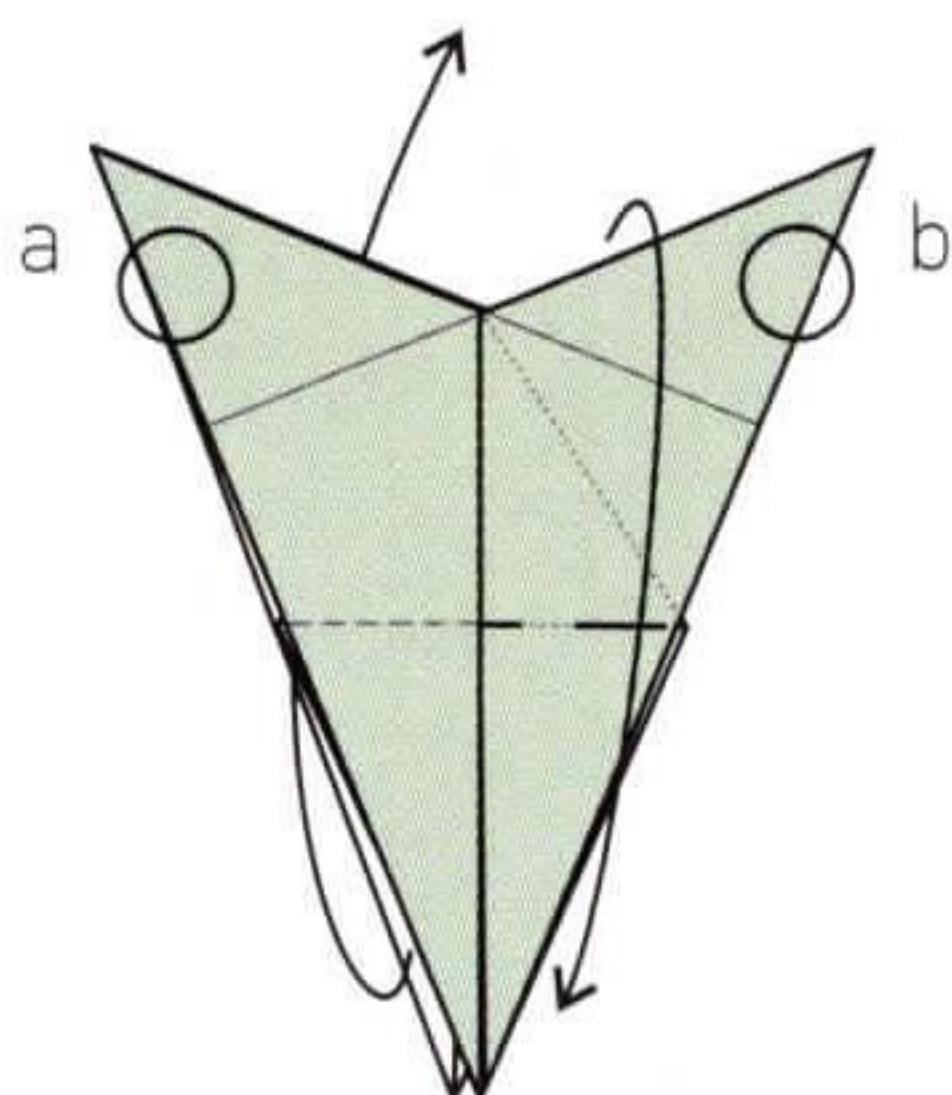

- 13 Hold model at (a) and (b). Fold the right section (b) down while holding the left section (a) still. This twists and opens the model.

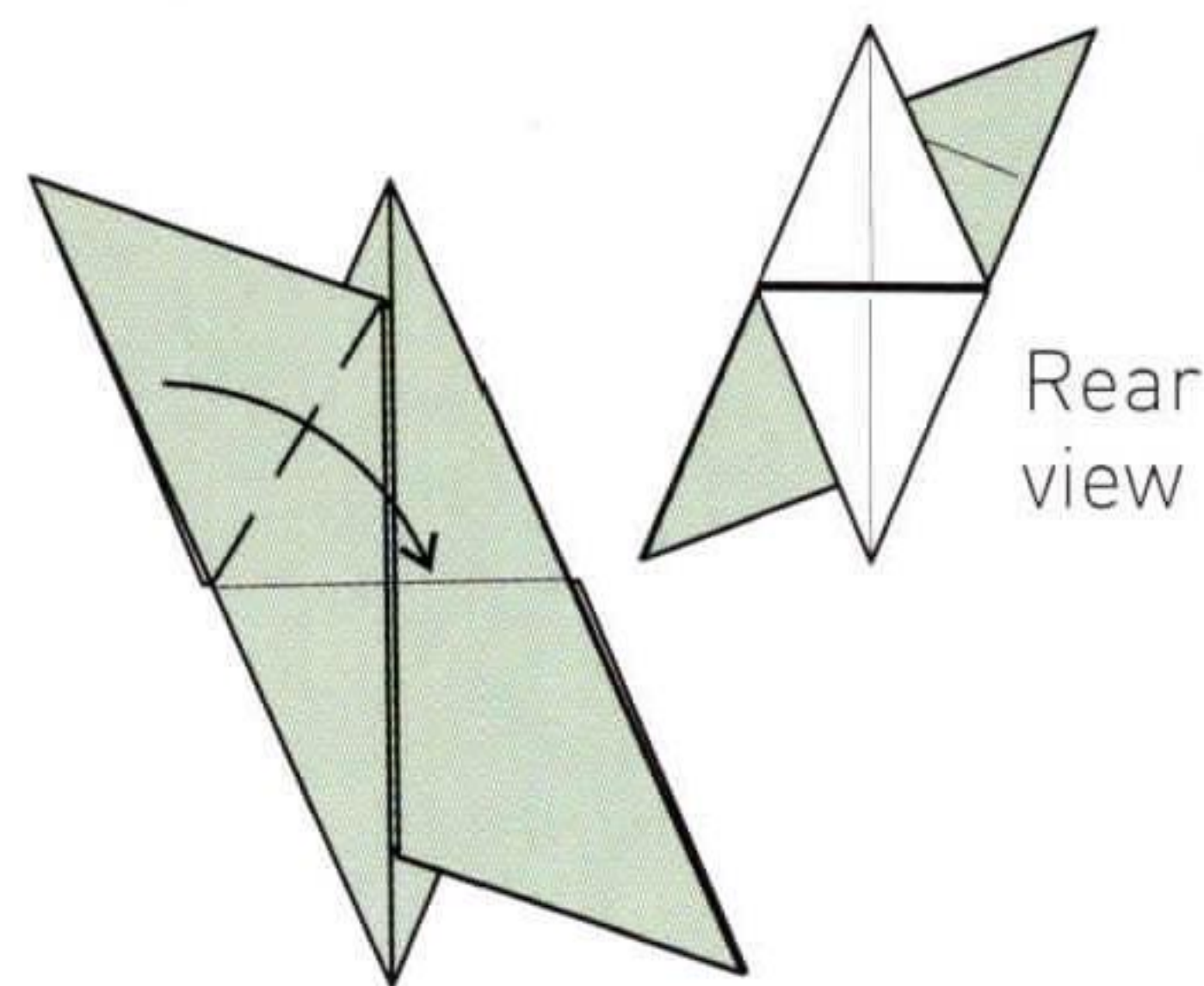

- 14 The twist is complete. Fold the left corner to the right.

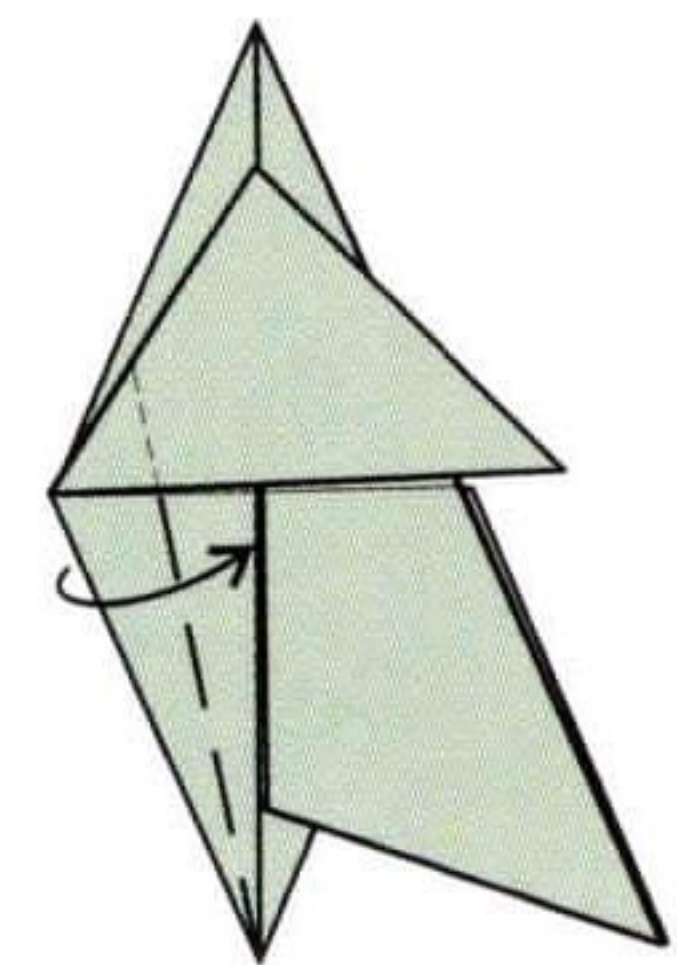

- 15 Fold the upper edge of the lower section in to touch the middle.

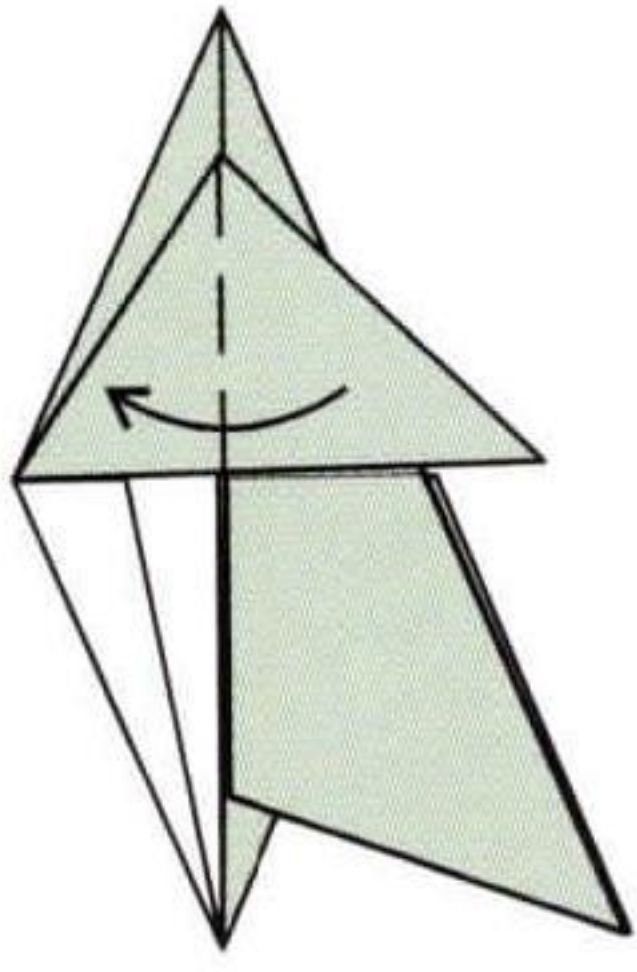

16 Fold the upper corner back.

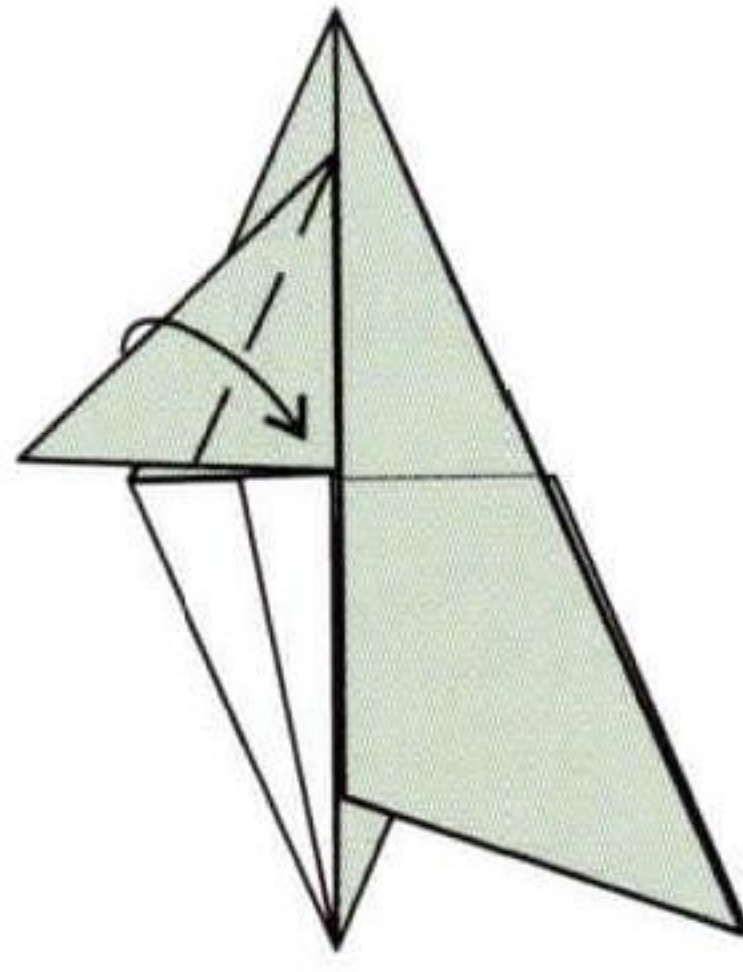

17 Fold the corner in to the adjacent edge.

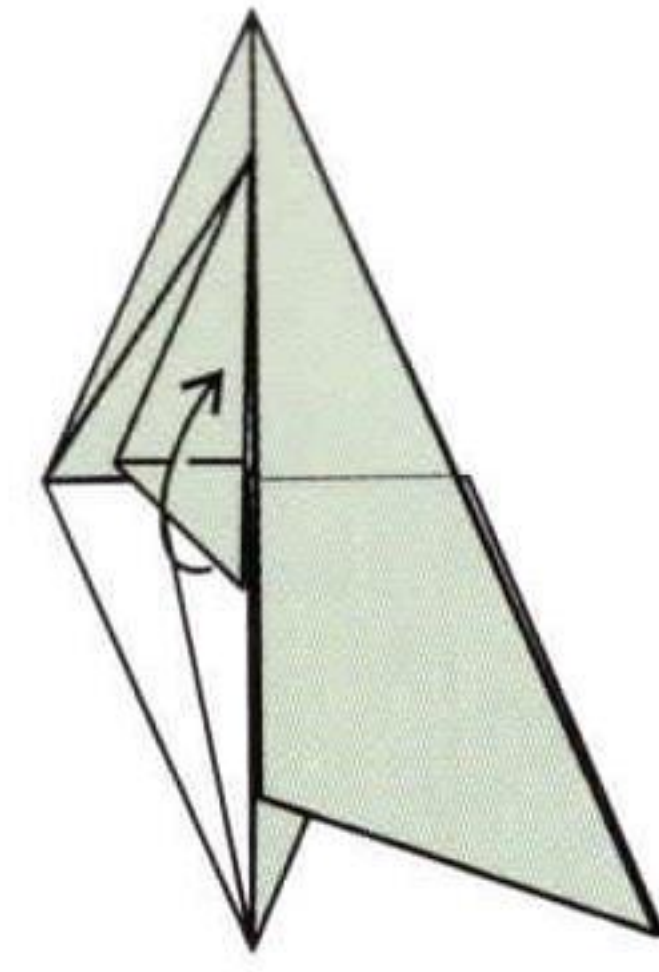

18 Fold the lower corner up.

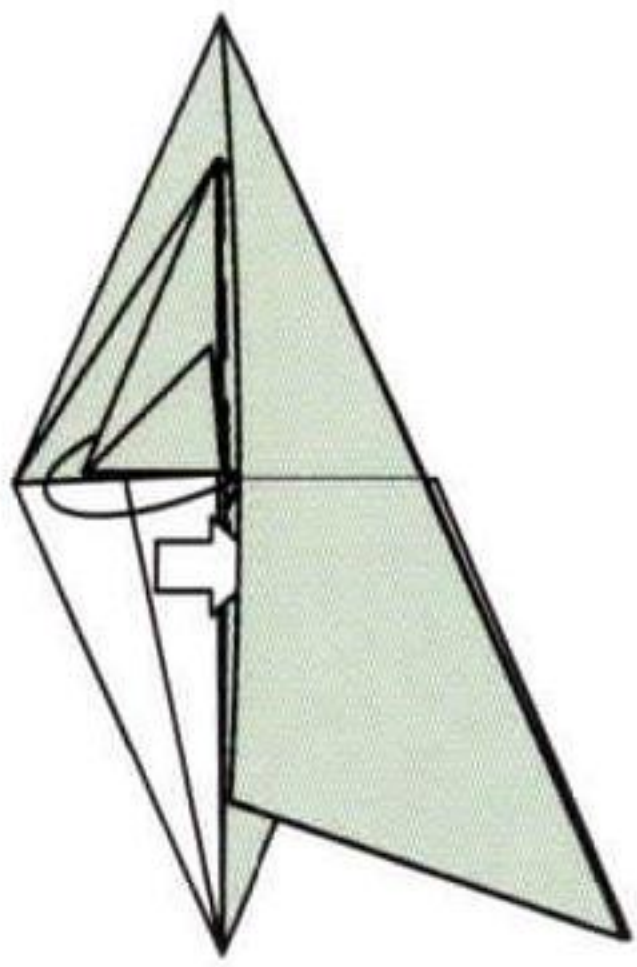

19 Fold edge of the upper section over and into the adjacent pocket. When repeating this step fold the edge into the lower pocket.

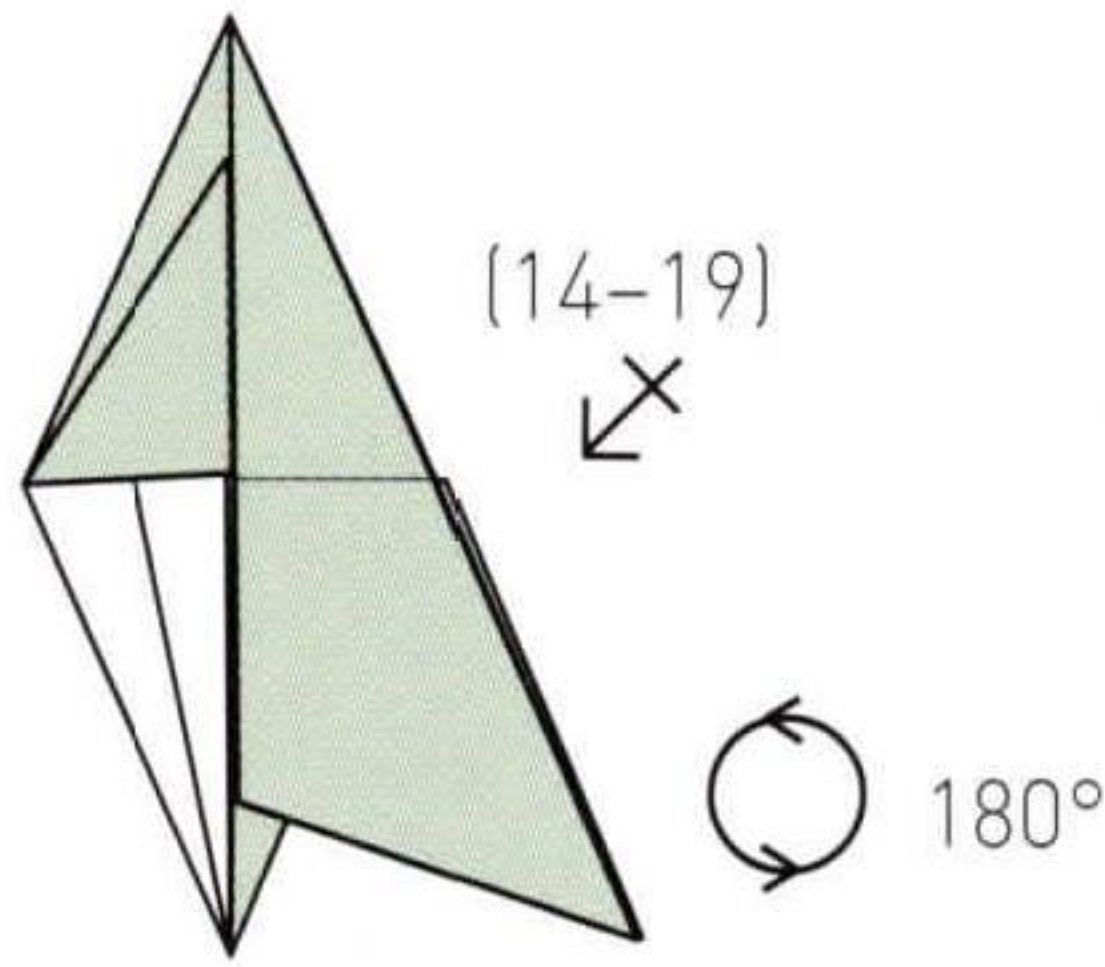

20 Rotate the model by 180°. Repeat steps 14 to 19 on the other side.

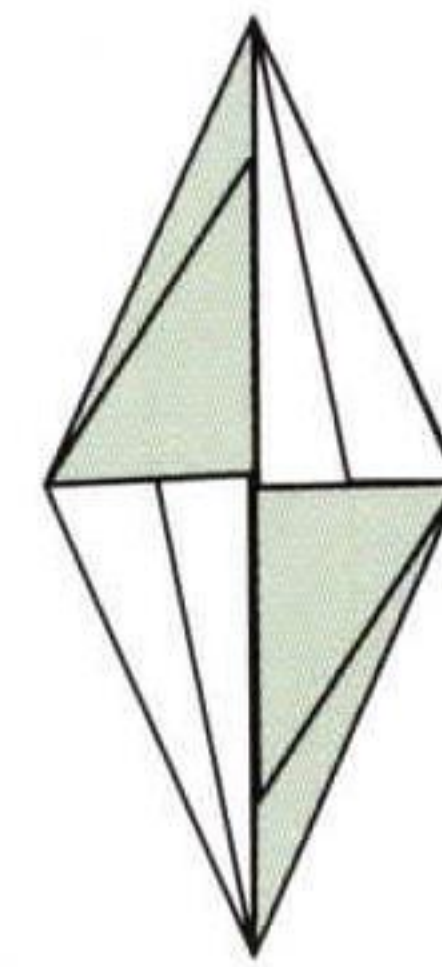

21 Diamond complete.

SIXTEEN UNITS CAN BE JOINED TOGETHER TO FORM A RING

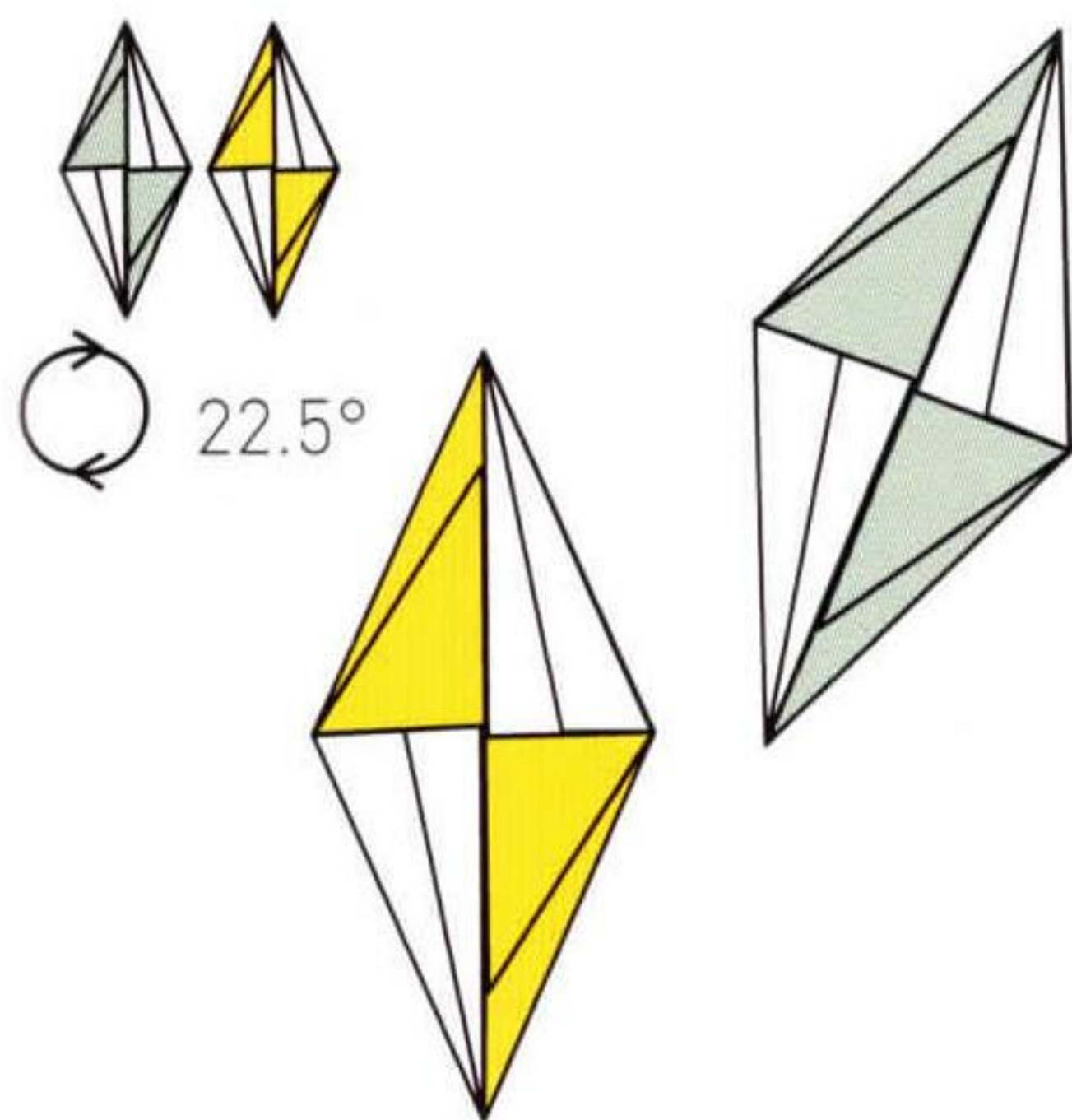

1 Rotate one unit 22.5° and insert its lower point into the pocket in the upper white section of the next unit.

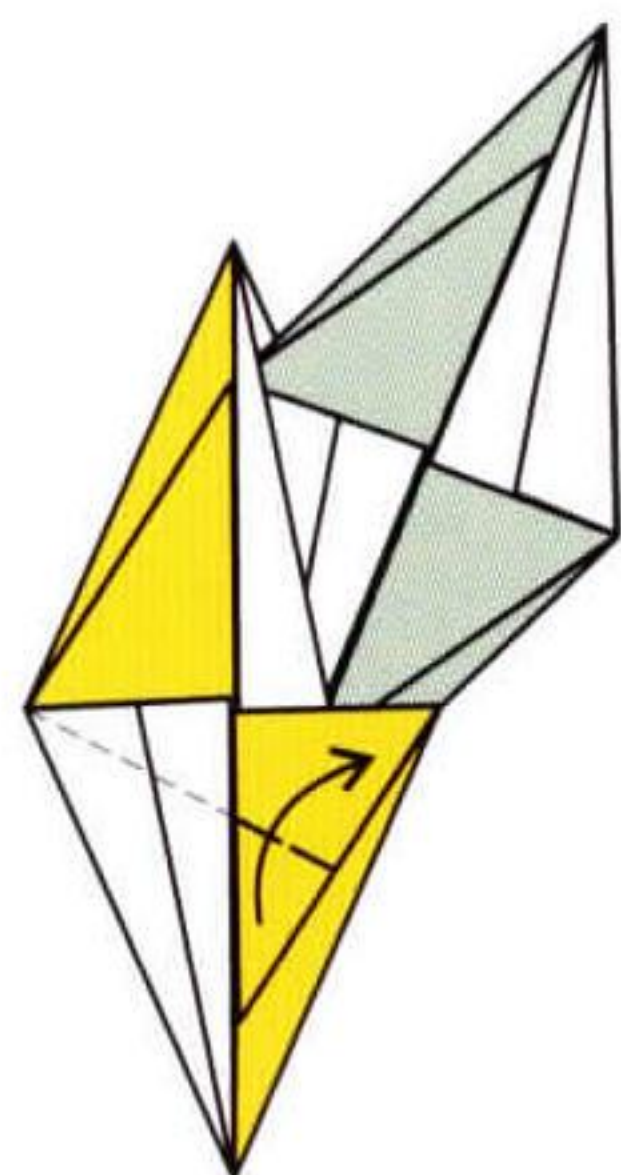

2 Fold up the point in the lower section of the yellow diamond to link the diamonds together. Then add another unit.

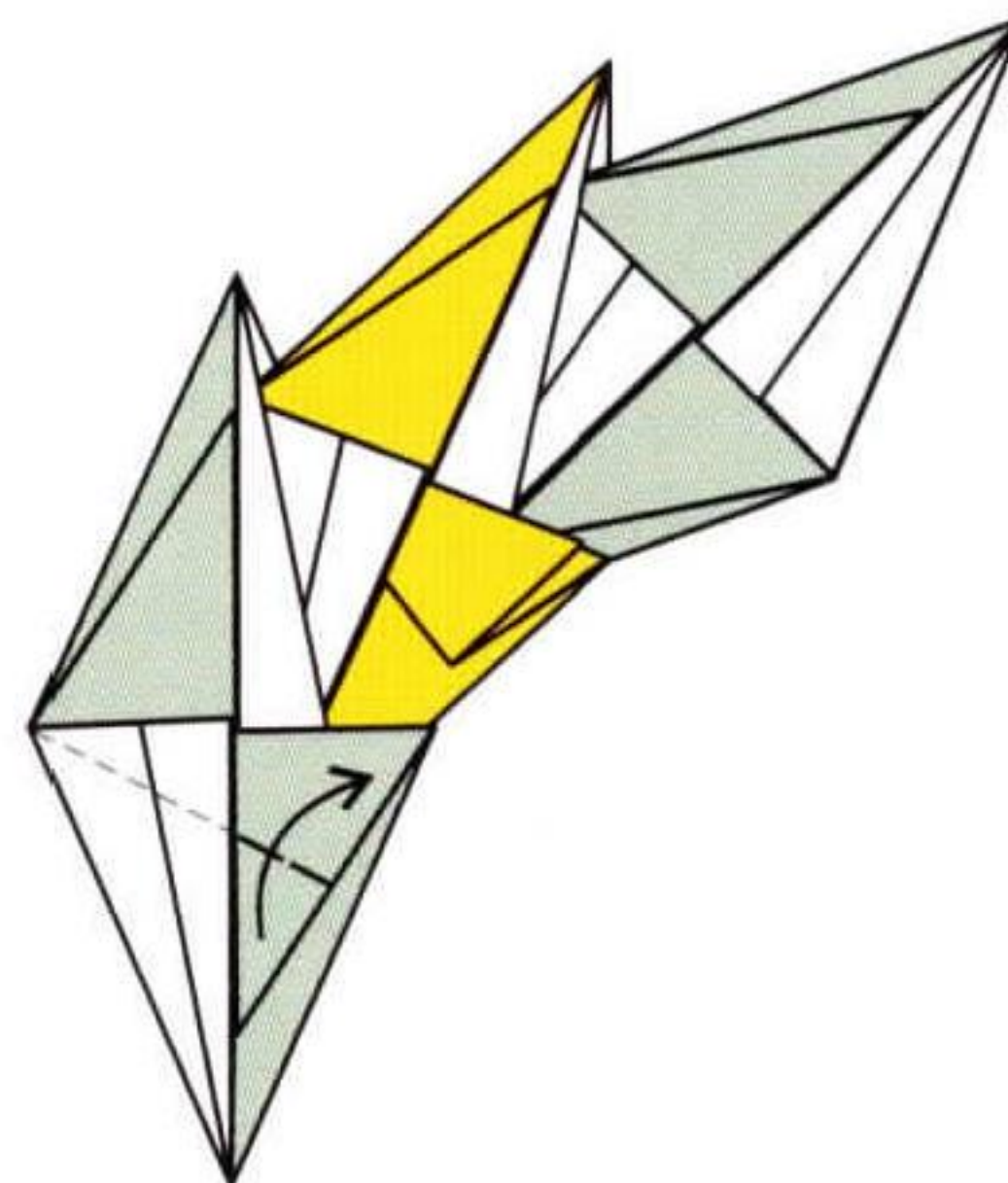

3 Fold over the lower corner to lock the two units together. Then add more units, repeating the linking process.

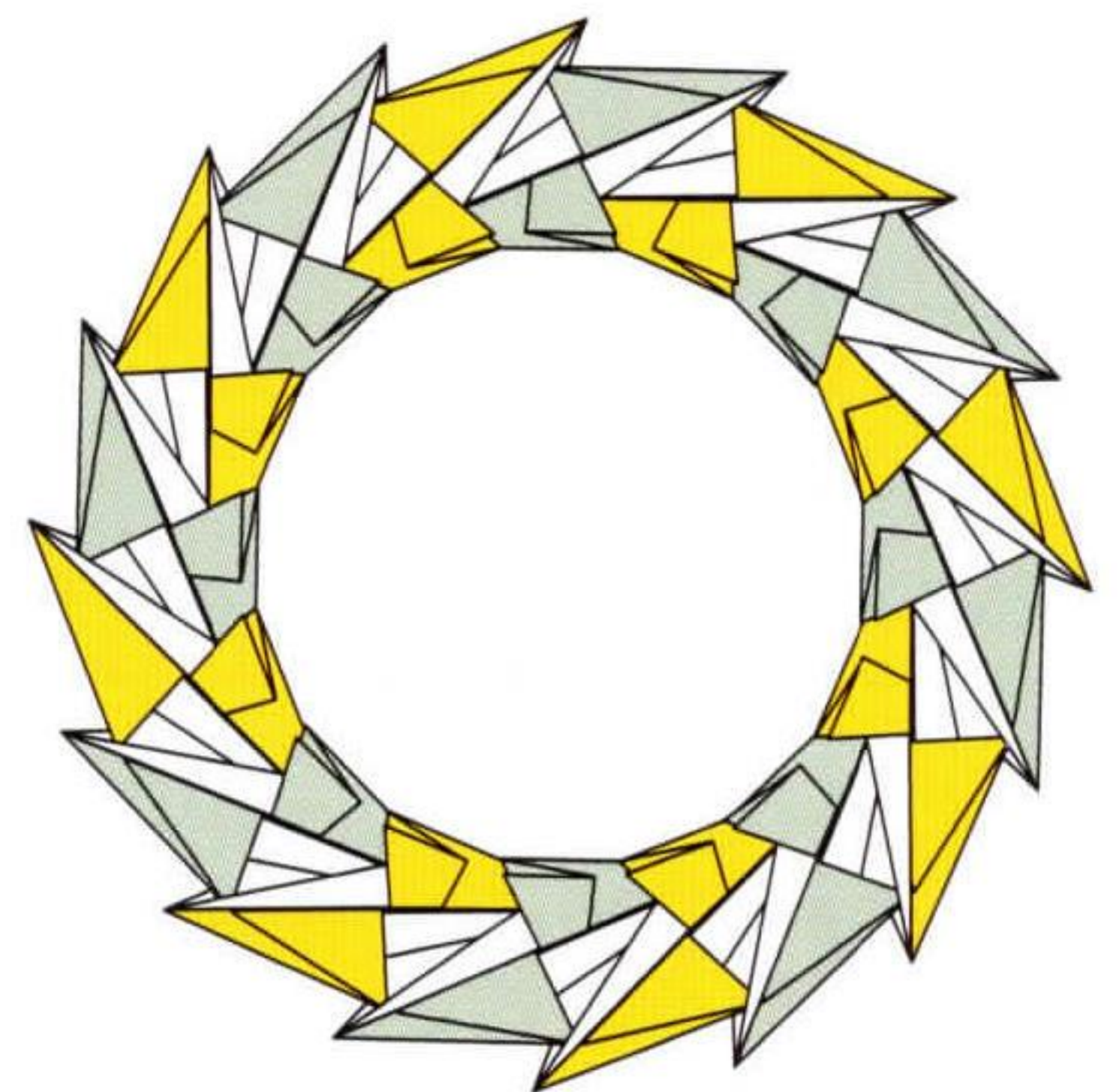

4 Repeat this process to join 16 units together to form a wreath.

MODULAR PROJECTS

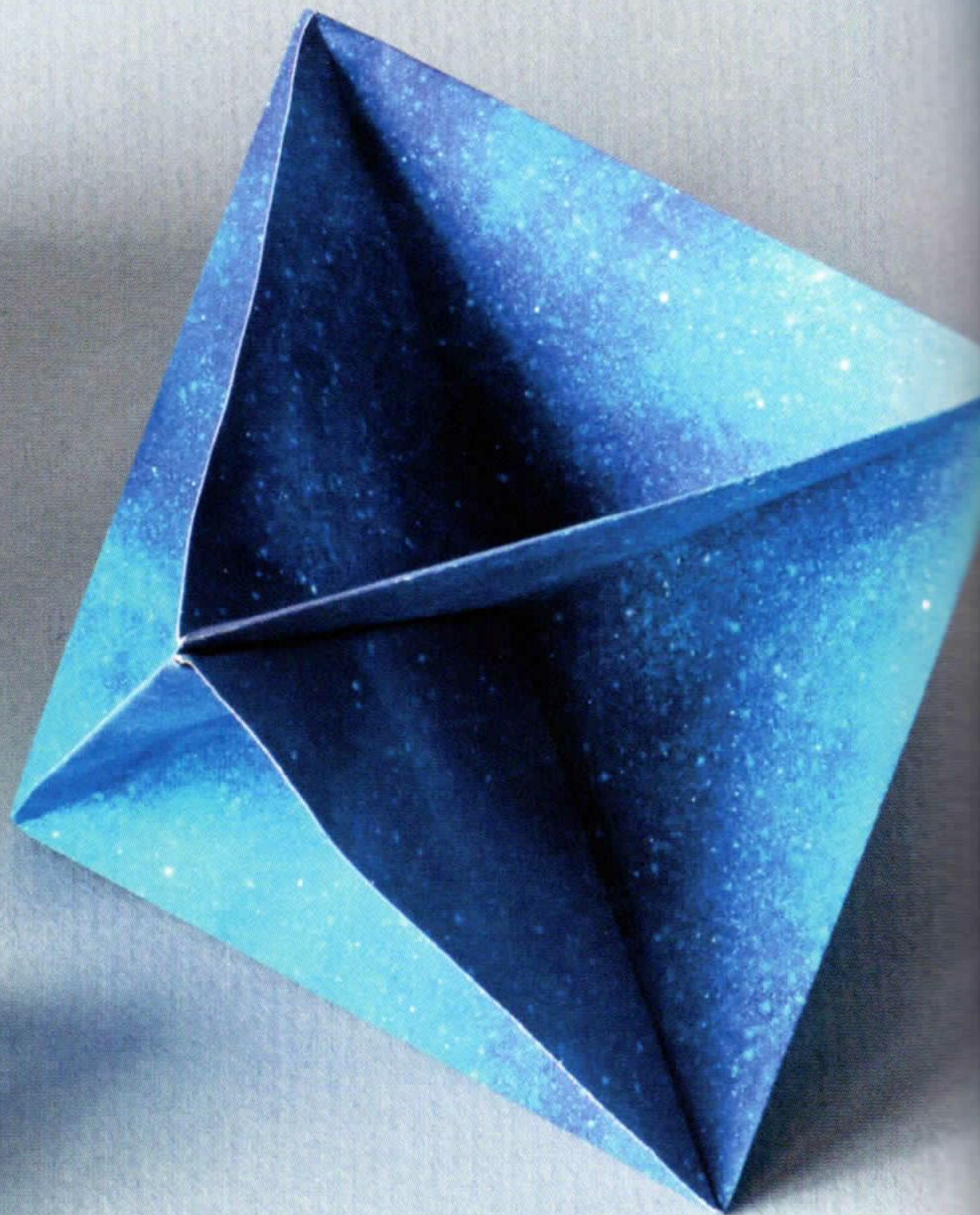
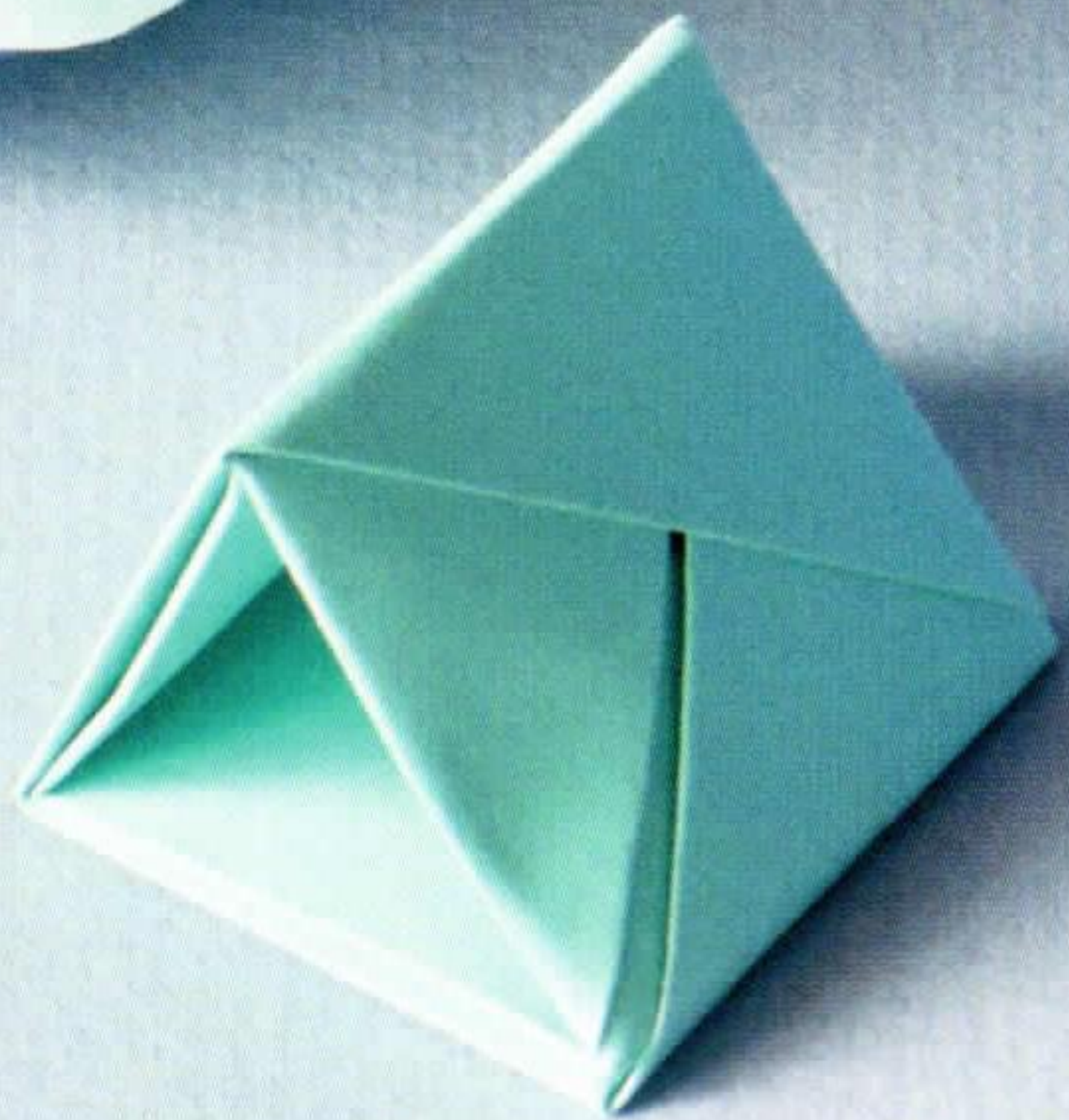

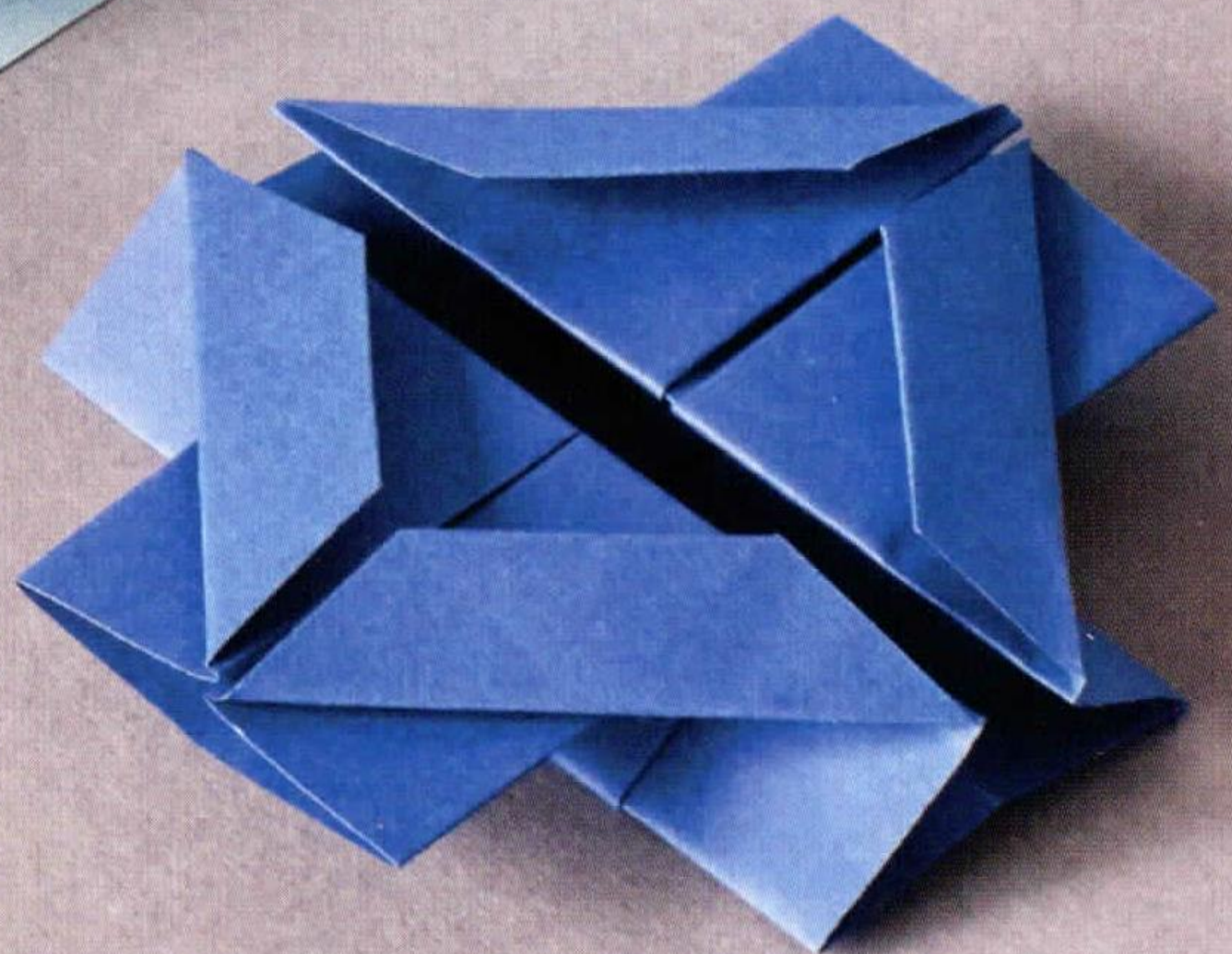
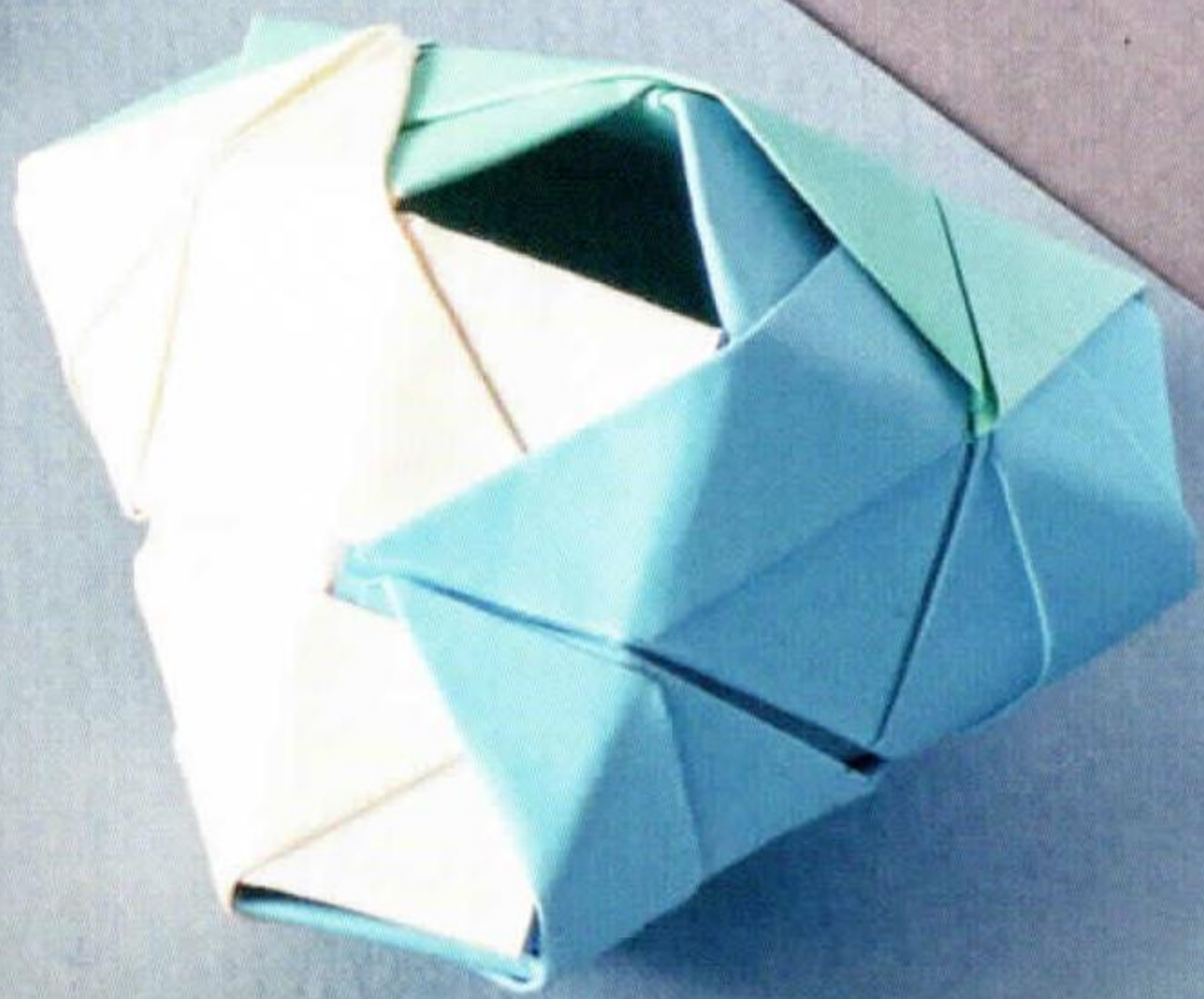
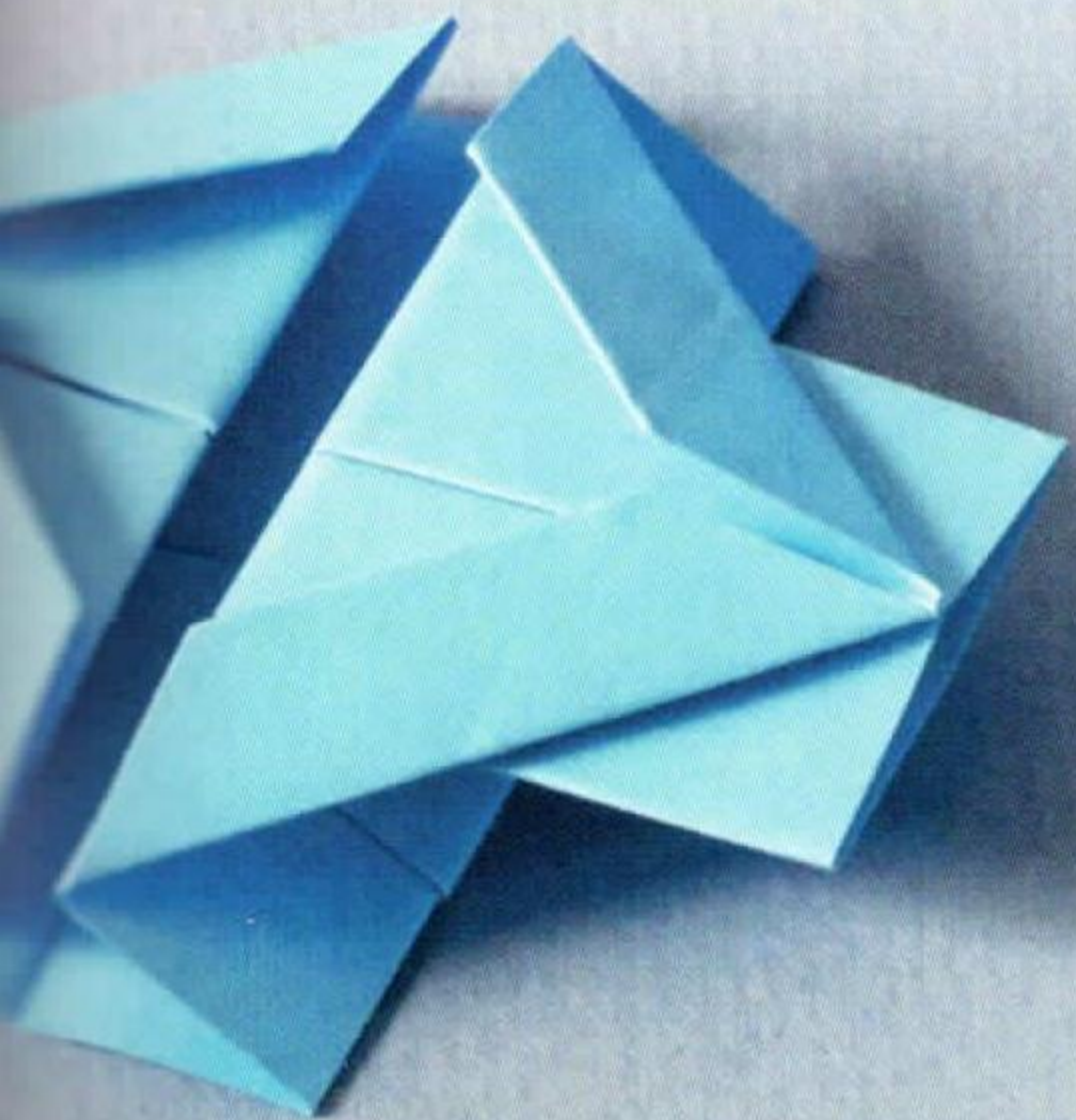
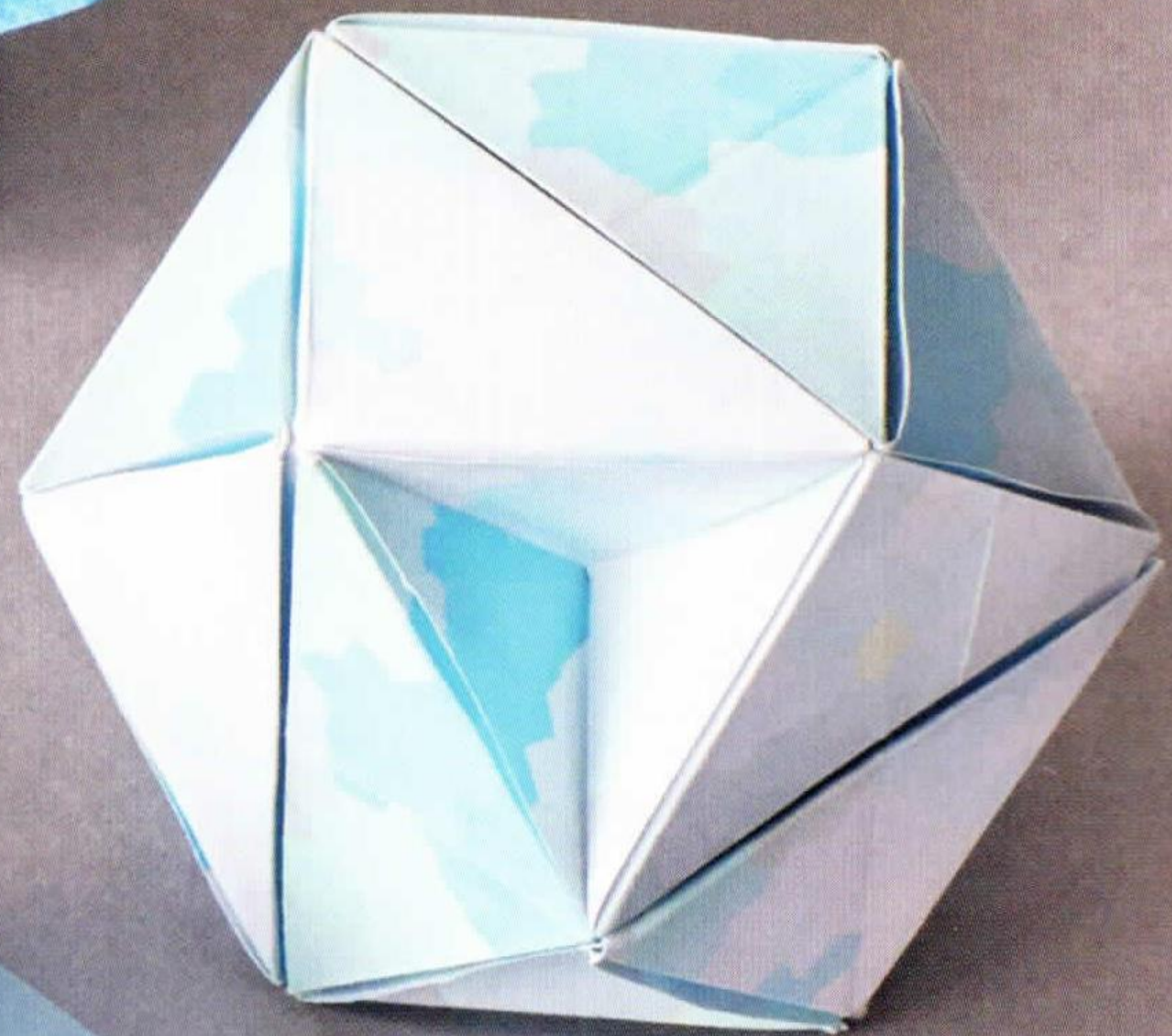
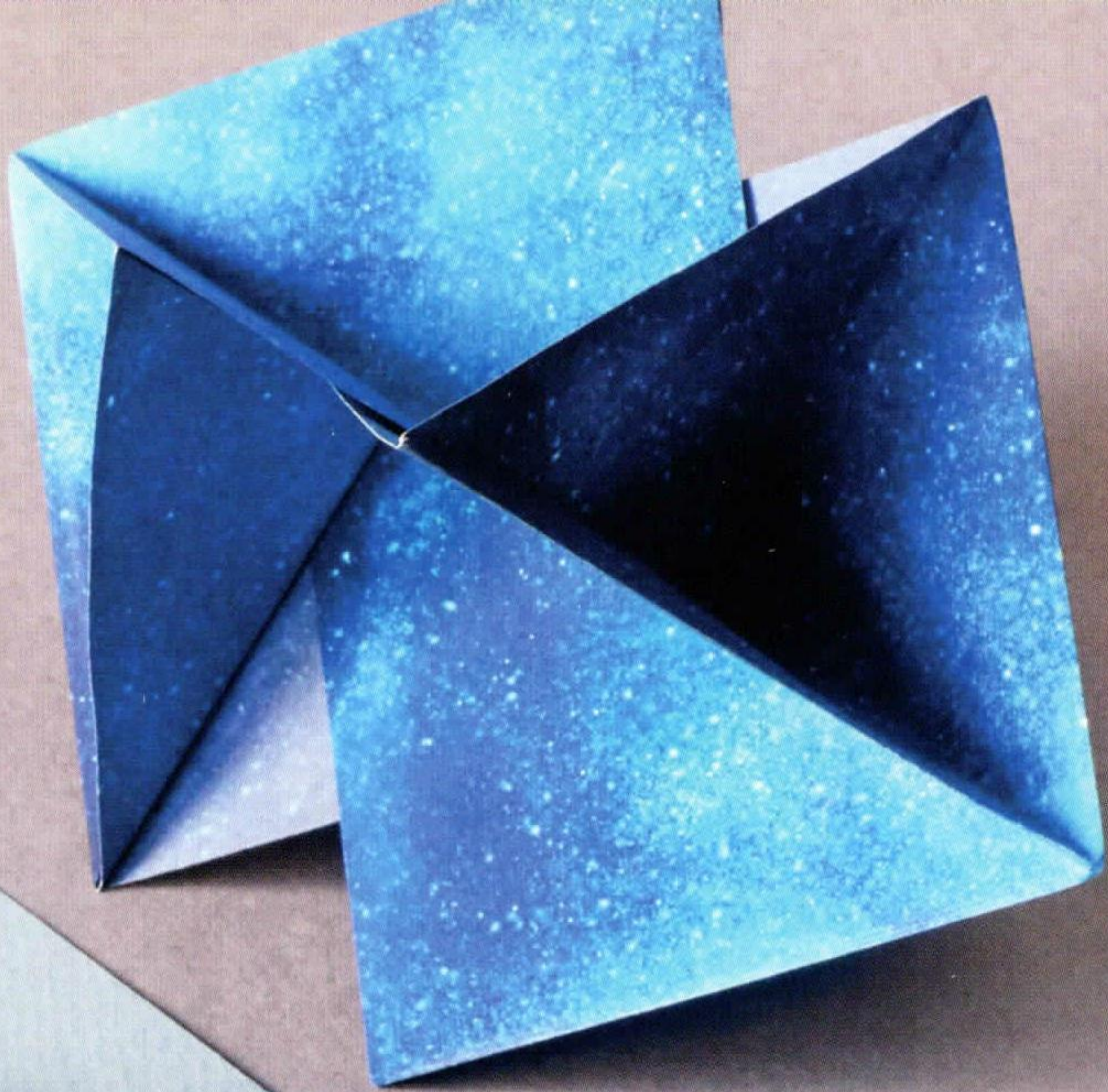

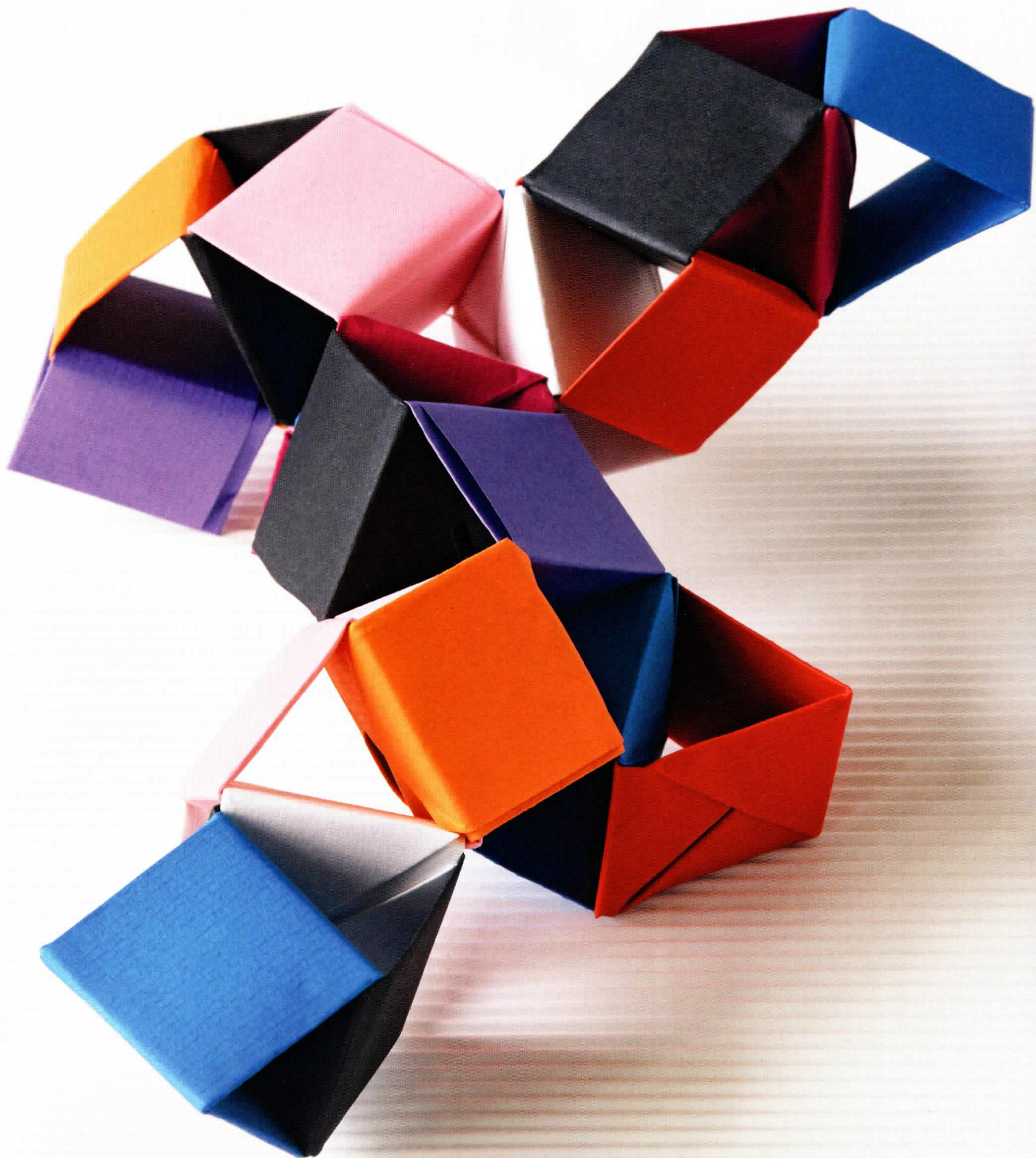

Crystal

*

The crystal explores a potentially infinite modular construction: each unit provides an opportunity to add two more units. As you develop the model think about complementary and contrasting colour choices for the additional components.

18 X 18CM (7 X 7IN)

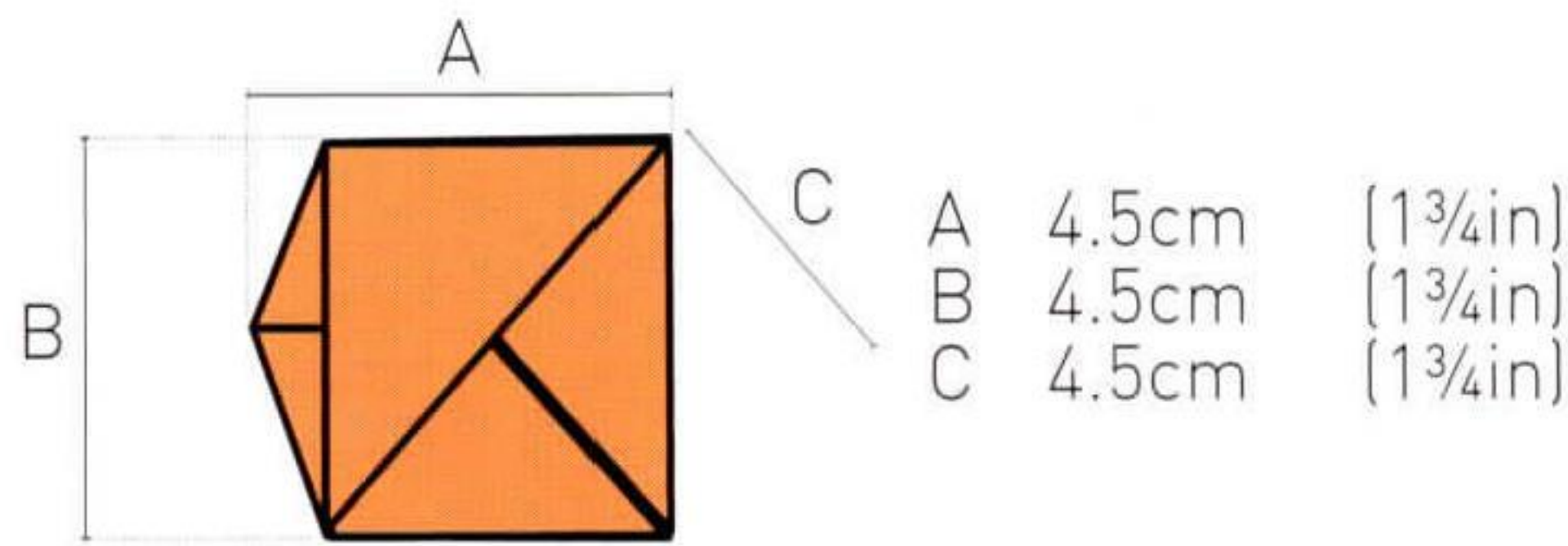
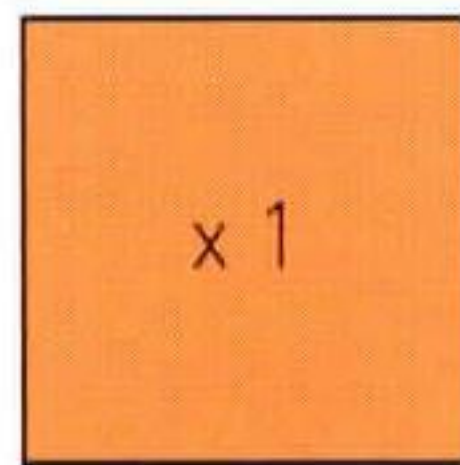

START WITH A SQUARE, COLOURED SIDE UP.

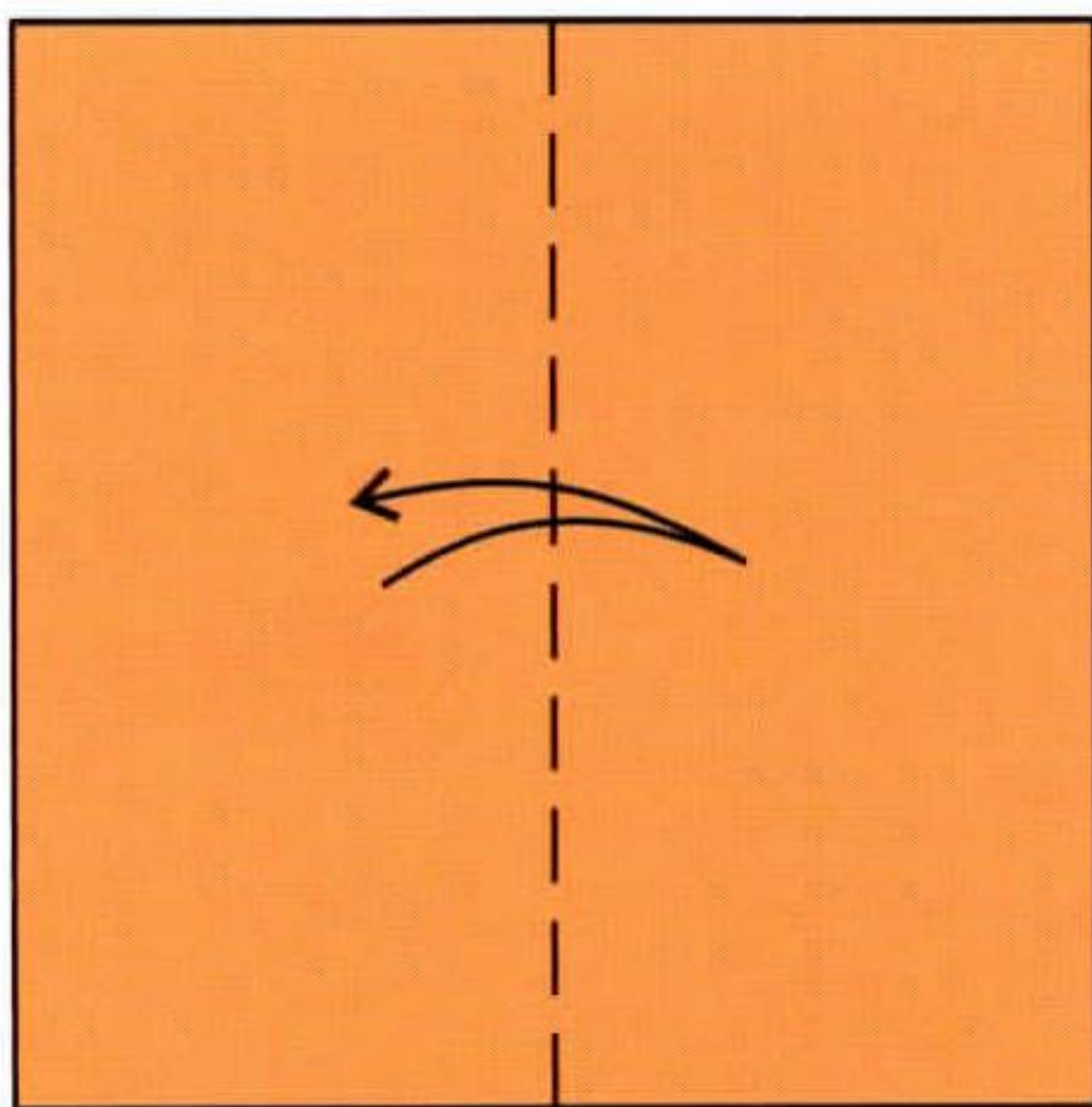

- 1 Fold and unfold the square in half lengthwise.

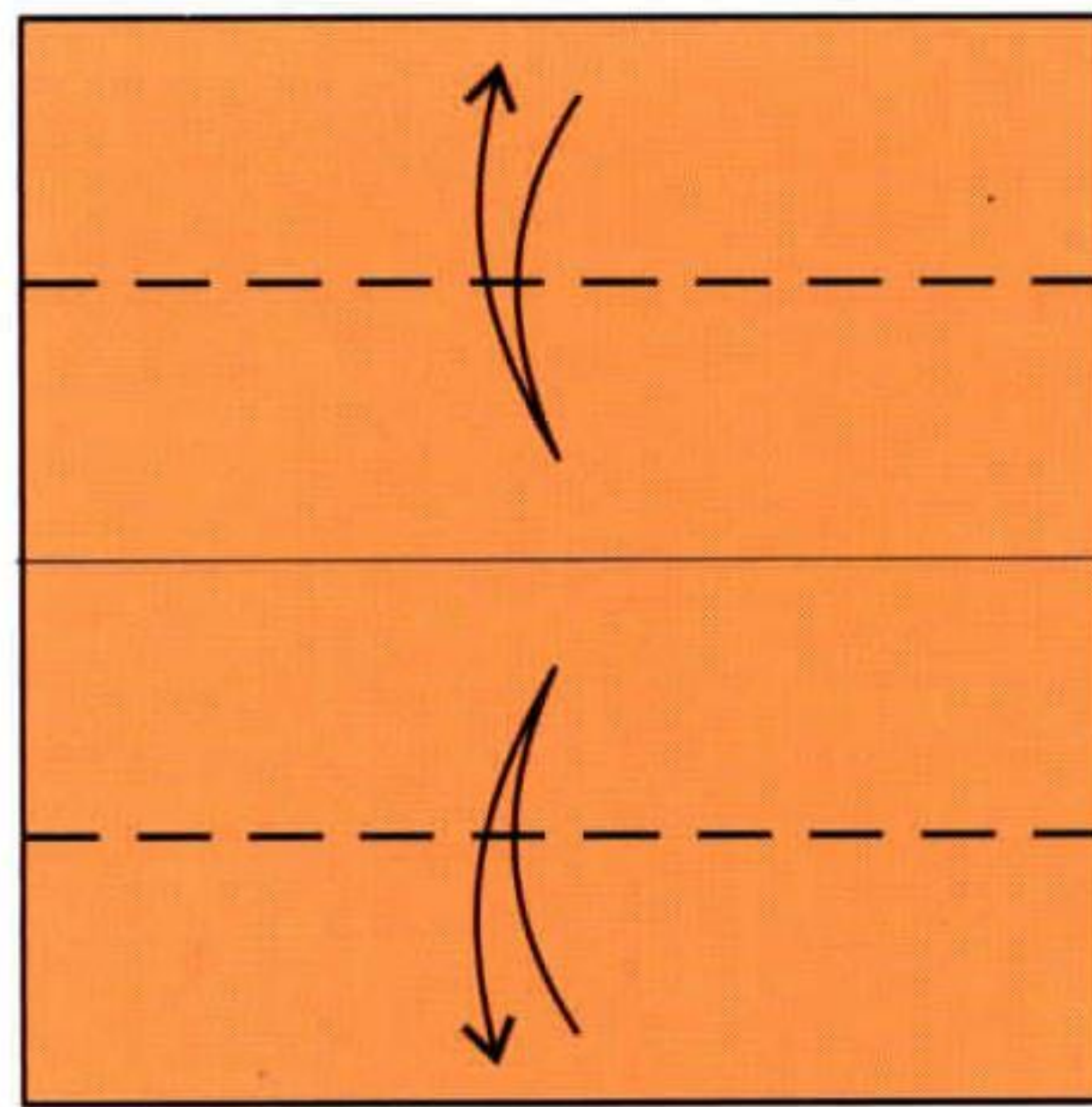

- 2 Fold the edges to touch the middle crease and unfold. Then turn the model over left to right.

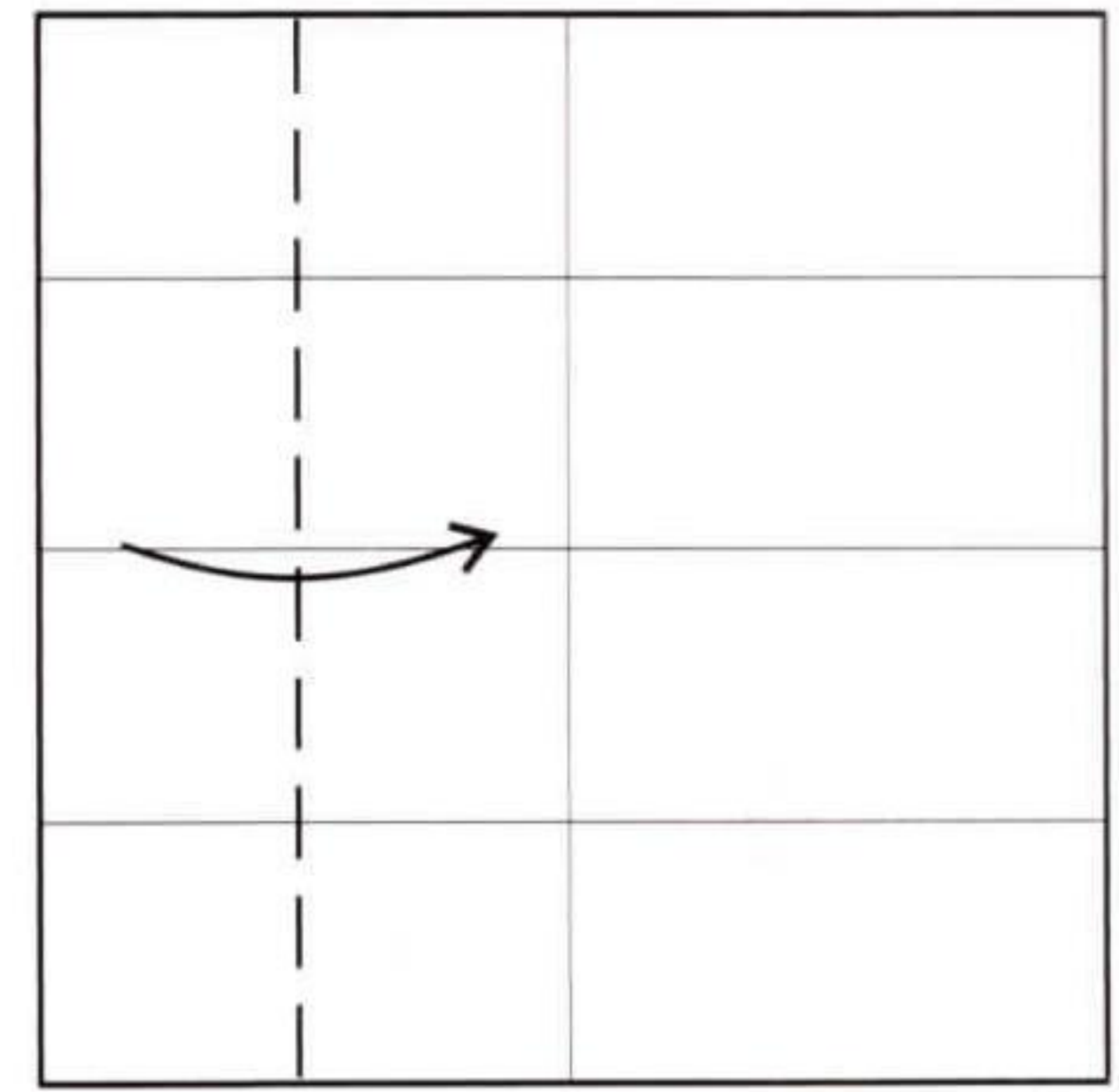
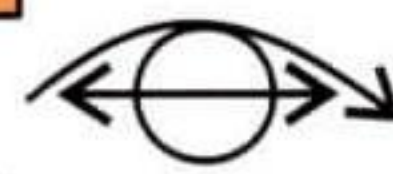

- 3 Fold the left edge in to touch the middle crease.

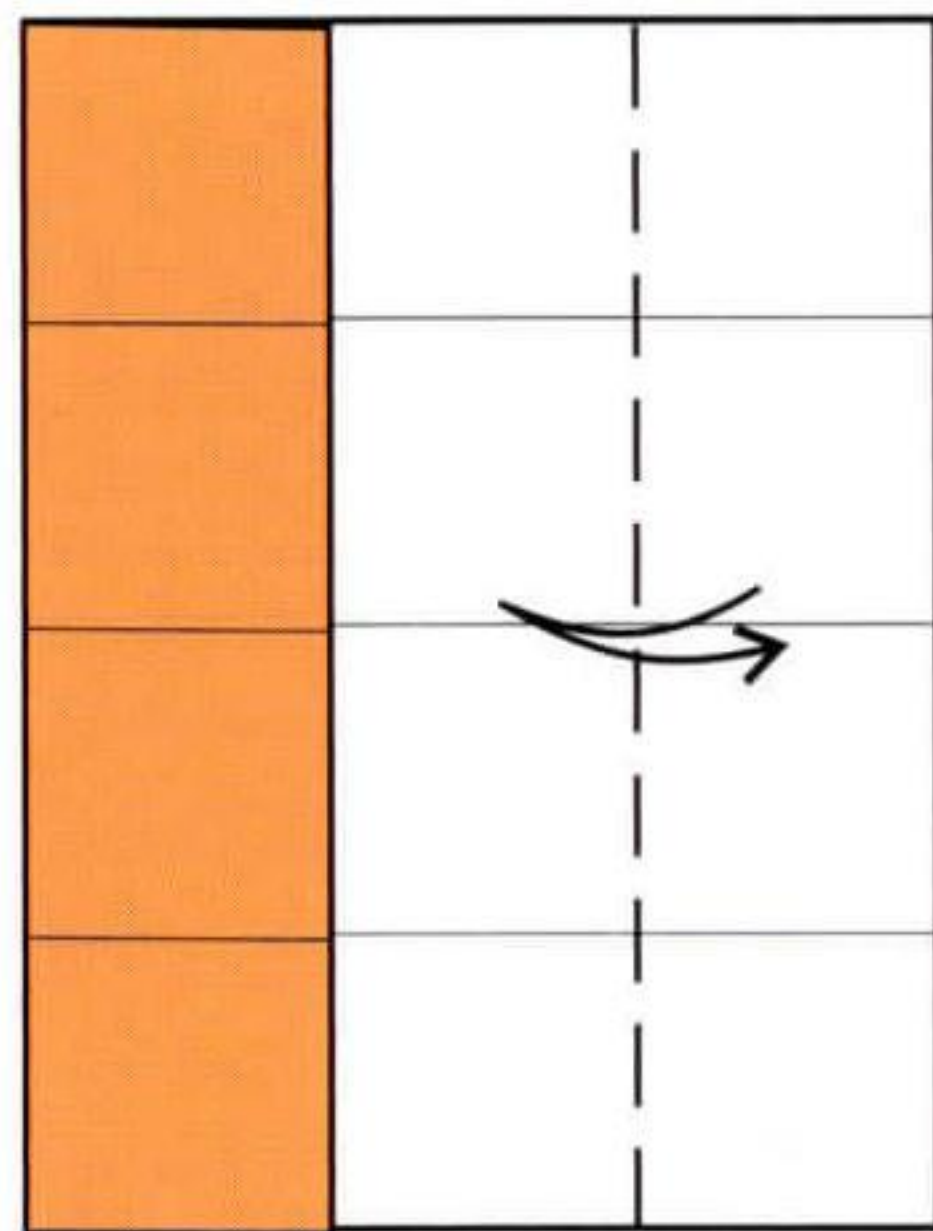

- 4 Fold and unfold the edge in to touch the middle crease.

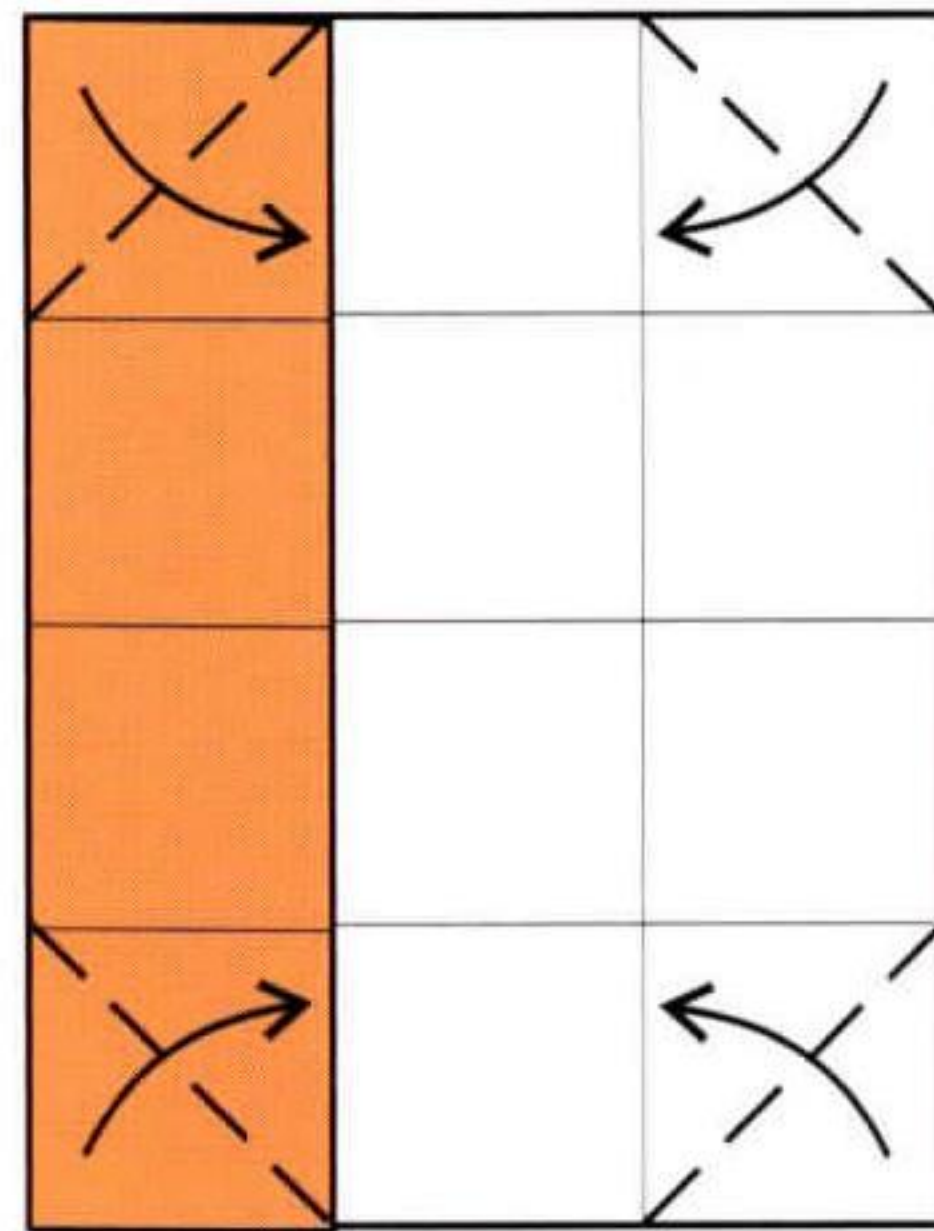

- 5 Fold all the corners in.

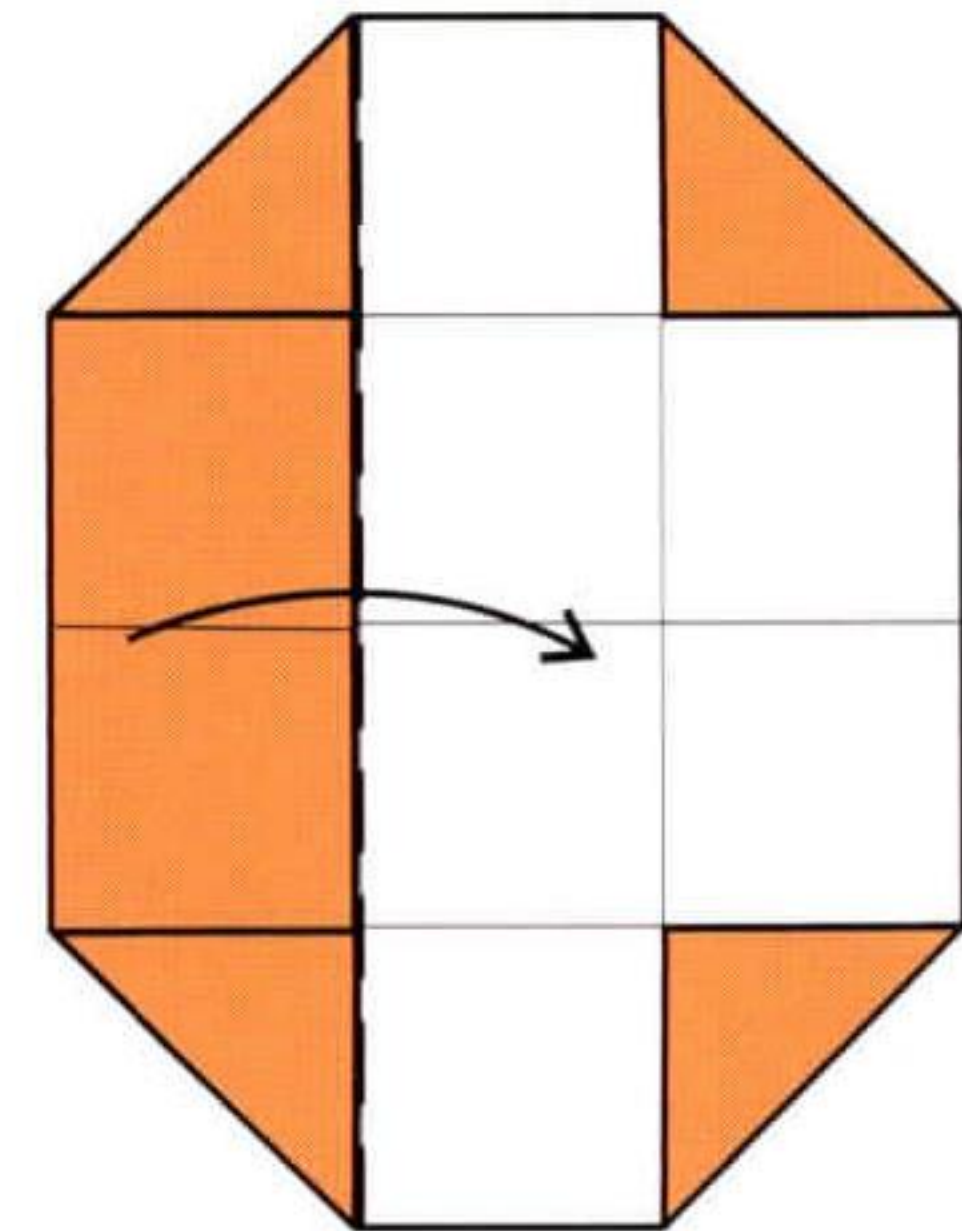

- 6 Fold one side in.

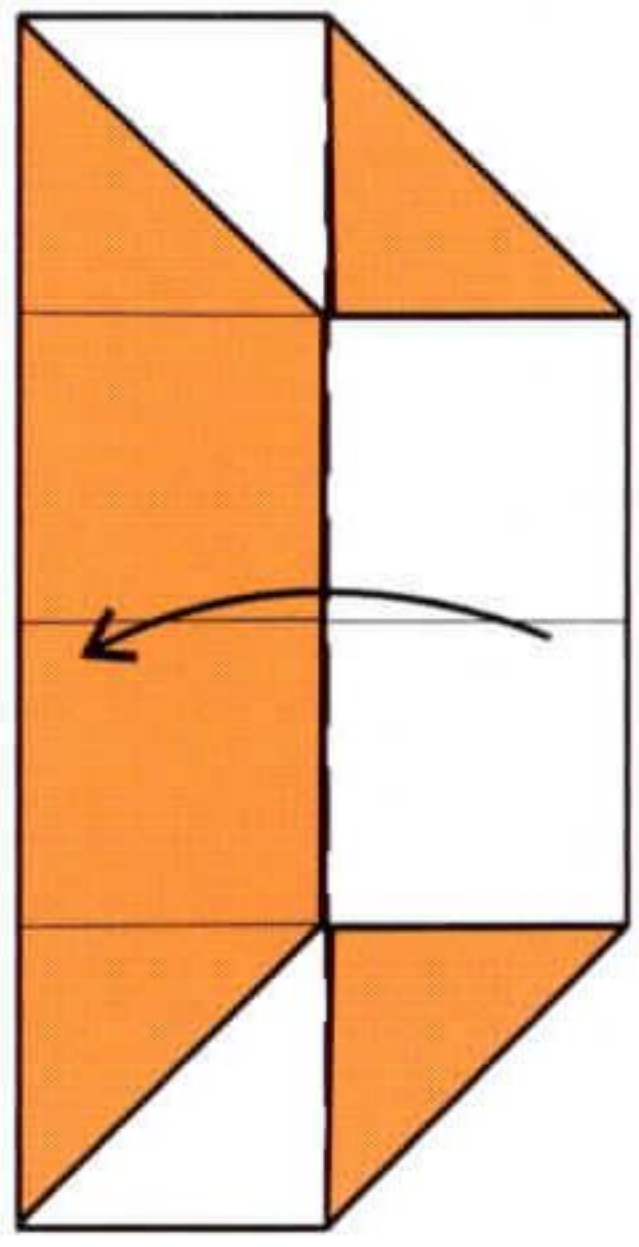

7 Fold the other side over.

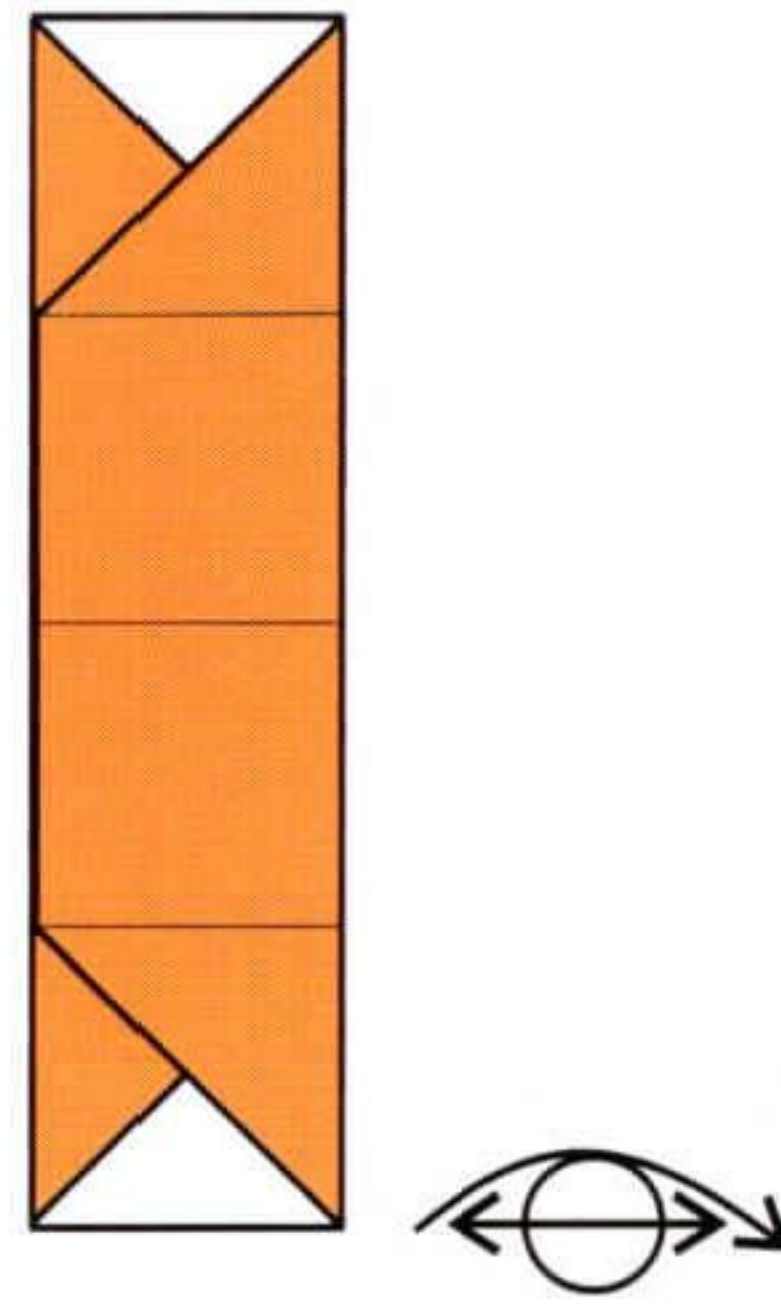

8 Turn the model over left to right.

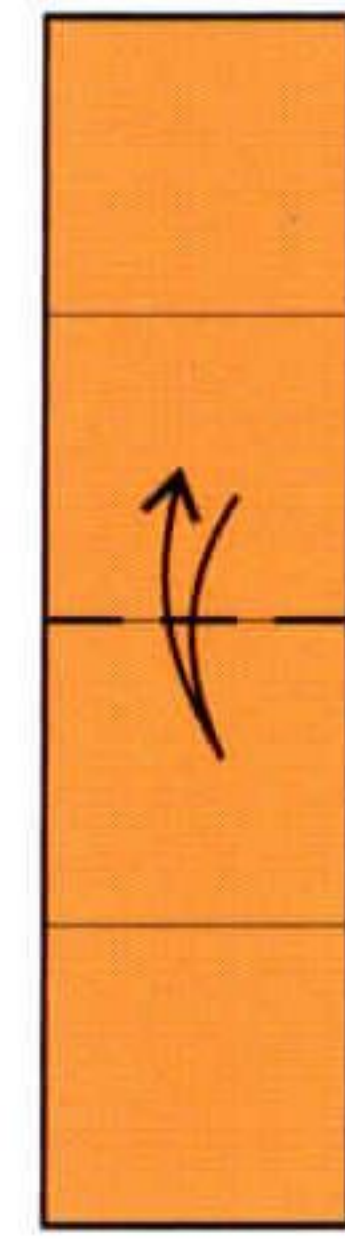

9 Fold and unfold along the middle.

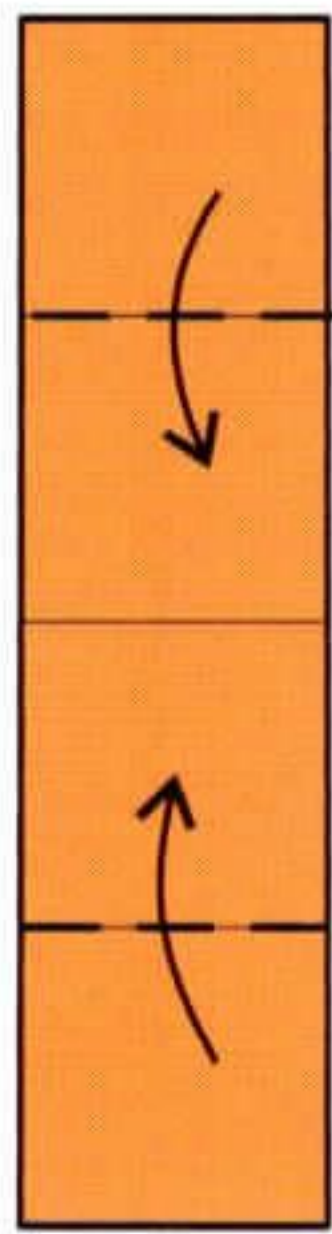

10 Fold the upper and lower edges into the middle.

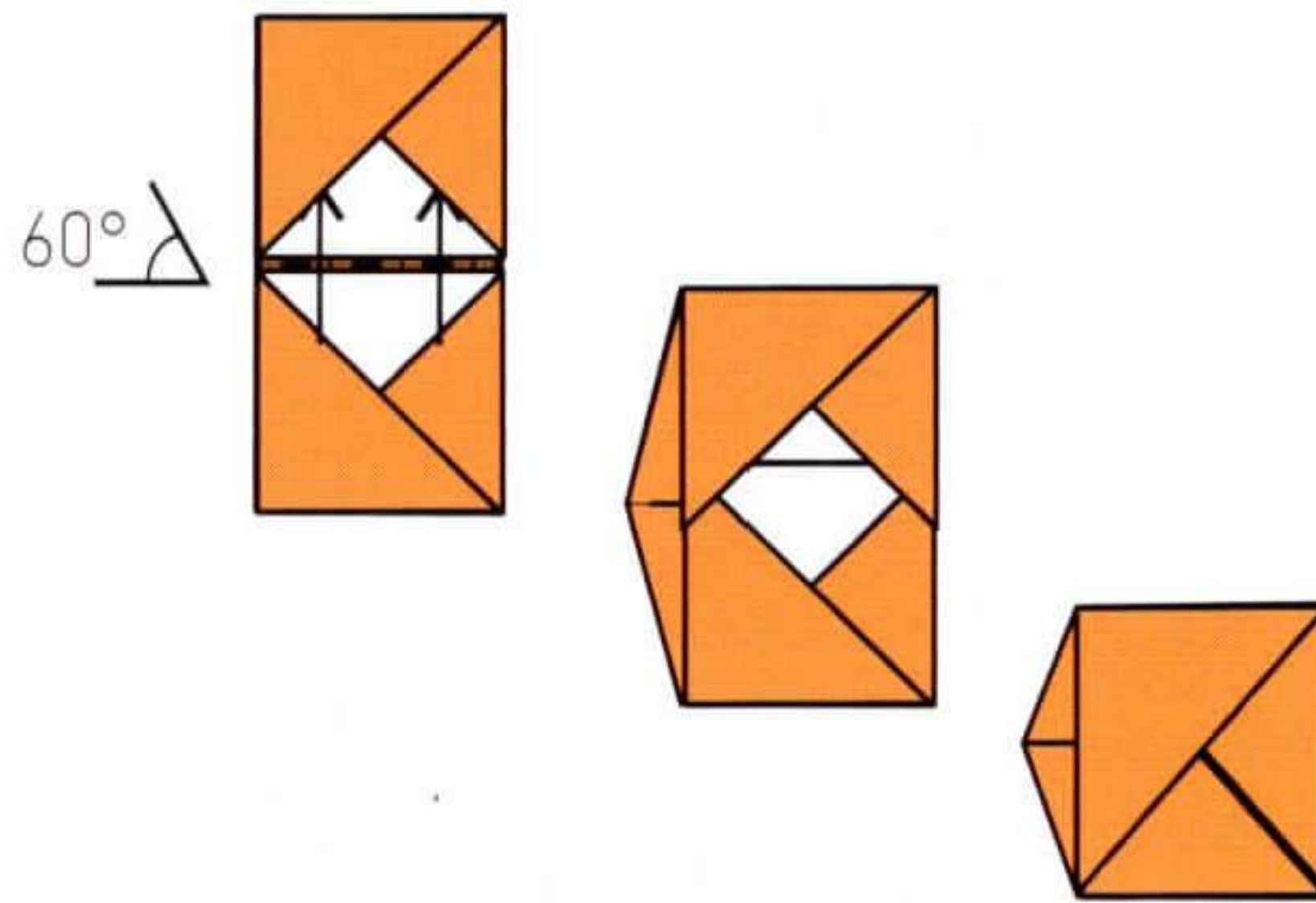

11 Tuck one end into the other. This process shows the two sides sliding into each other.

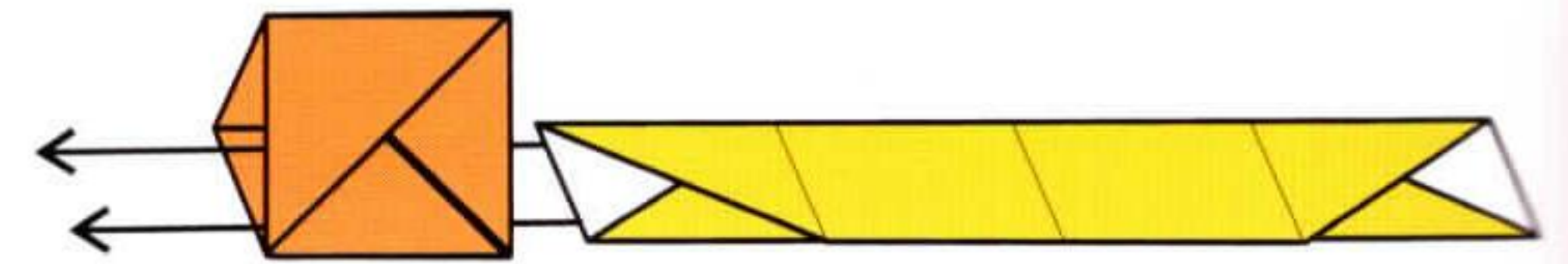

12 Make another module. Unfold it to step 8 and slide the flat version, open side up, into a completed unit.

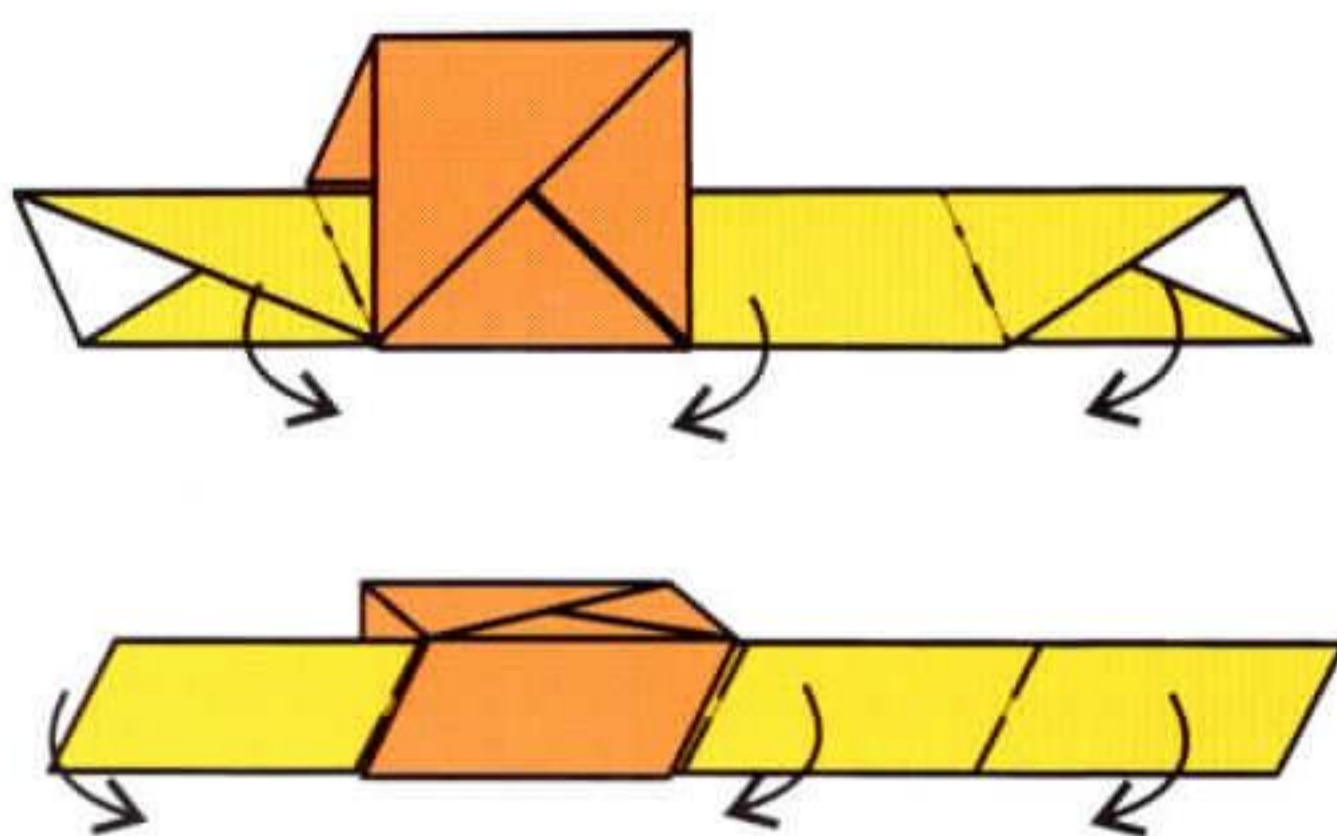

13 Fold the edges of the corners down and slide one end into the other.

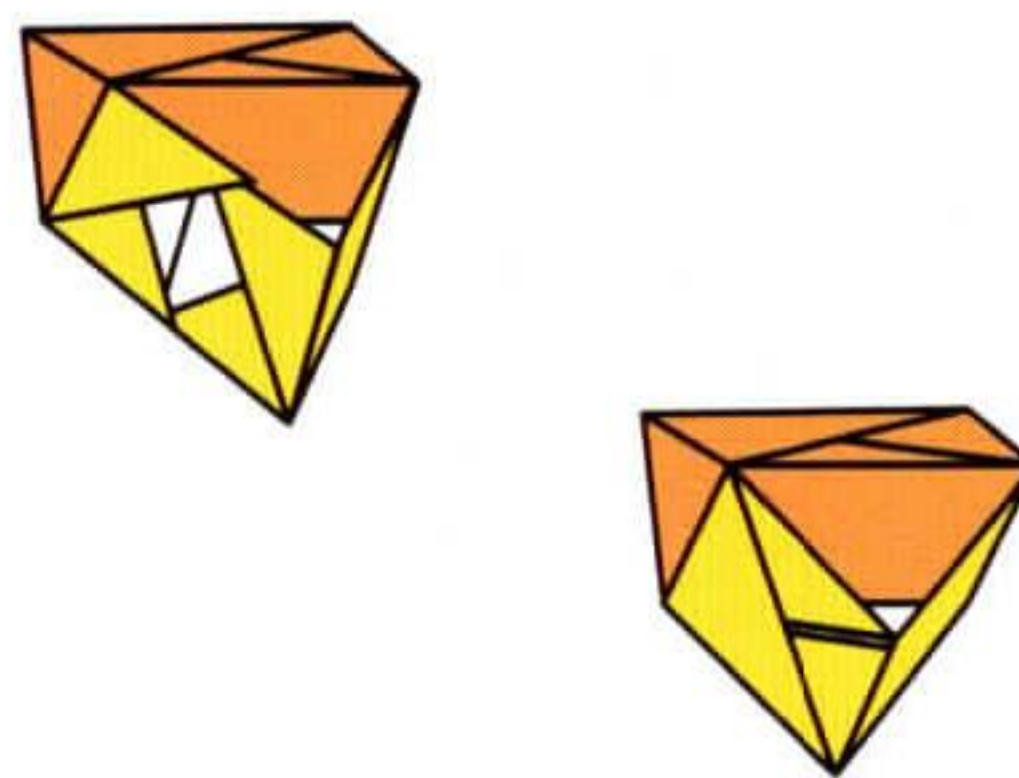

14 Push the two ends together. Add more units to complete the crystal.

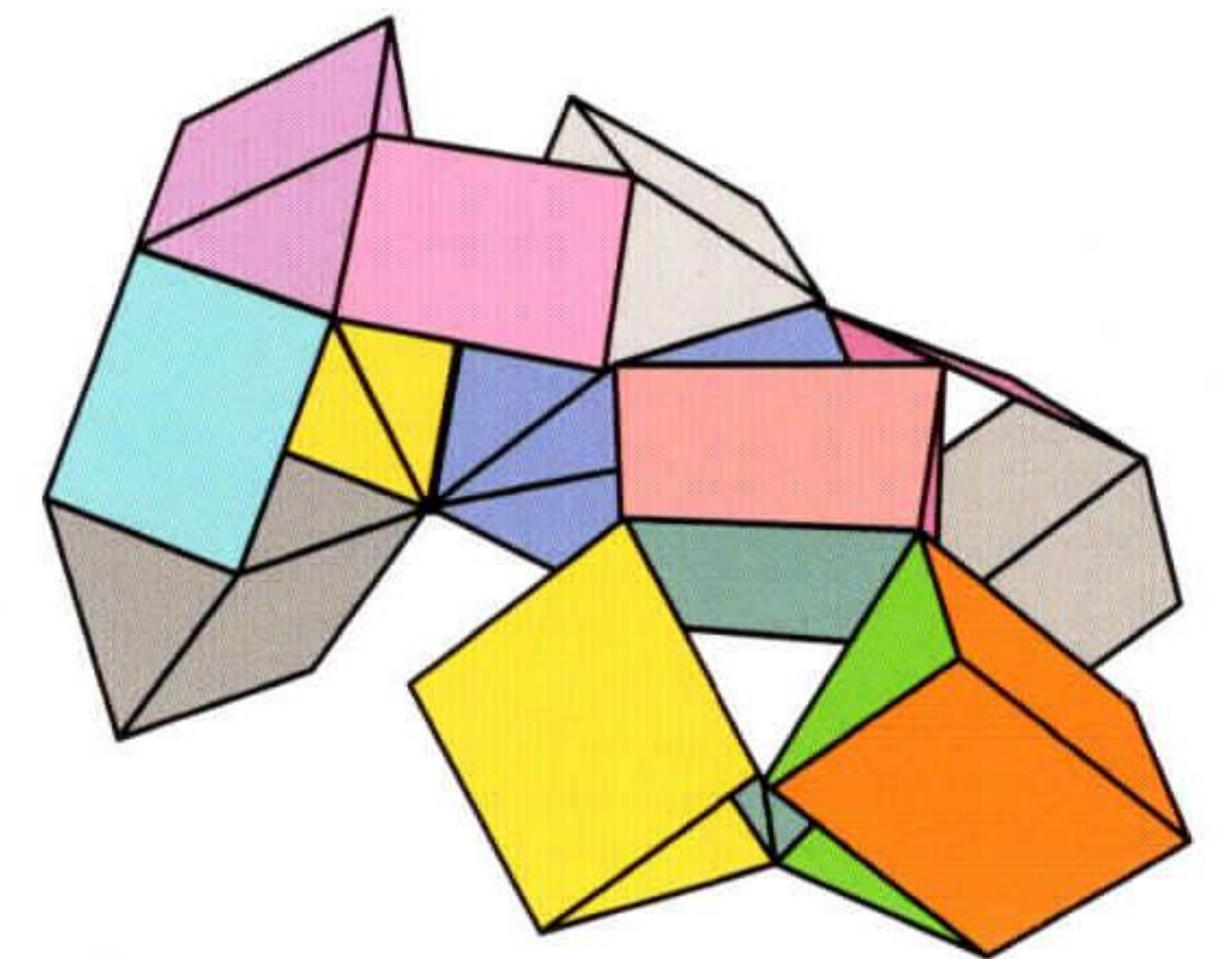

15 Complete.



Octahedron Nolid

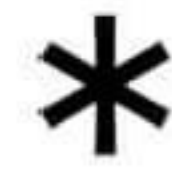

This model is a two-piece assembly. Each unit is made in the same way, with one being rotated to fit into the base of the other.

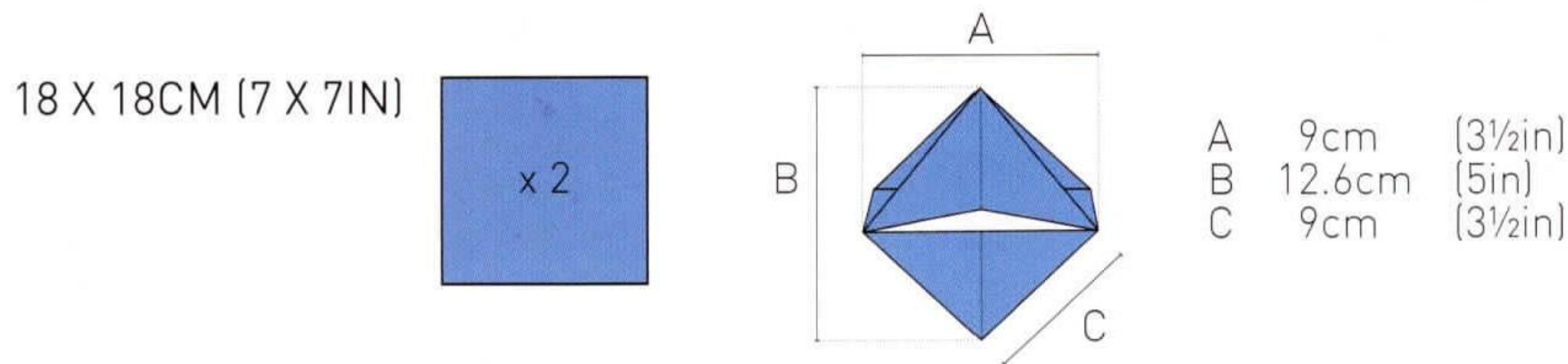

THE MODEL IS MADE FROM TWO SQUARES. FOR EACH UNIT START WITH A SQUARE, COLOURED SIDE UP.

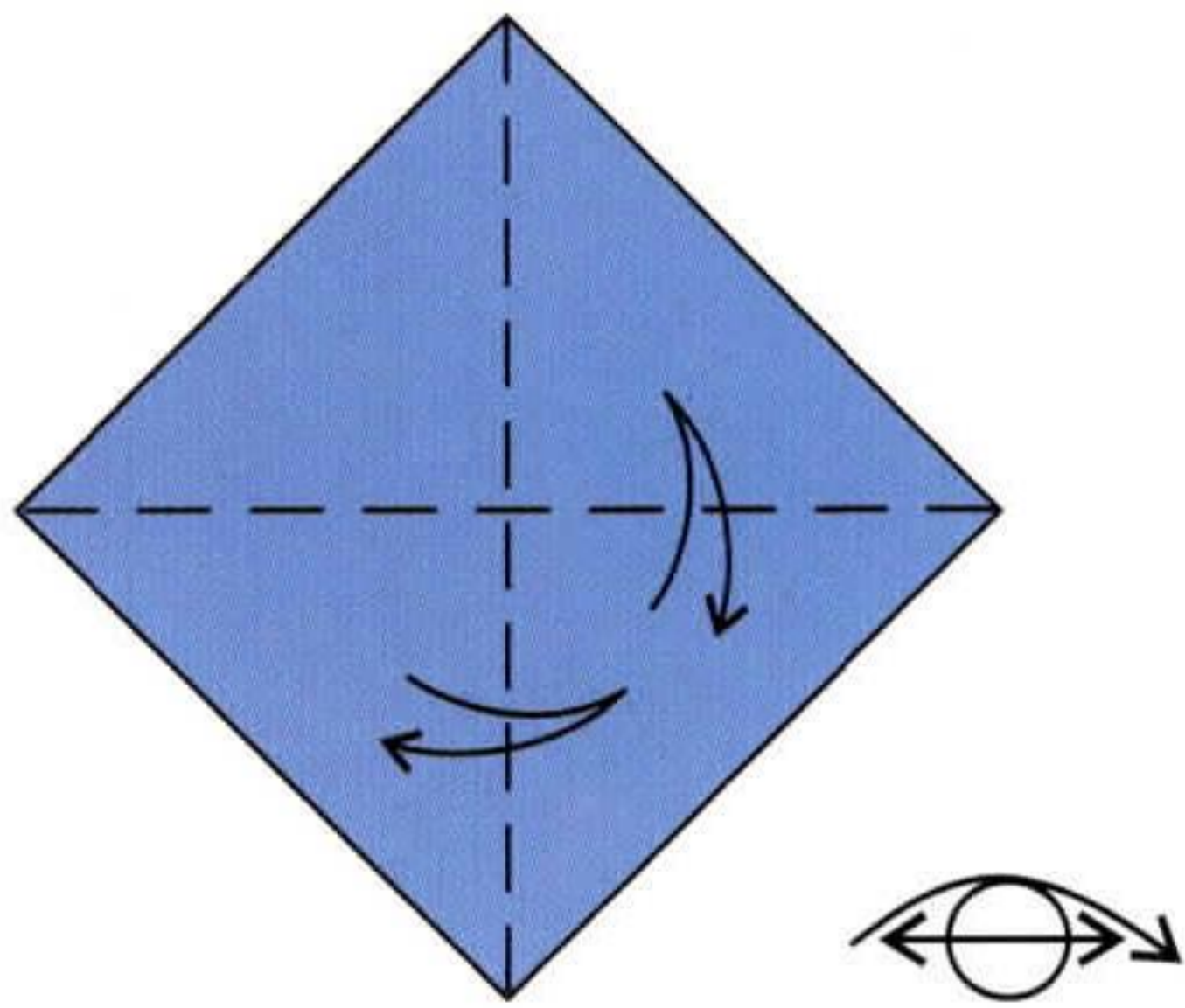

1 Fold and unfold the square in half diagonally along both axes. Then turn the paper over left to right.

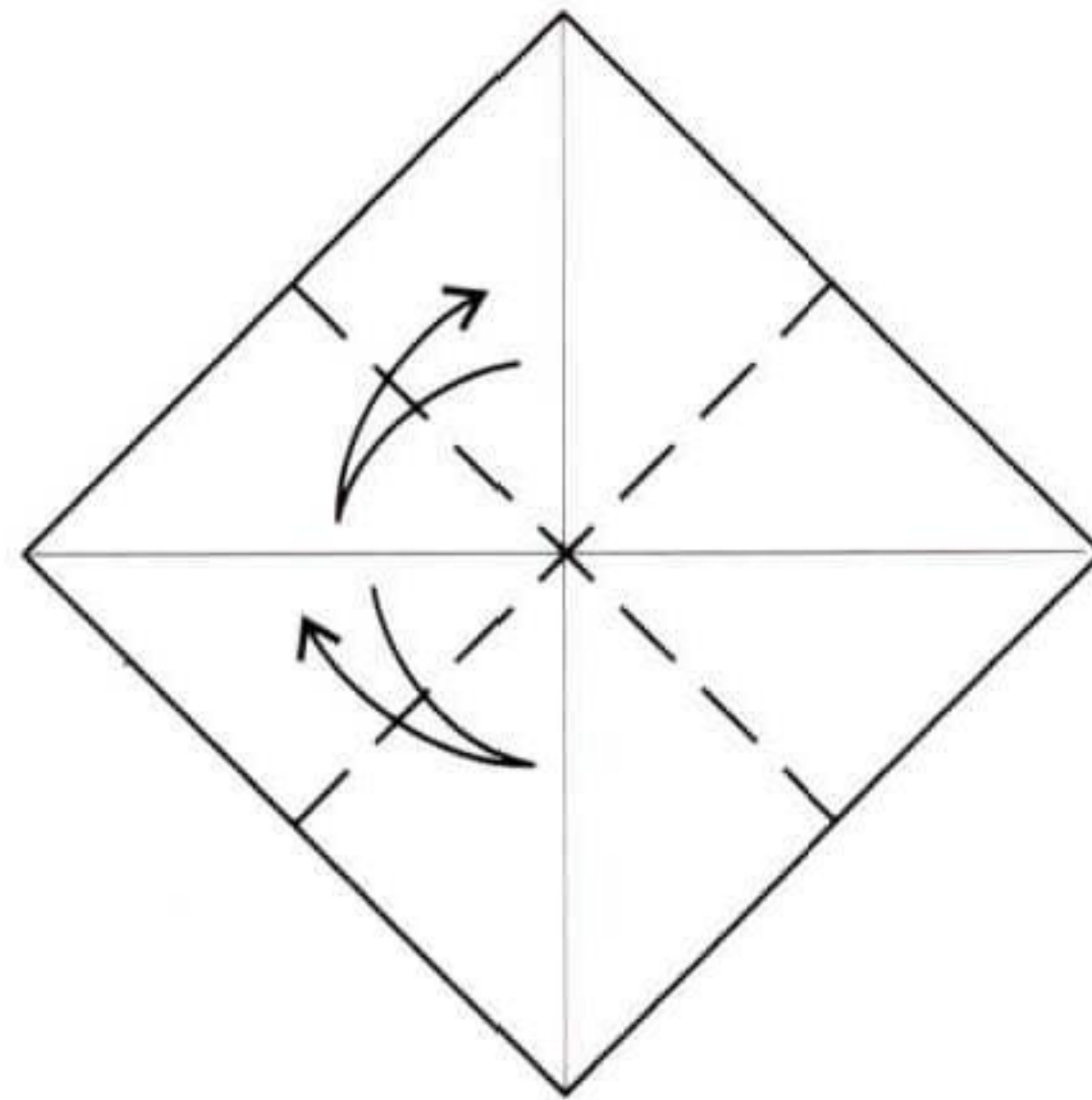

2 Fold and unfold the square in half lengthwise.

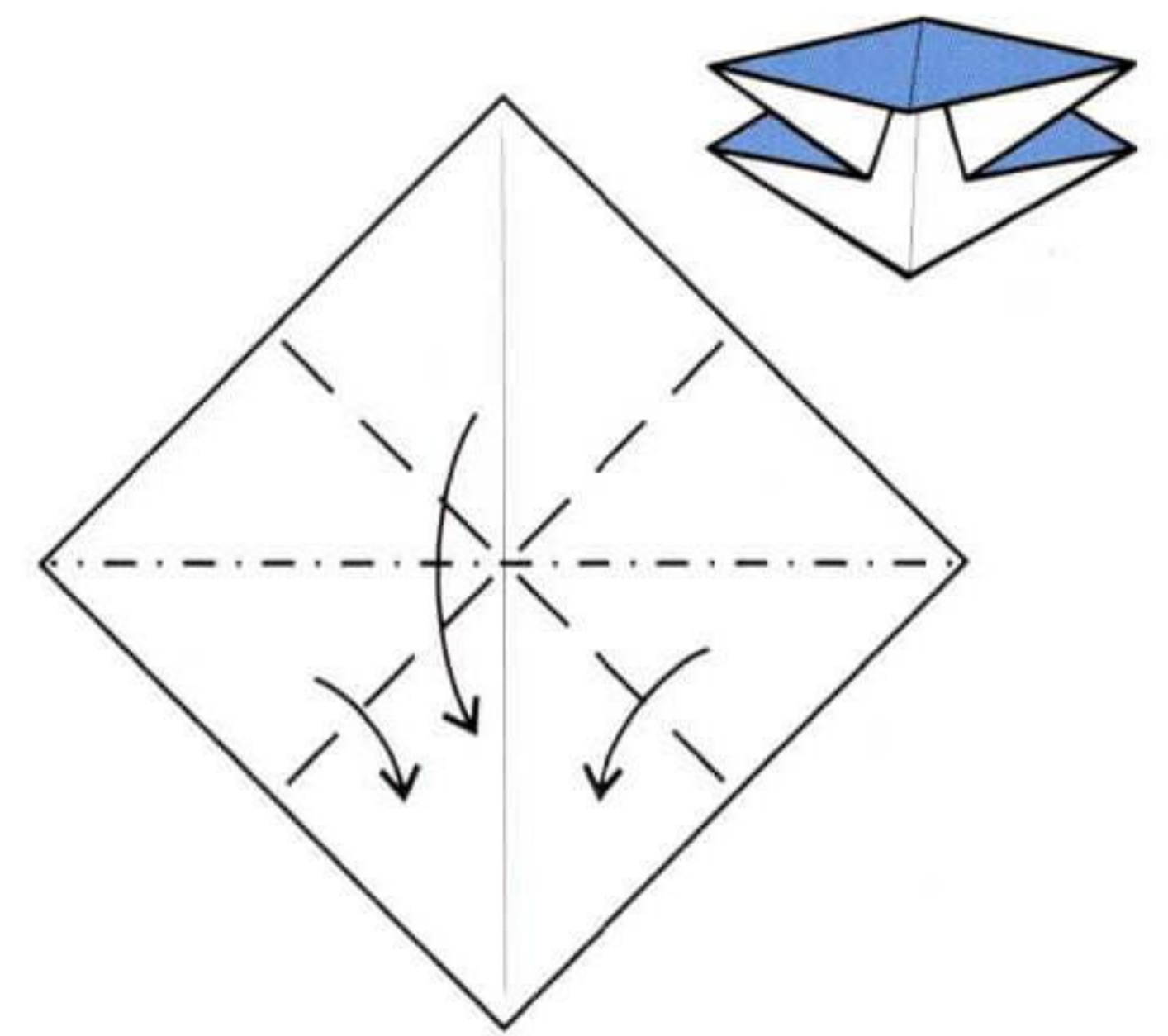

3 Fold the upper half down. At the same time fold in the sides to make a preliminary base.

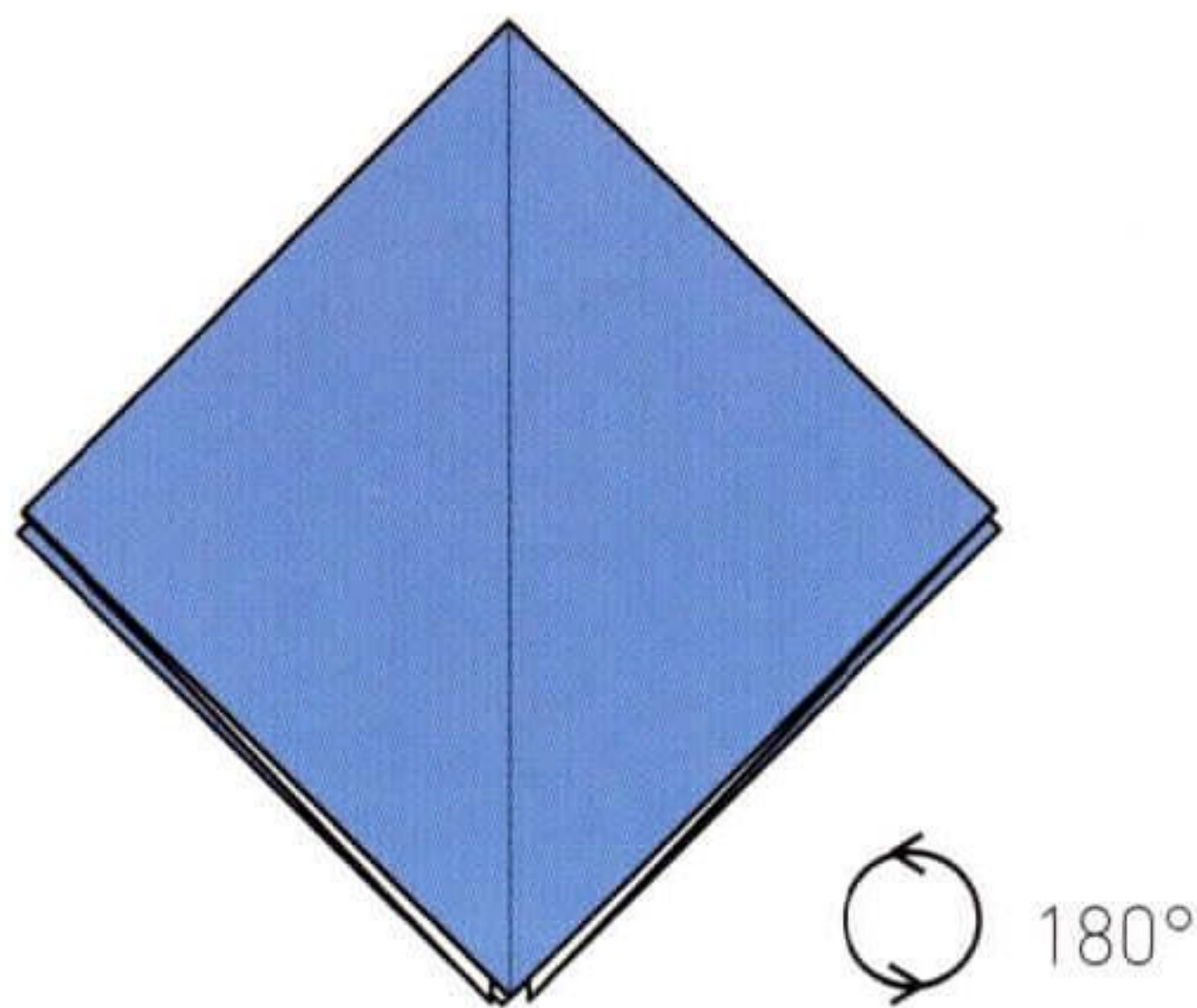

4 Rotate the model by 180°.

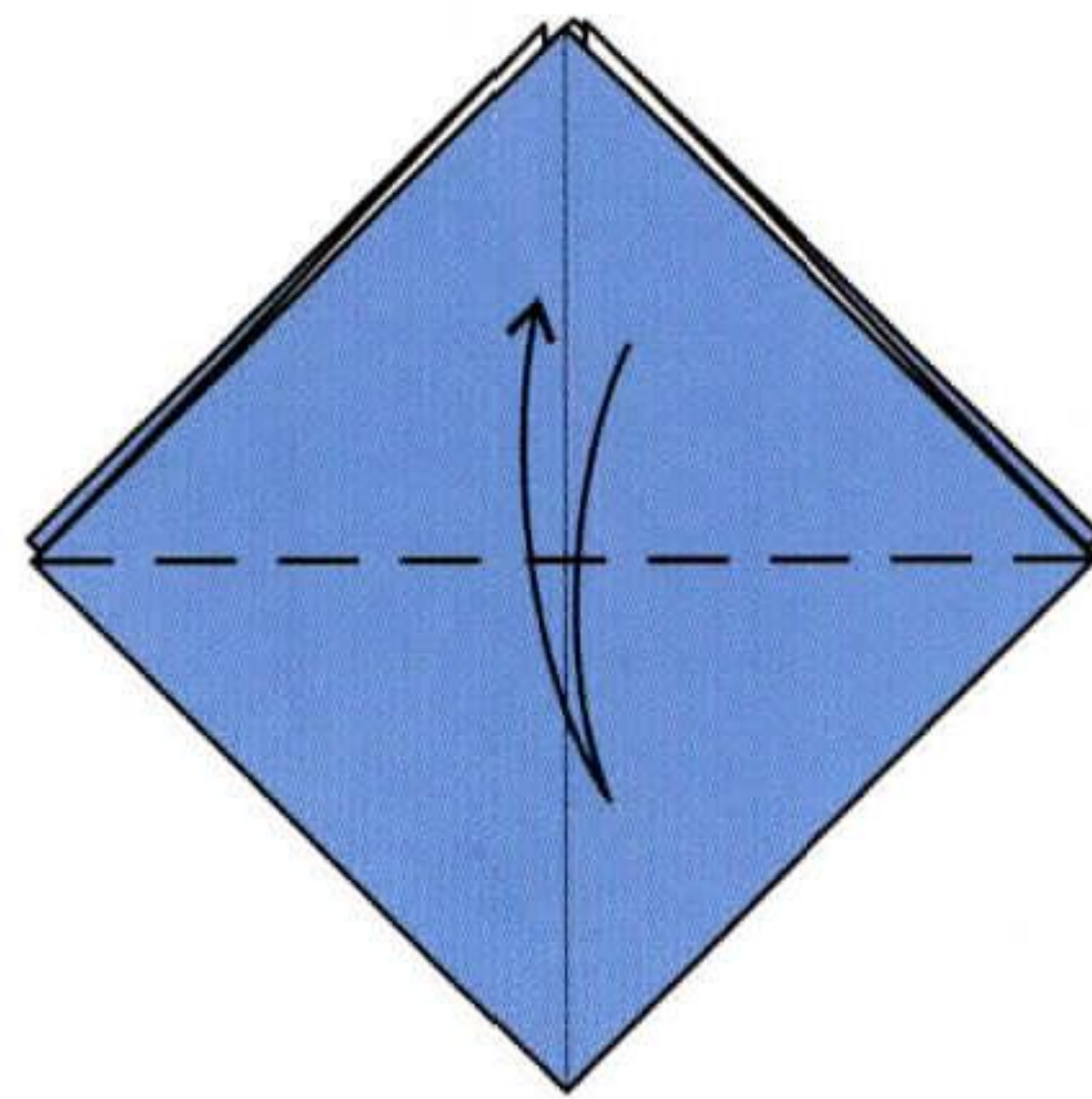

5 Fold and unfold the front layer along the middle.

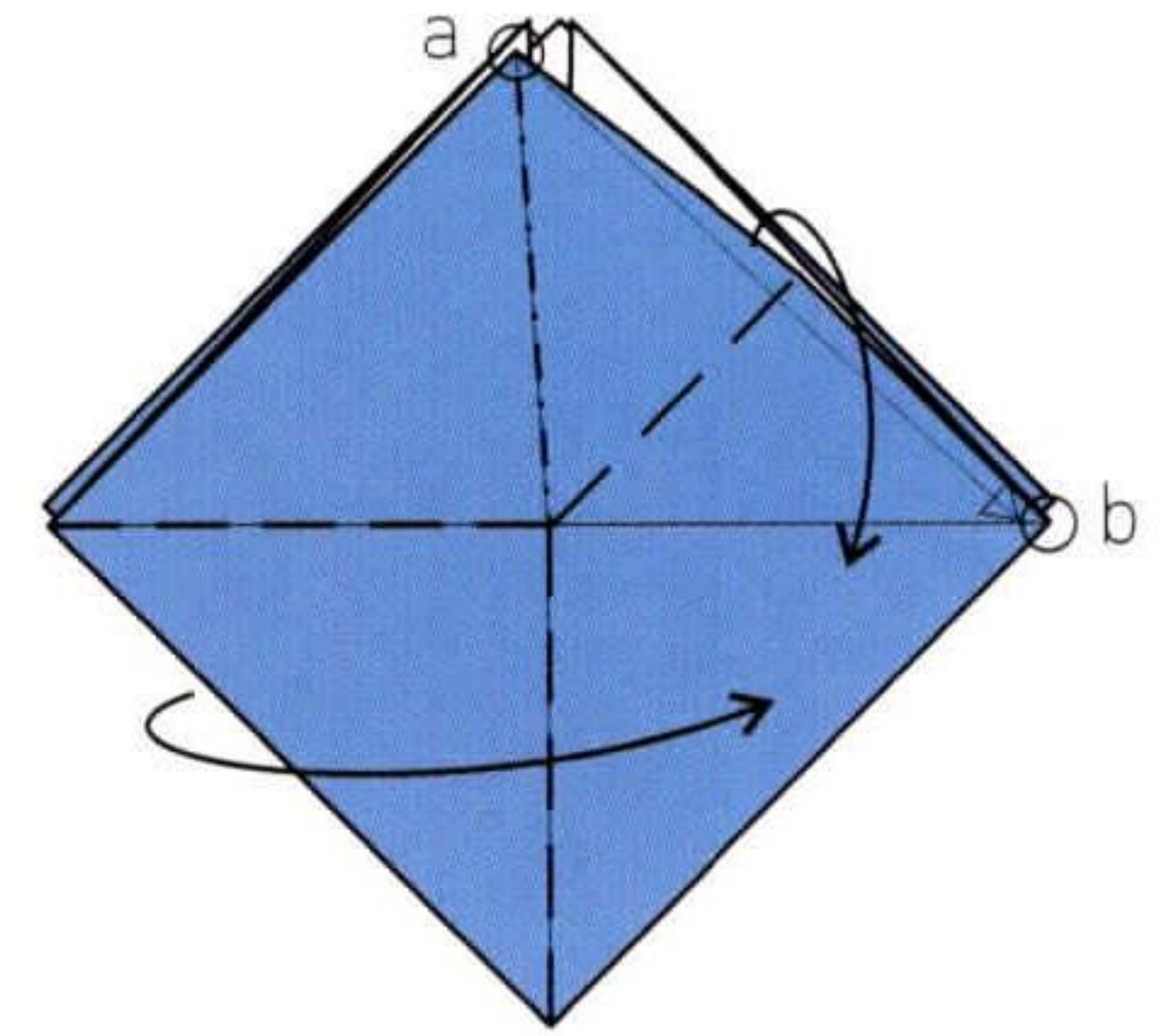

6 Fold the left side to the right to be perpendicular to the rear section. At the same time fold down the upper section causing (a) to touch (b).

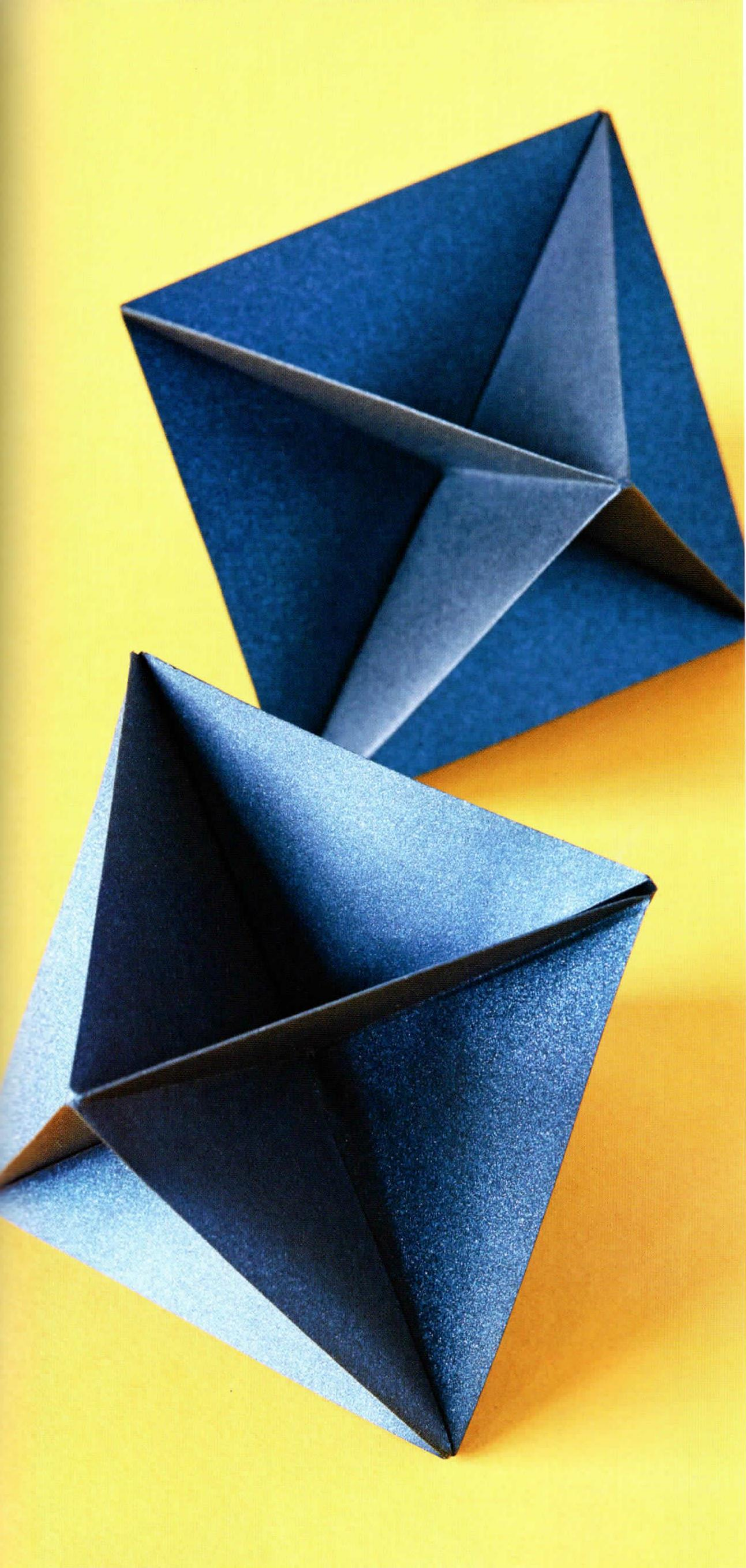

JOINING TWO UNITS TO FORM A NOLID

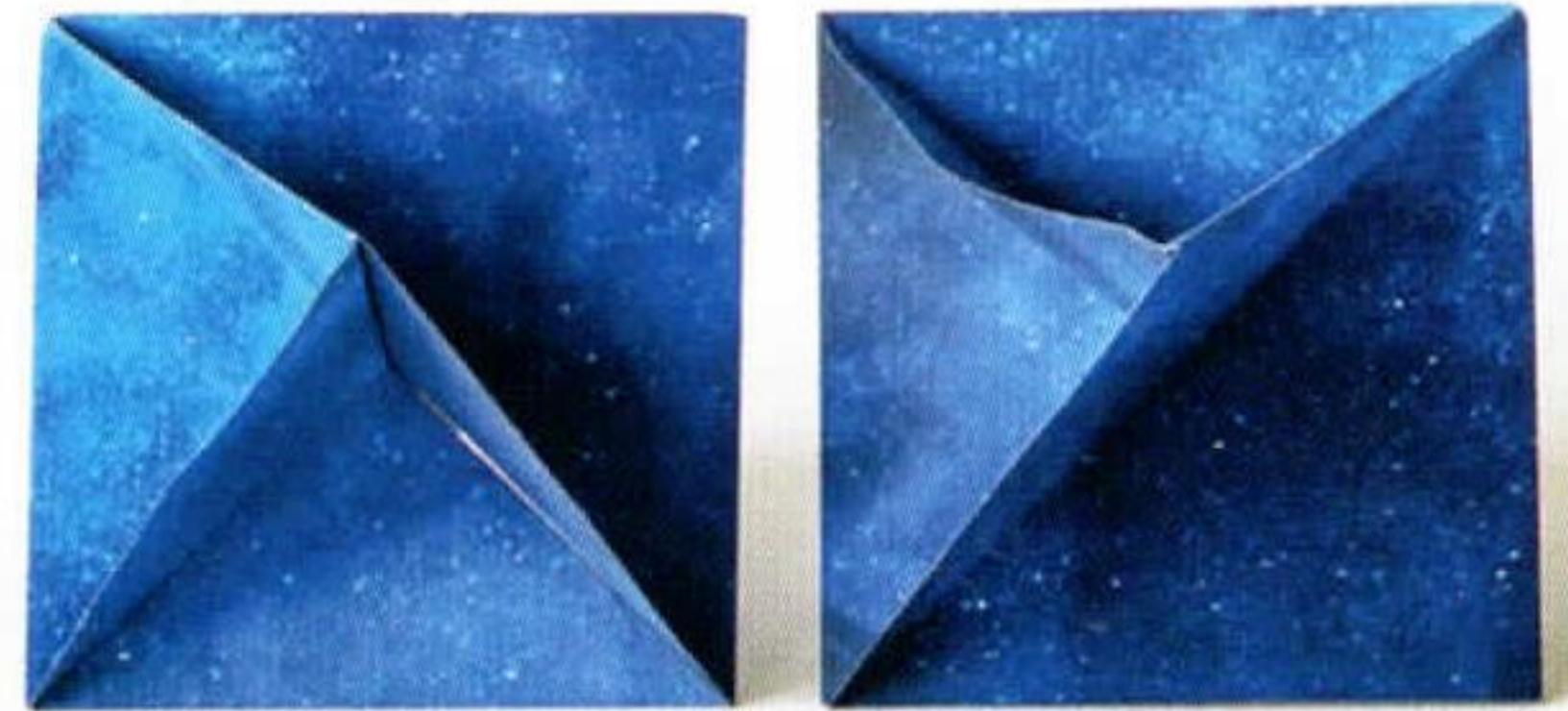

1

Two similar units.

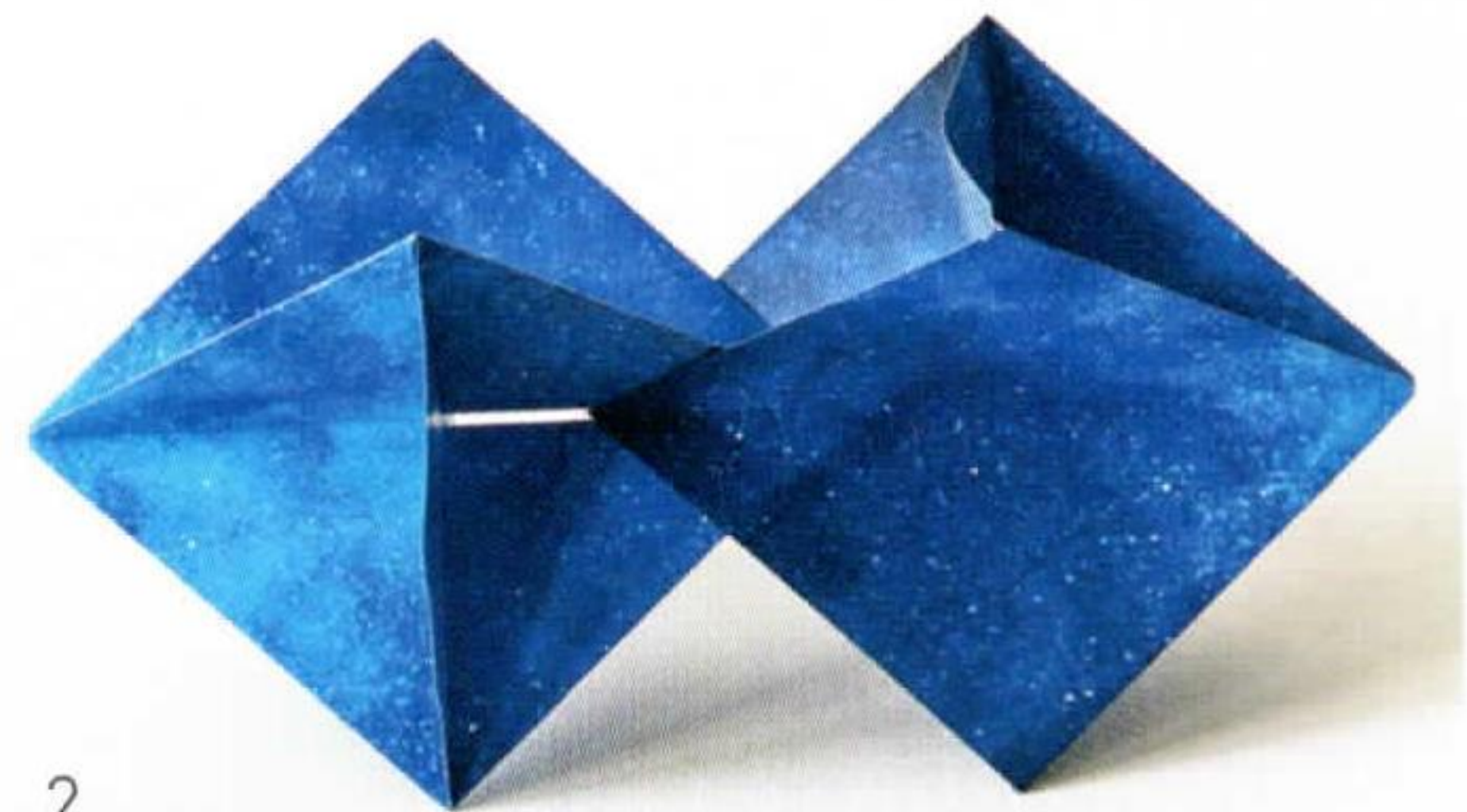

2

Align the points on one unit with the base of the other and insert.

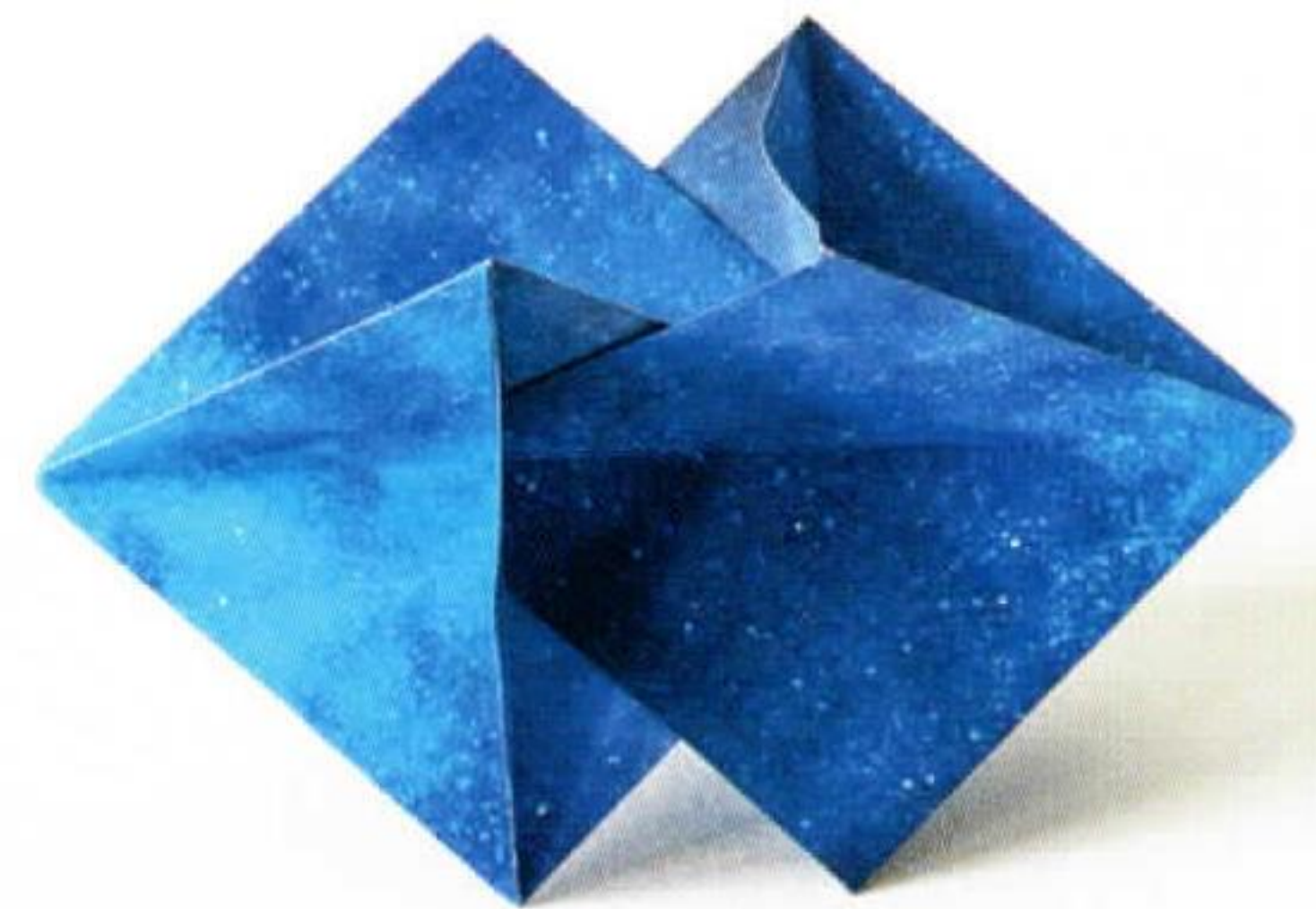

3

Slide the two units together.

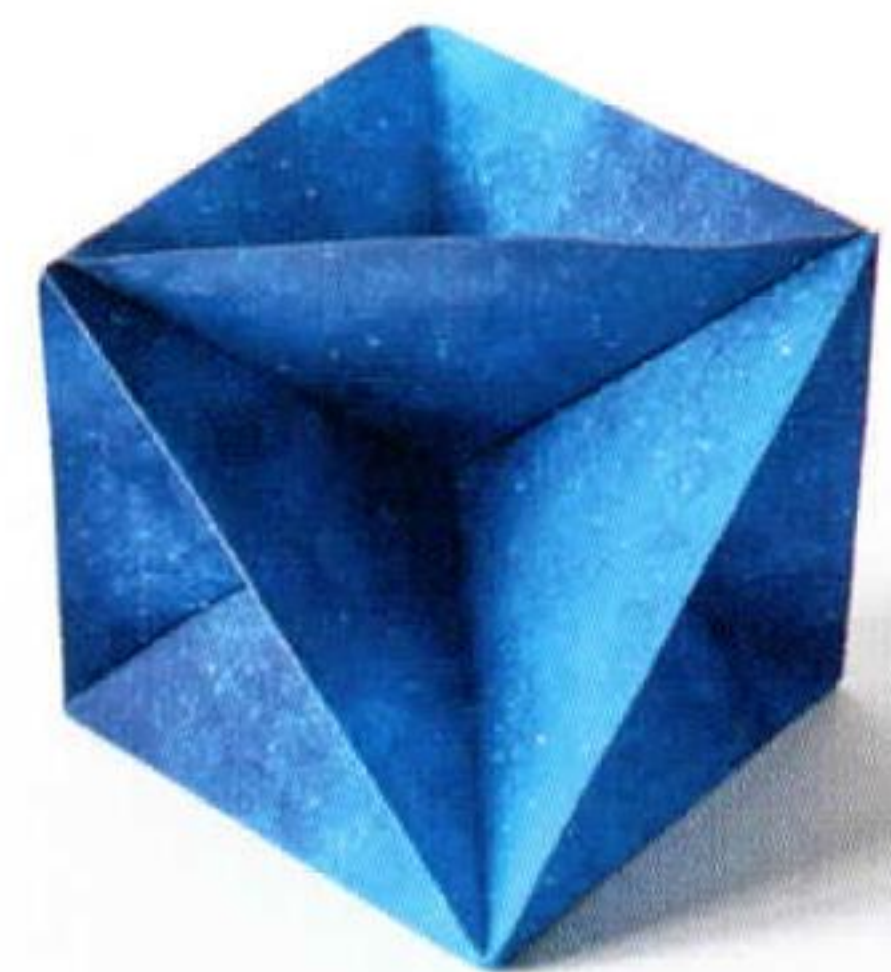

4

Model complete.

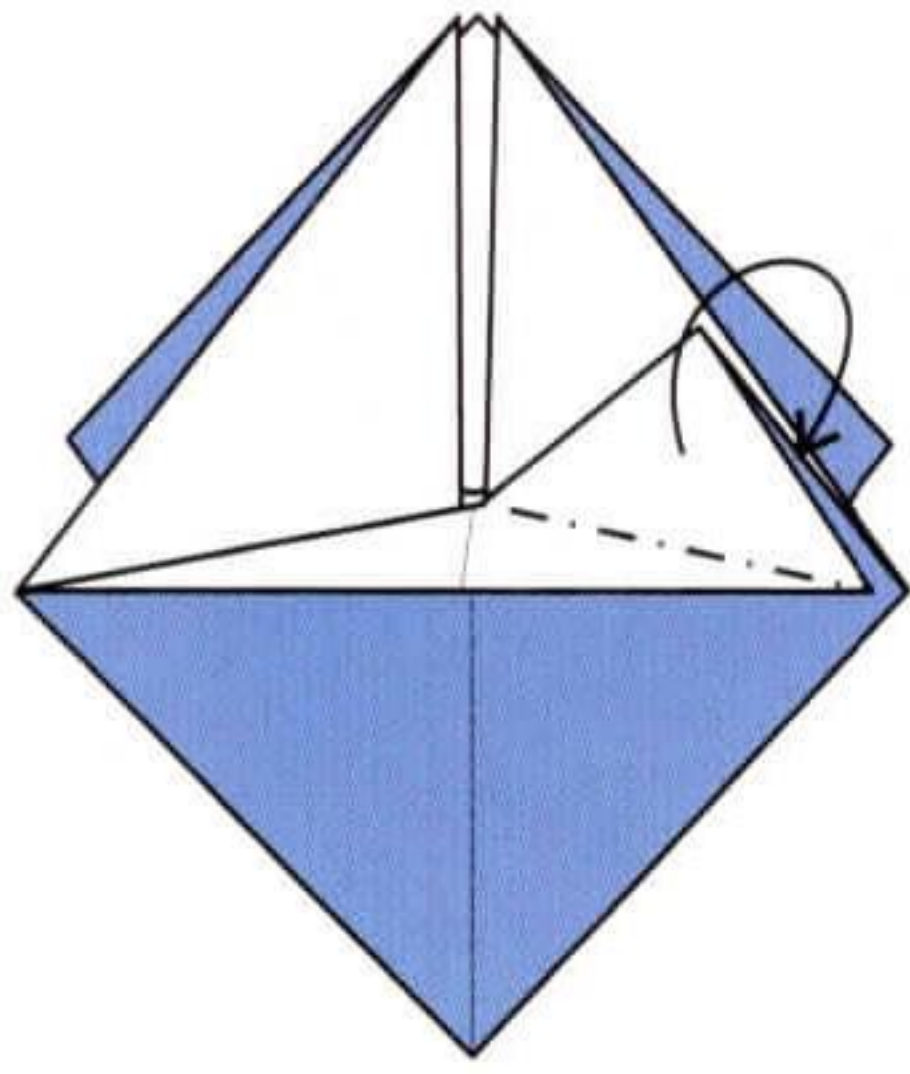

7 Fold the corner behind and into the pocket behind.

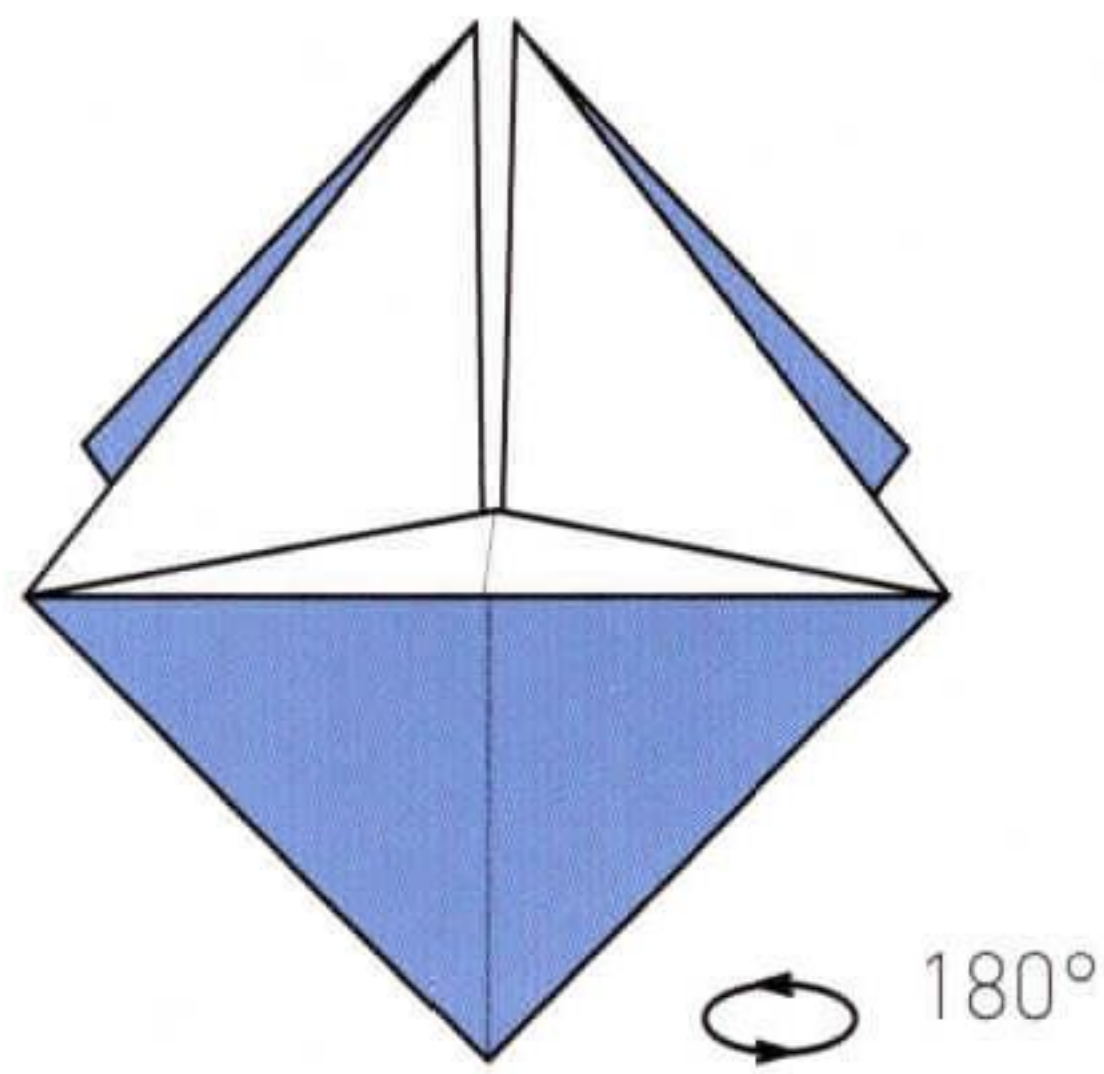

8 Rotate the unit by 180° to work on the reverse.

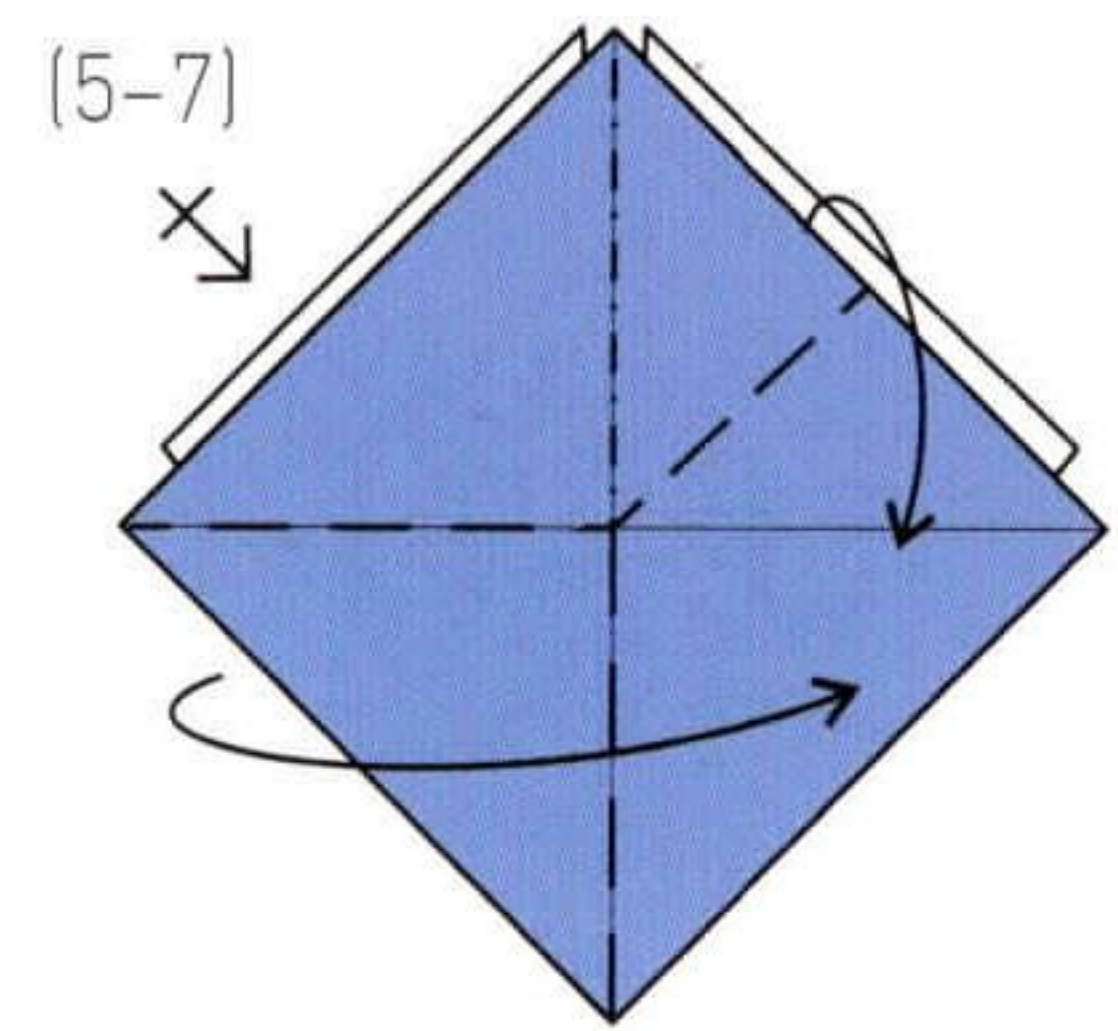

9 Repeat steps 5 to 7.

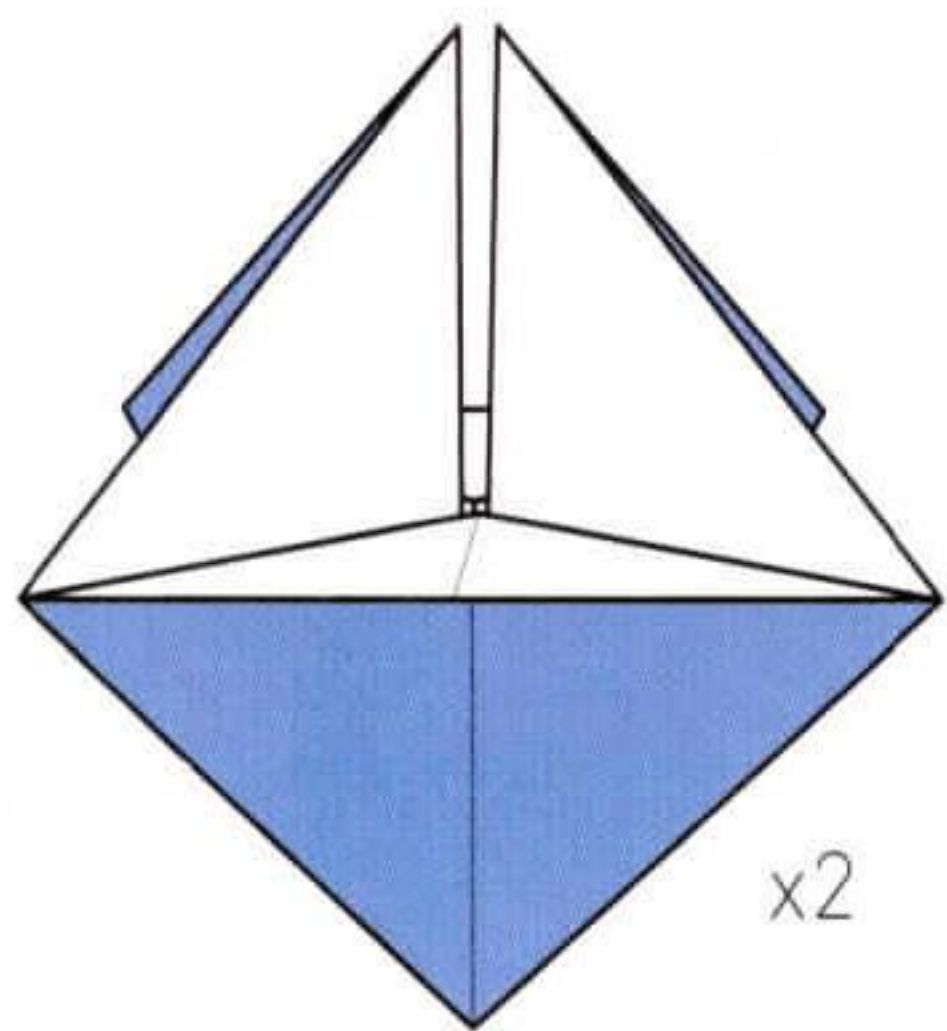

10 One unit is complete. Make a second in the same way to complete the model.

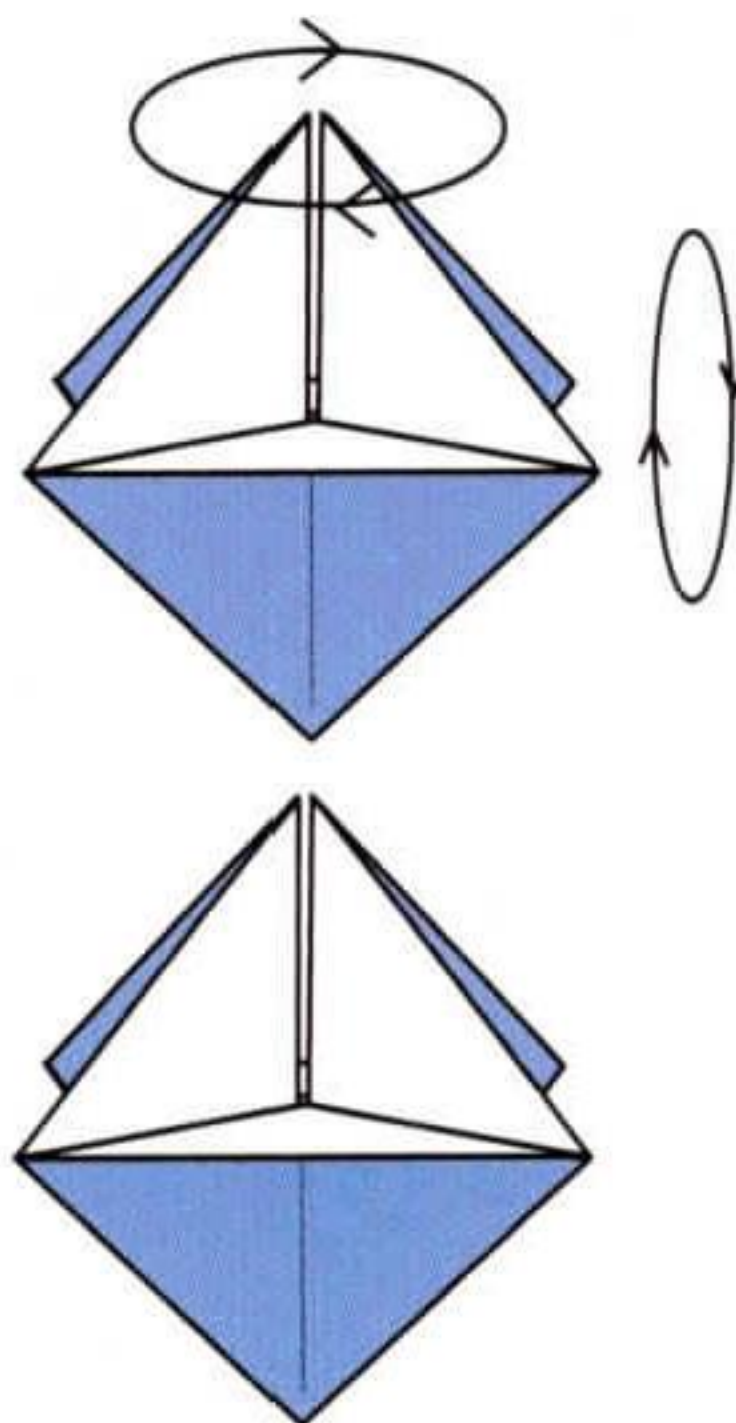

11 The two units should be the same. Turn one unit upside down and rotate it by 90°.

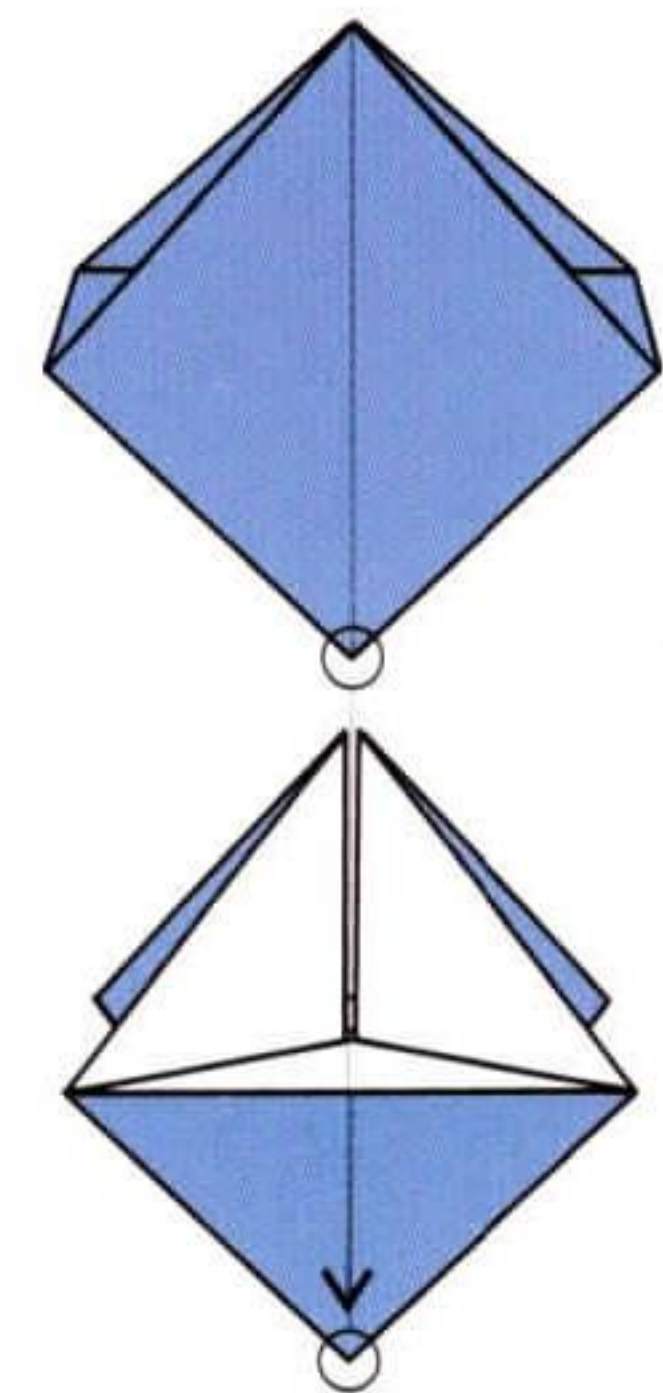

12 Line up the two units and insert one into the other (see previous page right).

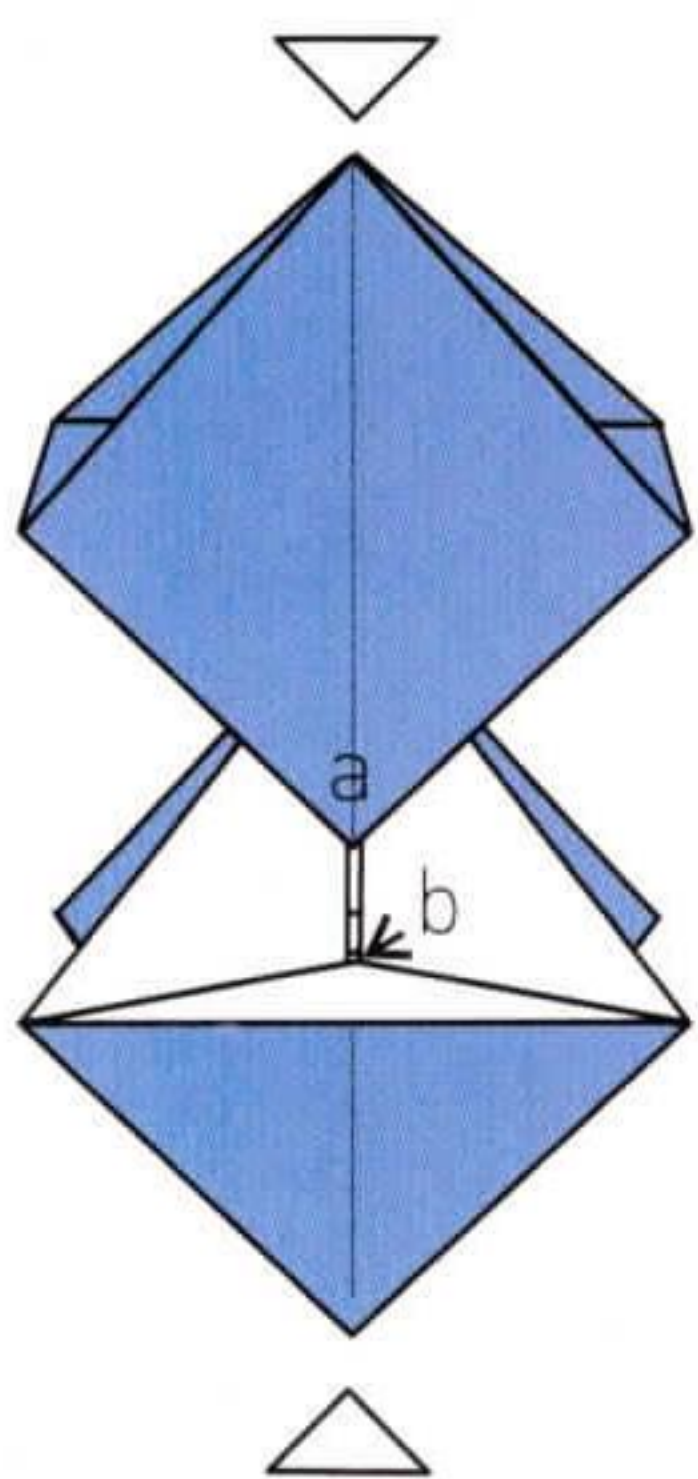

13 First line up the points and tuck the corner (a) beneath the edge (b), front and back. Then slide one unit into the other.

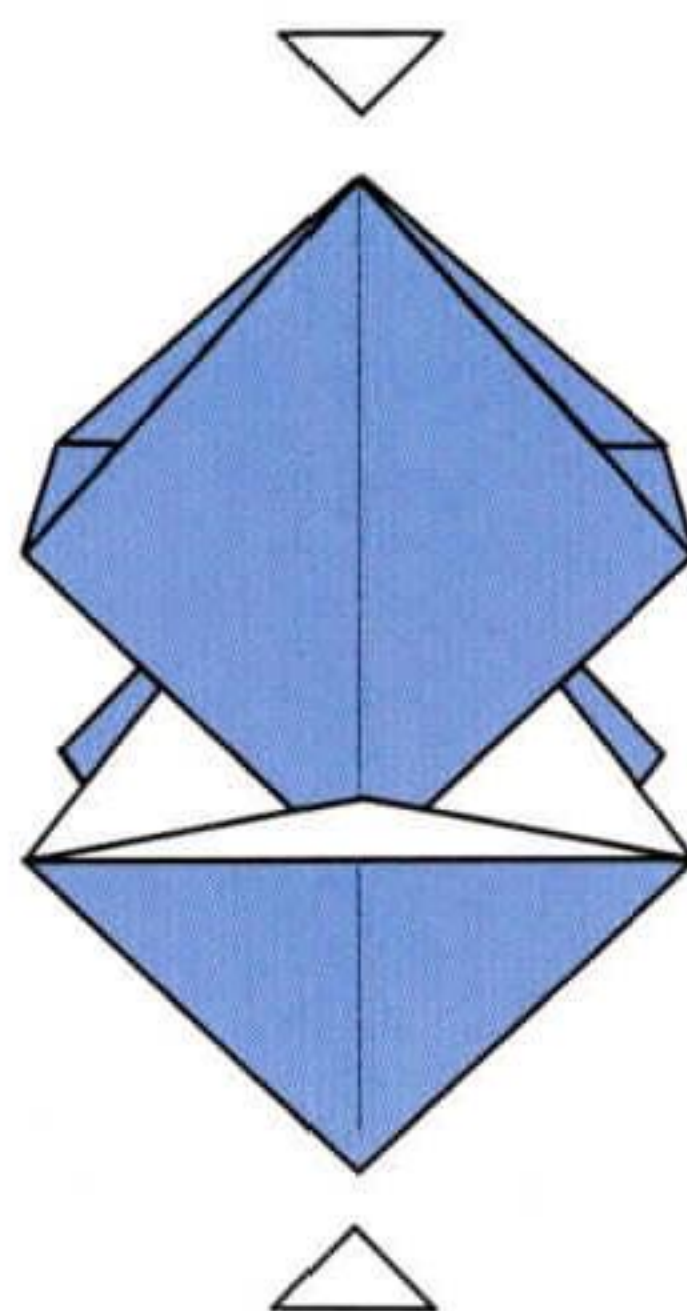

14 Continue pushing the units together.

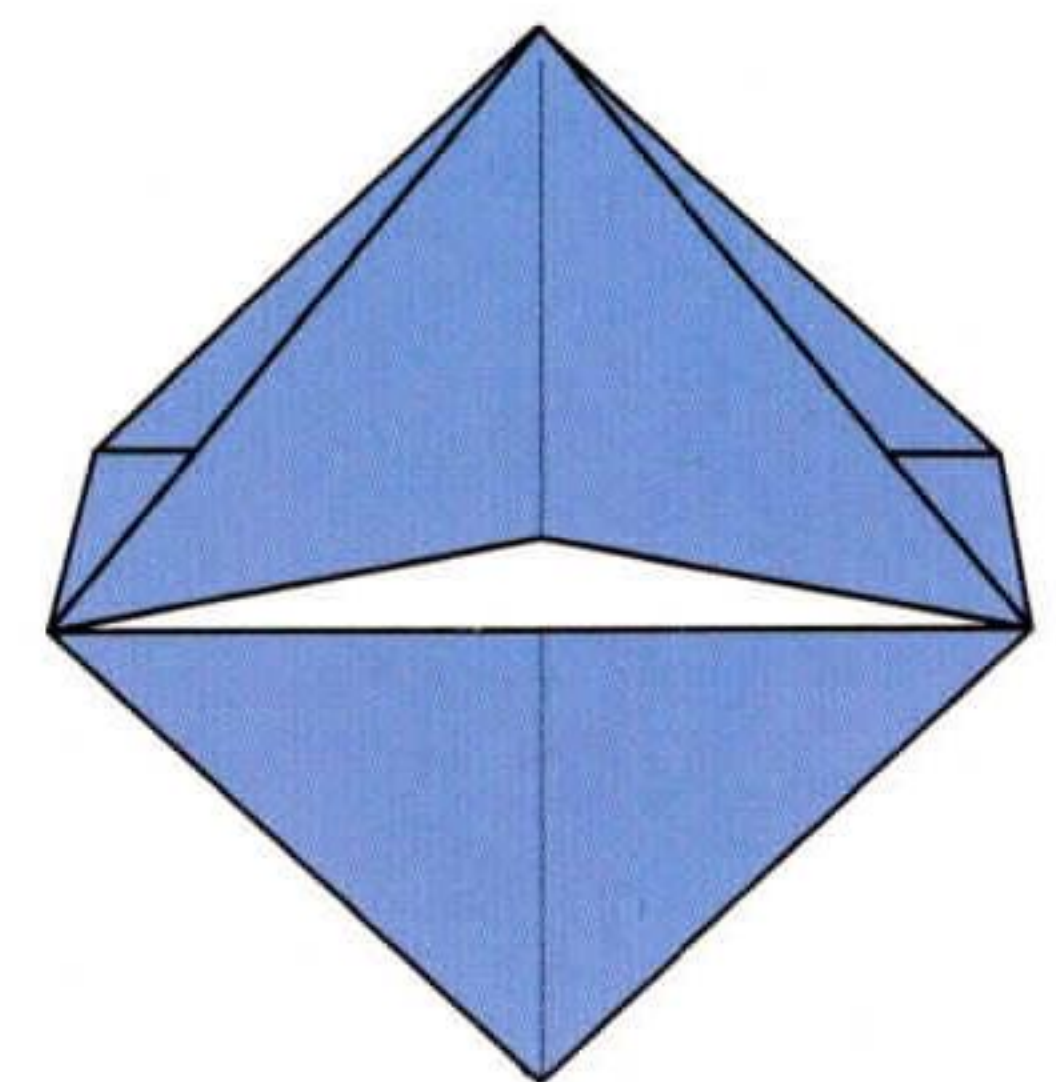

15 Complete.

Dodecahedron

**

The Dodecahedron is one of the platonic solids constructed from twelve regular pentagons. In ancient Greece its shape was seen as fundamental to the arrangement of the universe.

18 X 18CM (7 X 7IN)

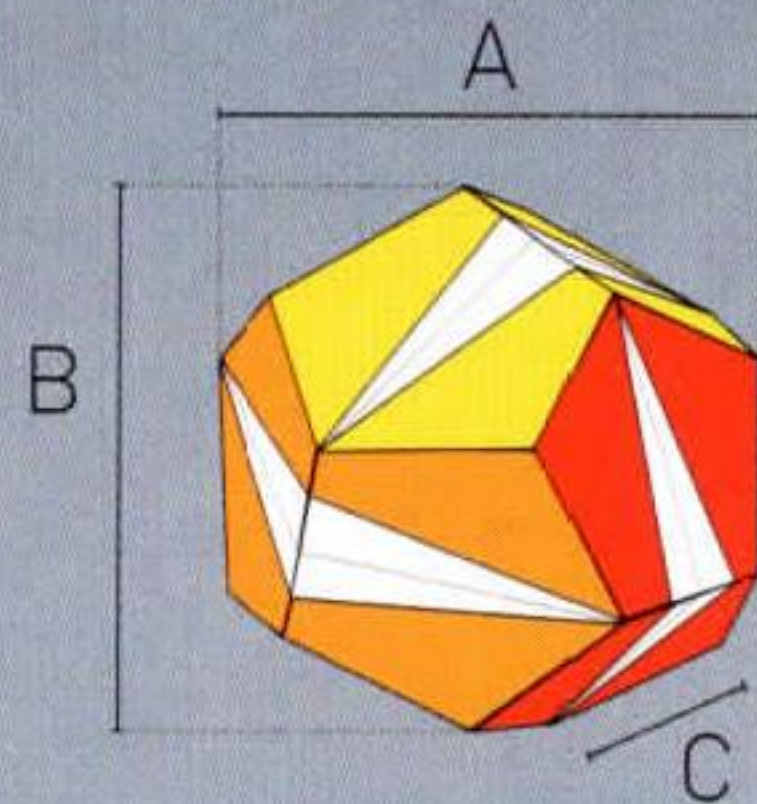
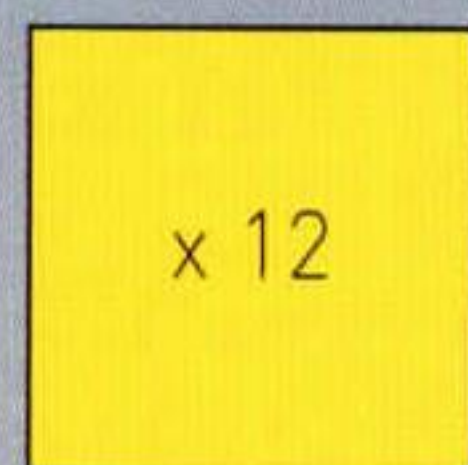

A	14.4cm	(5½in)
B	14.4cm	(5½in)
C	14.4cm	(5½in)

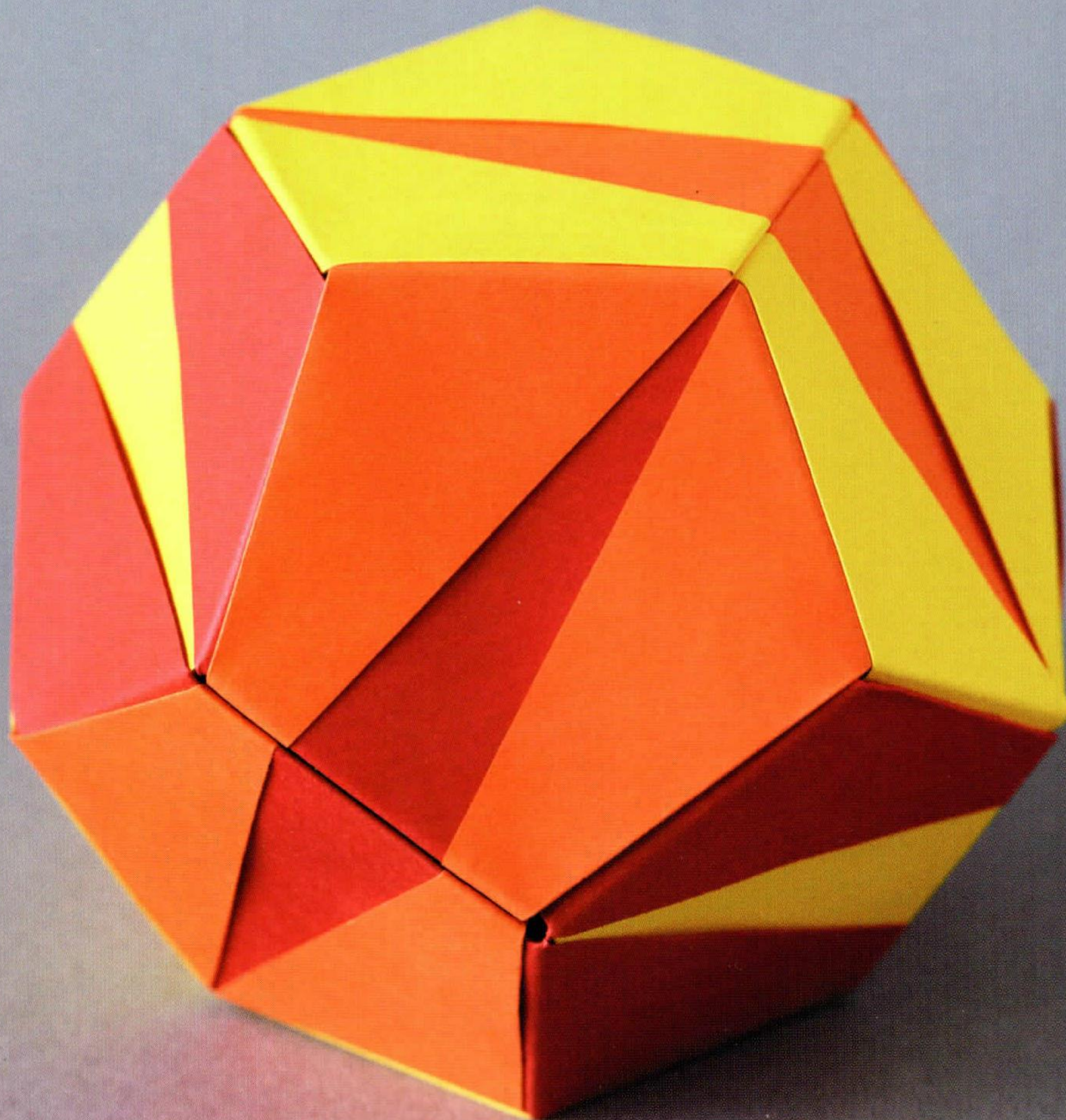

THE MODEL IS MADE FROM 12 UNITS. FOR EACH UNIT START WITH A SQUARE, COLOURED SIDE UP.

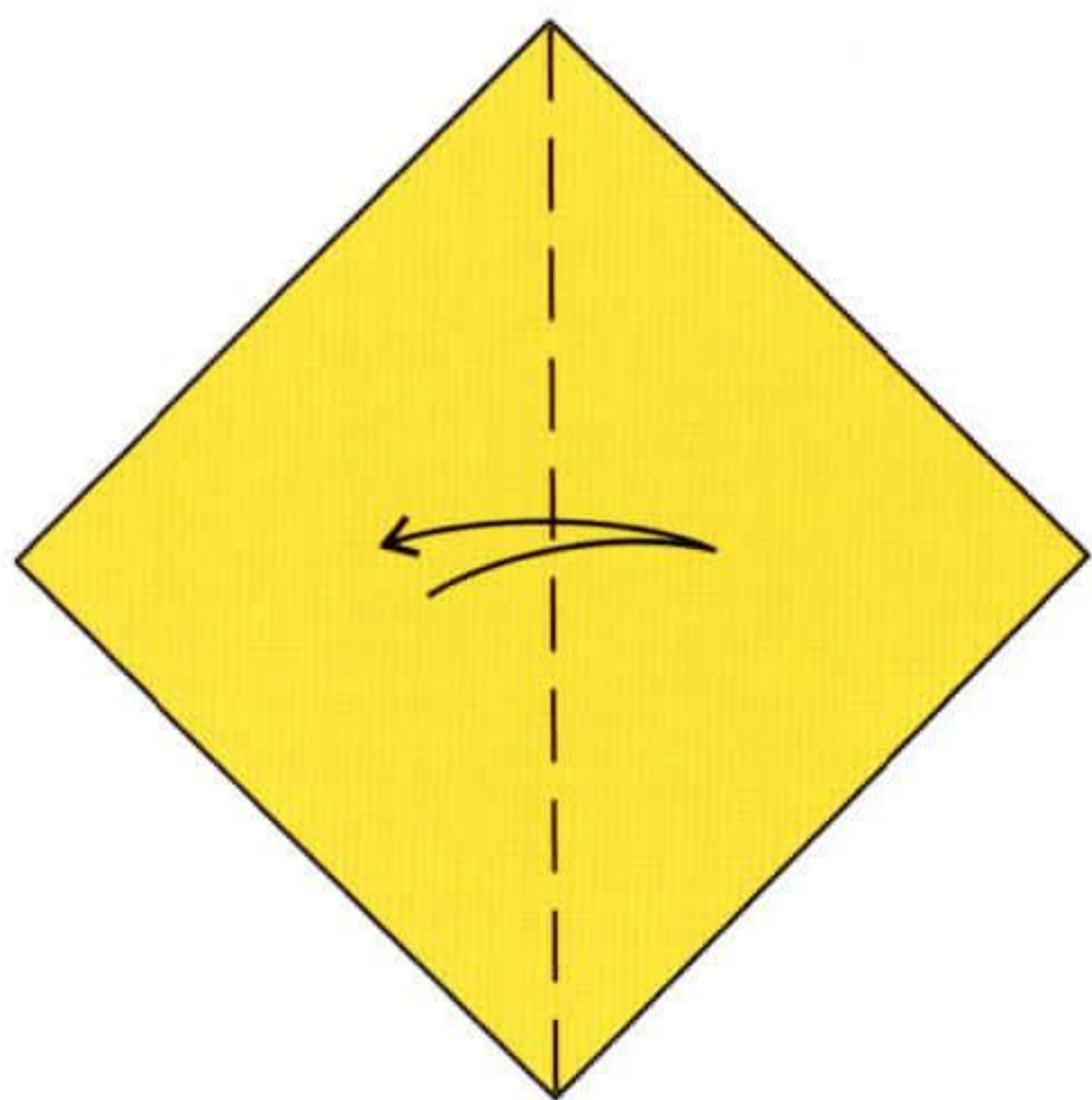

1 Fold and unfold the square in half lengthwise.

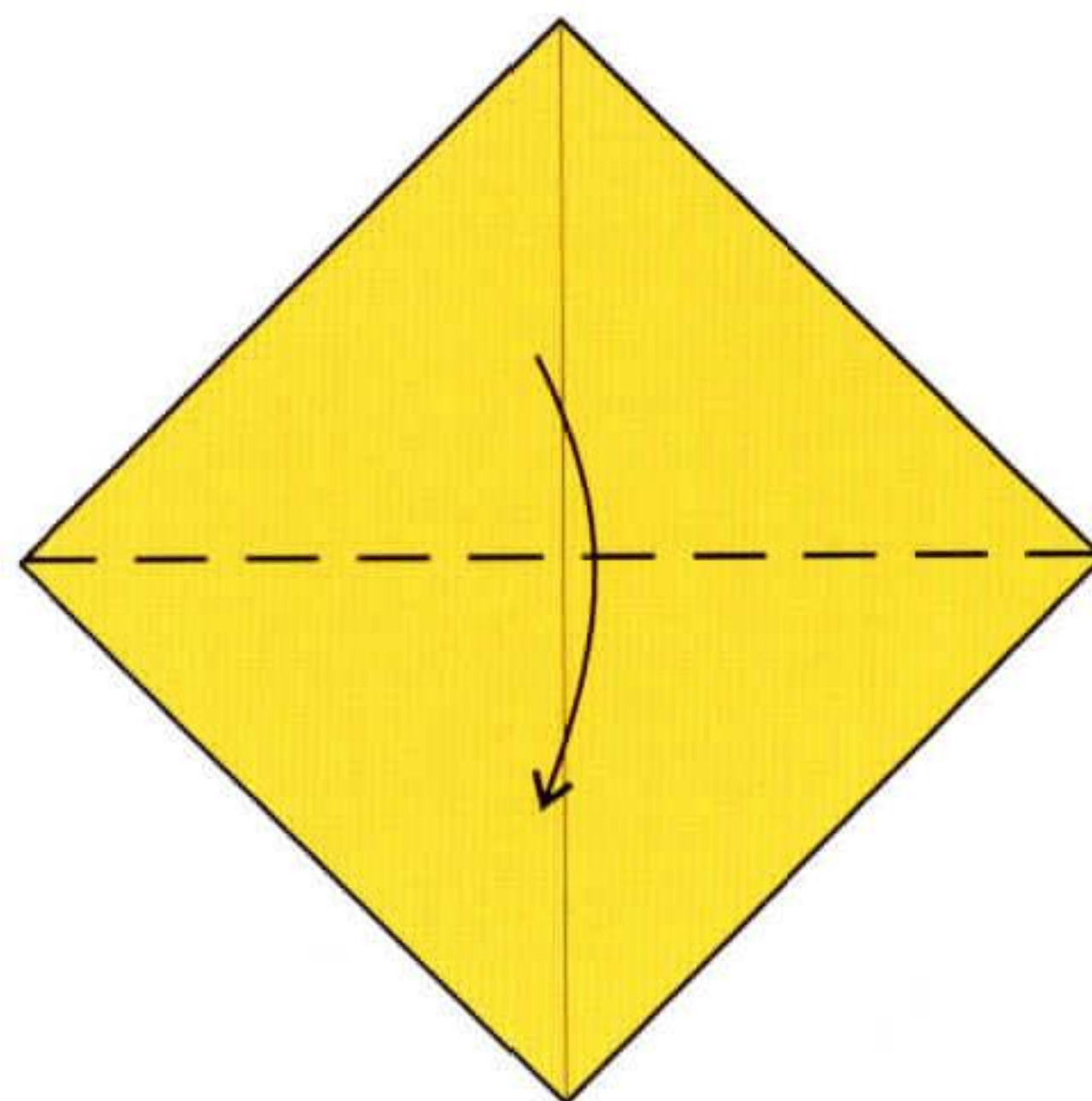

2 Fold the square in half.

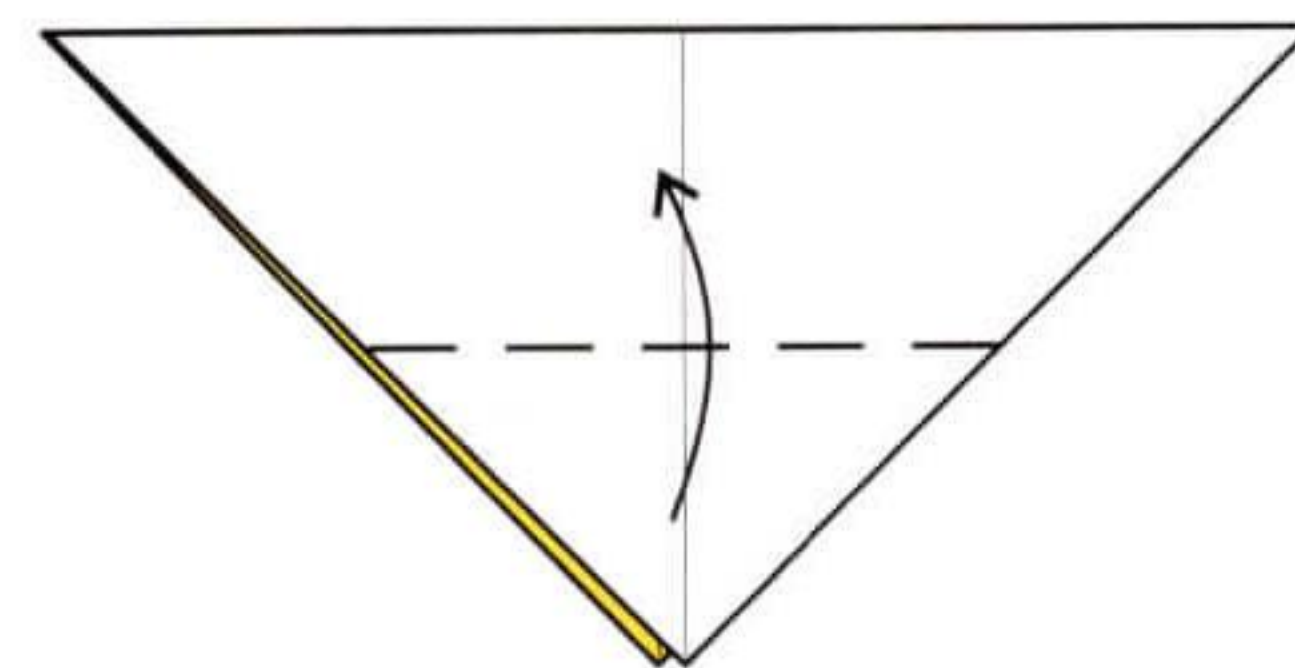

3 Fold the upper layer of the lower point up to the middle of the folded edge above.

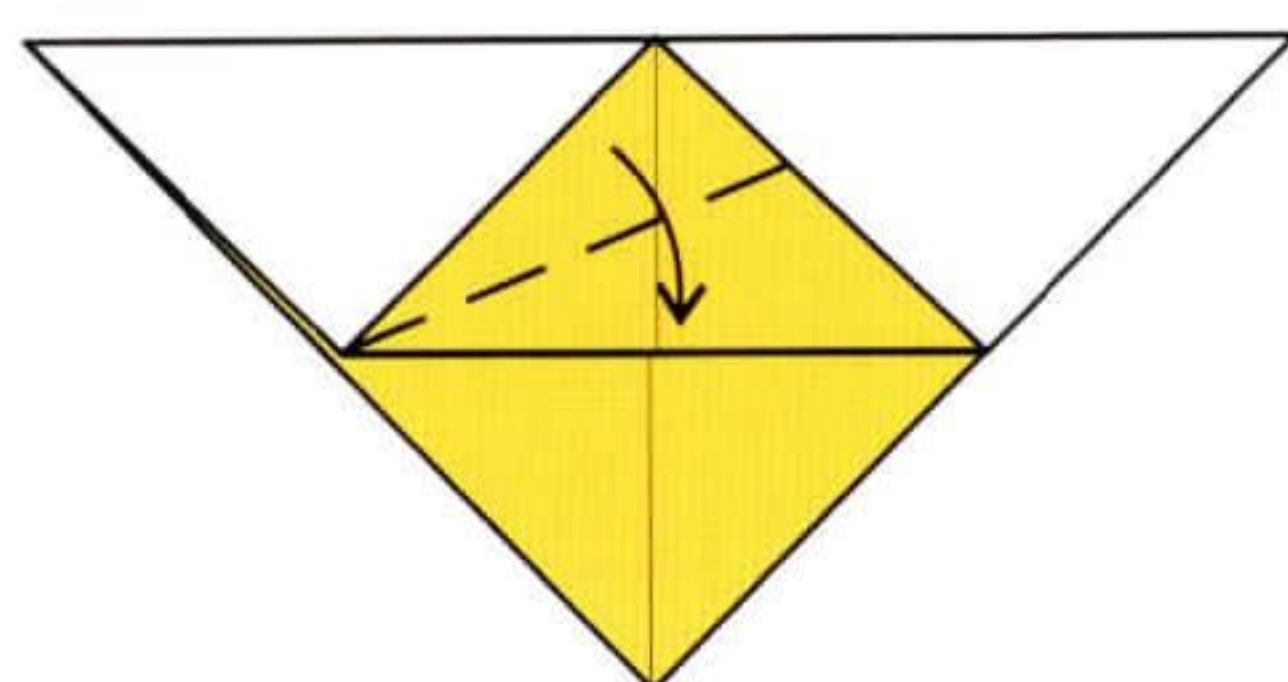

4 Fold the corner down to the adjacent folded edge.

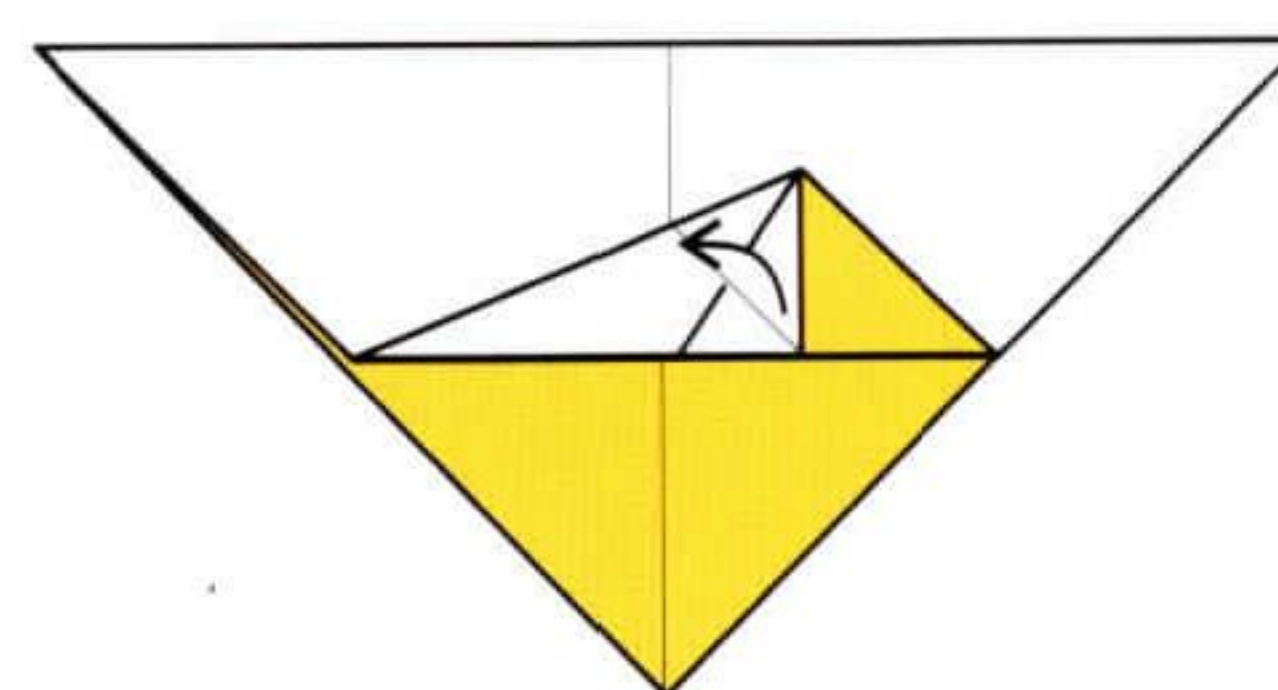

5 Fold the corner up and align the outer edge with the folded edge.

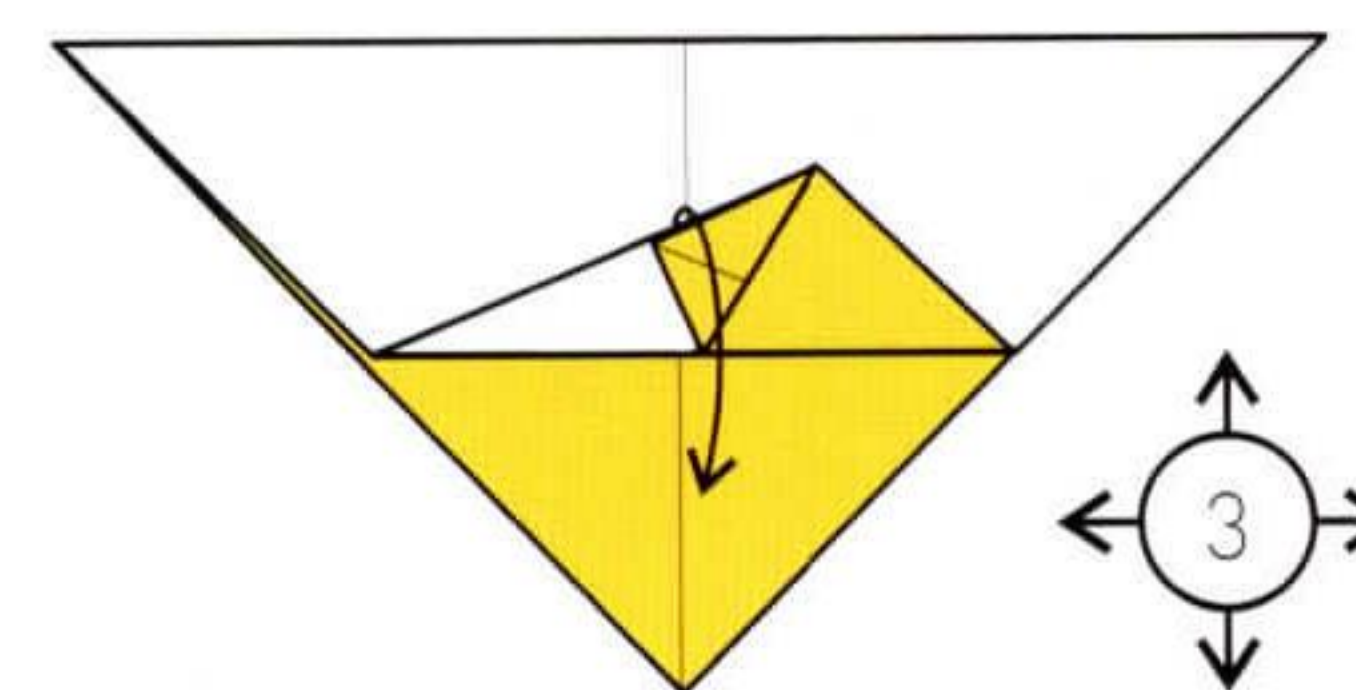

6 Unfold to step 3.

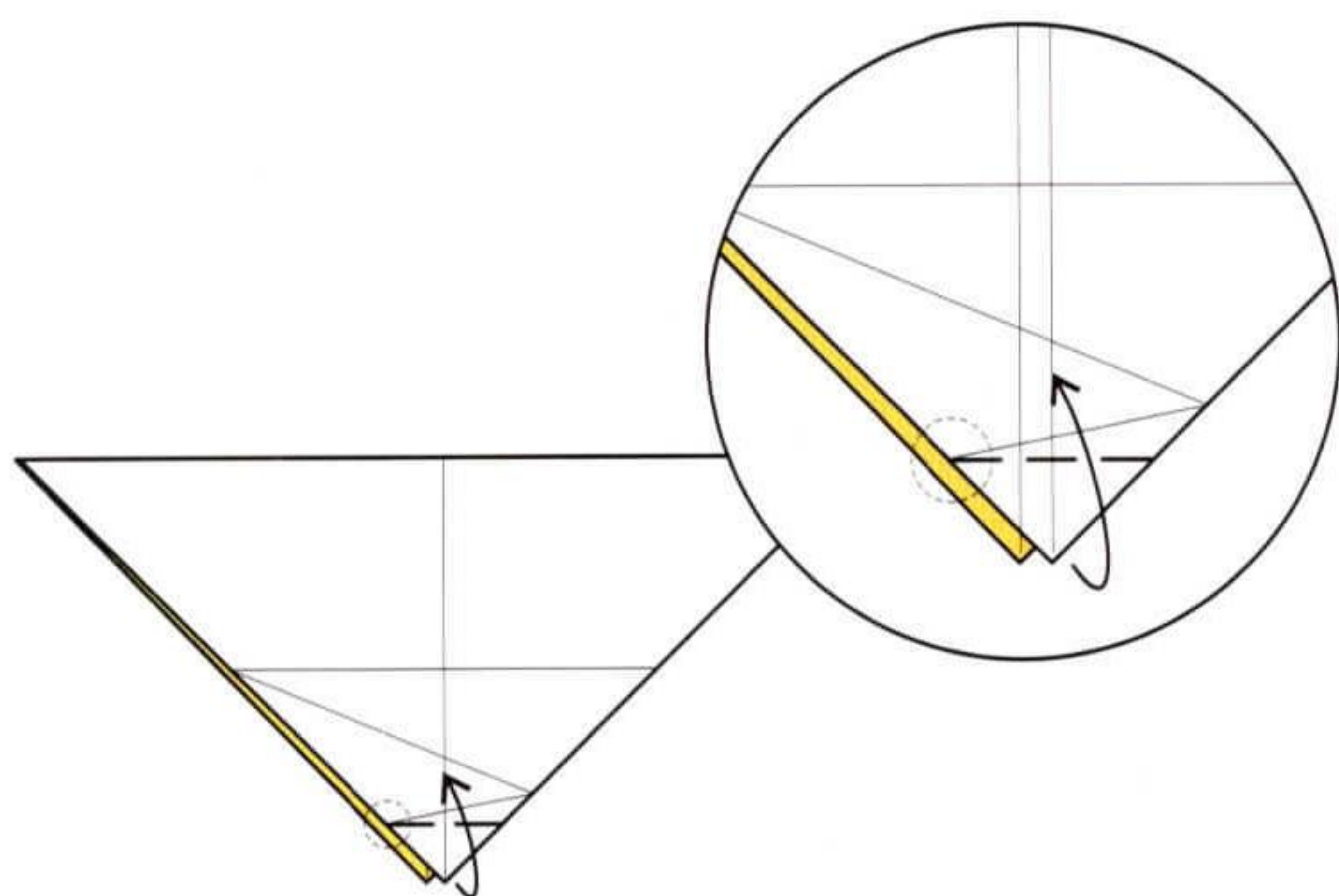

7 Fold the the lower corner up. Note the reference point as the end of the crease made previously.

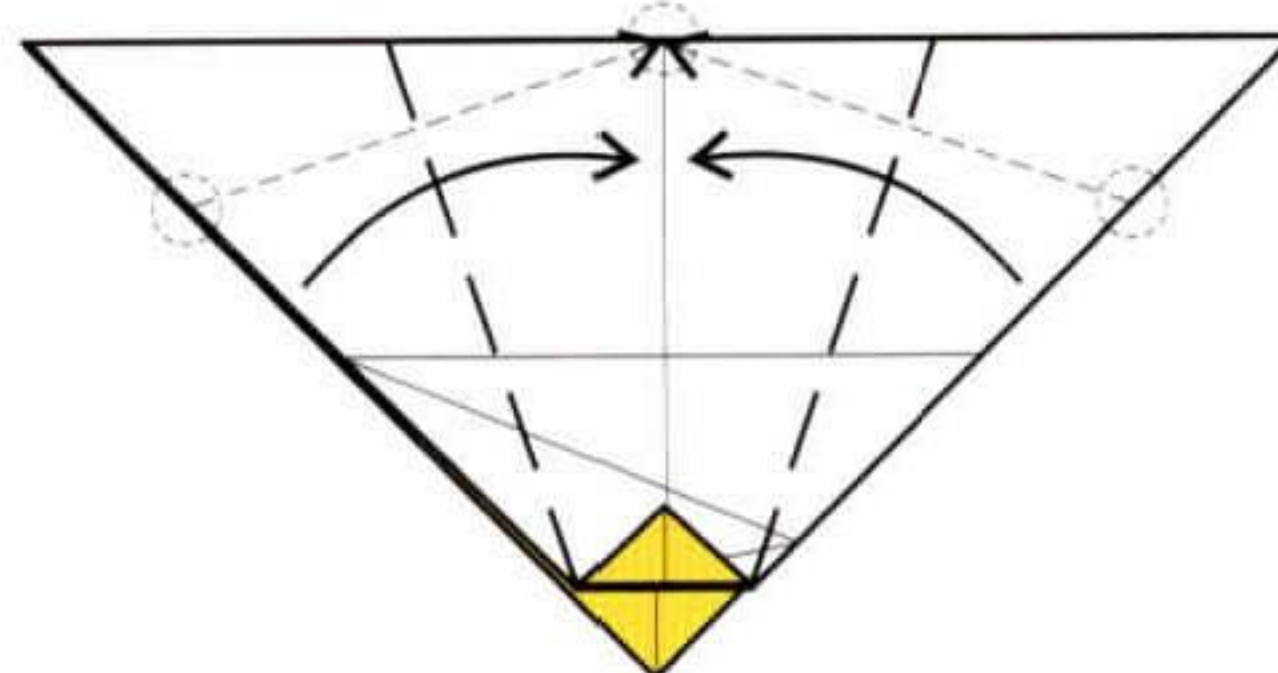

8 Fold the outer edges in. The creases start from the tip of the folded triangle and will cause the edges to touch the middle of the upper folded edge.

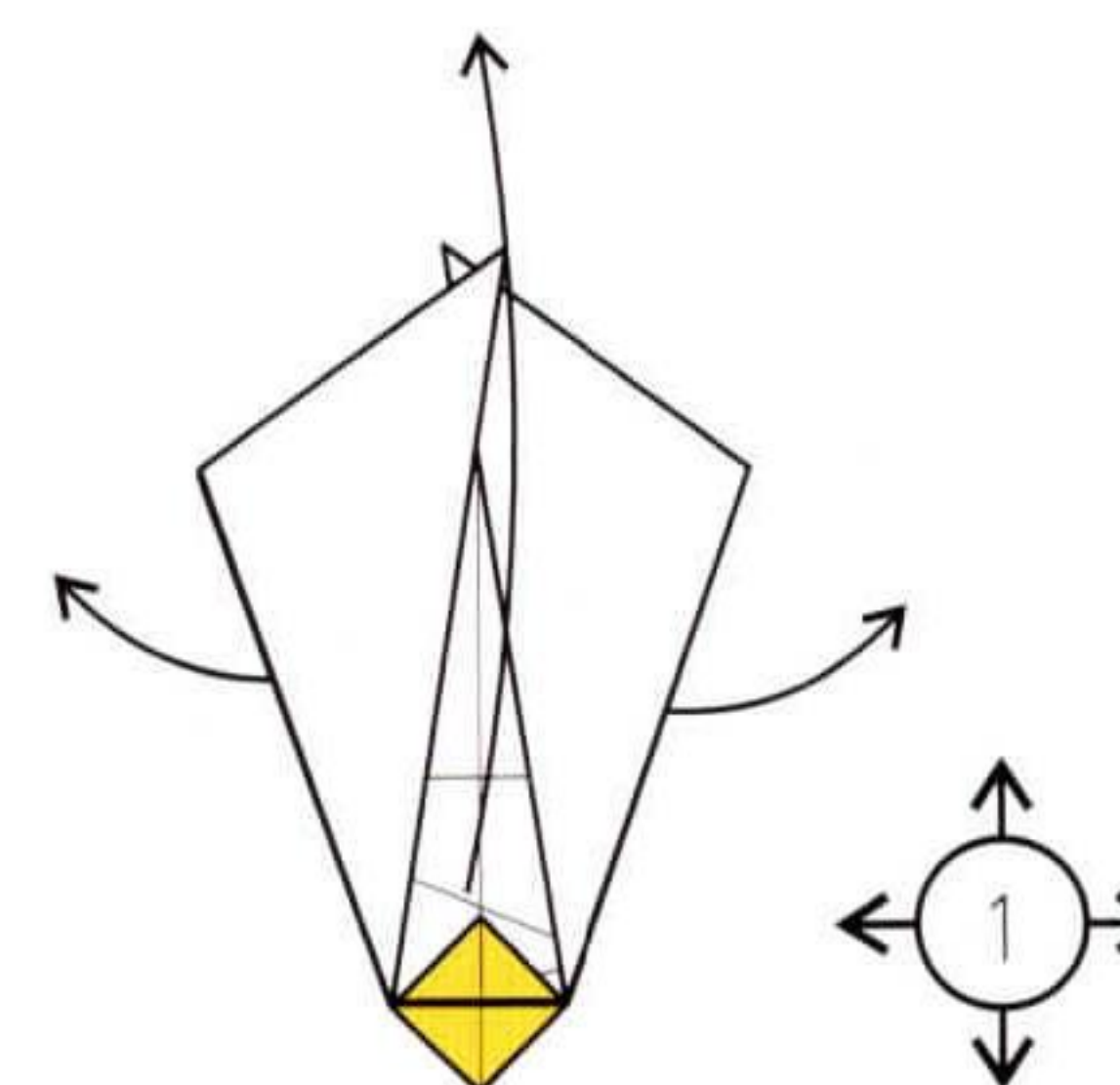

9 Unfold back to a square, but with the lower corner still folded in.

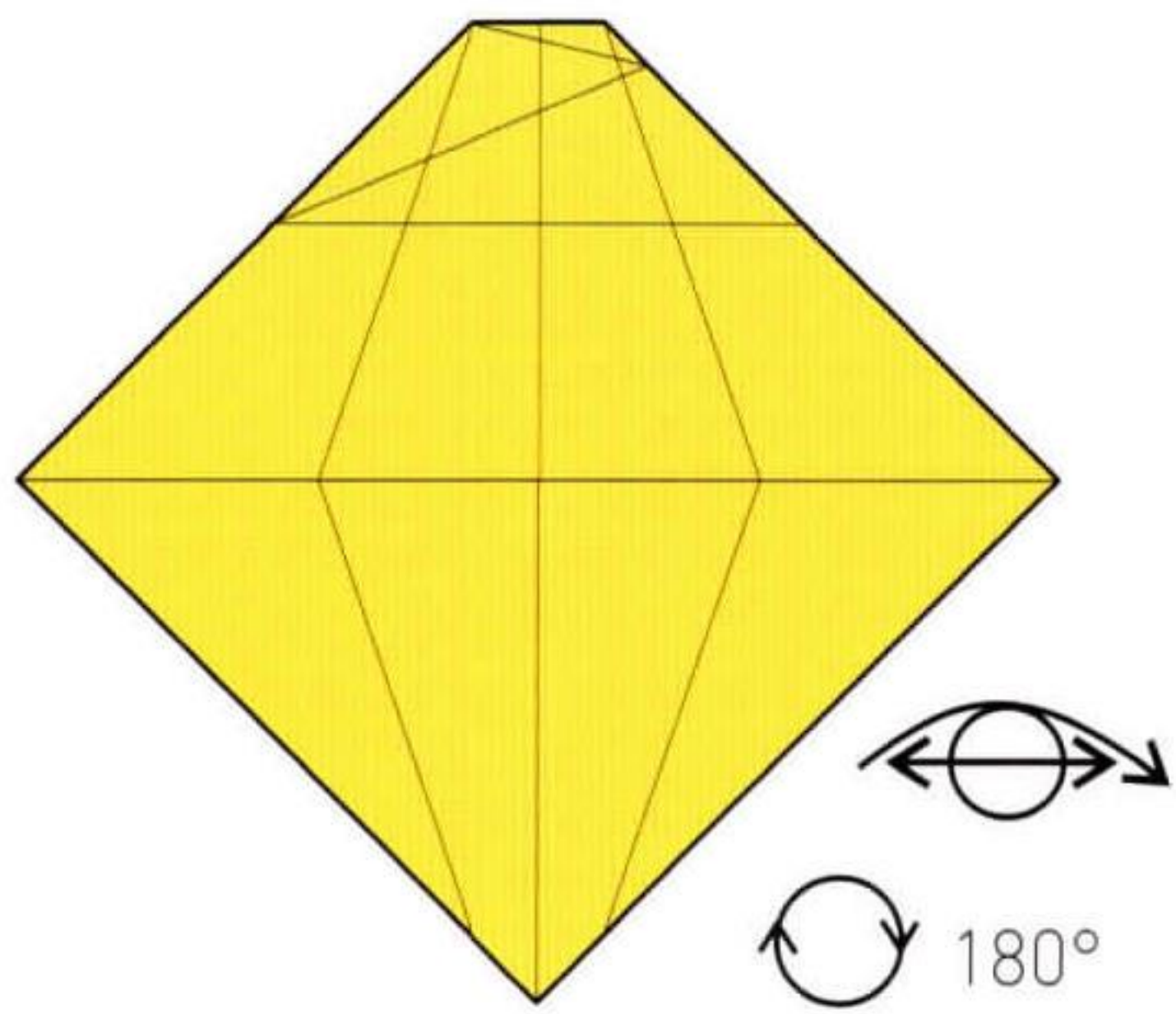

10 Turn the model over left to right and rotate by 180°.

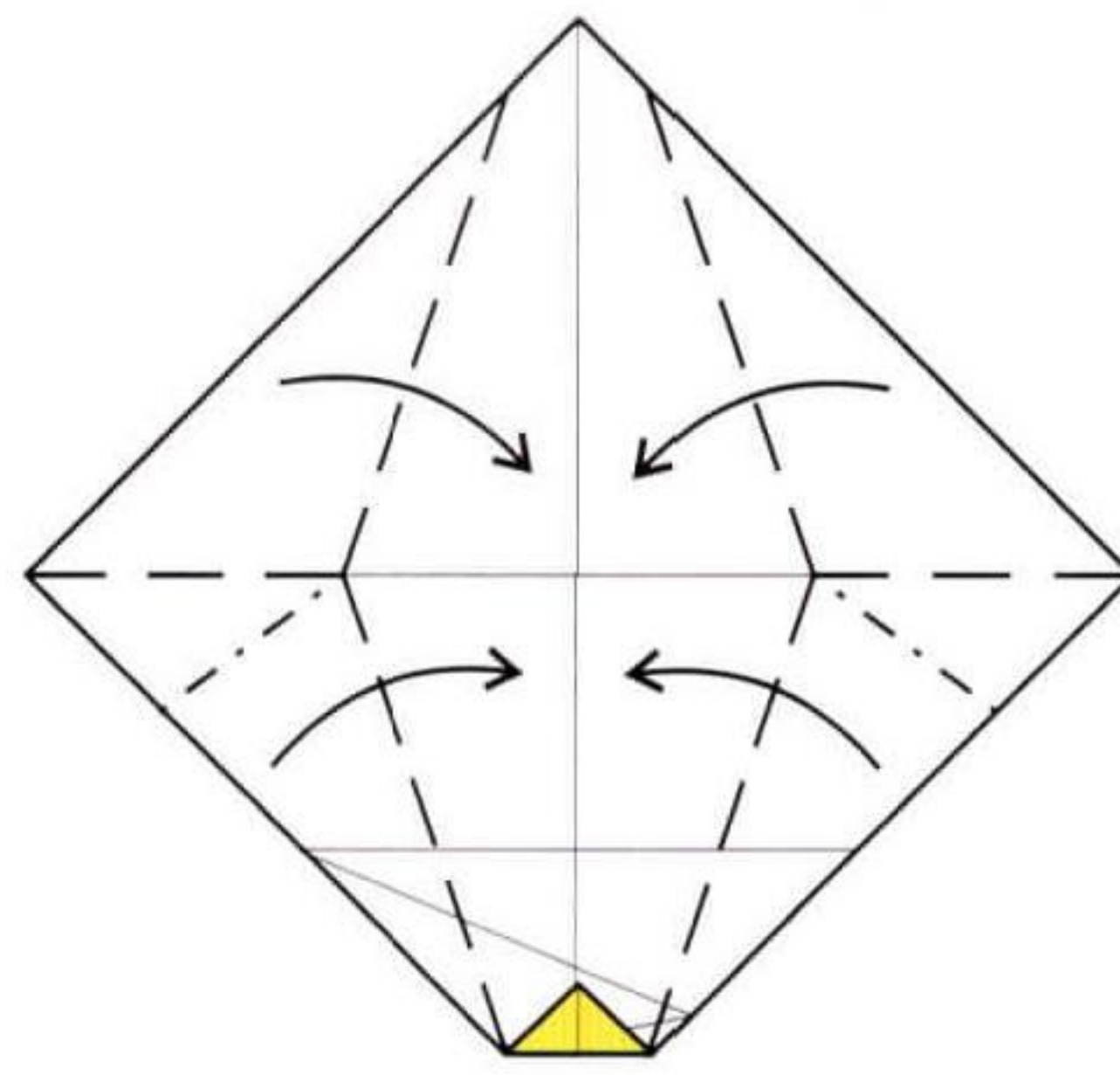

11 Fold in the outer edges along the creases made previously.

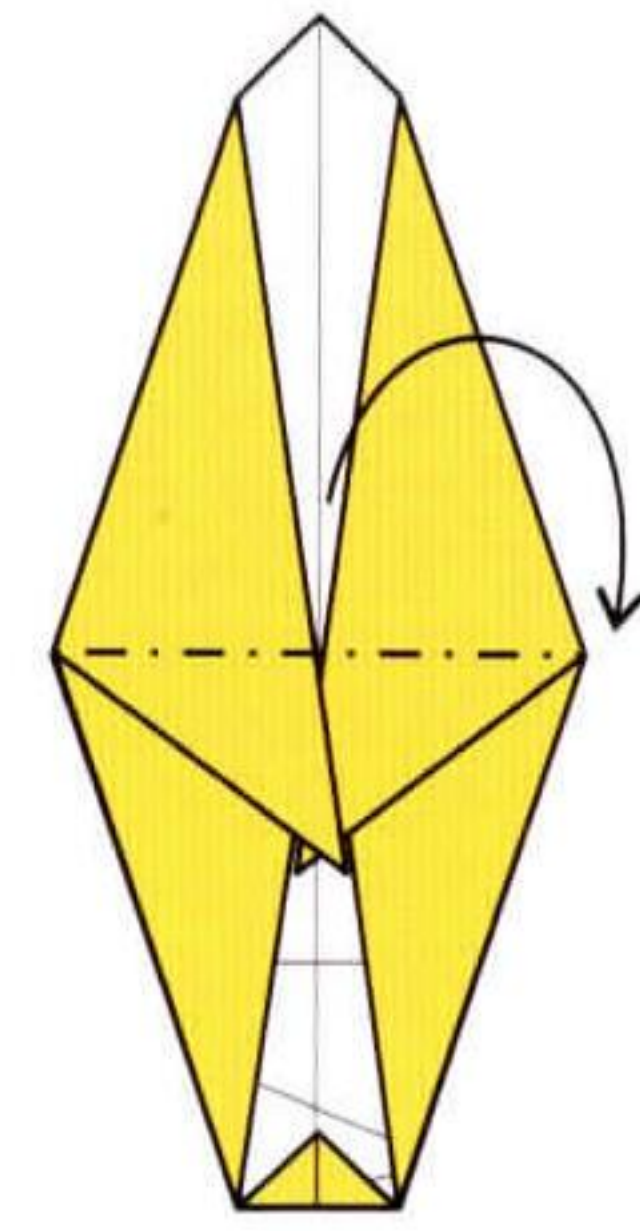

12 Fold the upper section to the back.

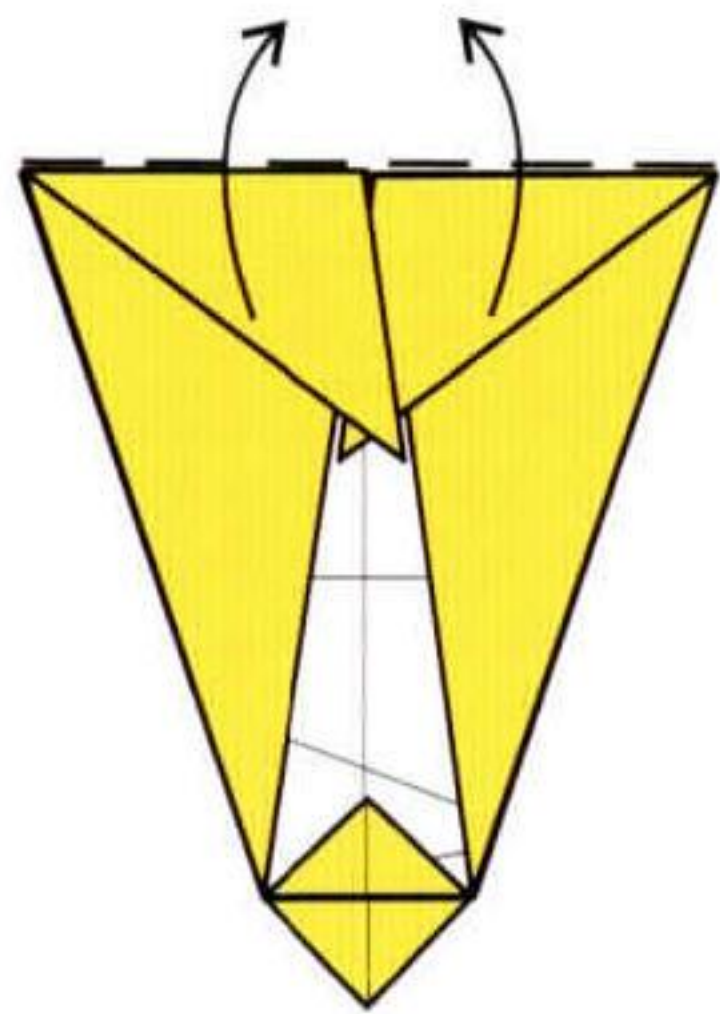

13 Fold the corners up.

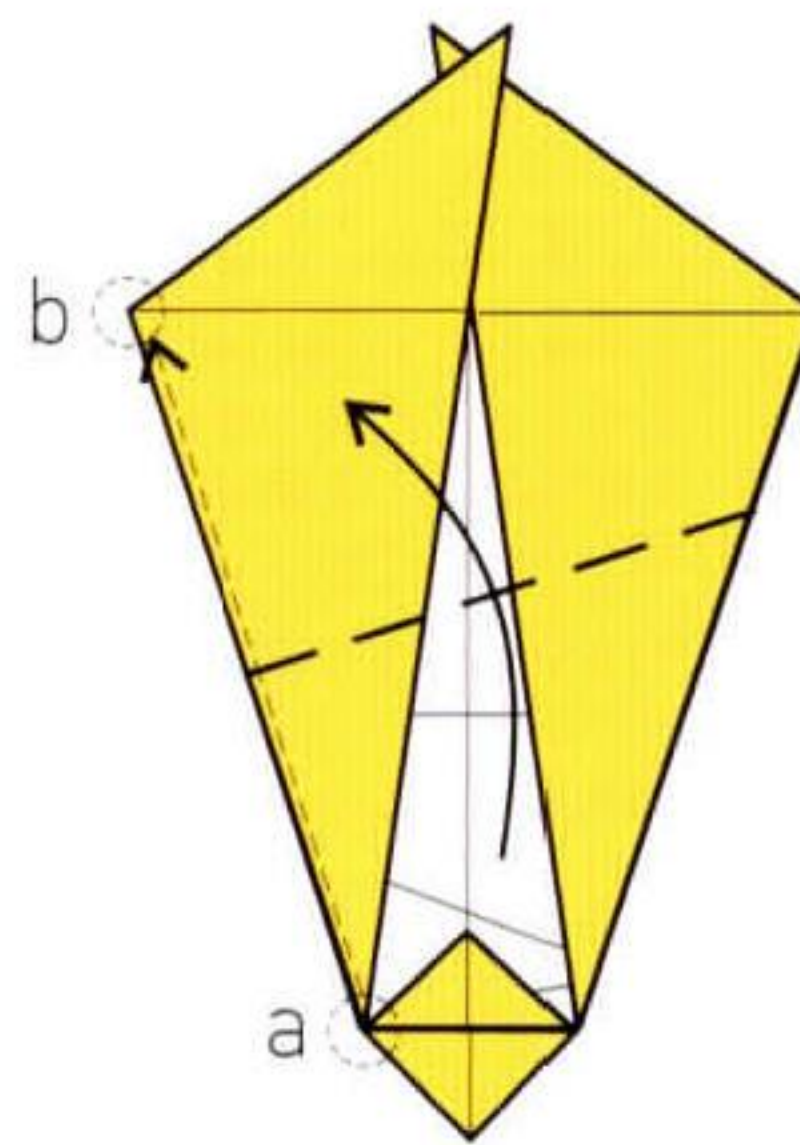

14 Fold the lower section up, causing the lower corner (a) to touch the upper corner (b).

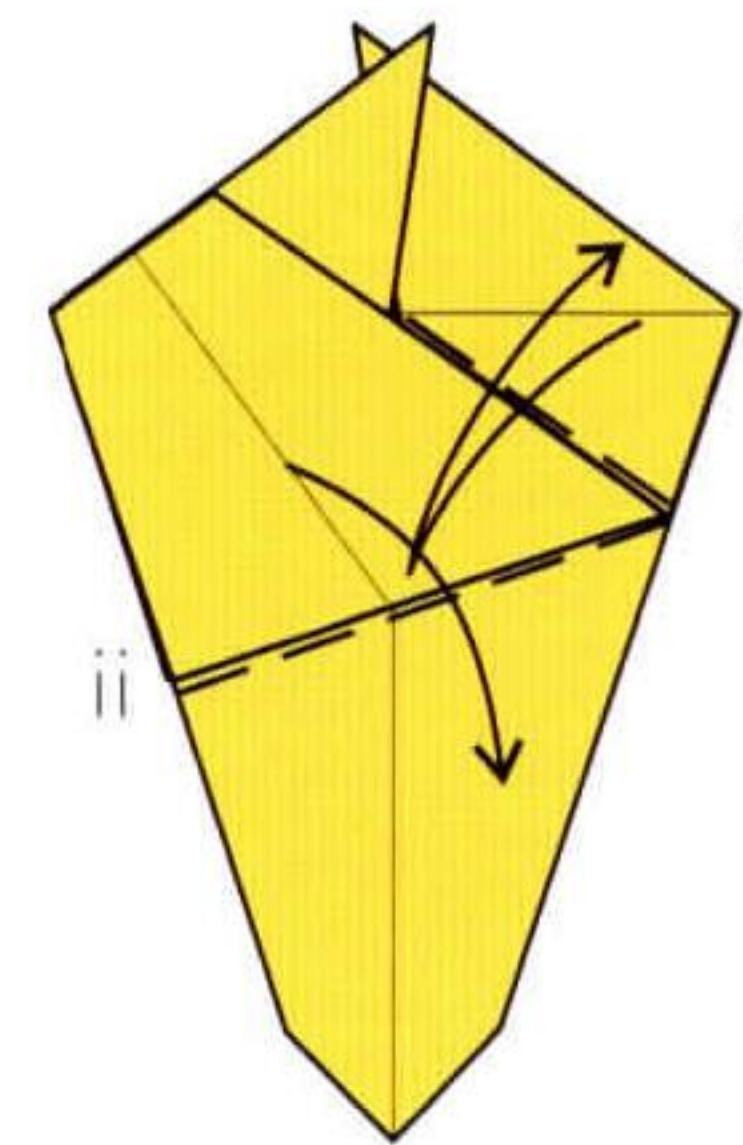

15 (i) Fold and unfold the upper corner over the adjacent edge. (ii) Then fold the section back.

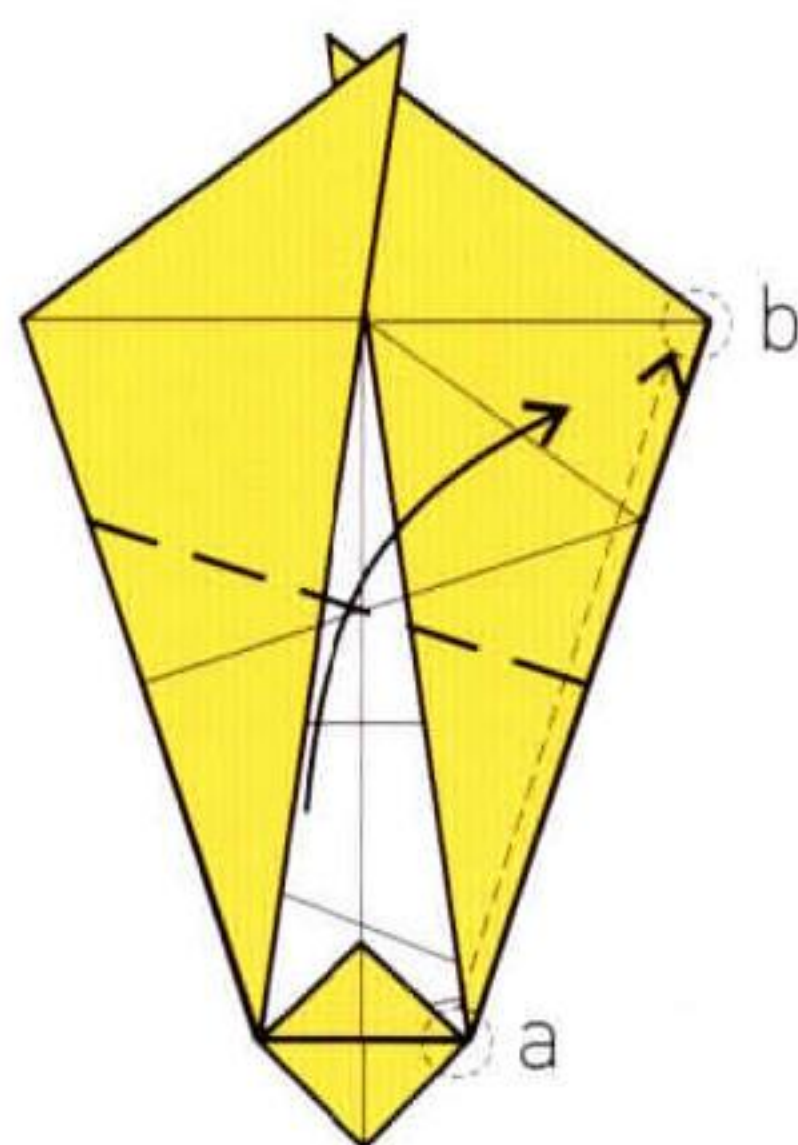

16 Fold the other side up so the lower corner (a) touches the upper corner (b).

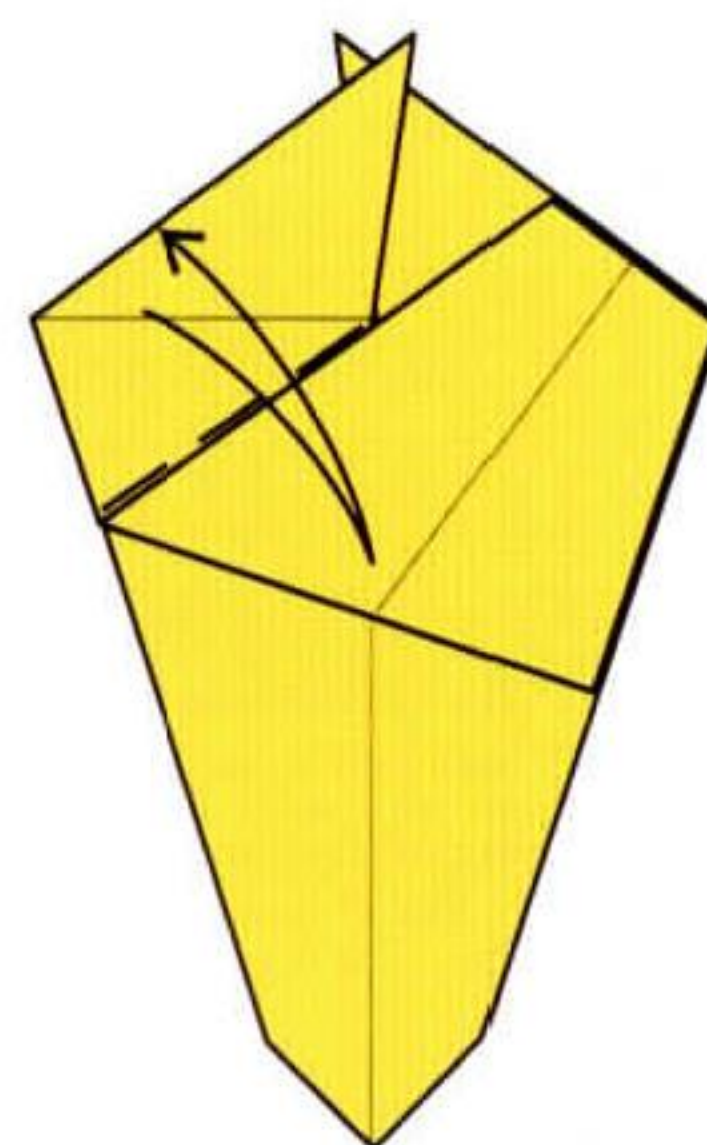

17 Fold and unfold the upper corner over the adjacent edge.

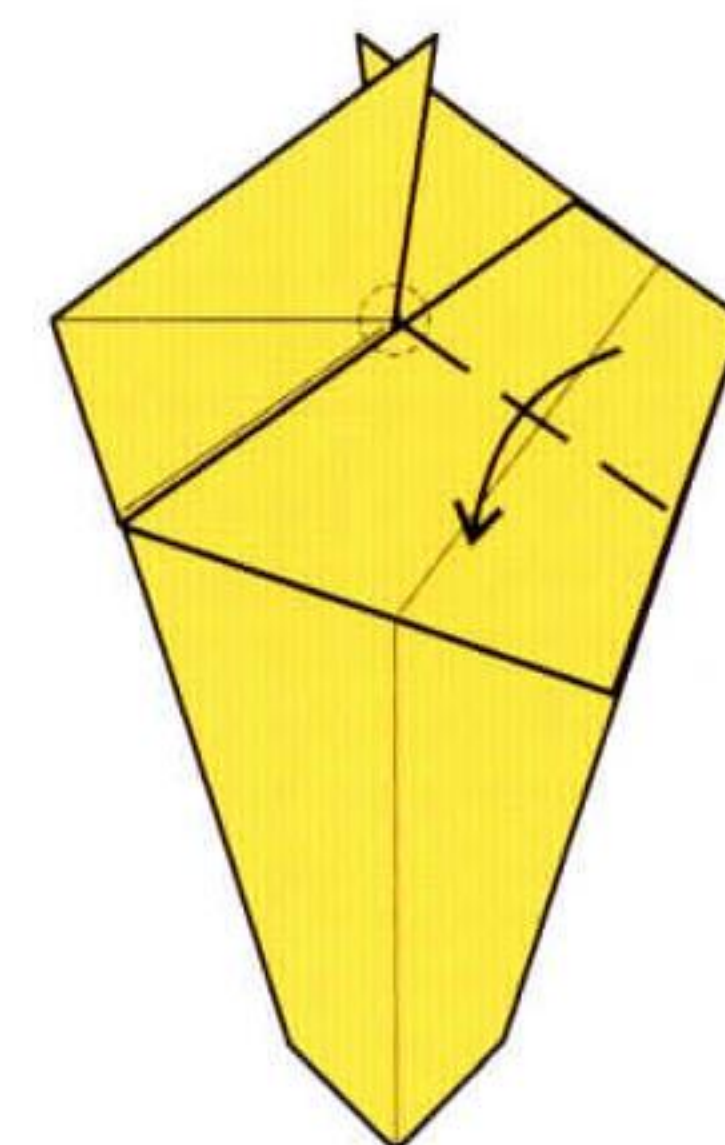

18 Fold the end of the upper section in. The fold should start from the point where the paper touches the folded edge beneath.

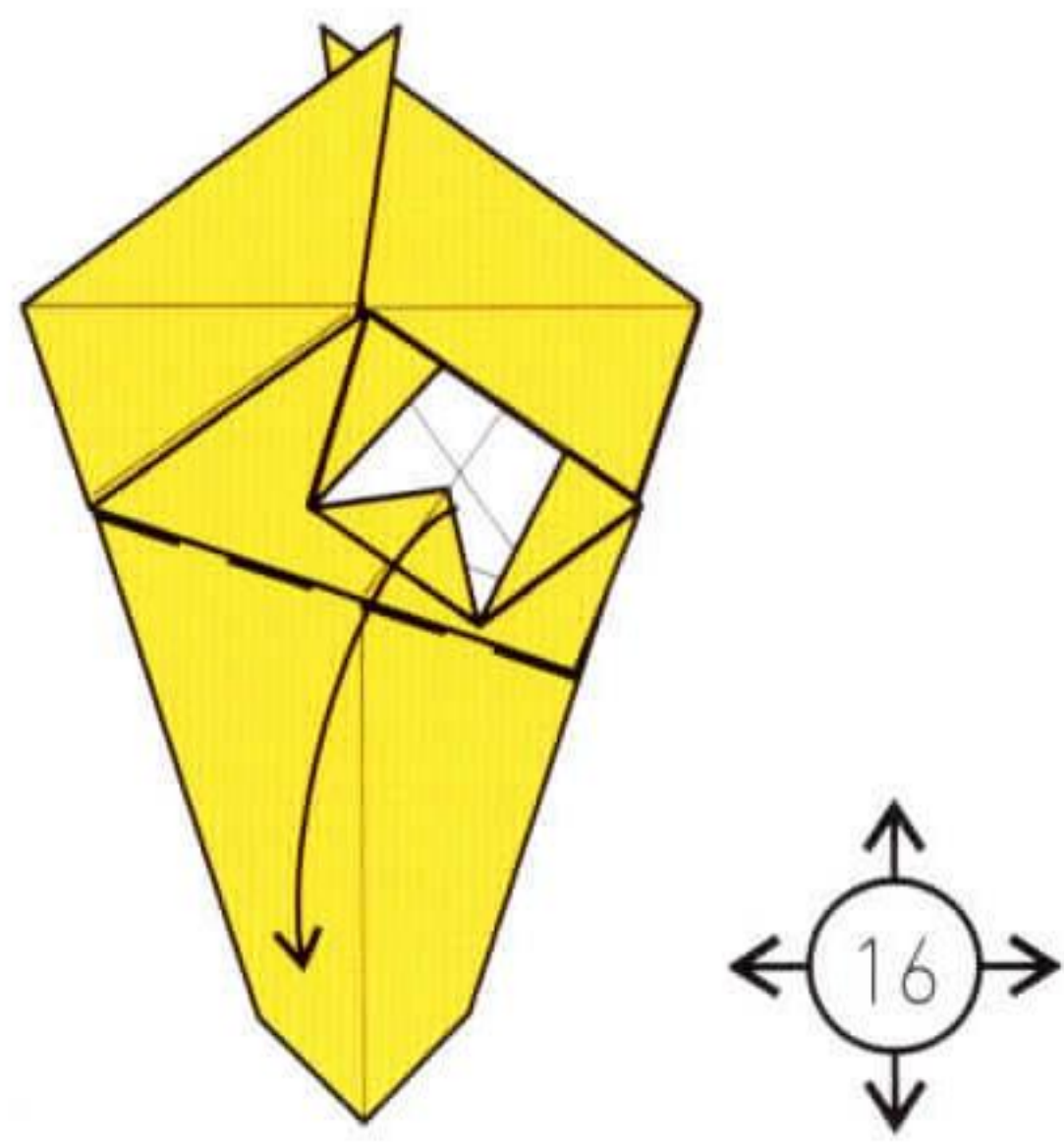

19 Unfold the folded section to step 16.

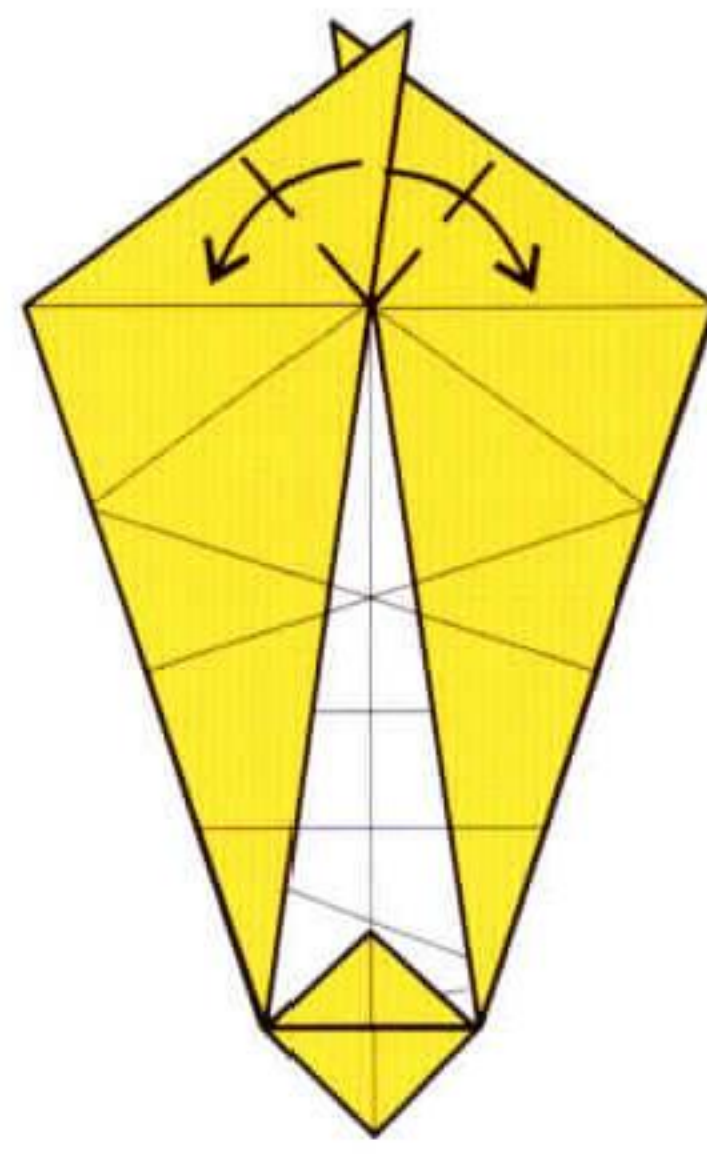

20 Fold the upper corners out to align the inside edges with the horizontal creases.

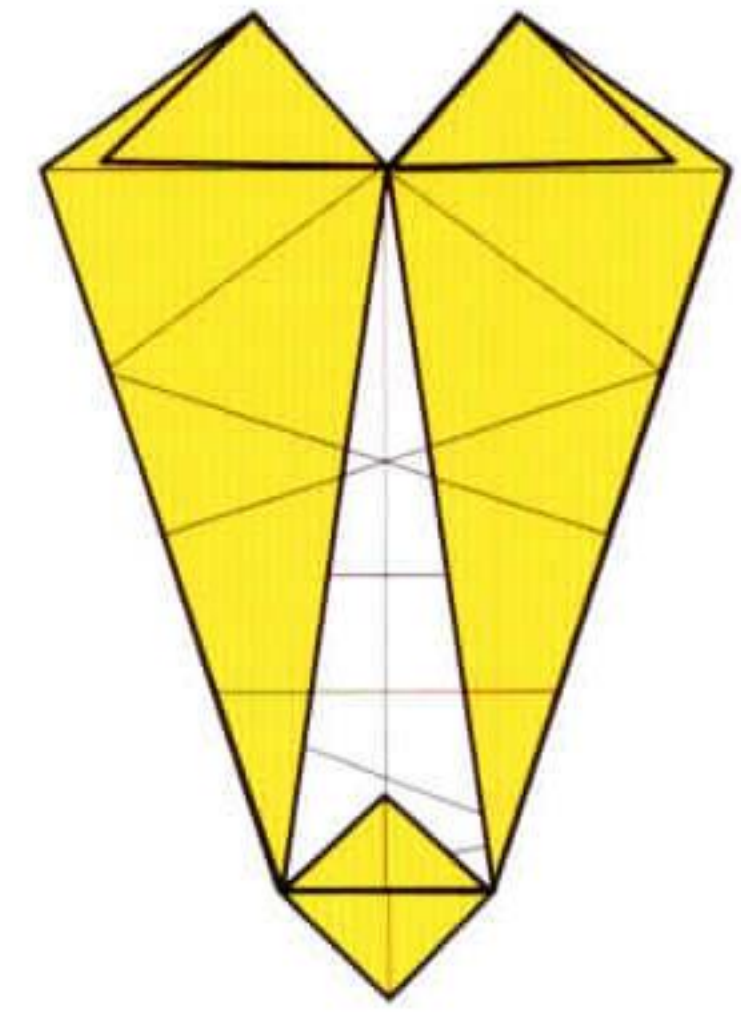

21 Module complete.

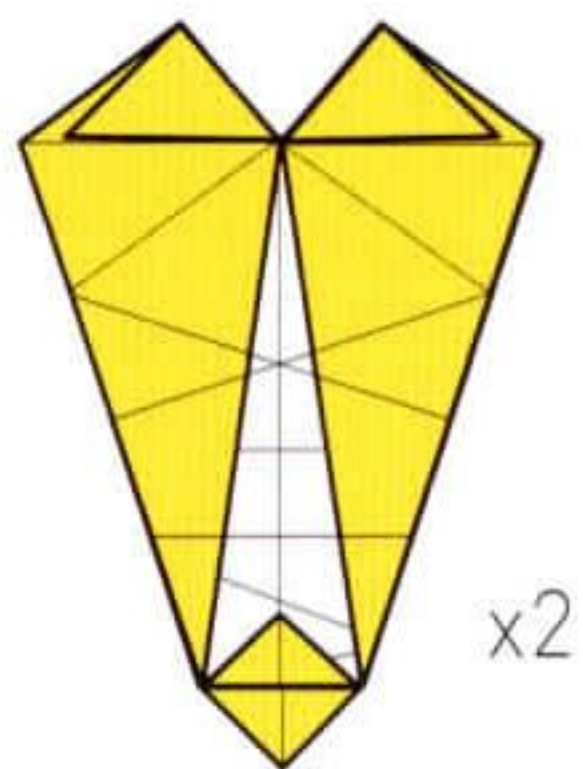

22 Make a second module in the same way.

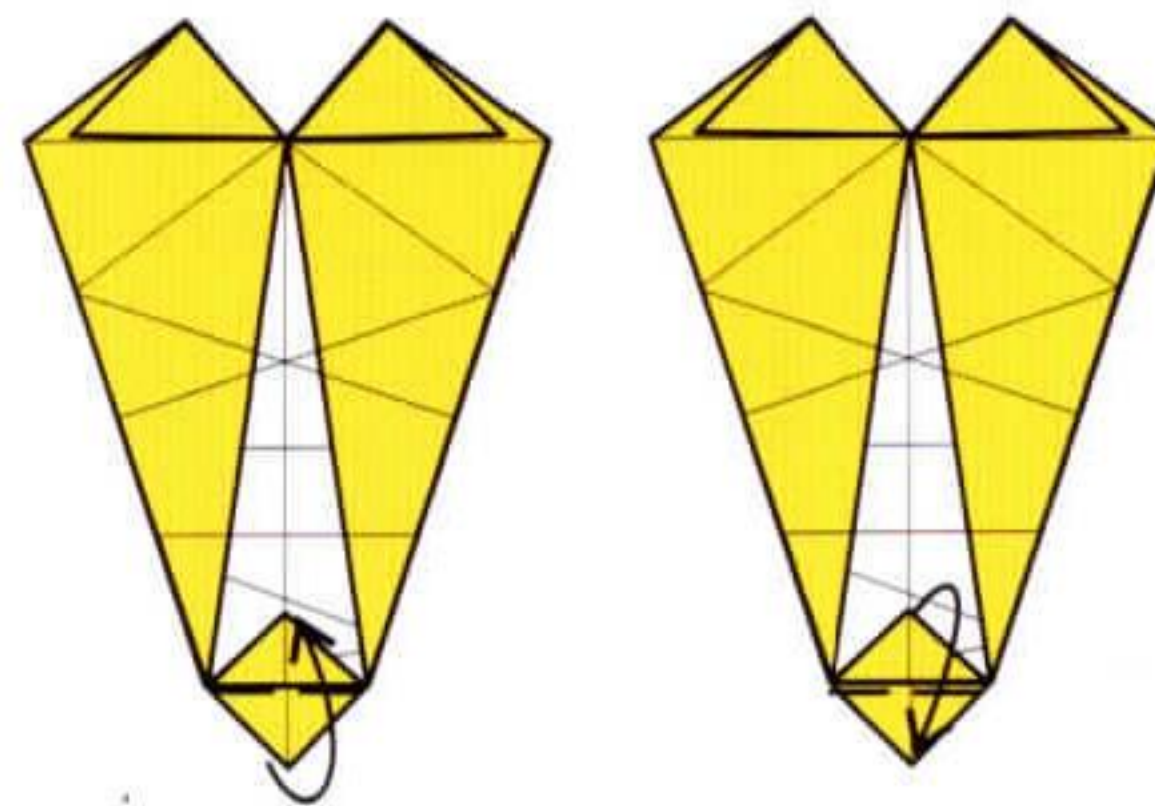

23 For one module fold the tip up, for the other fold it down.

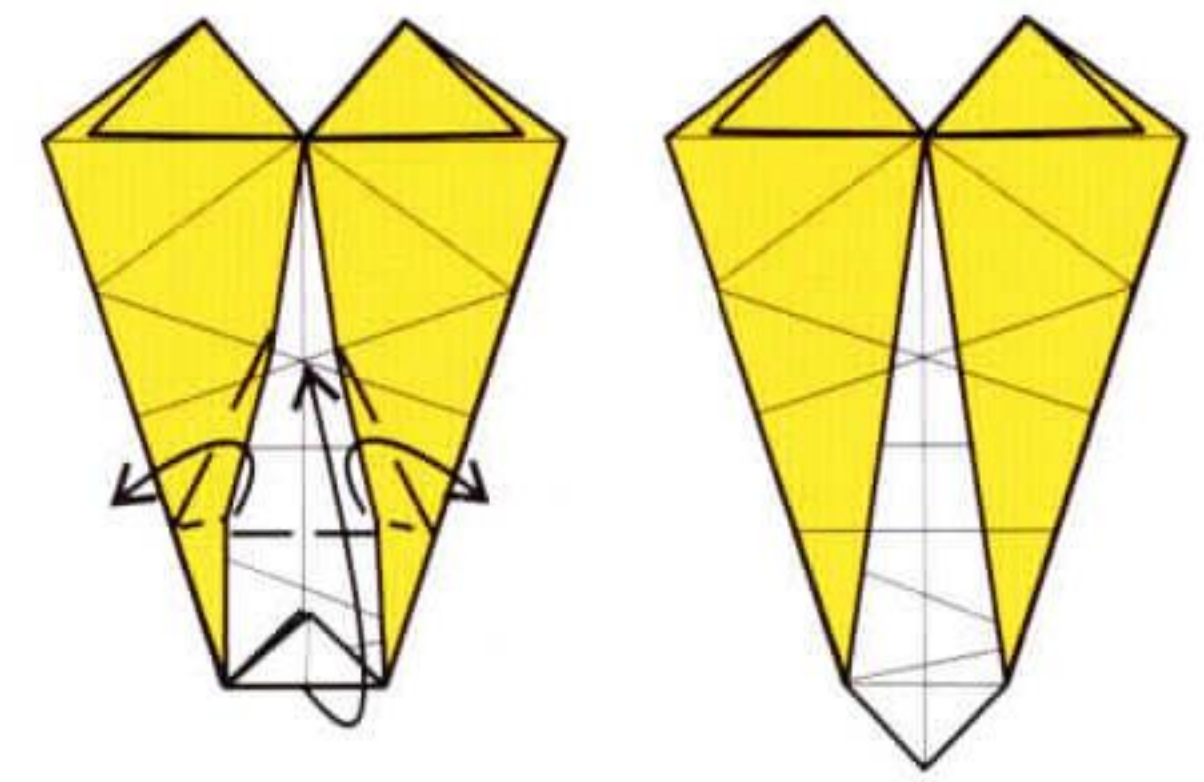

24 Open up the end of the left module.

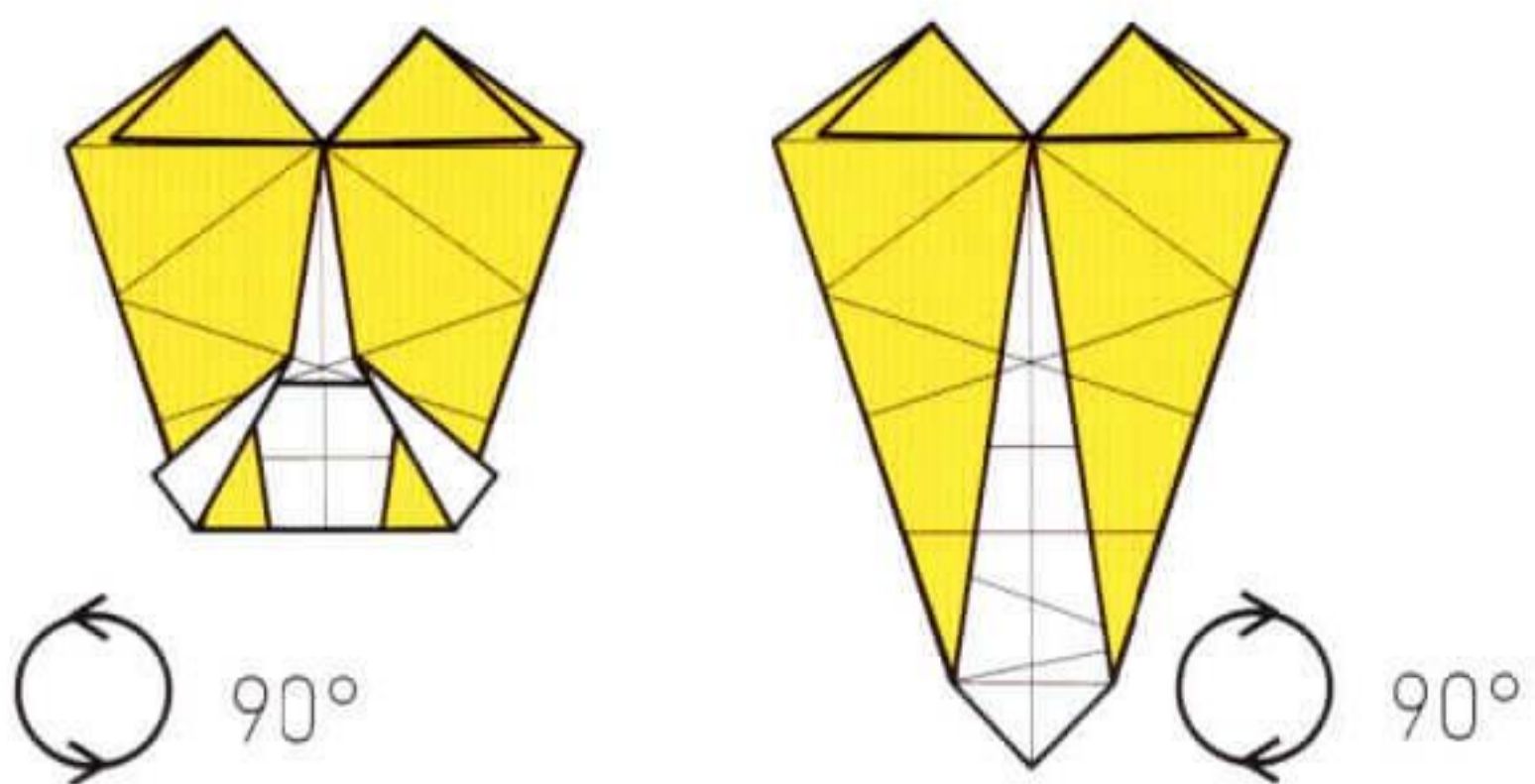

25 Rotate the two modules by 90° to point the tip of one into the opening in the other.

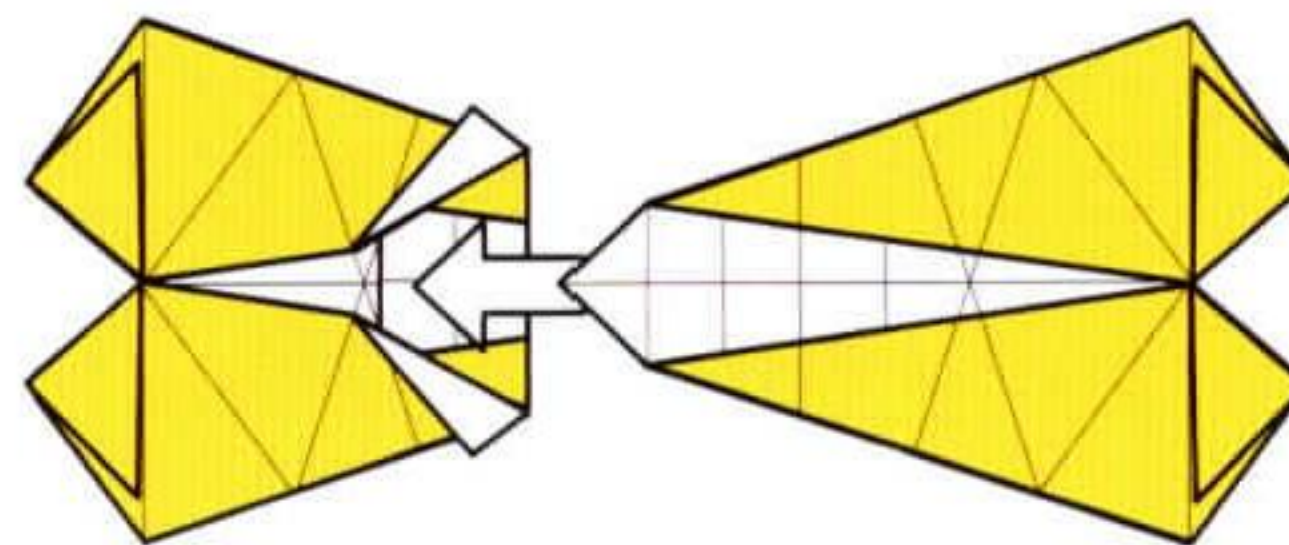

26 Insert one module inside the other.

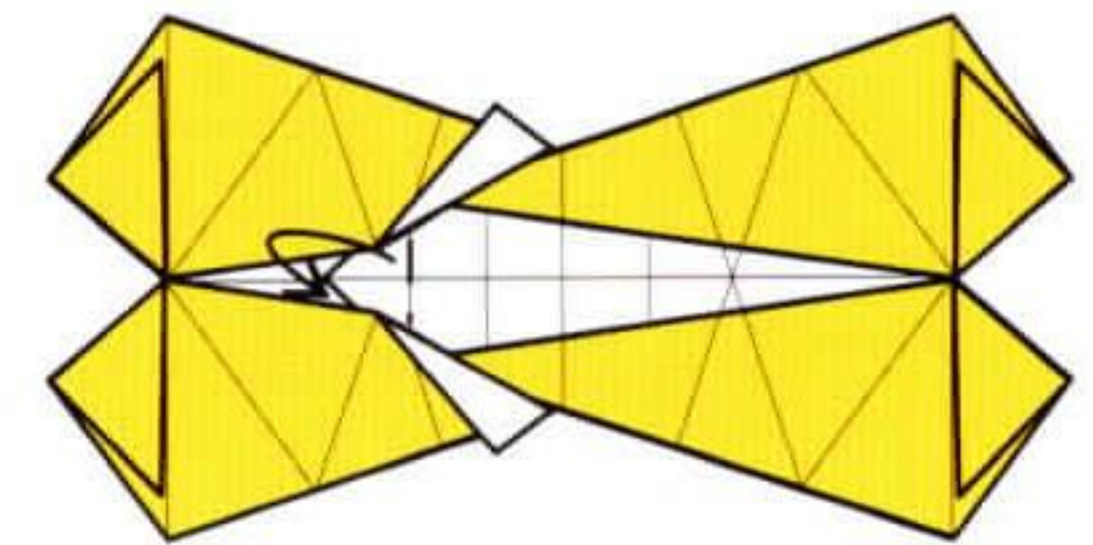

27 Fold the tip of the module being inserted behind to lock the two modules together.

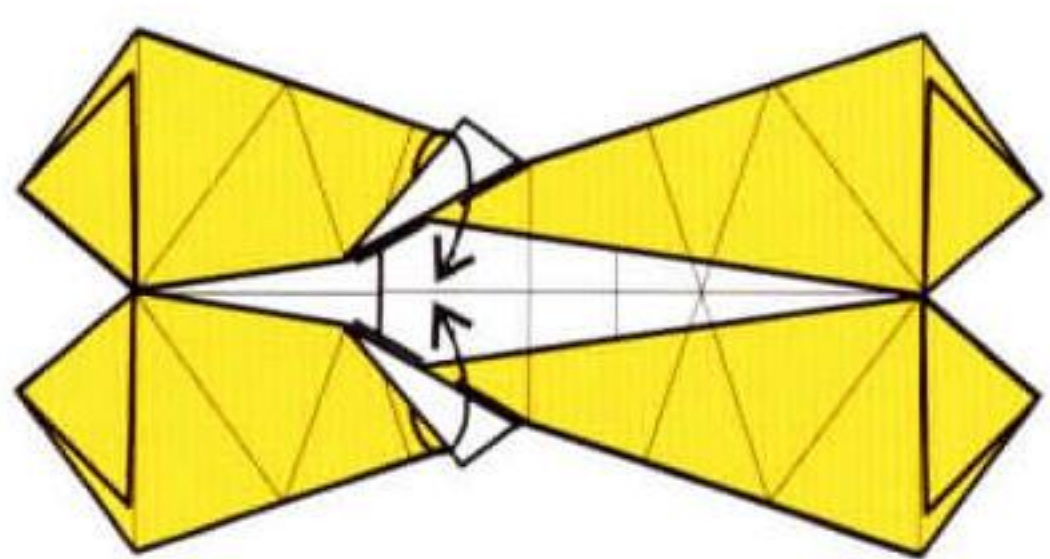

28 Fold the paper on the receiving module back to complete the link.

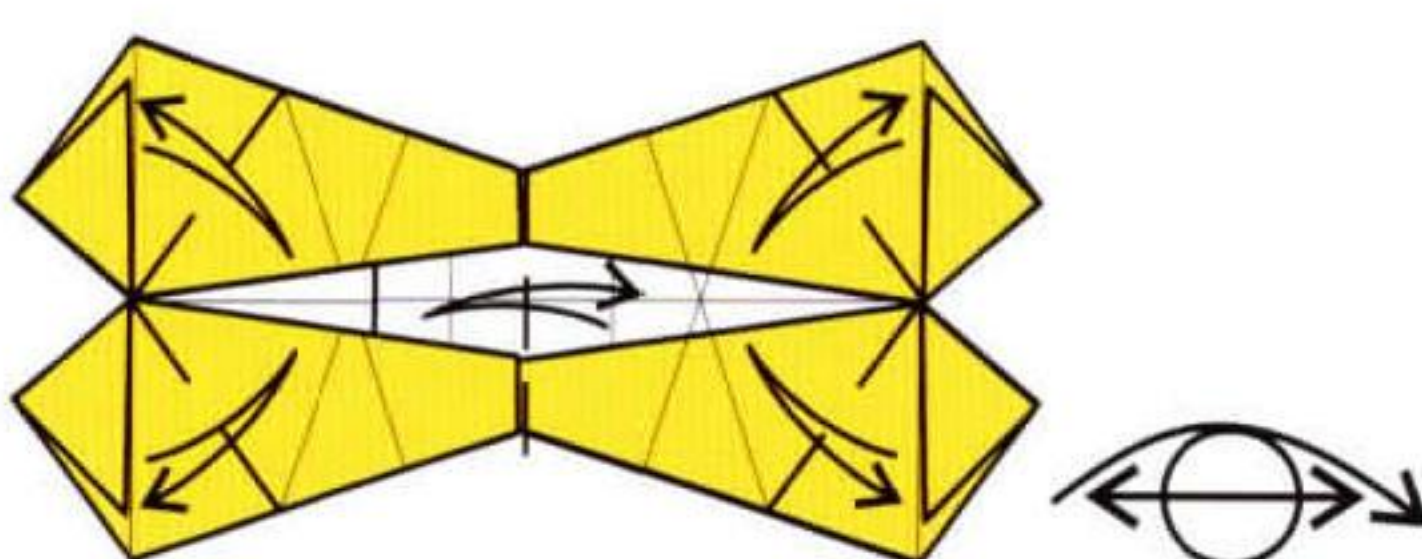

29 Crease the model around the edges of the pentagonal shapes – these form the faces of the dodecahedron. Turn model over left to right.

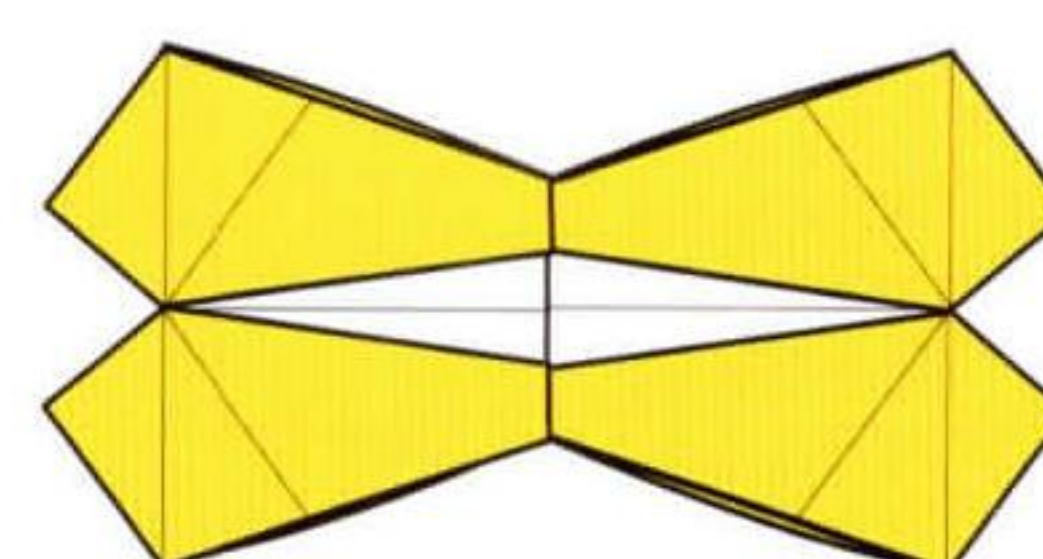

30 Make 10 more modules and link them together in pairs.

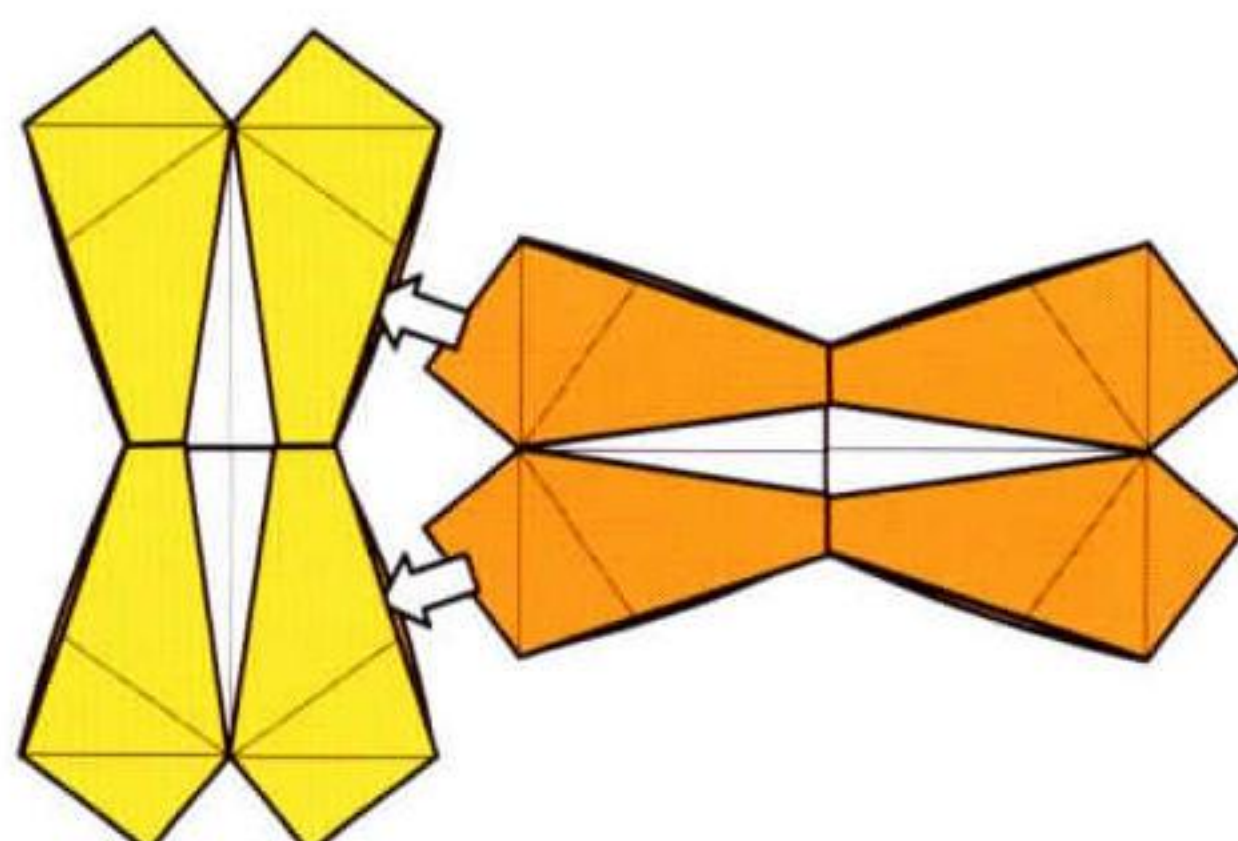

31 Insert the tabs on one pair of linked modules into the pockets of another pair.

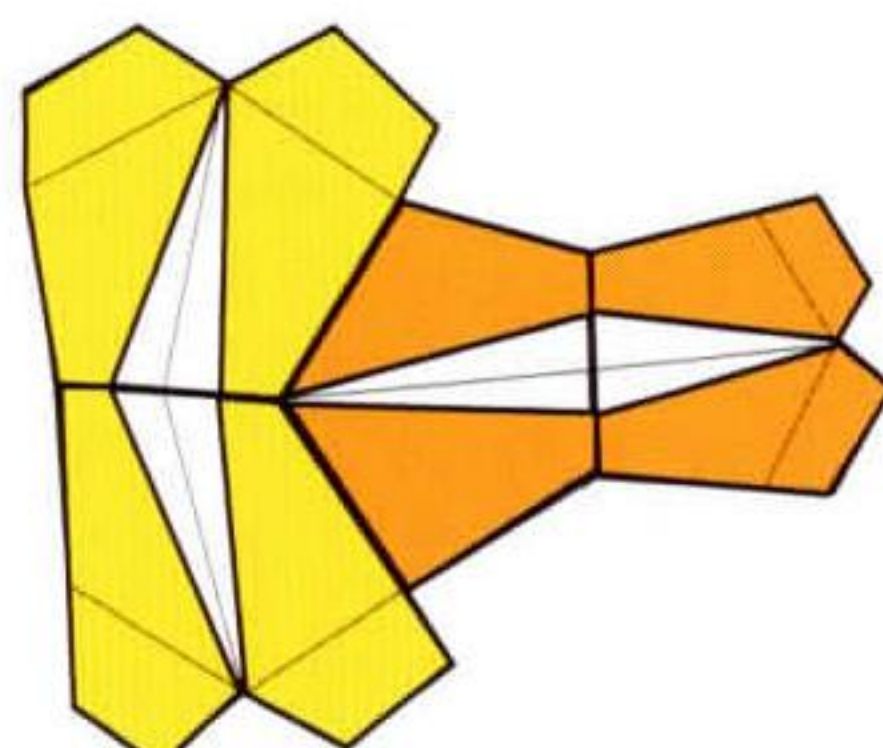

32 Two pairs of linked modules connected.

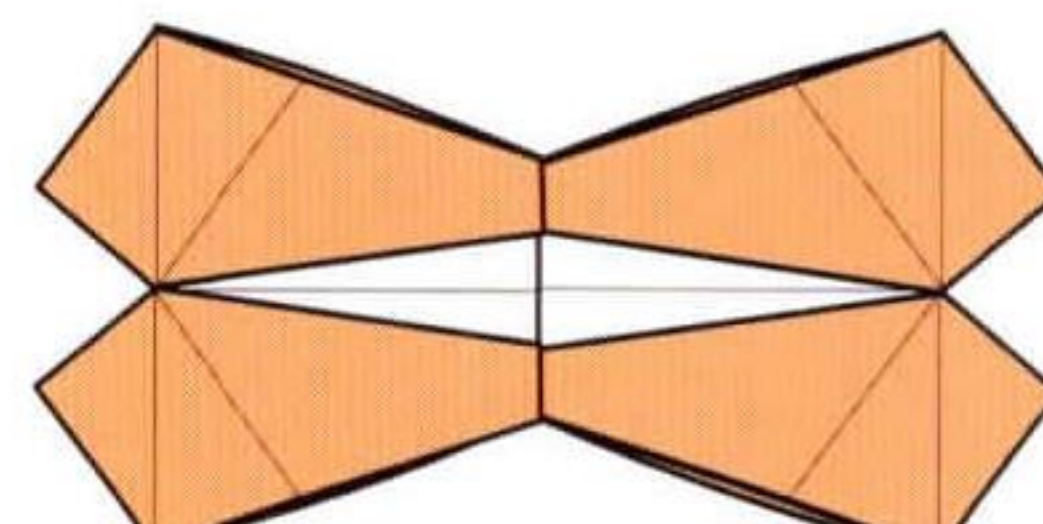

33 The final model is made from six modules in complementary colours.

LINKING THE MODULES TO FORM A DODECAHEDRON

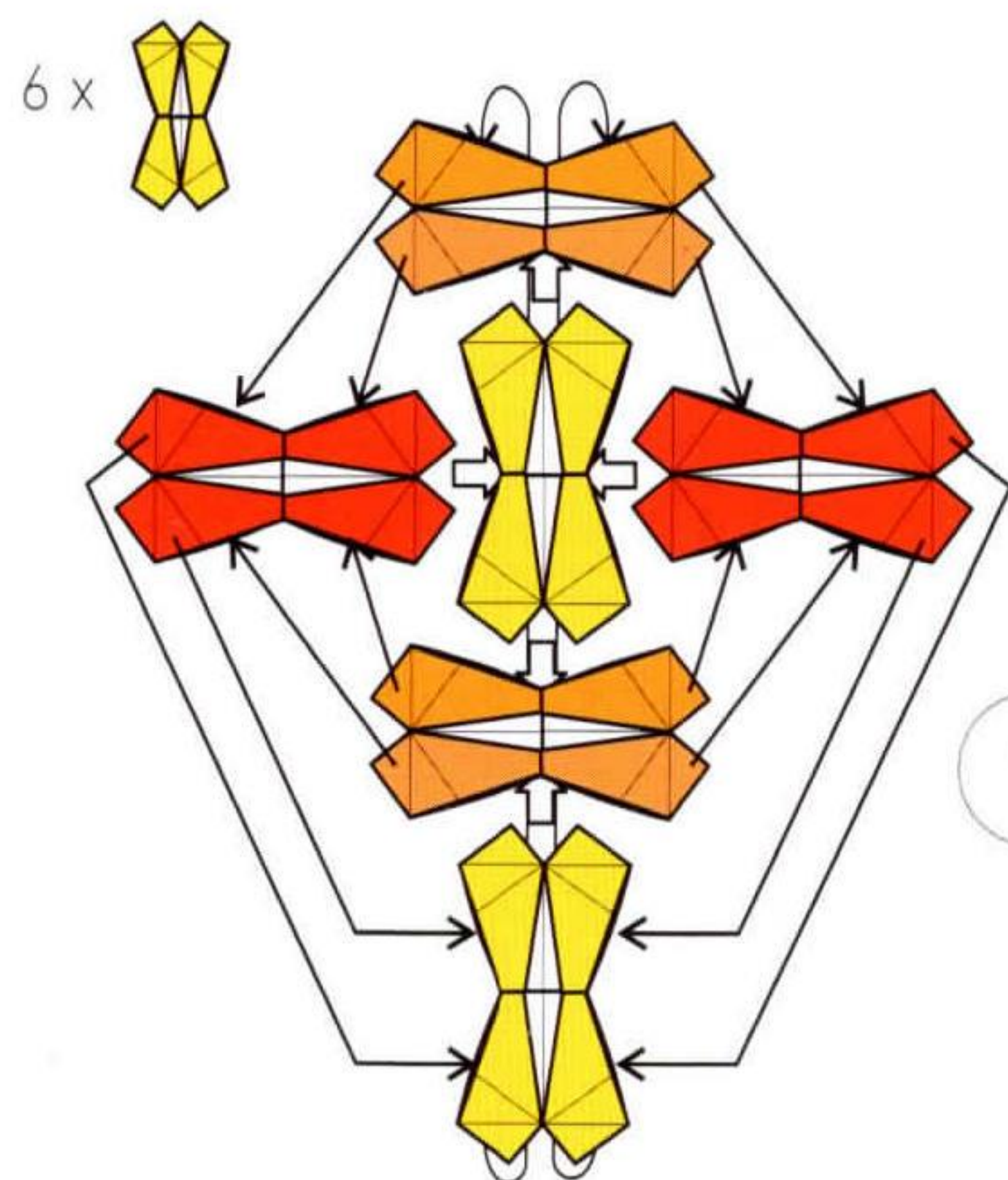

1 The final dodecahedron is made from a series of six linked modules.

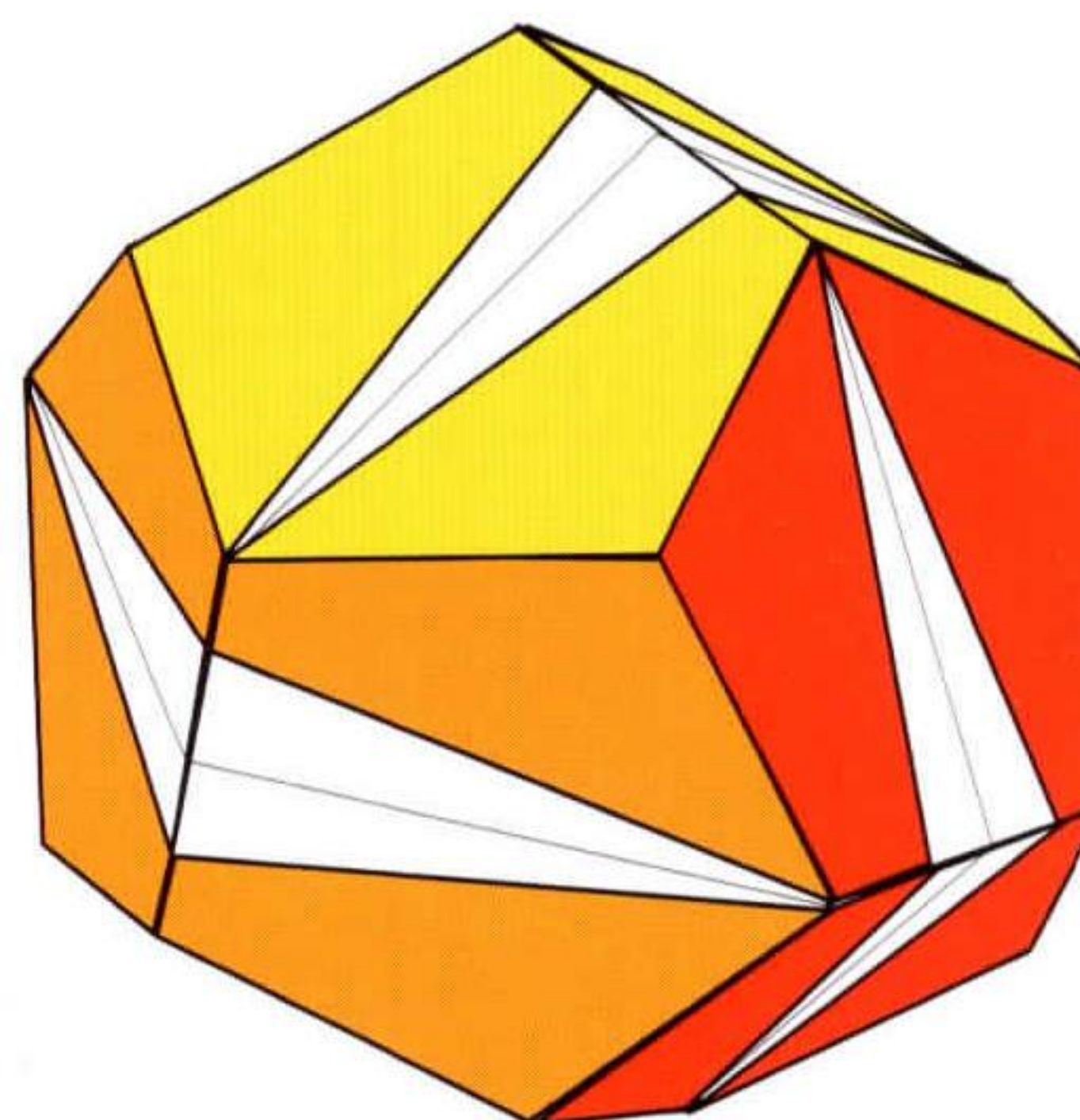

2 Complete.

Truncated Cube

**

This is a cube with the corners removed. The model is made from six similar units that fit neatly together. The final model is formed by a tessellation of squares and triangles.

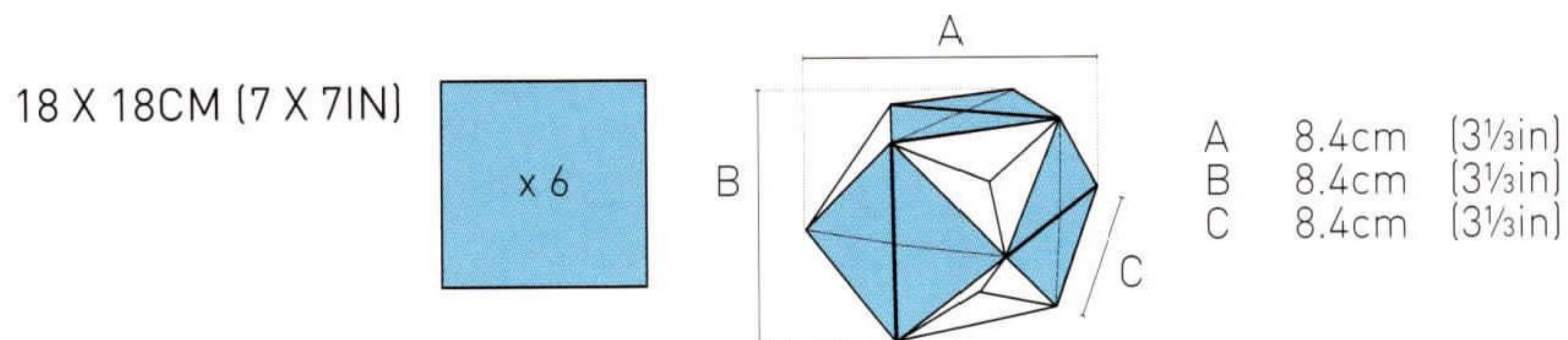

THIS MODEL IS MADE FROM SIX EQUAL-SIZED UNITS.
FOR EACH UNIT START WITH A SQUARE, COLOURED SIDE UP.

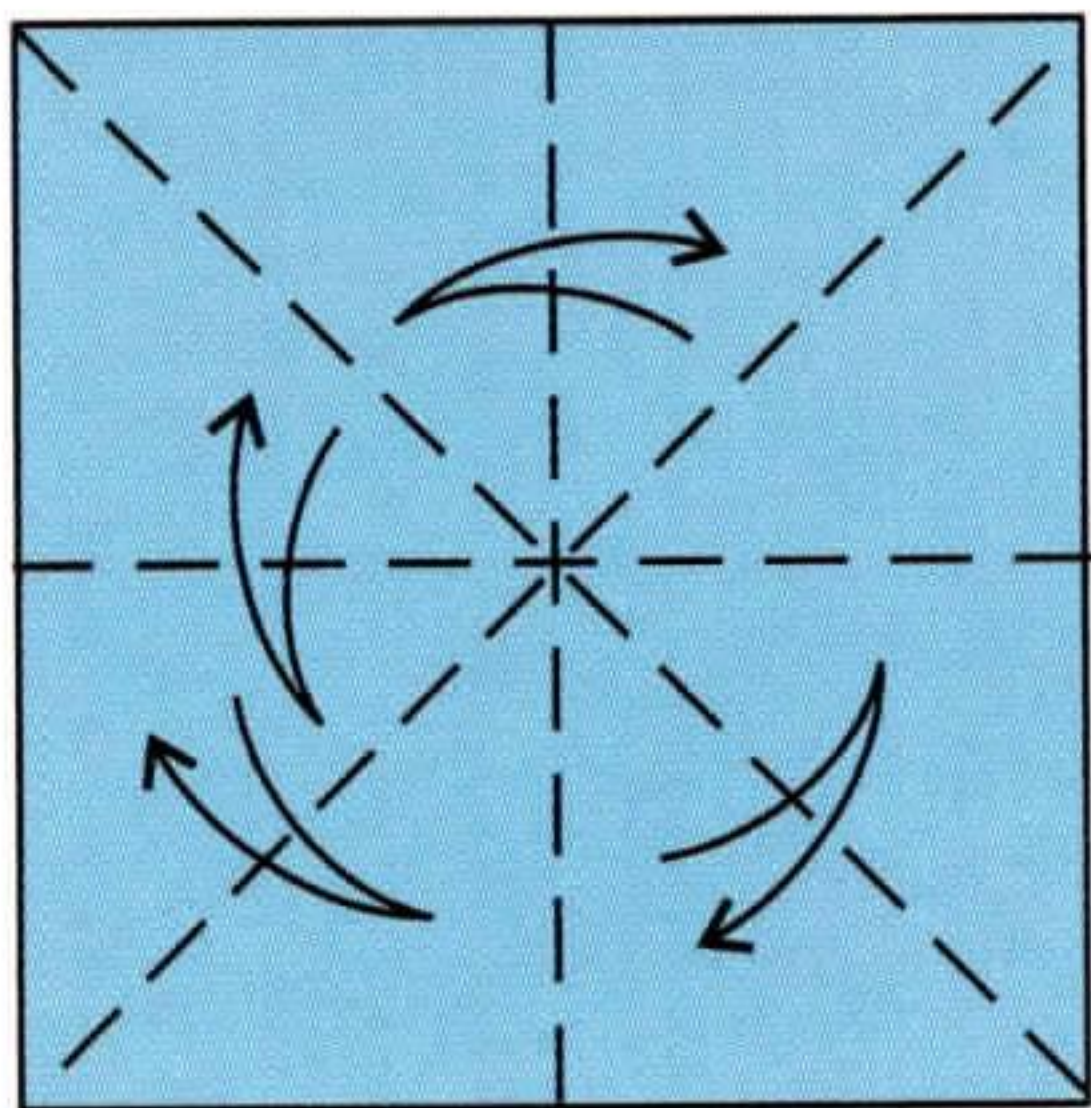

- 1 Fold and unfold the square in half lengthwise and diagonally along all axes.

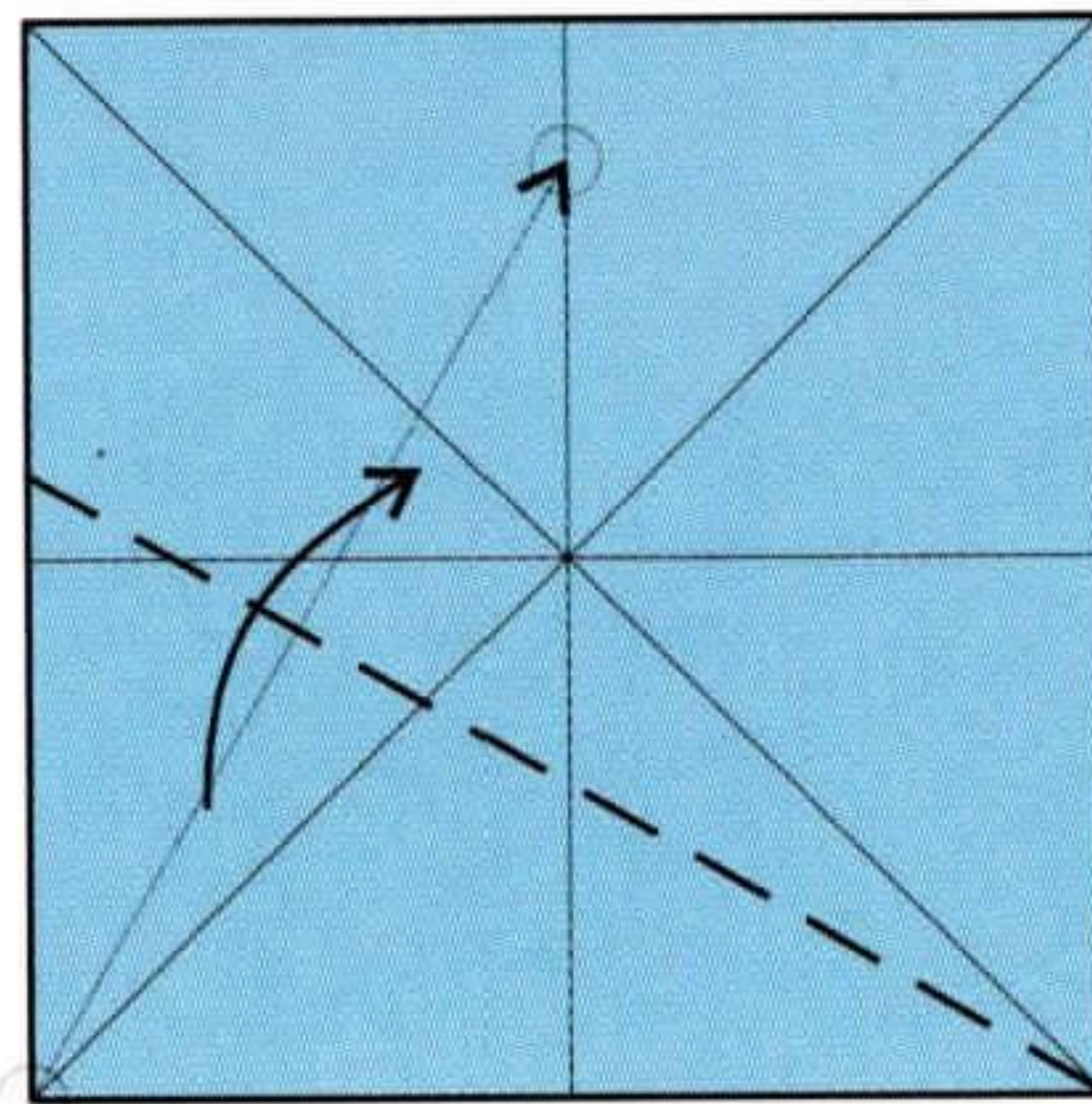

- 2 Fold the lower left corner up to touch the vertical middle crease.

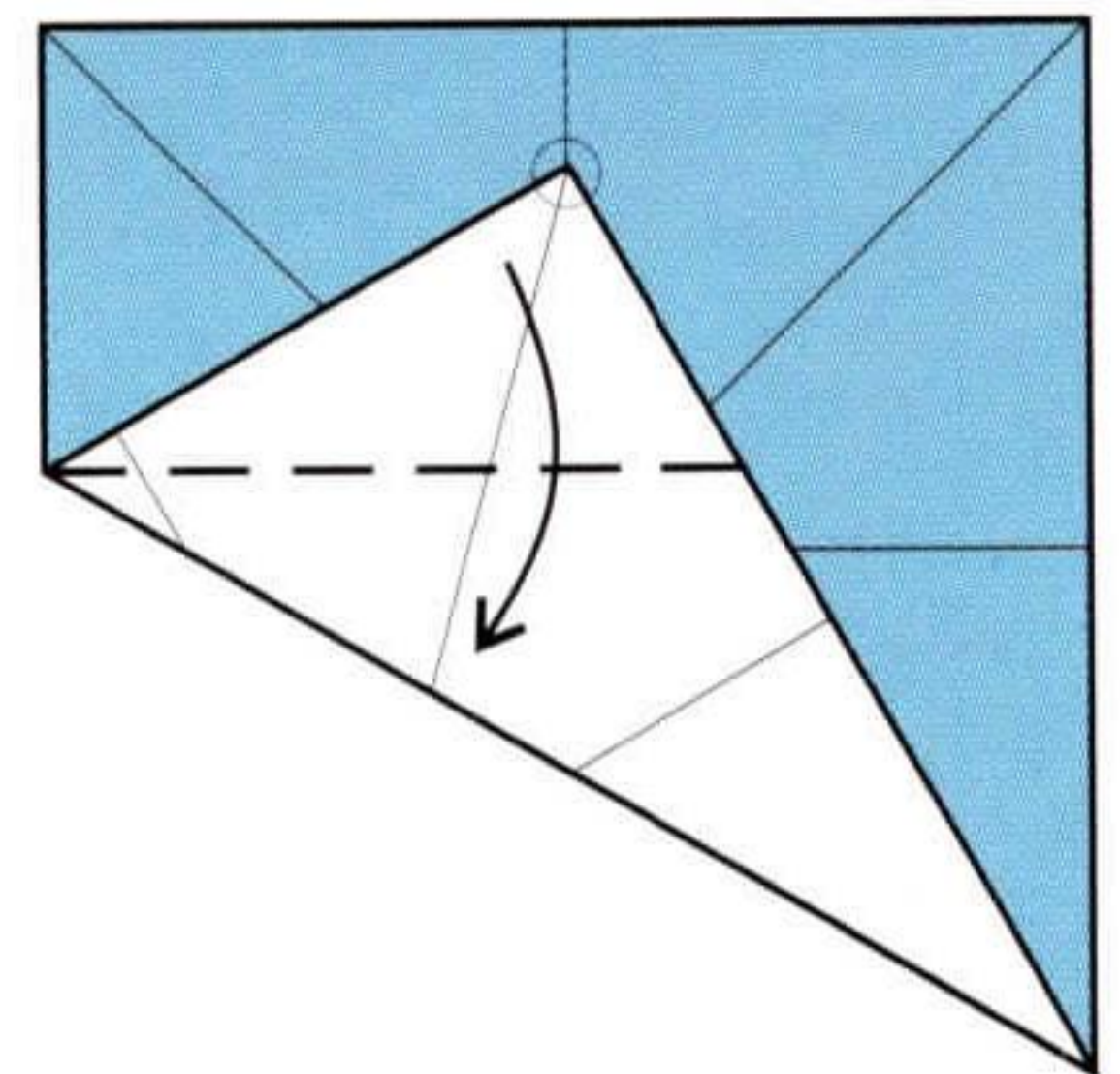

- 3 Fold the corner down so that its edge touches the adjacent folded edge.

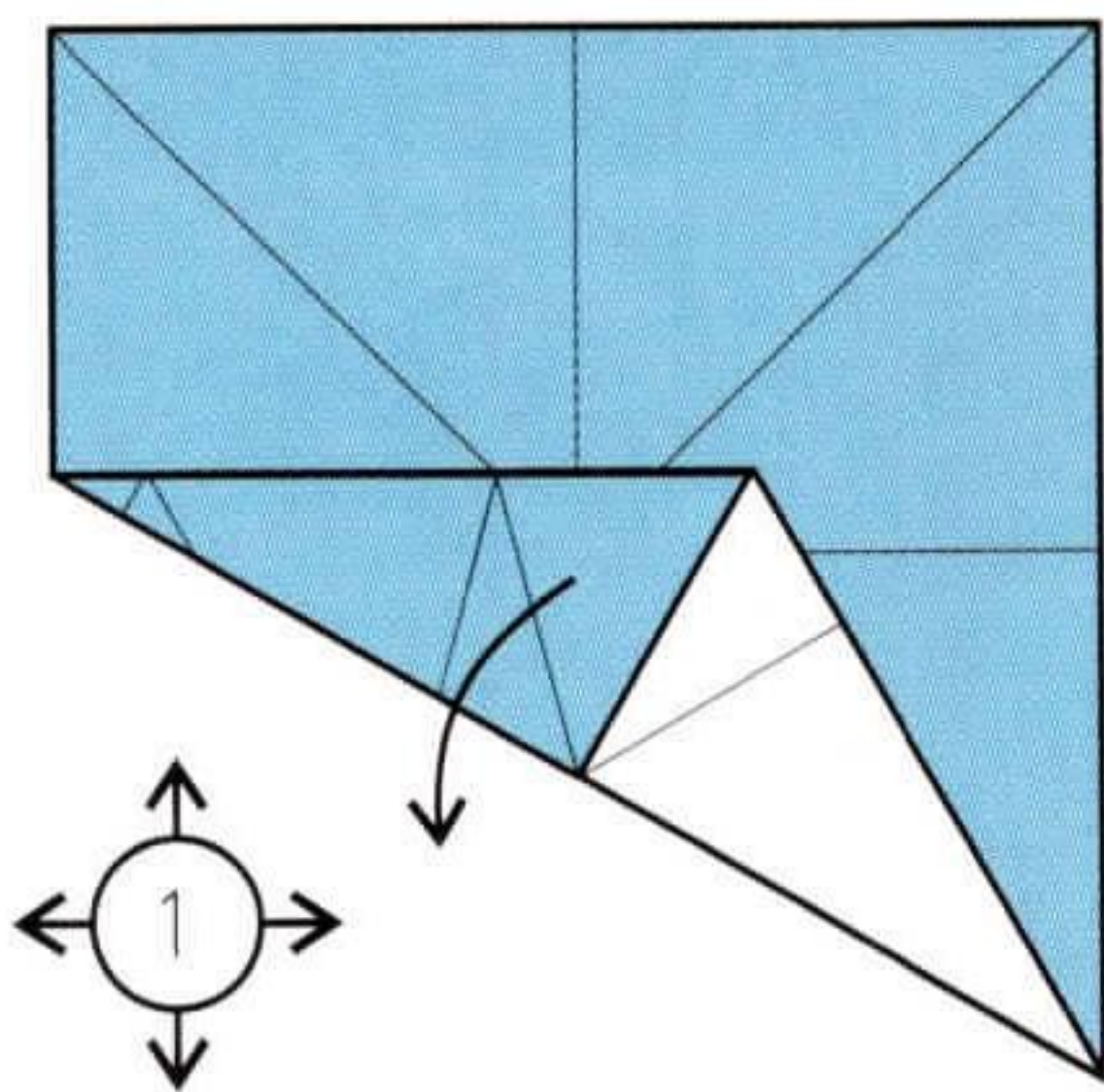

- 4 Unfold the corner.

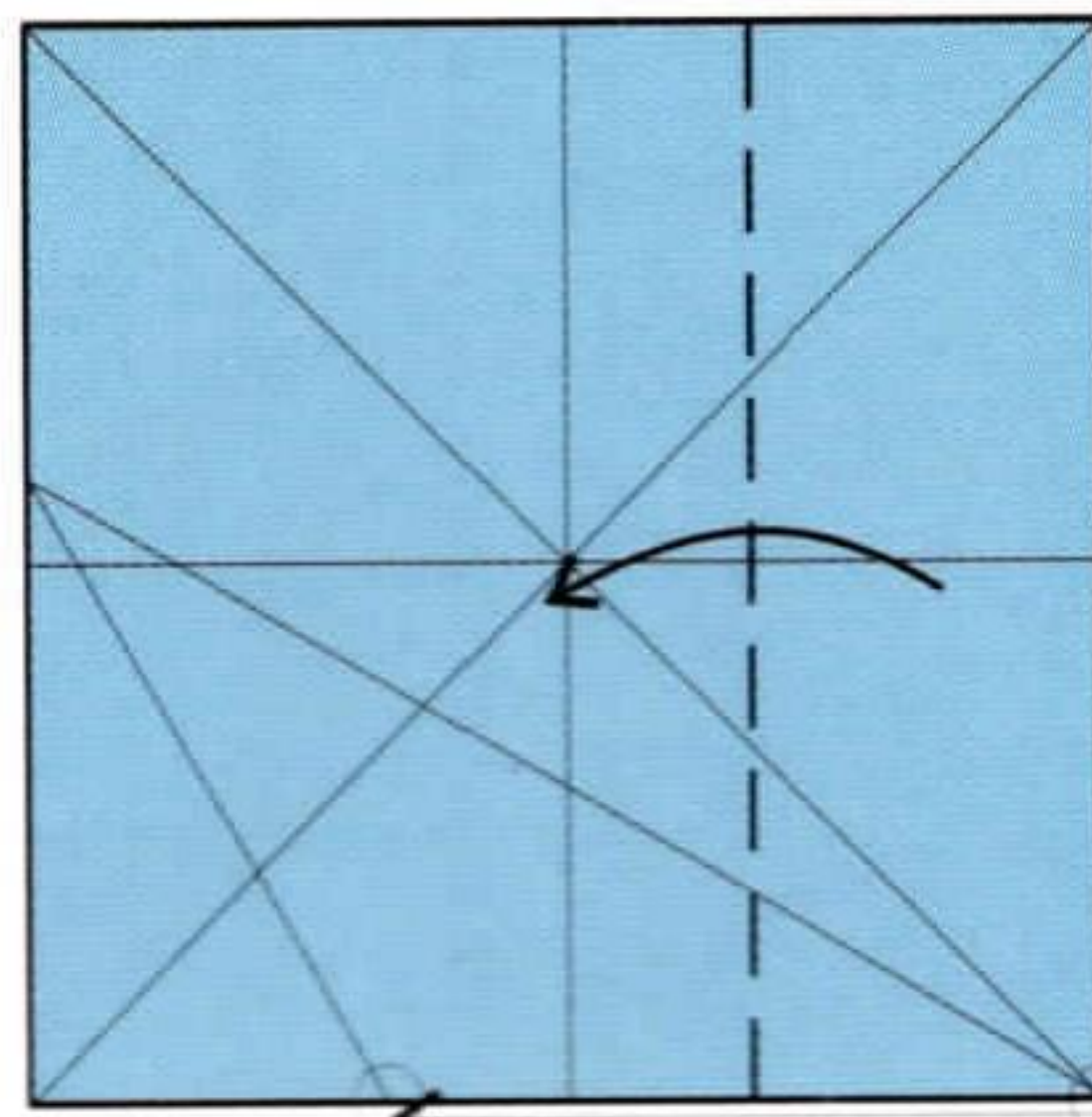

- 5 Fold the edge in to the crease made previously.

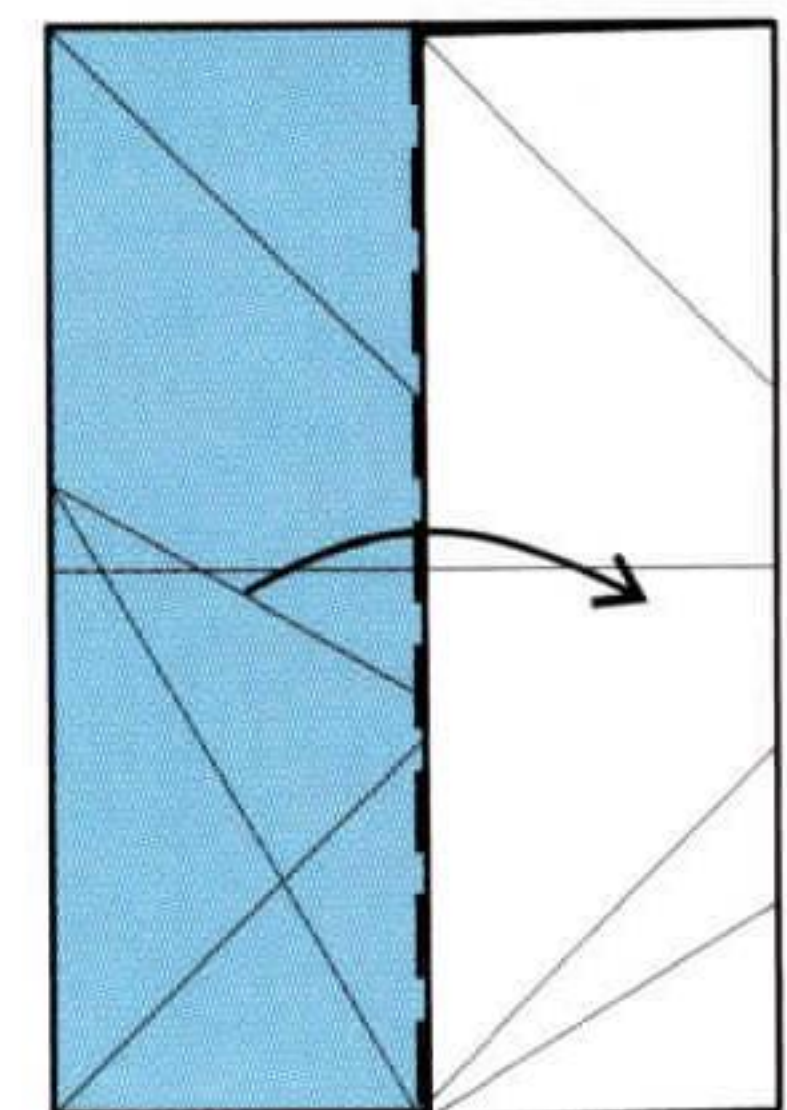

- 6 Fold the edge over again.

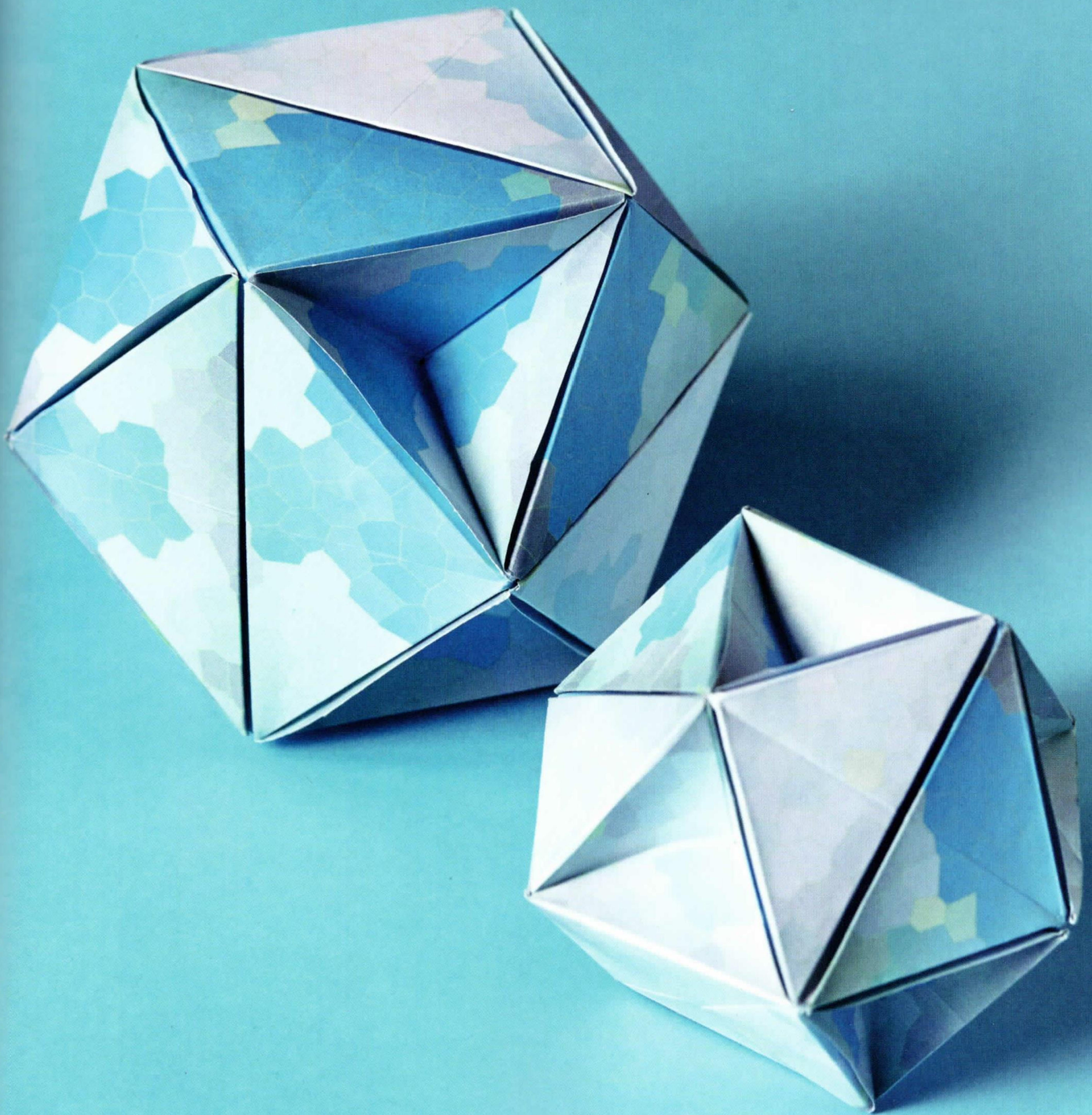

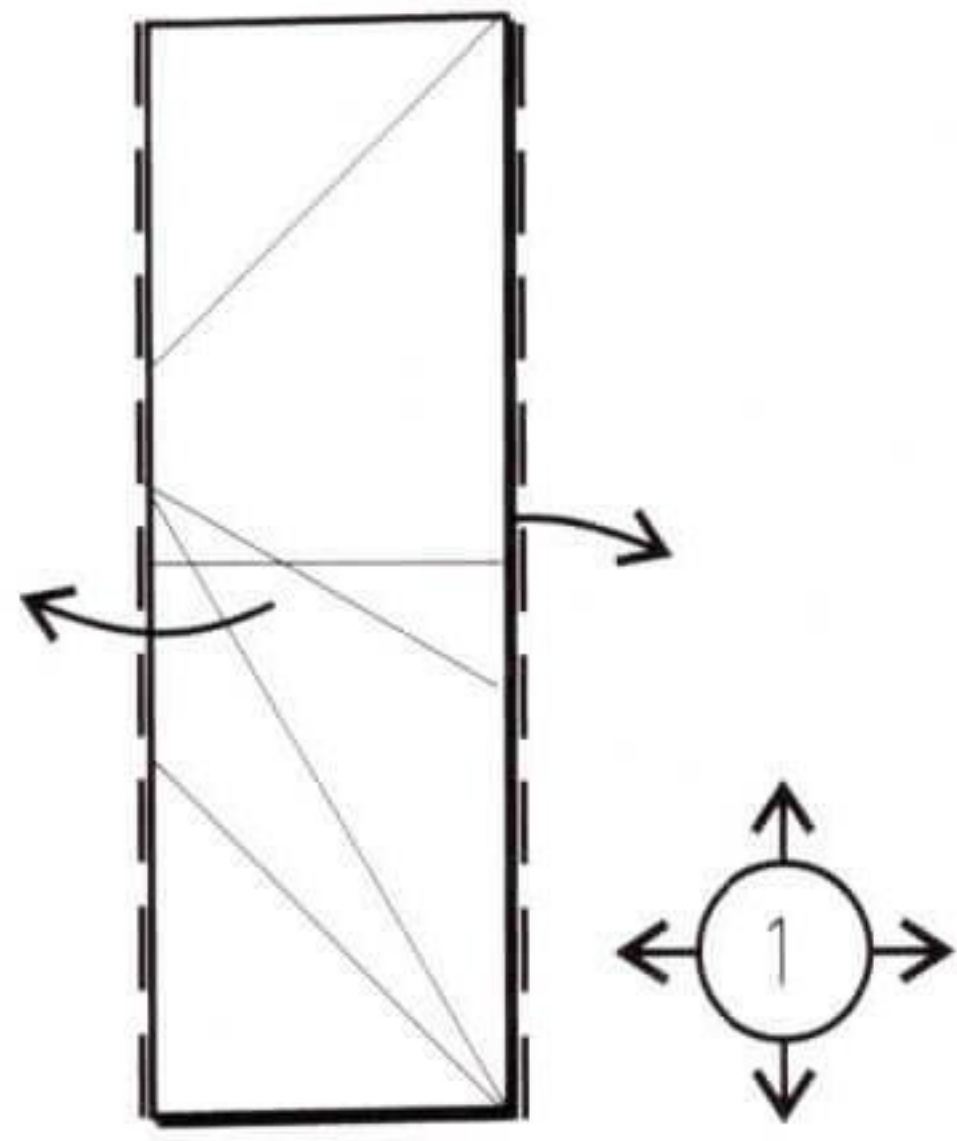

7 Unfold back to a square.

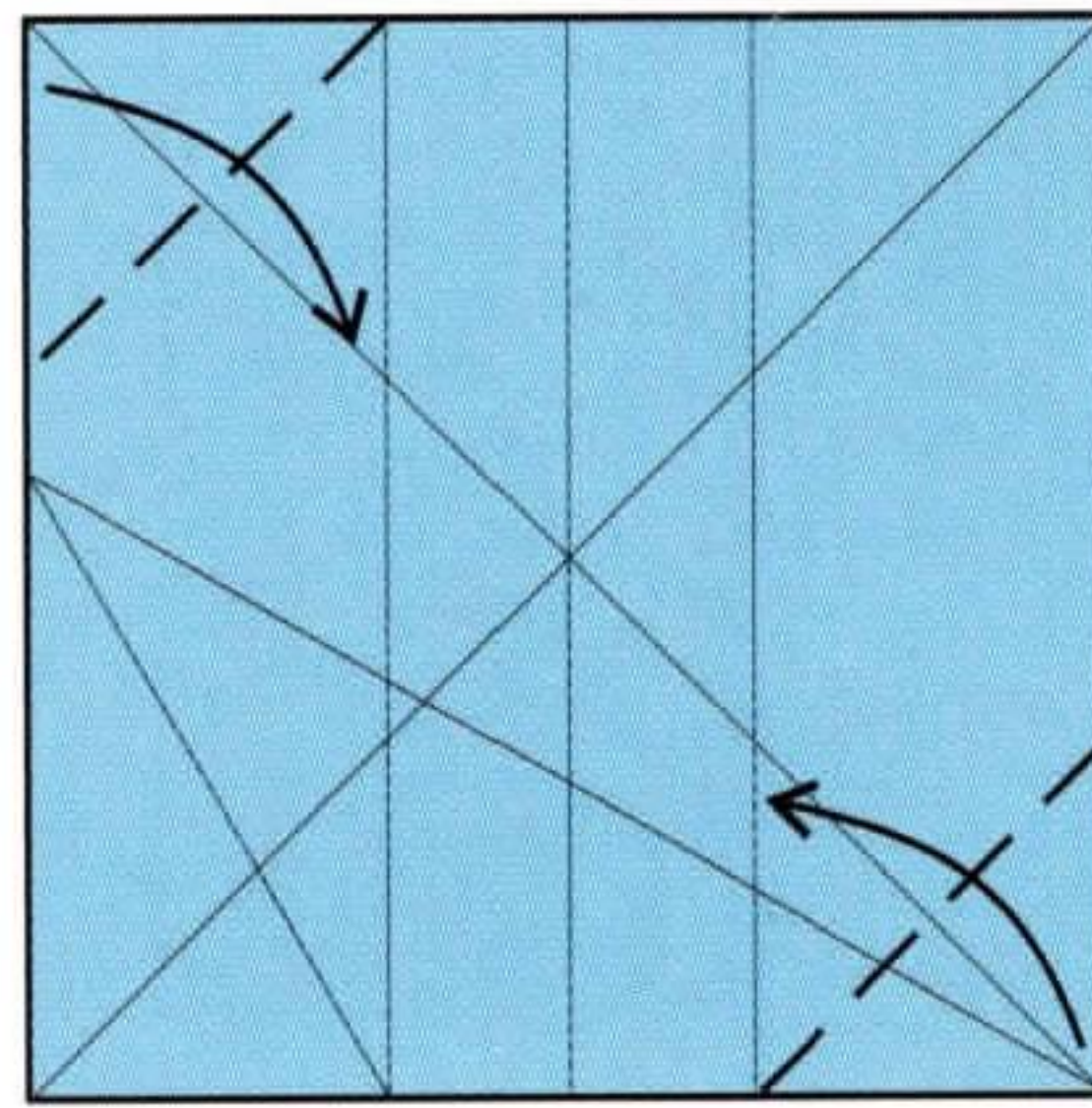

8 Fold corners in to touch the creases made previously.

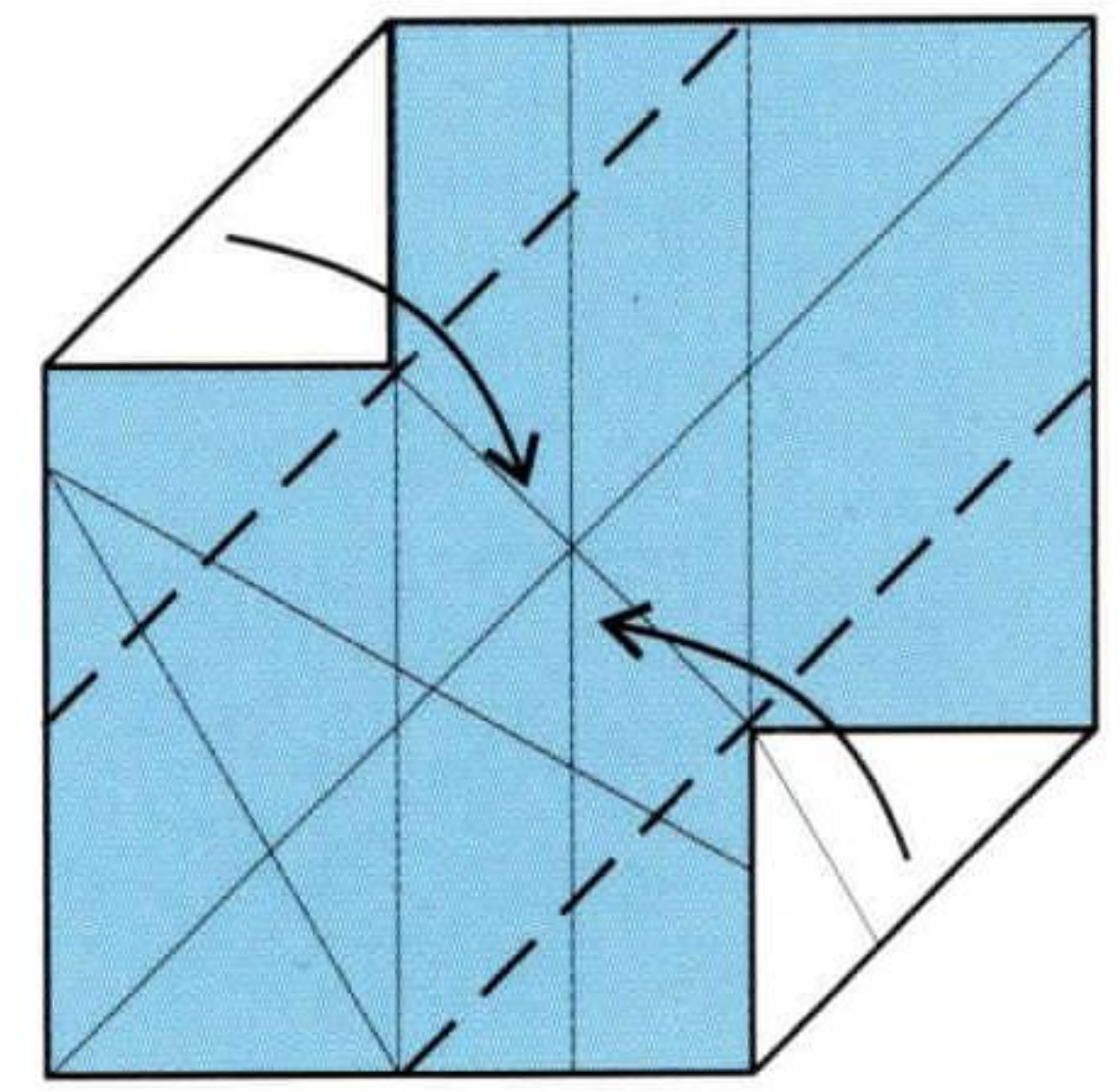

9 Fold the edges in again.

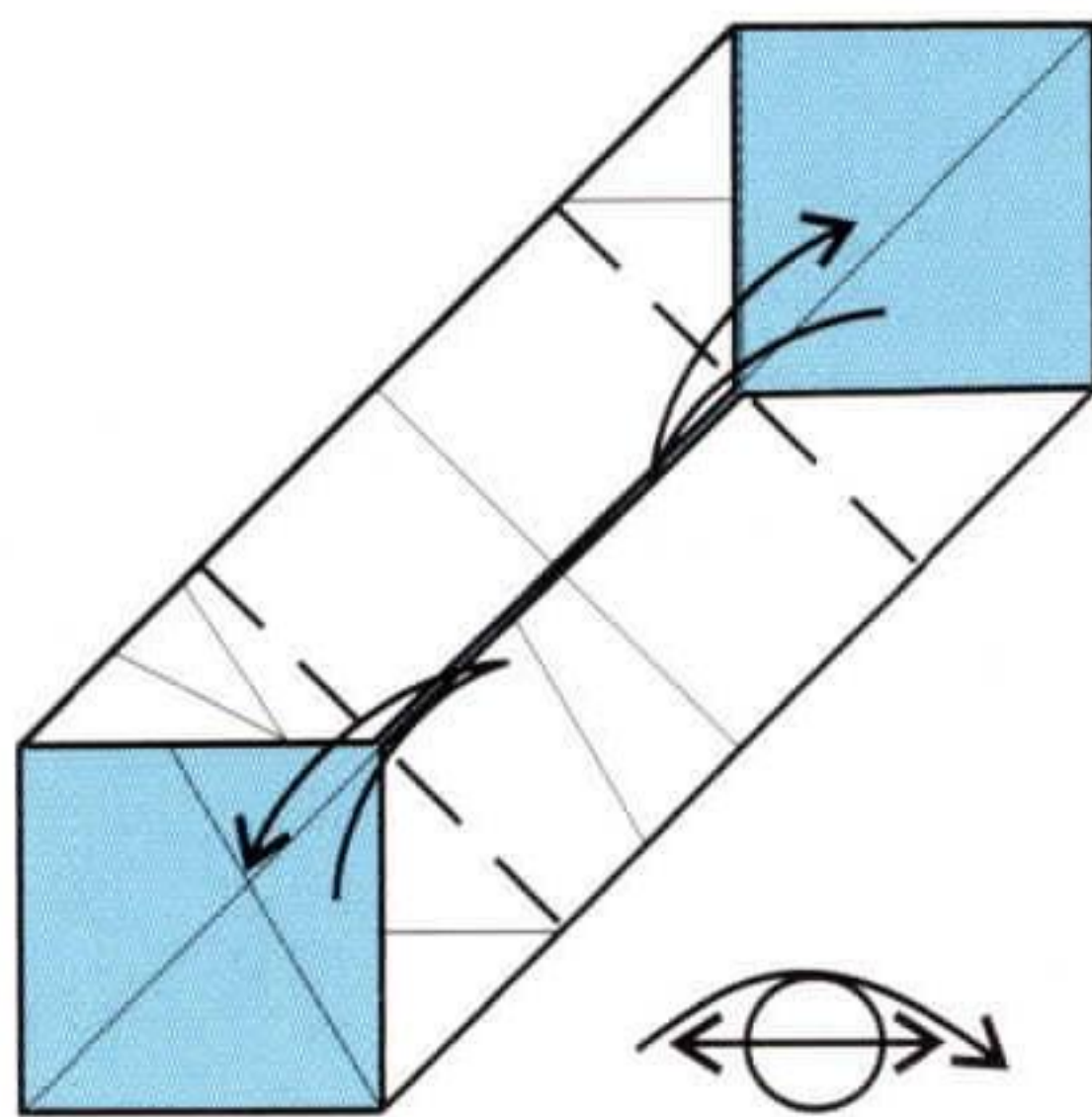

10 Fold and unfold where indicated. Then turn the model over left to right.

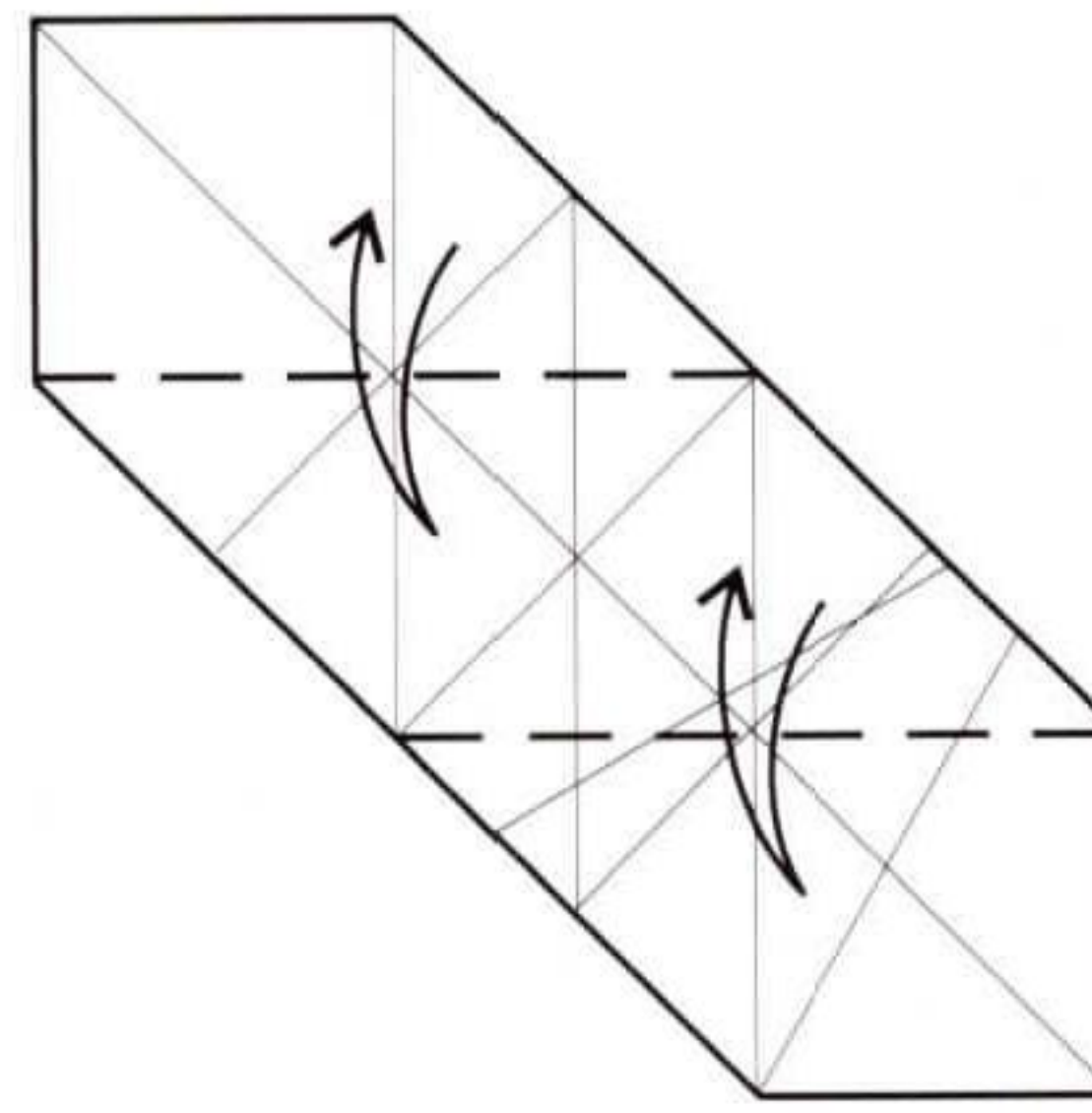

11 Fold and unfold the paper where indicated.

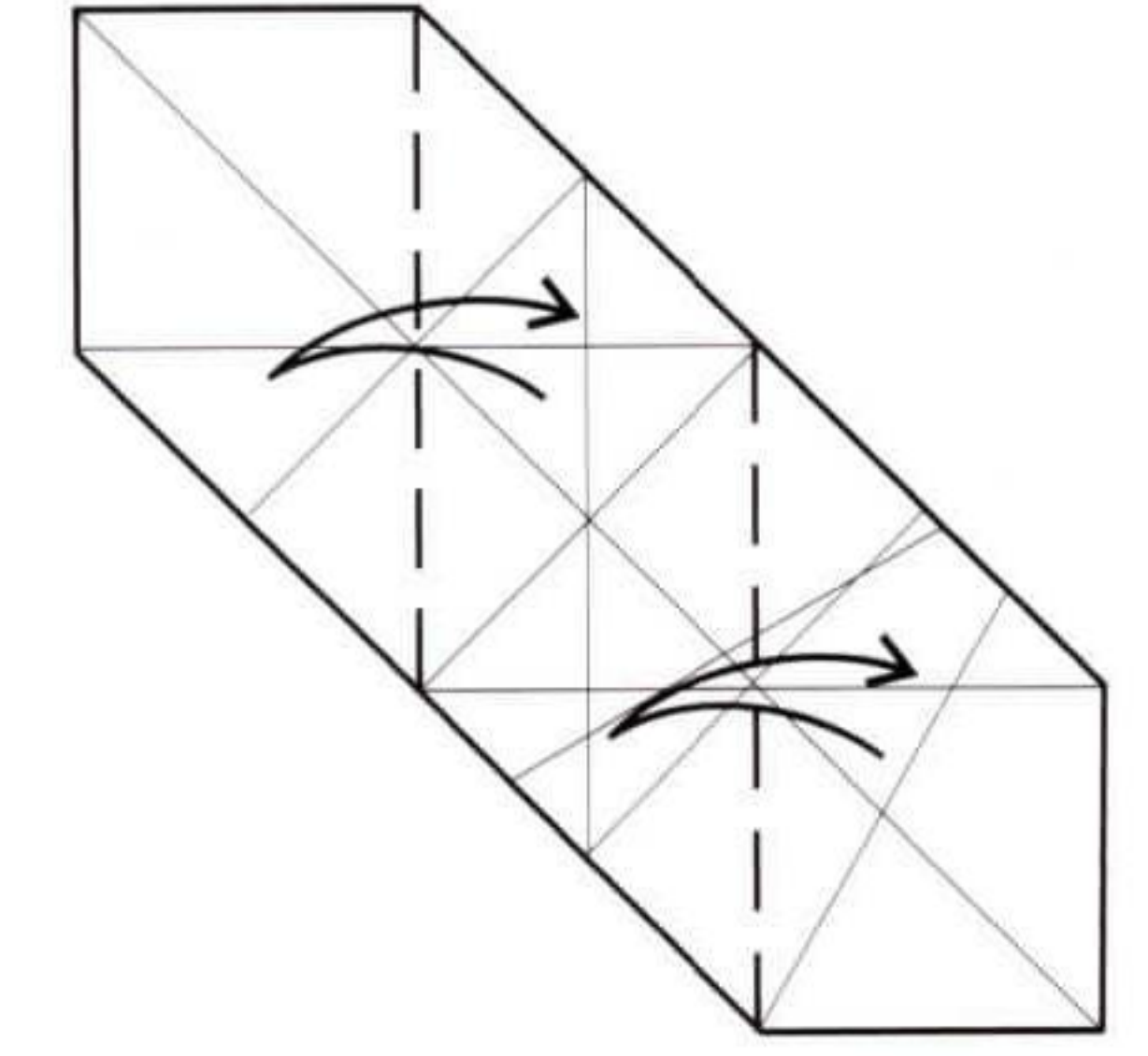

12 Fold and unfold the paper where indicated.

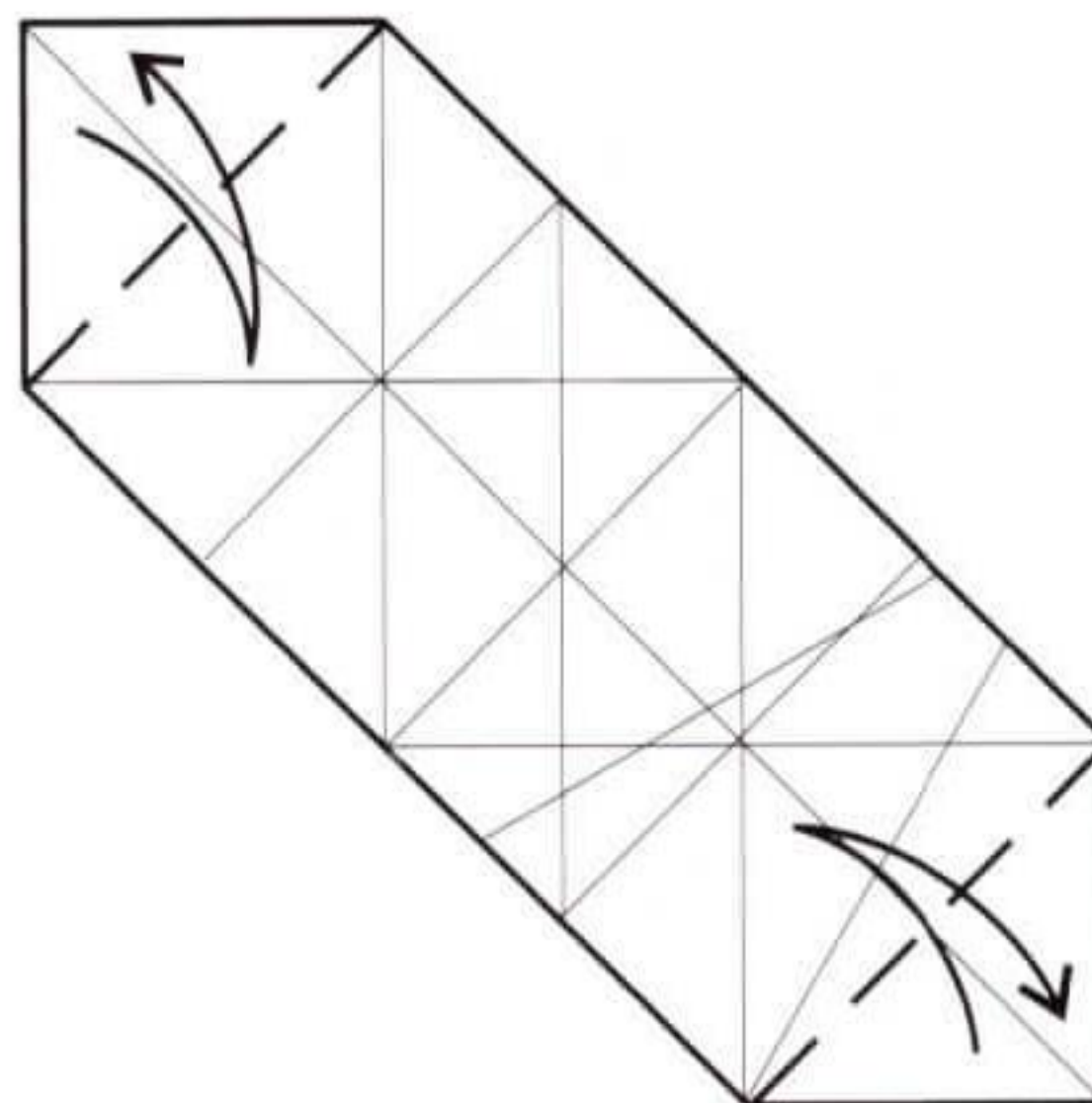

13 Fold the corners in and out again.

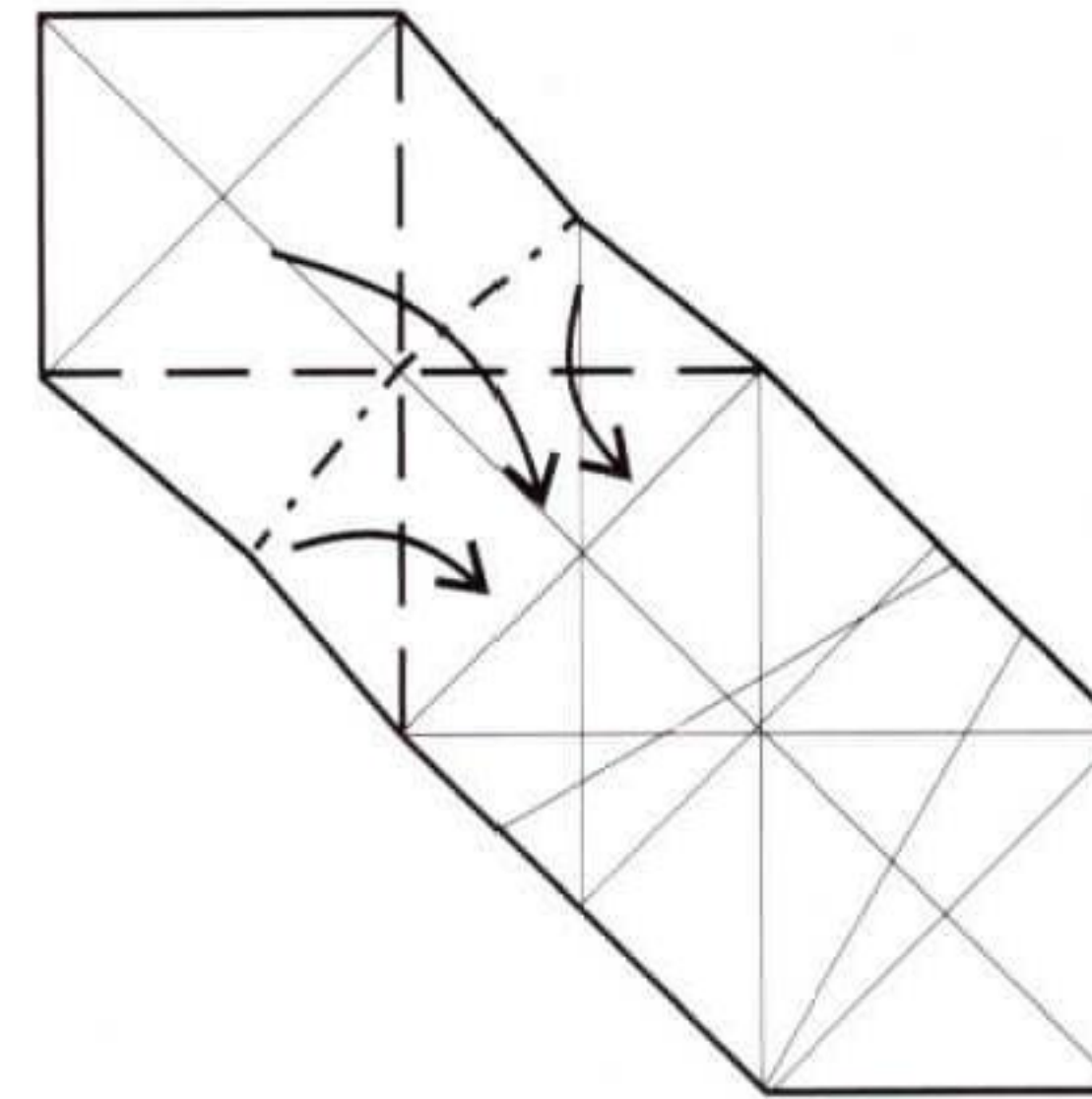

14 Fold the outer section in along the creases made previously.

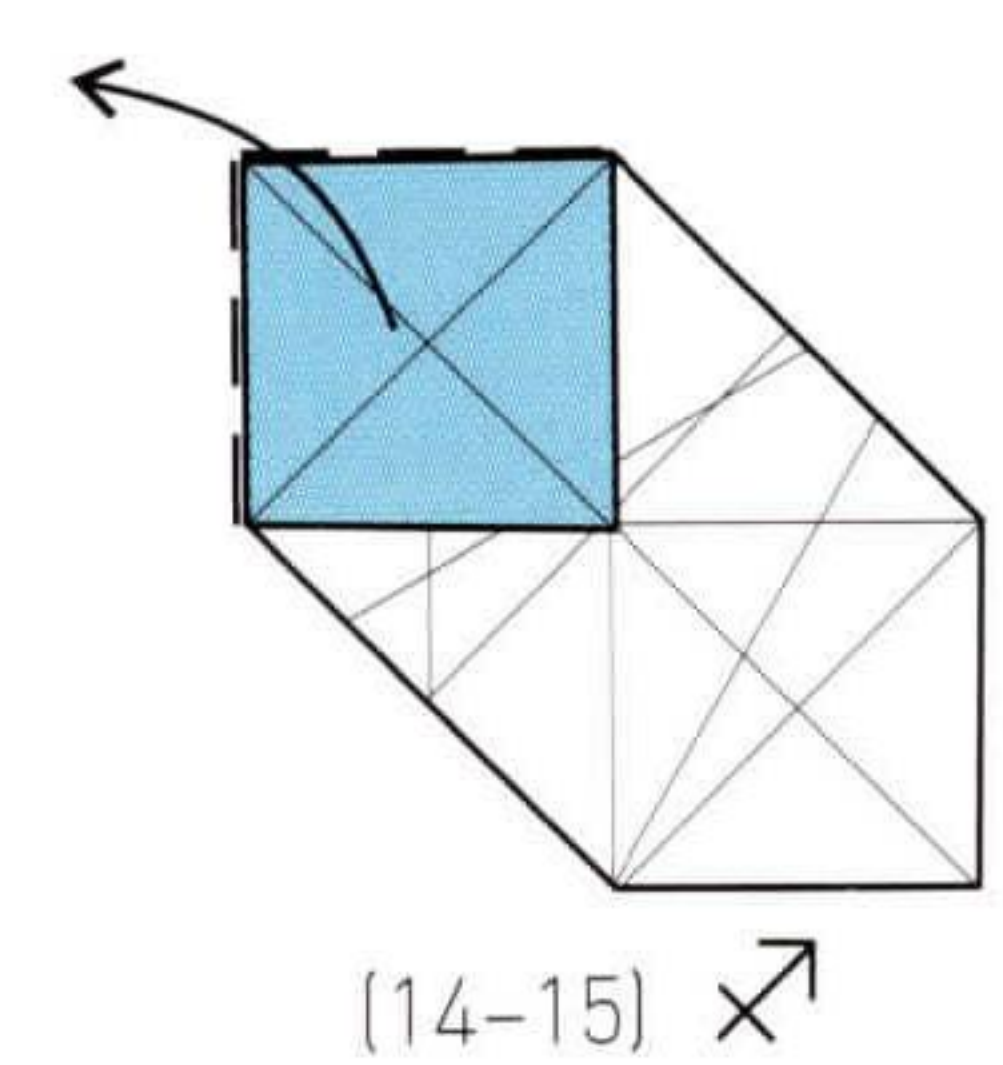

15 Unfold the section. Then repeat steps 14 to 15 on the other end to complete one of the units. Make five more.

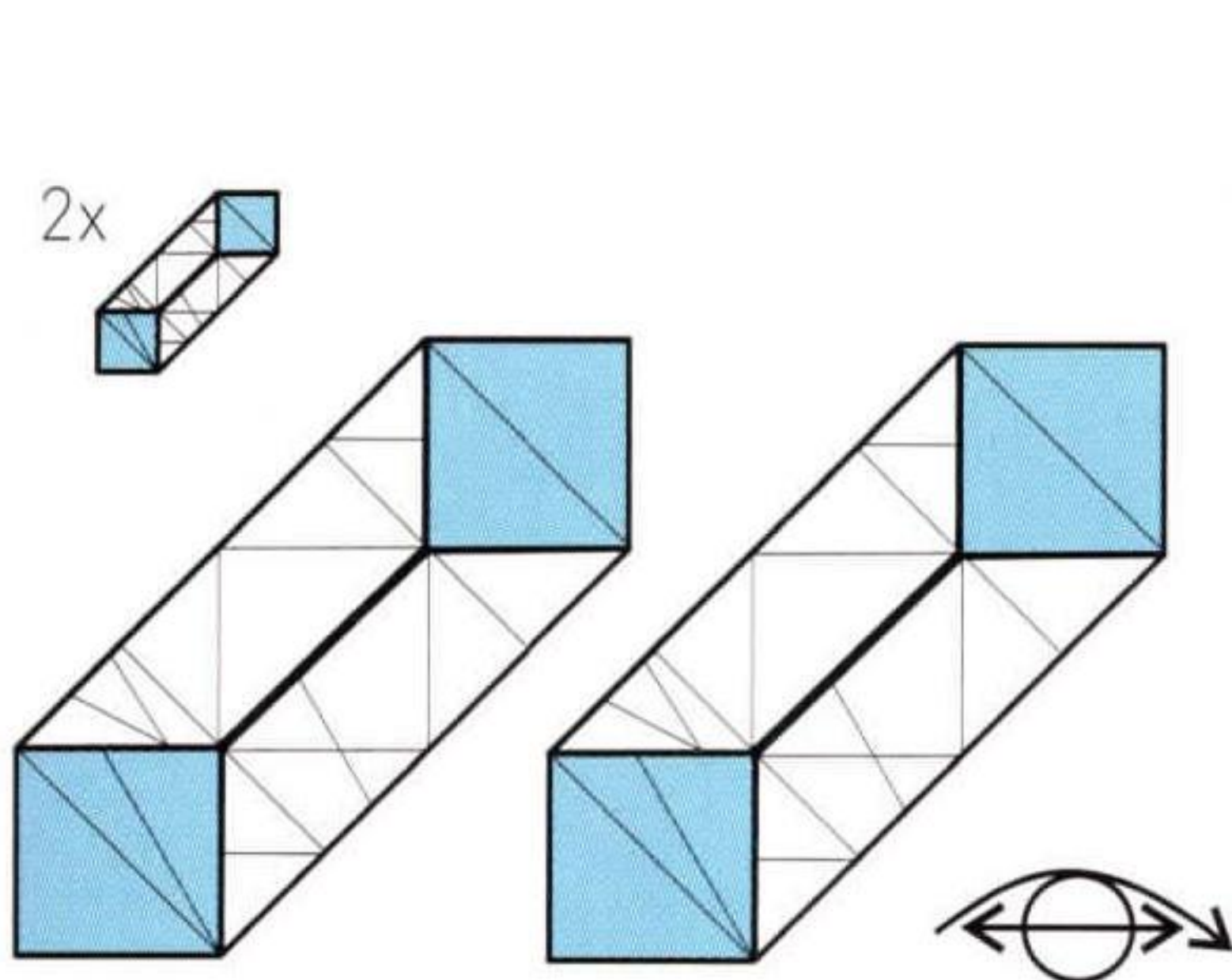

16 Start with two units, then turn one of the units over left to right.

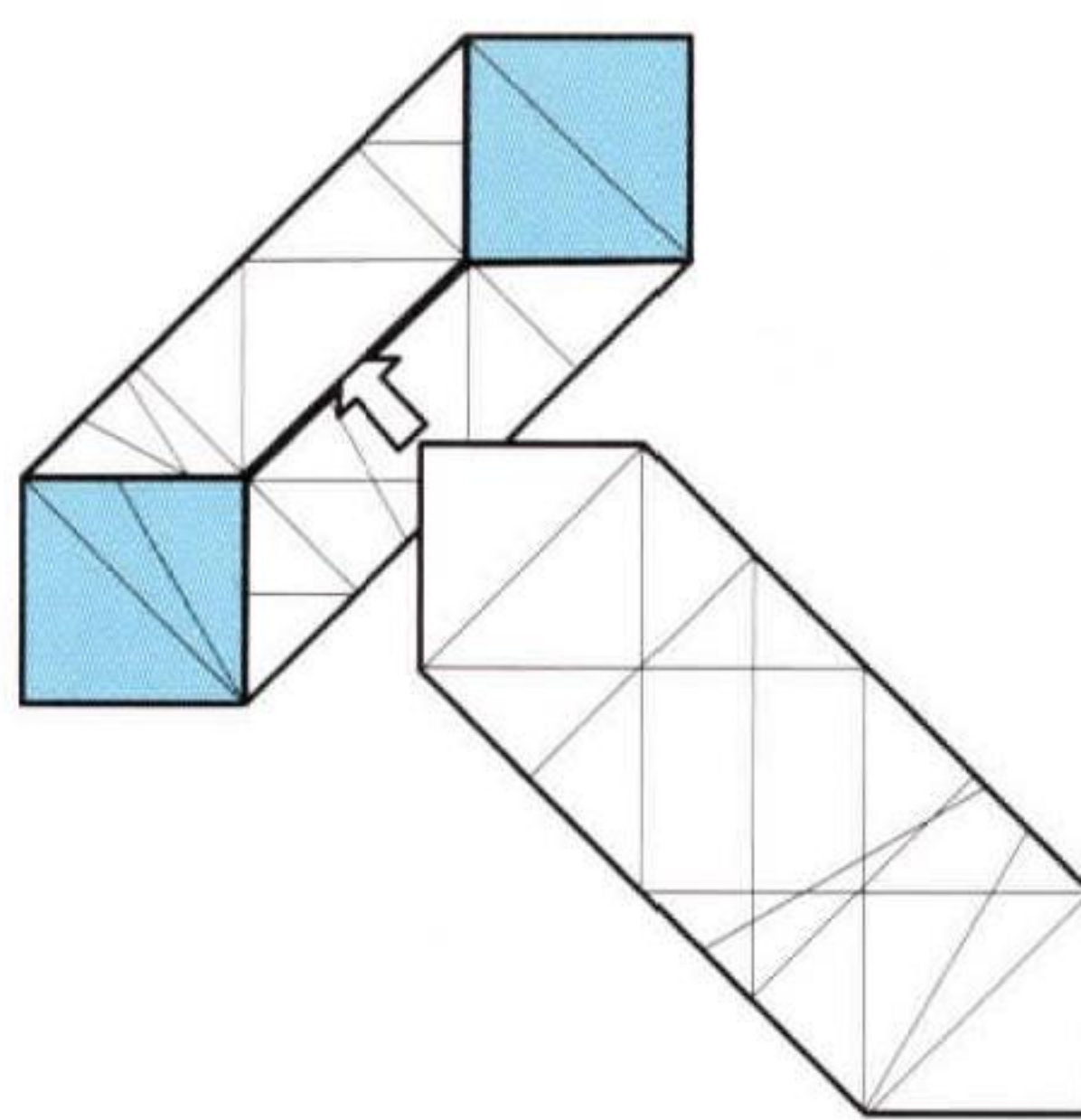

17 Insert the corner of one unit into a pocket in the other.

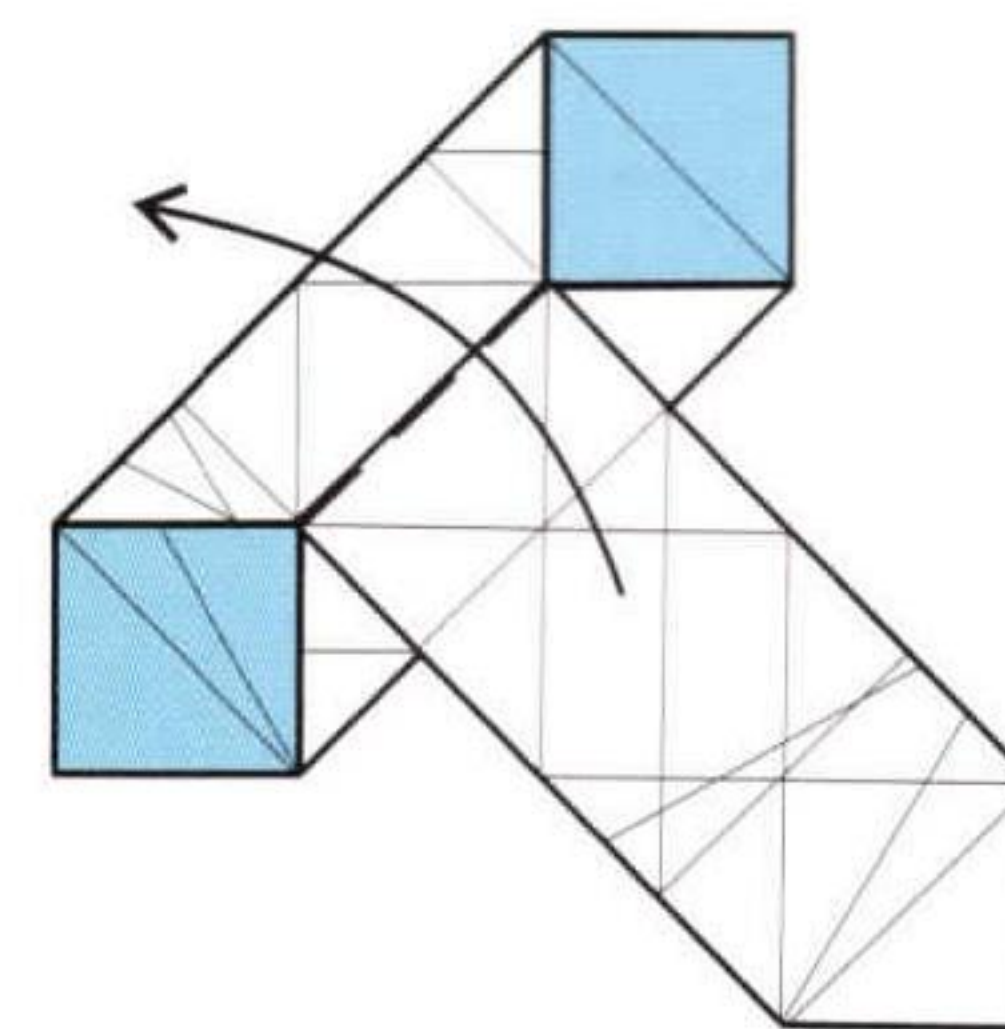

18 Fold the unit back over.

ADDING A THIRD UNIT

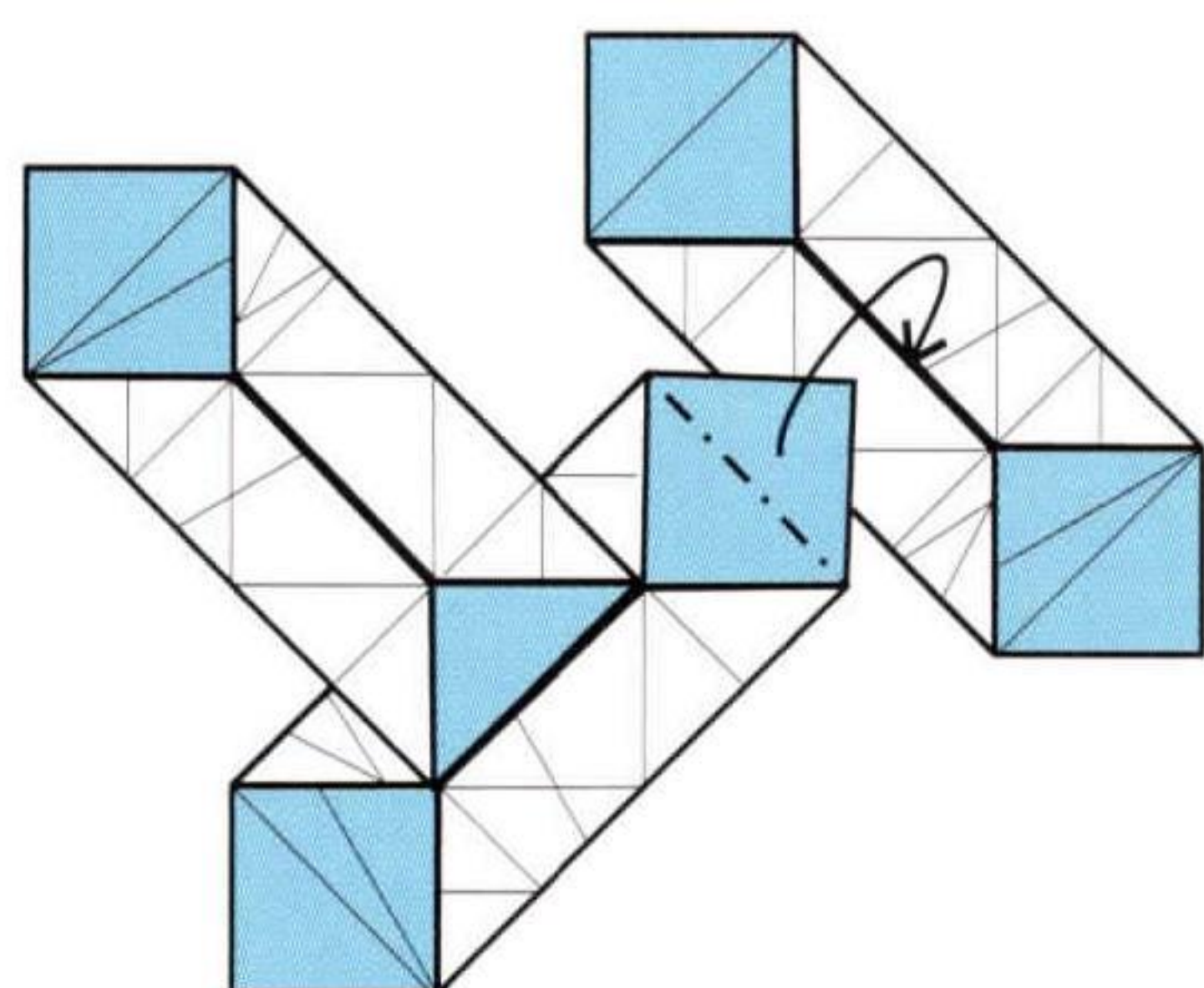

19 The principle is that each corner will fold into a pocket. This shows a corner folding into a third unit.

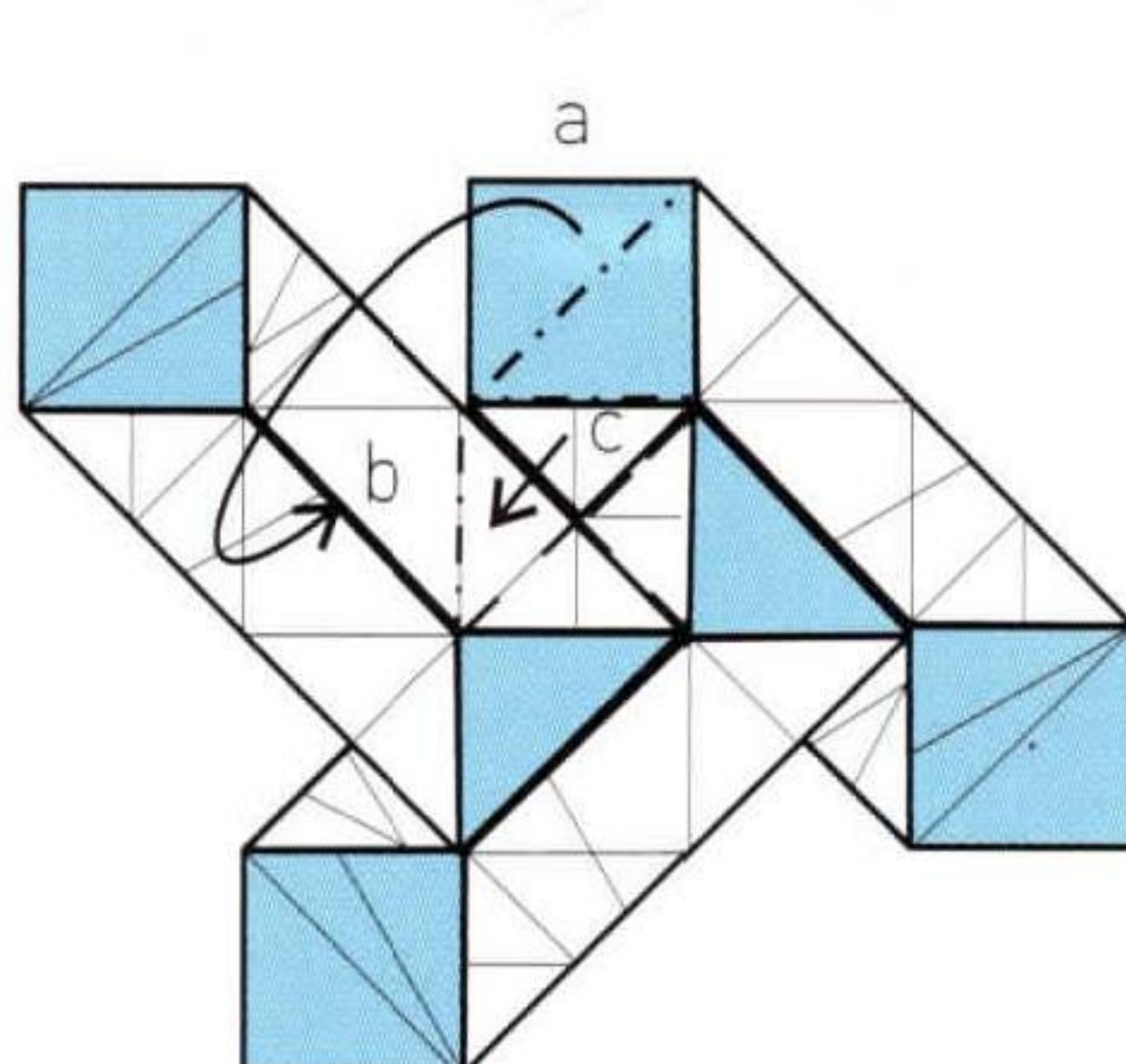

20 Tuck the corner (a) into the pocket (b). This will cause the layer (c) to fold over the adjacent section in unit (b).

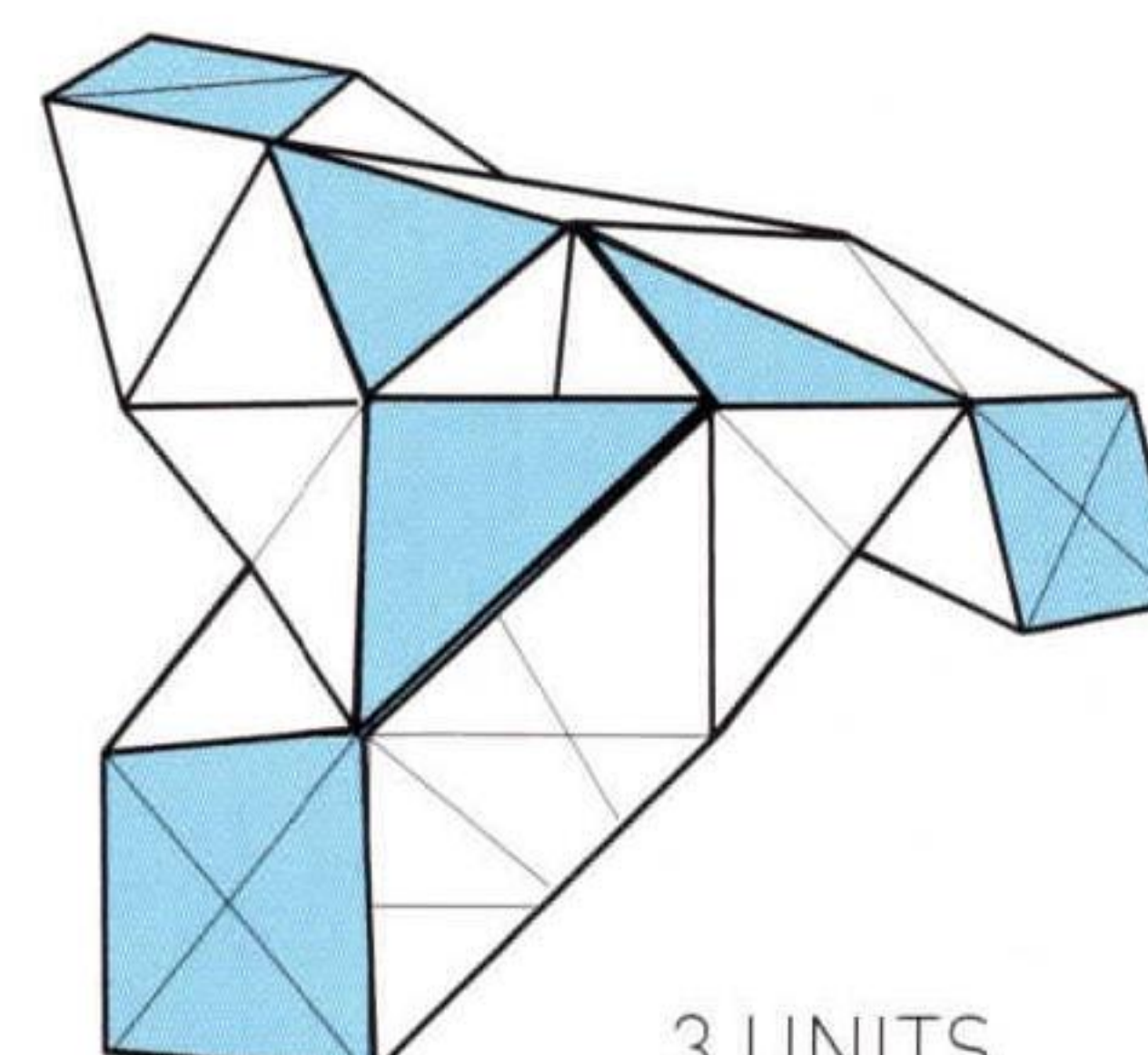

3 UNITS

21 This shows three units combined.

SIX-UNIT ASSEMBLY

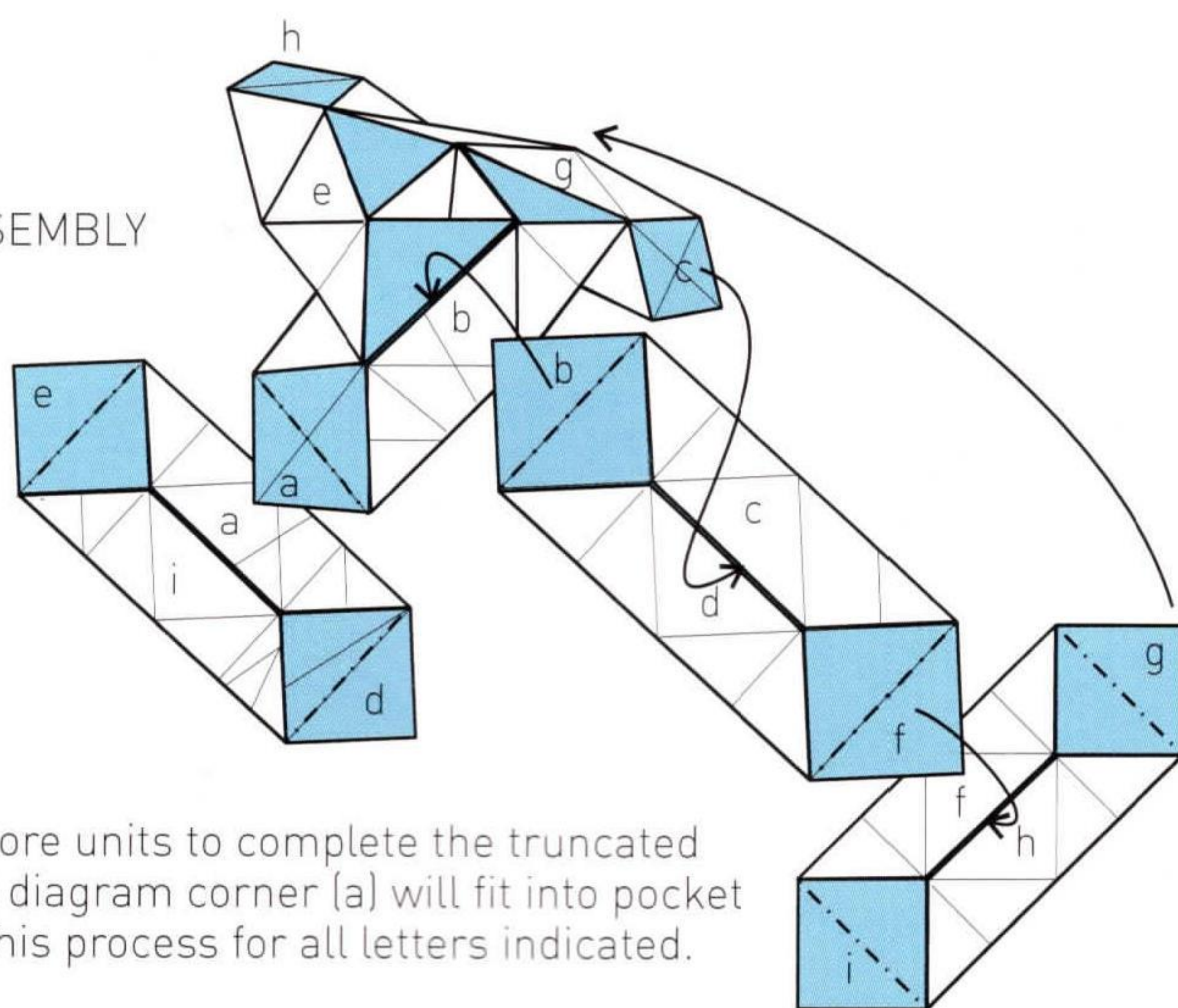

22 Add three more units to complete the truncated cube. In this diagram corner (a) will fit into pocket (a). Repeat this process for all letters indicated.

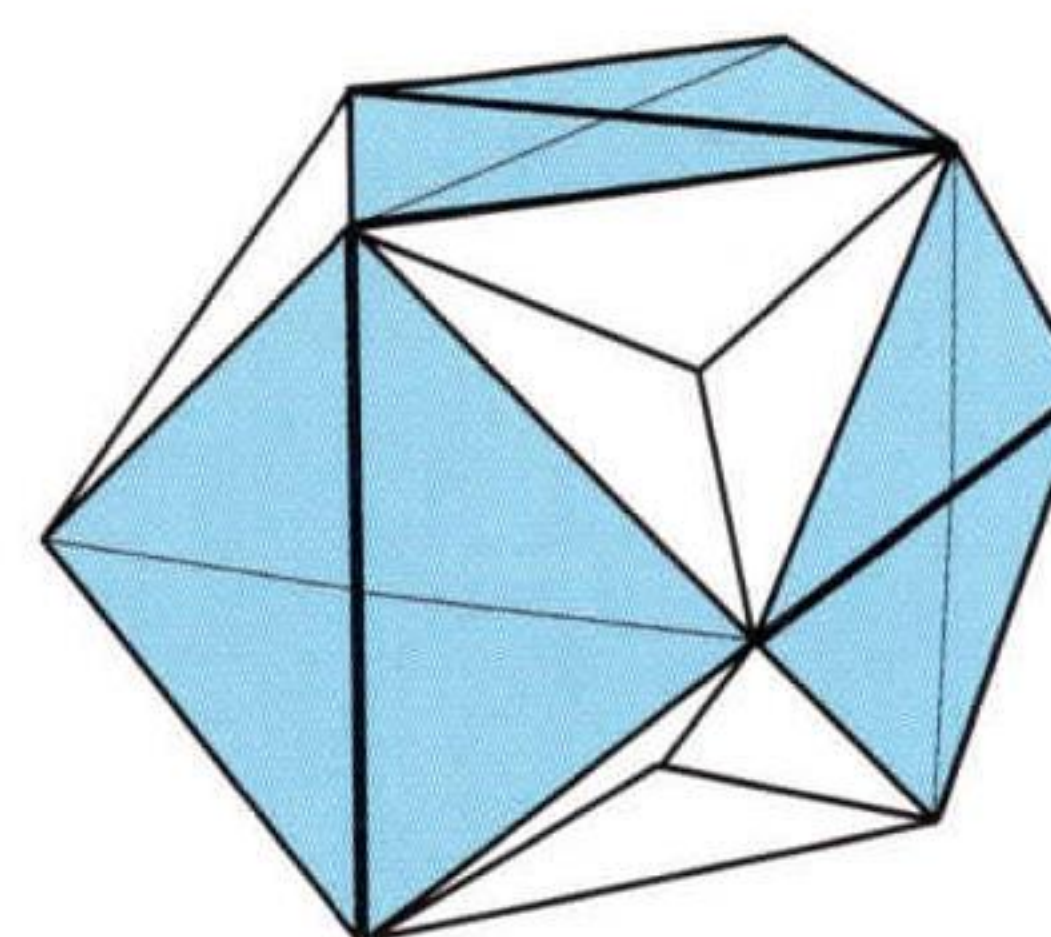

23 Complete.

Hexahedron

**

This modular project makes a series of regular solids that can be made from similarly folded units. The units fit together by inserting the tab of one into a pocket in another. The hexahedron is made up of three units.

18 X 18CM (7 X 7IN)

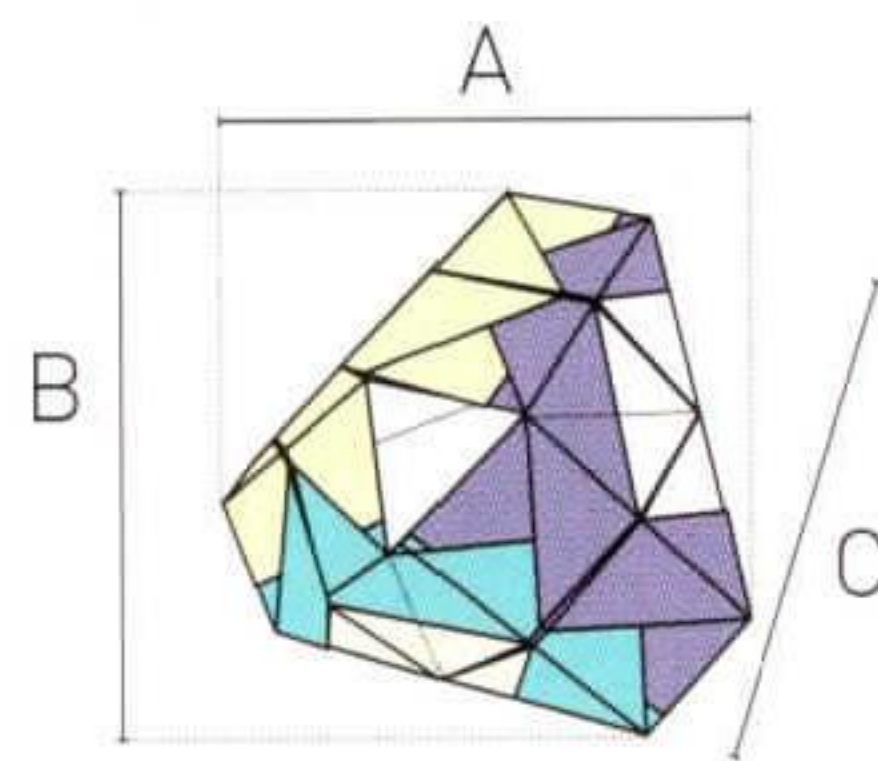
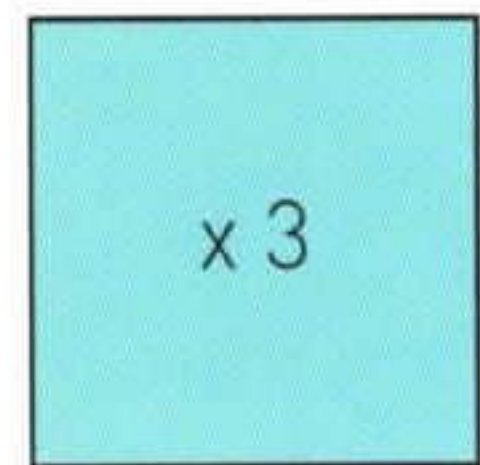

A	9cm	[3½in]
B	9cm	[3½in]
C	6cm	[2½in]

THE MODEL IS MADE FROM THREE UNITS. FOR EACH UNIT START WITH A SQUARE, COLOURED SIDE UP.

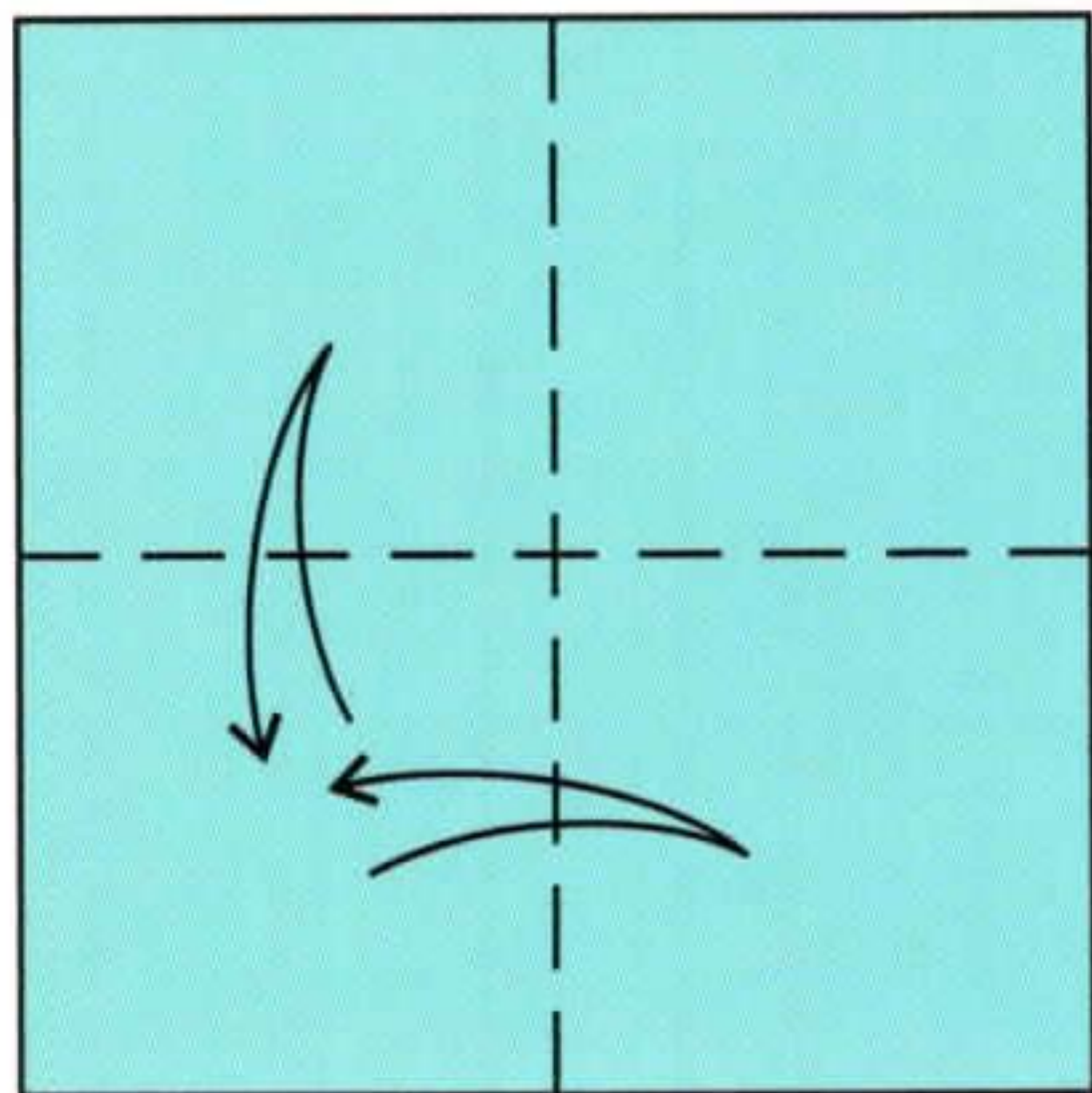

- 1 Fold and unfold the square in half lengthwise along both axes.

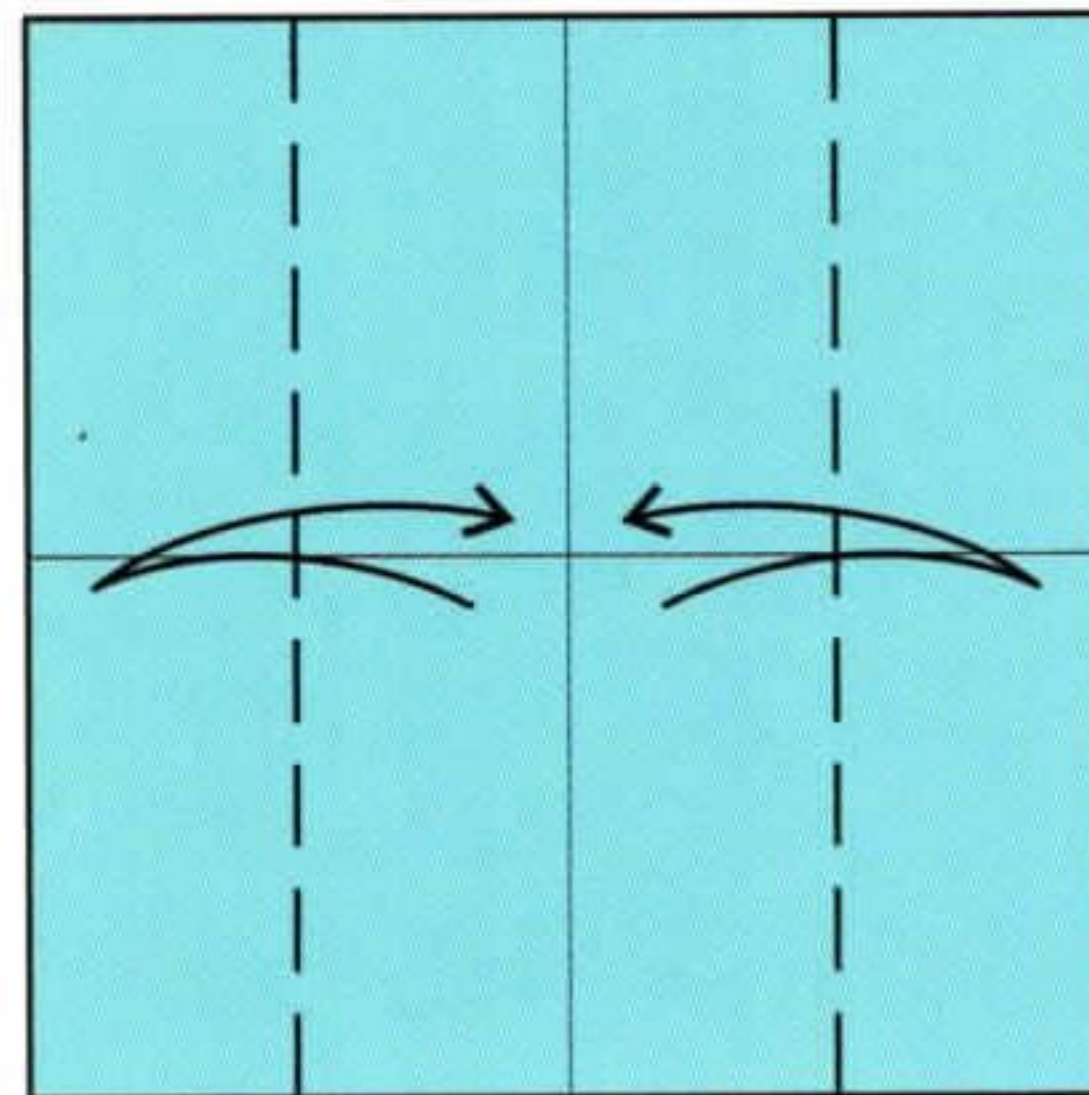

- 2 Fold and unfold the edges in to the middle.

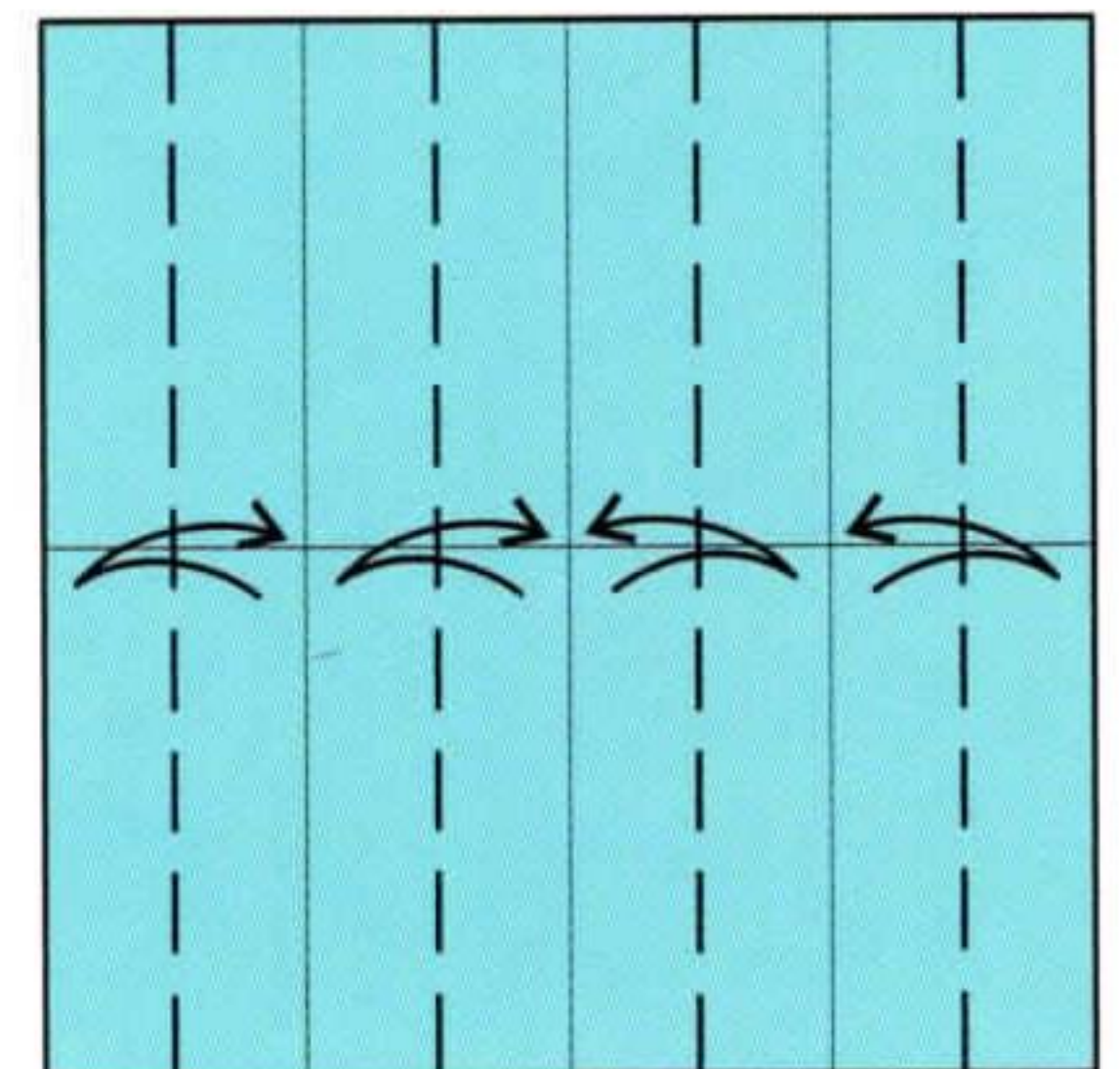

- 3 Fold and unfold between the creases made previously.

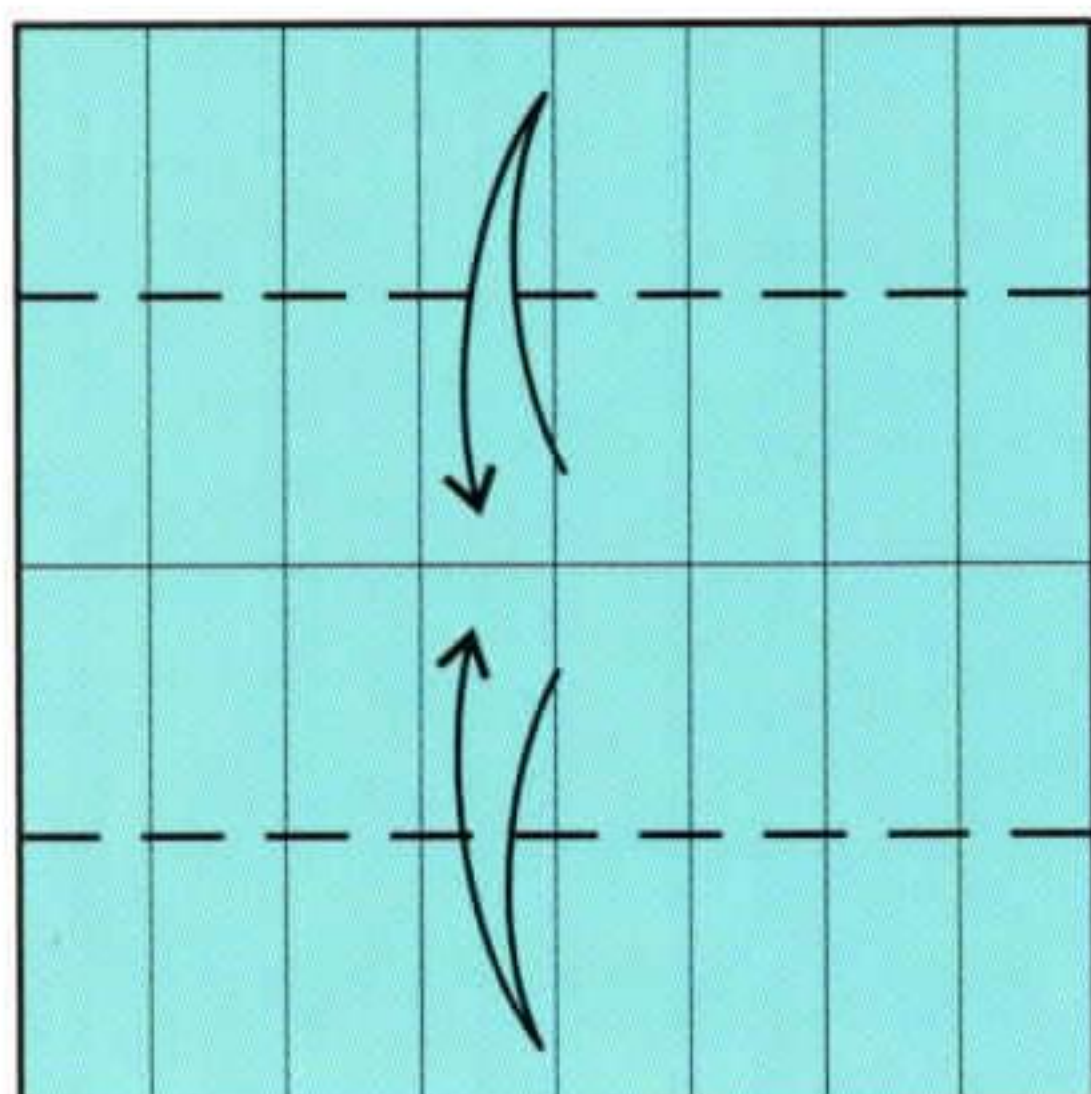

- 4 Fold and unfold the outer edges into the middle.

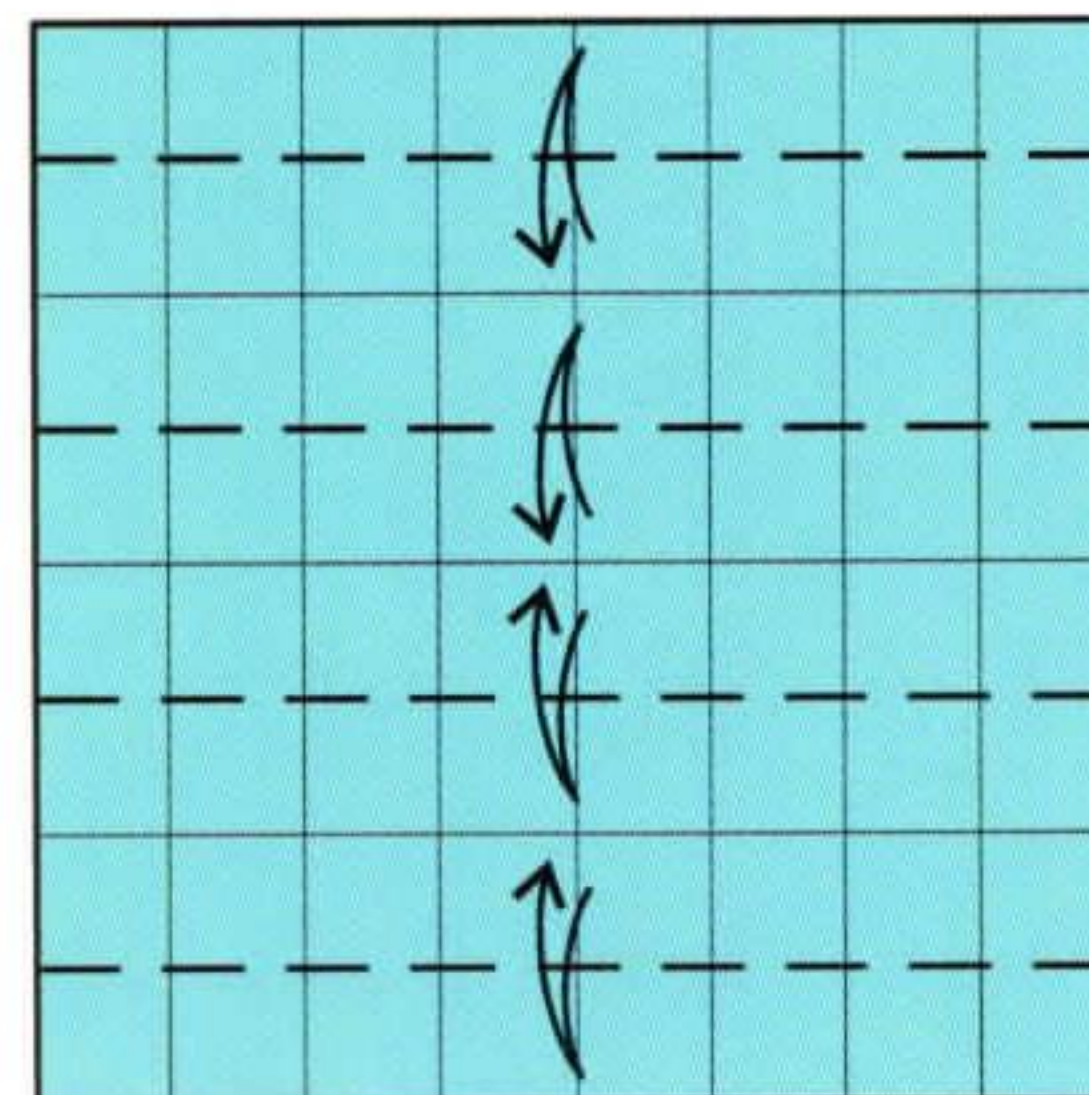

- 5 Fold and unfold between the creases made previously. Then turn the model over left to right.

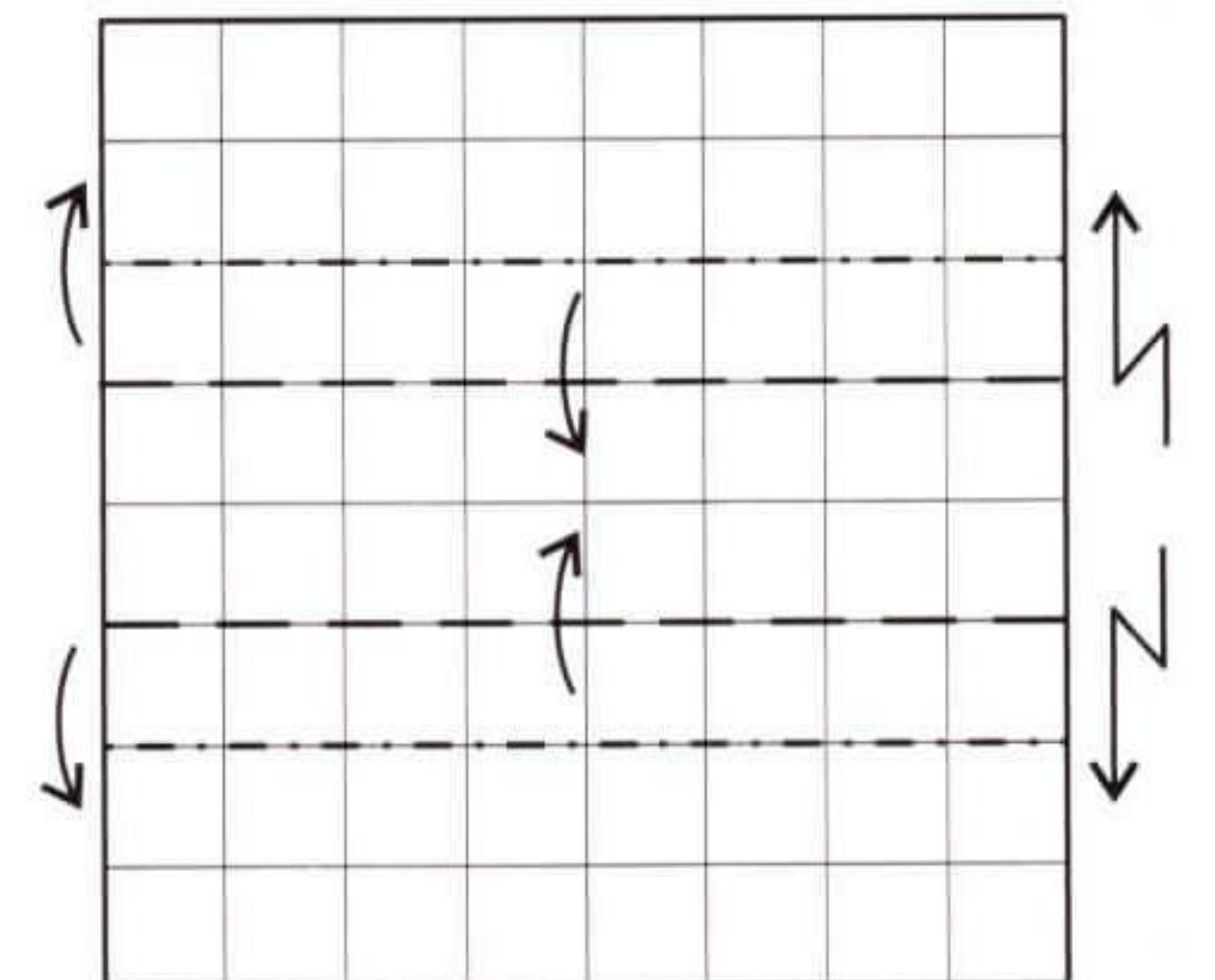
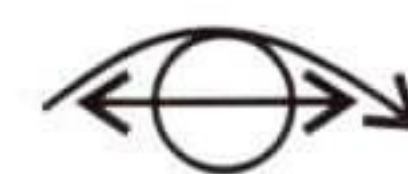

- 6 Fold the outer edges in and out again making two zigzag folds.

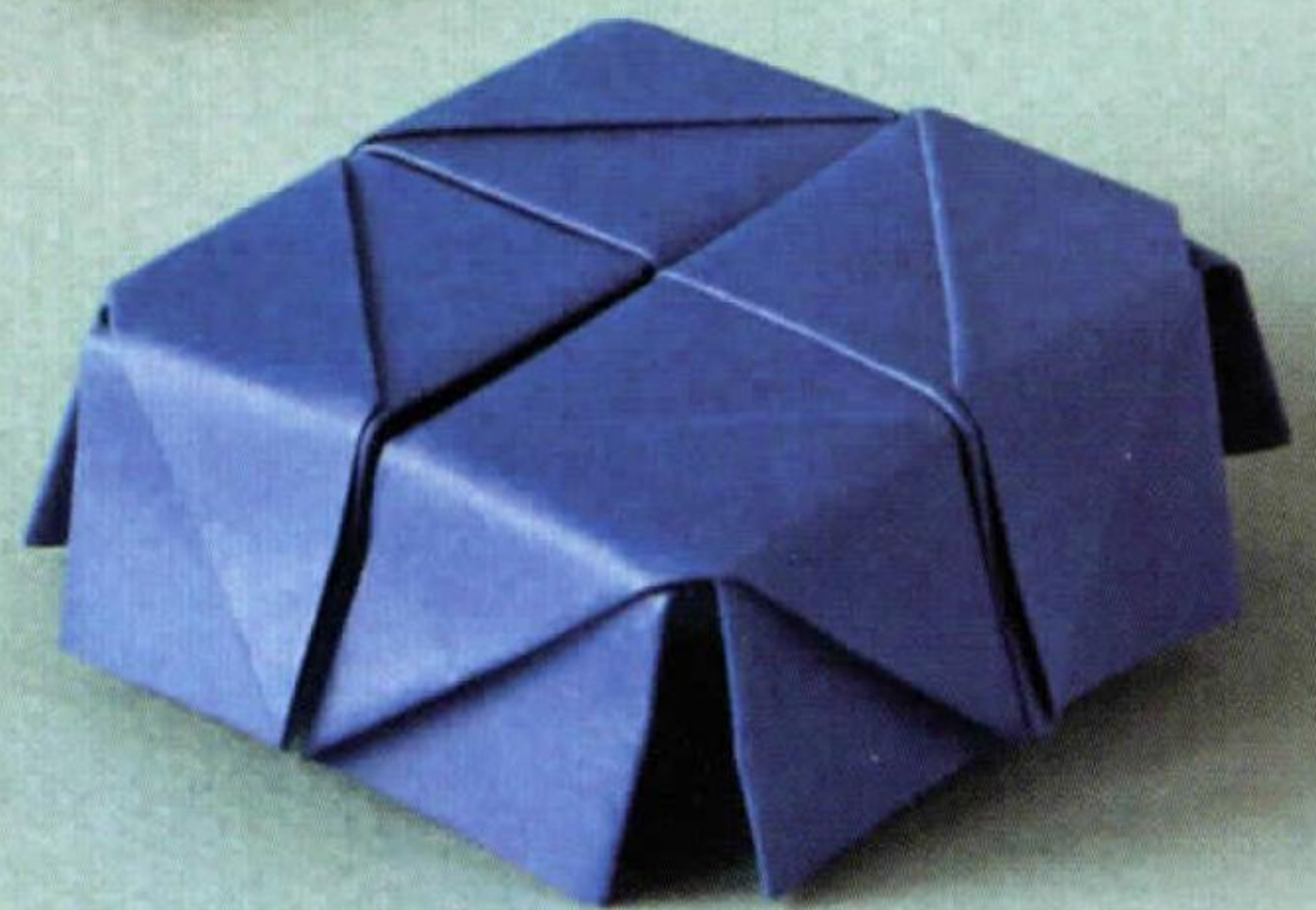
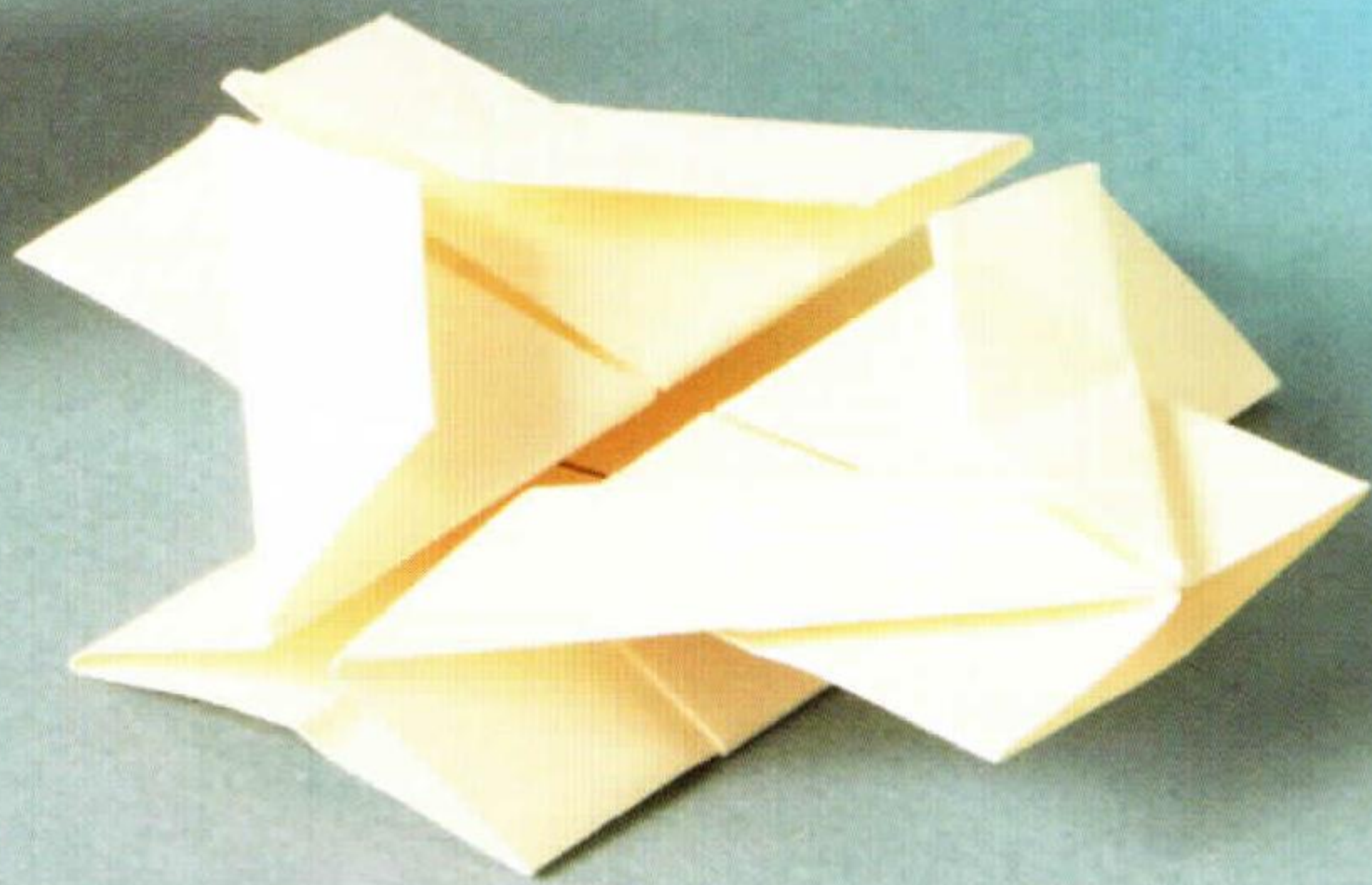
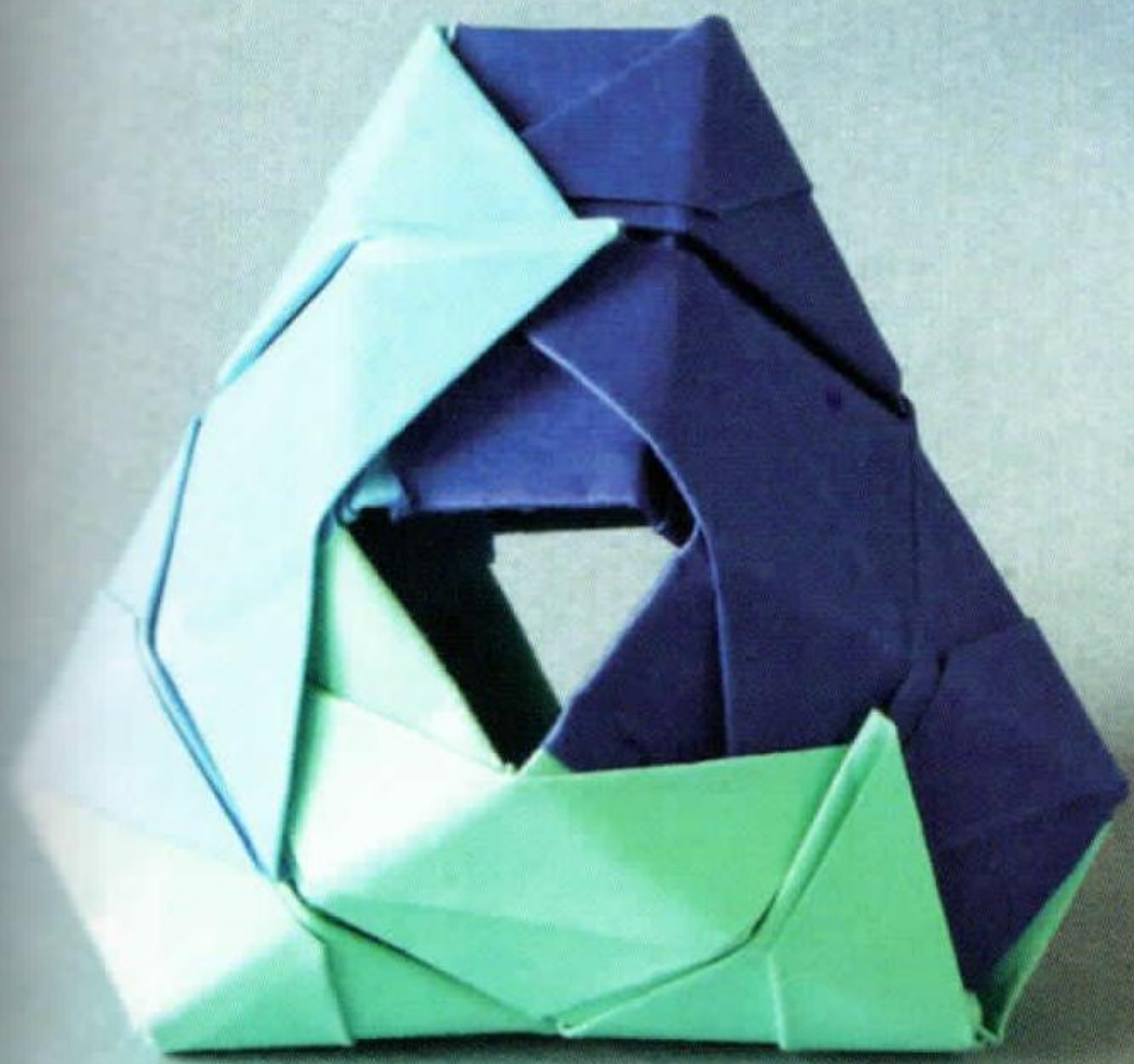
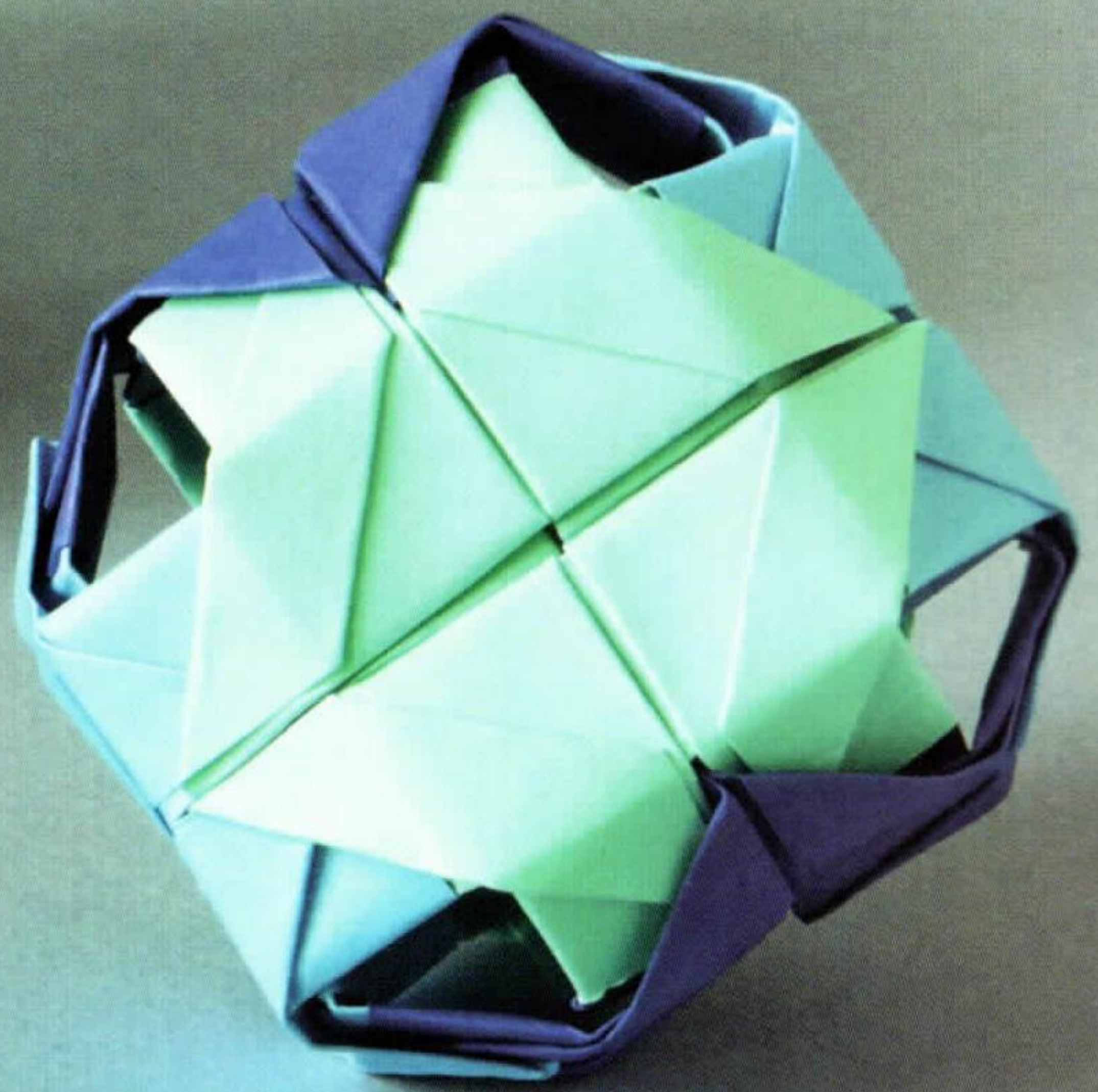
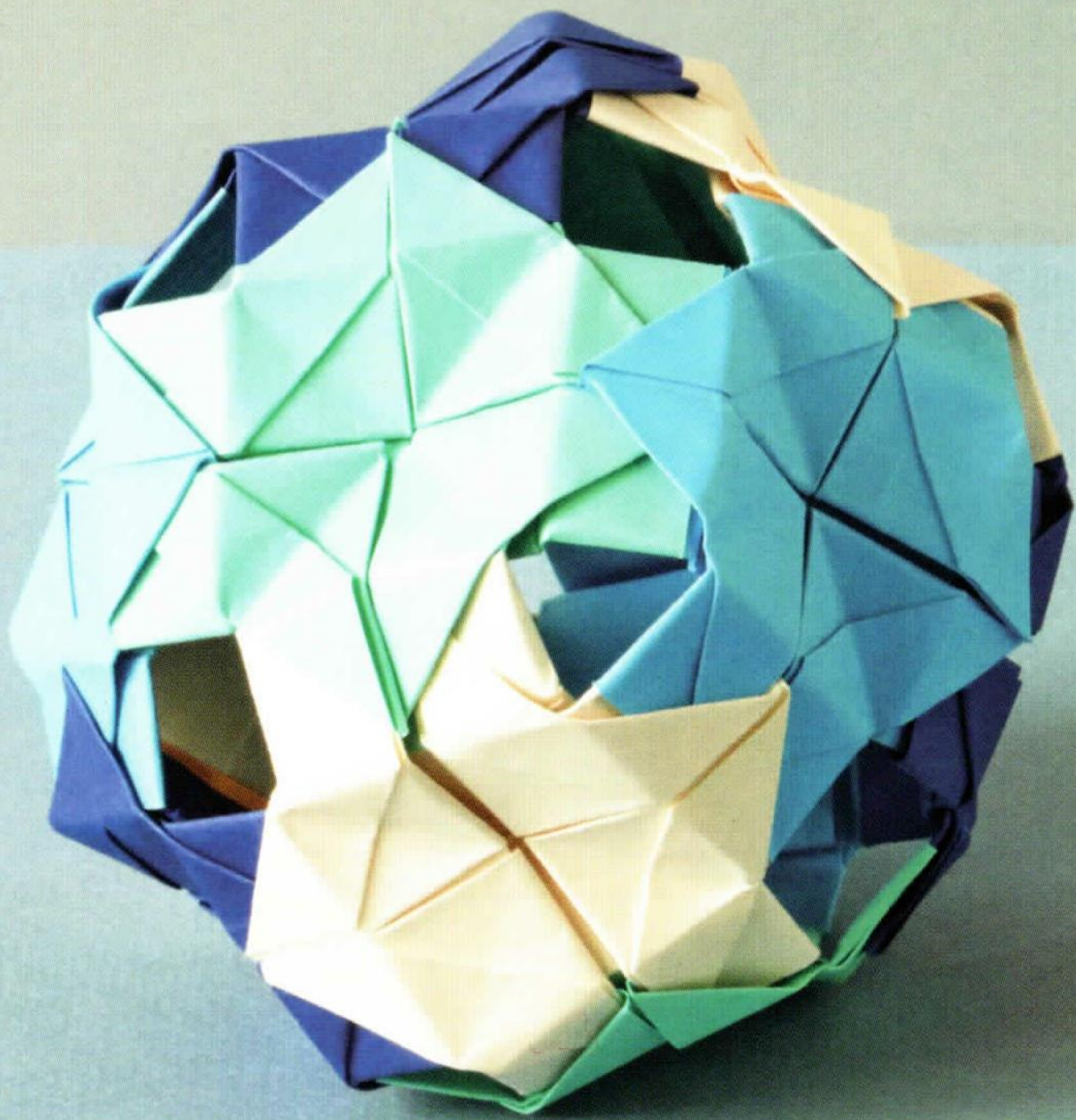

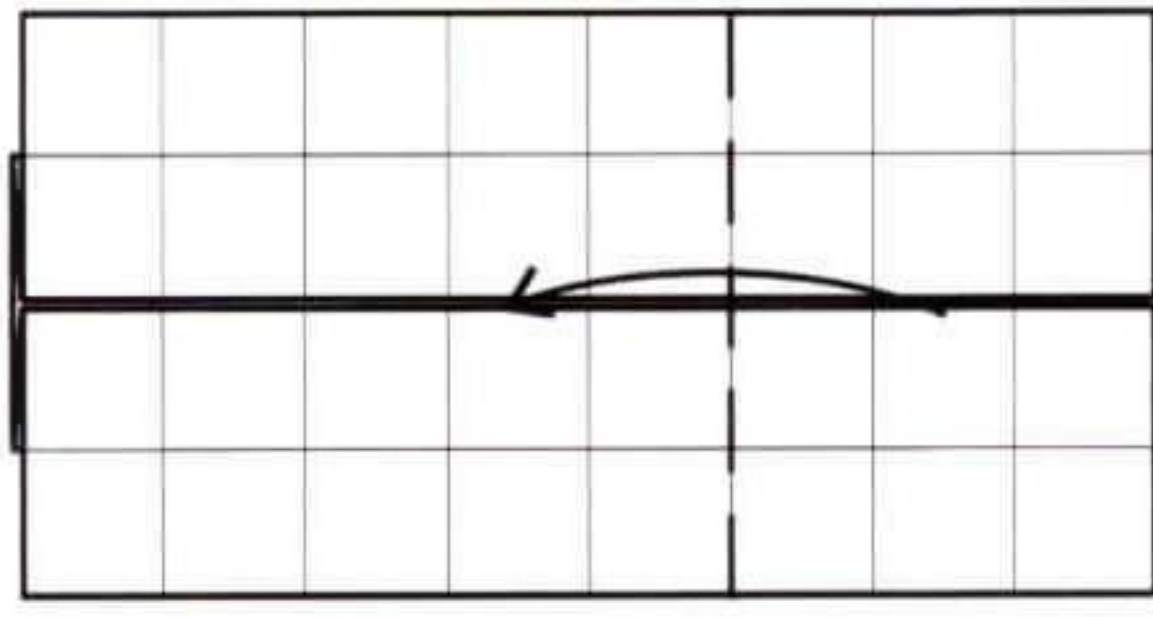

7 Fold one side over.

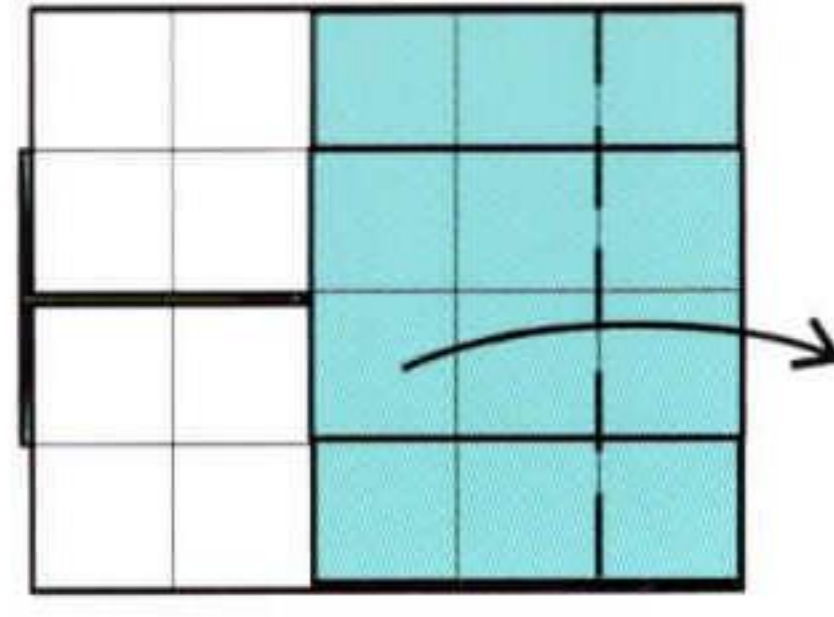

8 Fold the section back again where indicated.

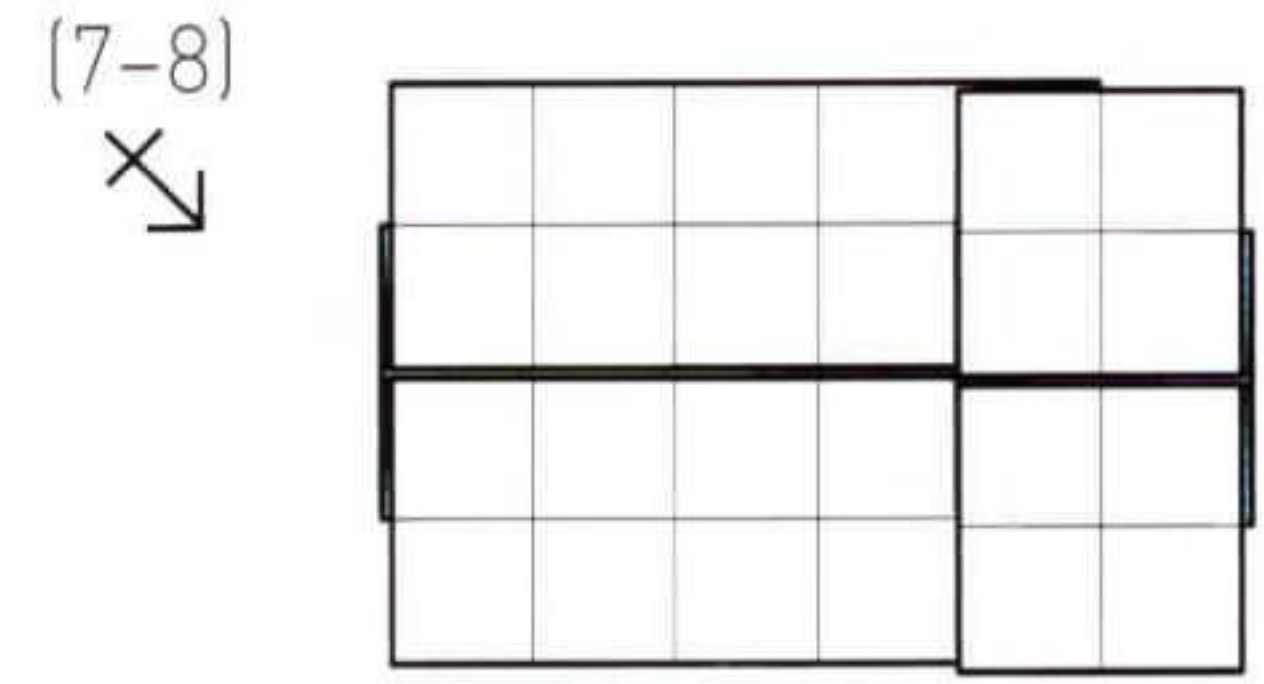

9 Repeat steps 7 to 8 on the other side.

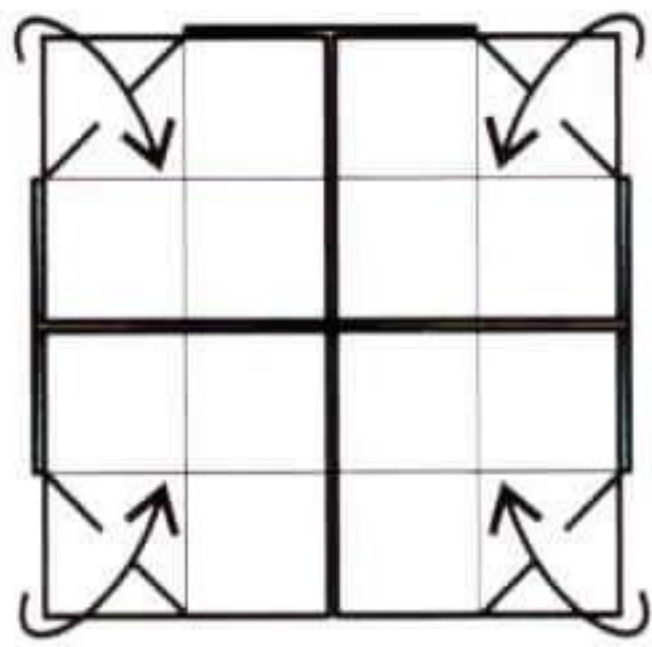

10 Fold the outer corners in.

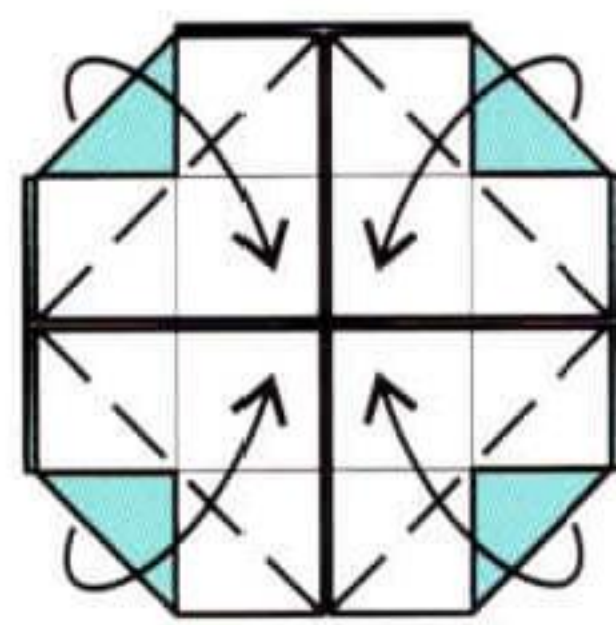

11 Fold the edges over again.

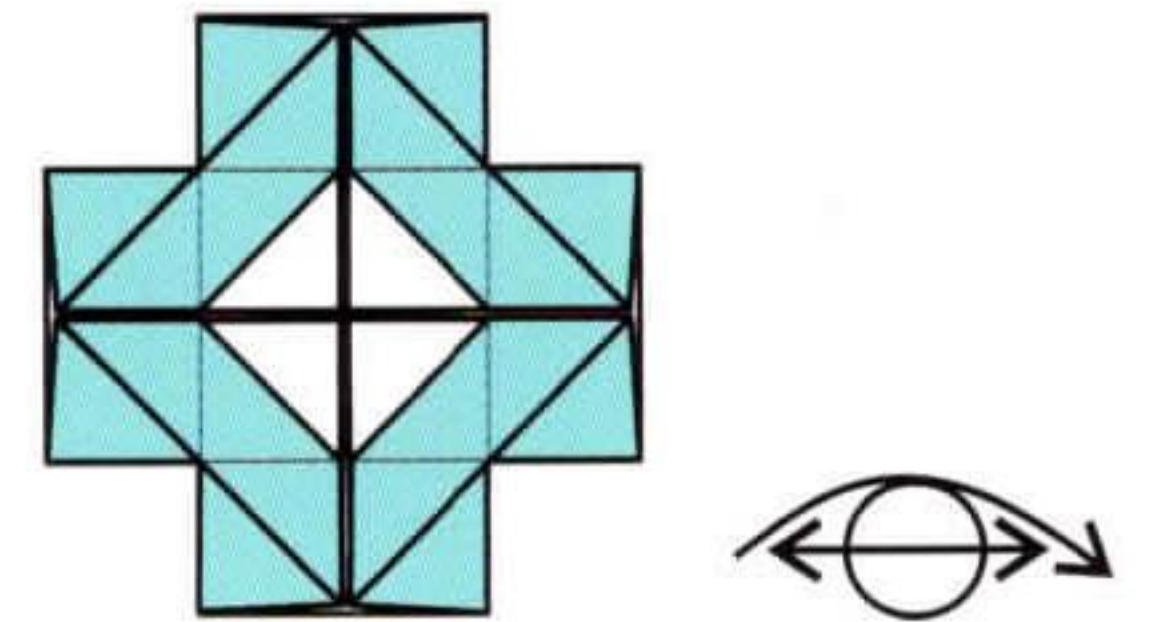

12 Turn the unit over left to right.

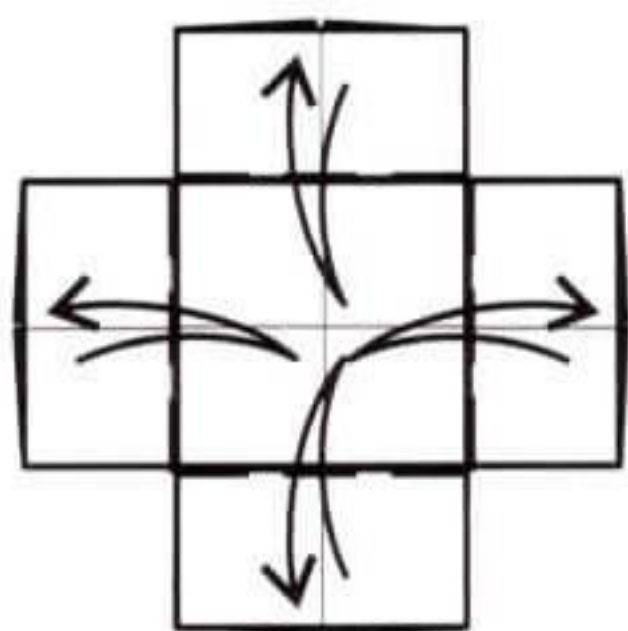

13 Fold the outer edges in and out again to make creases that will be used in the assembly process.

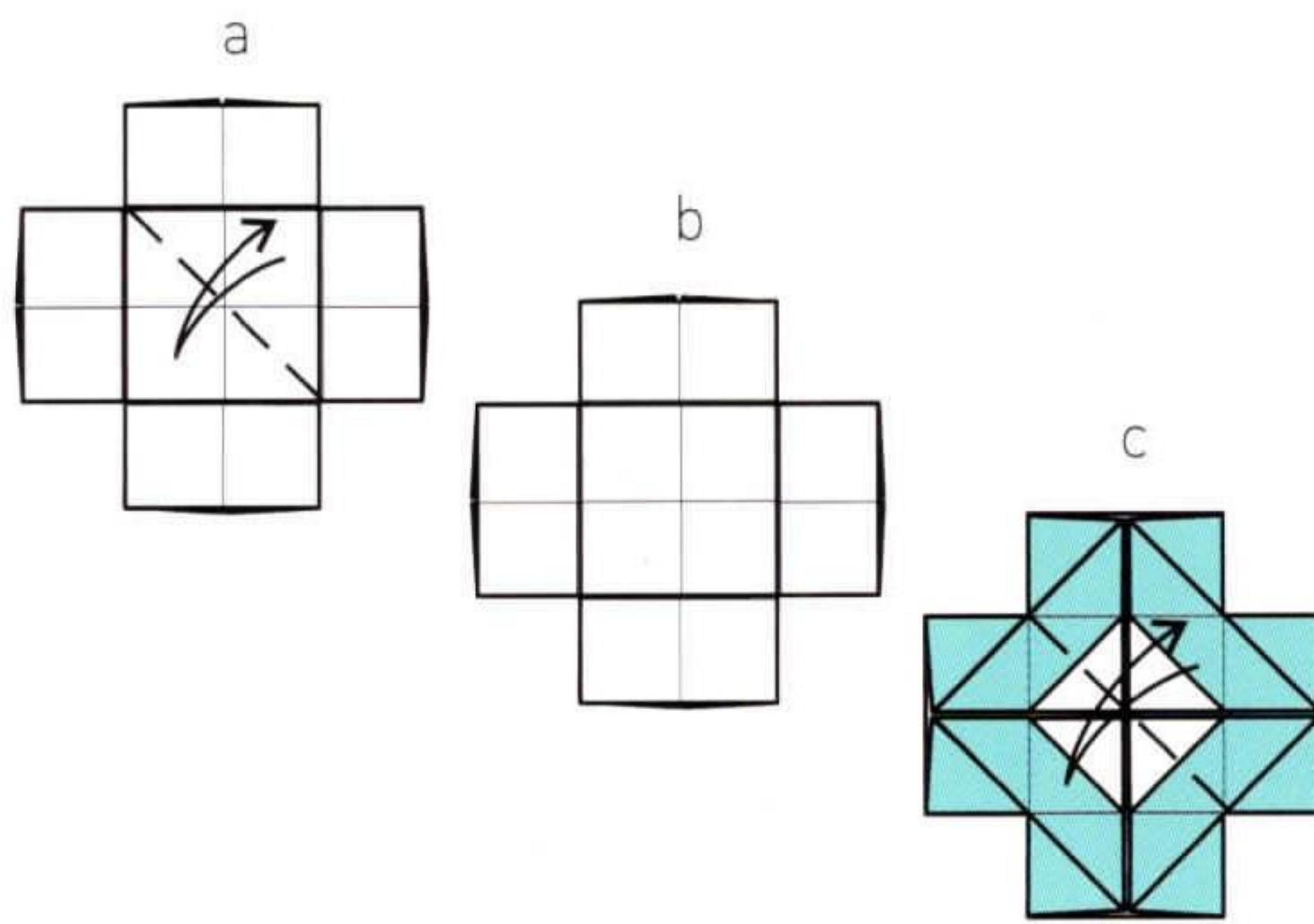

14 Each model will require a different crease.
 (a) Diagonally on the reverse for the hexahedron.
 (b) No crease for the cube.
 (c) Diagonally on the front for more advanced assemblies.

HEXAHEDRON ASSEMBLY

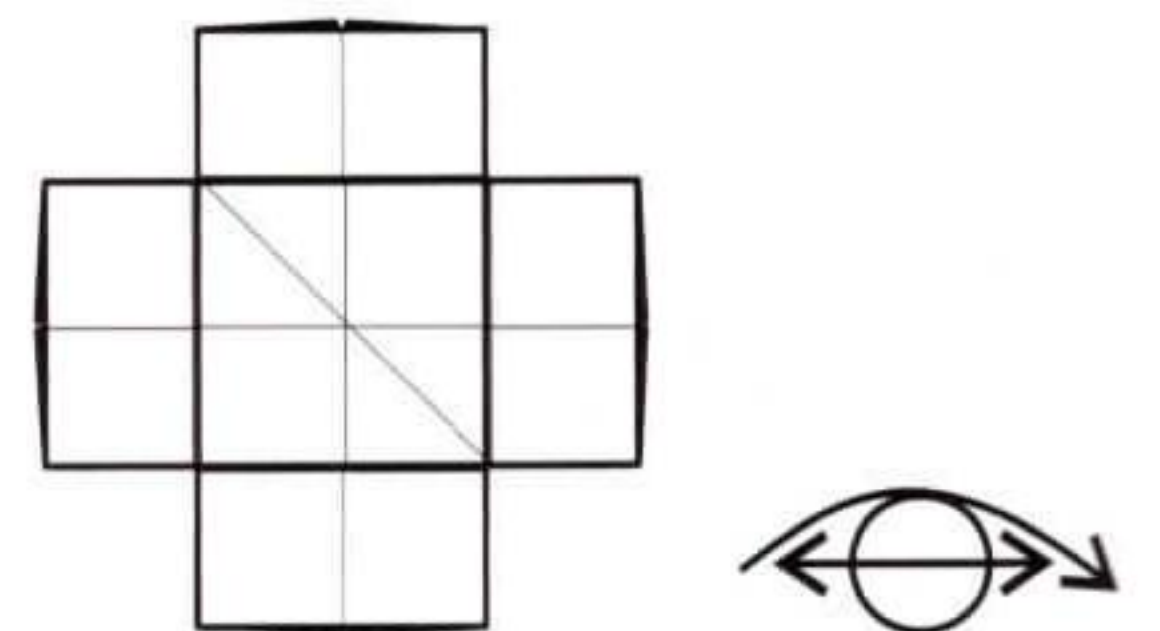

15 Turn the unit over left to right.

JOINING TWO UNITS

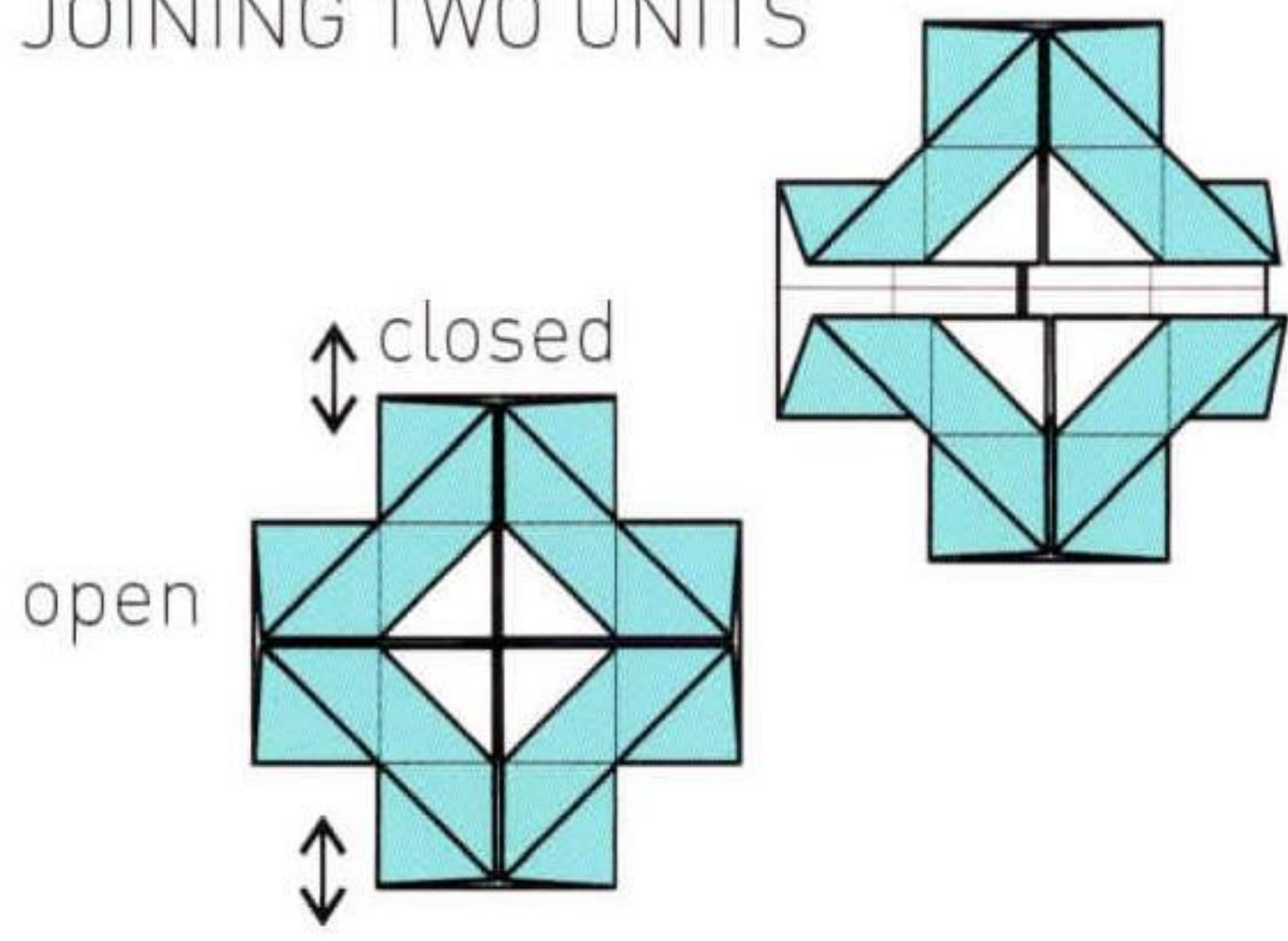

16 The unit has an open and closed axis. The objective of the assembly is to place the open tabs into the closed tabs.

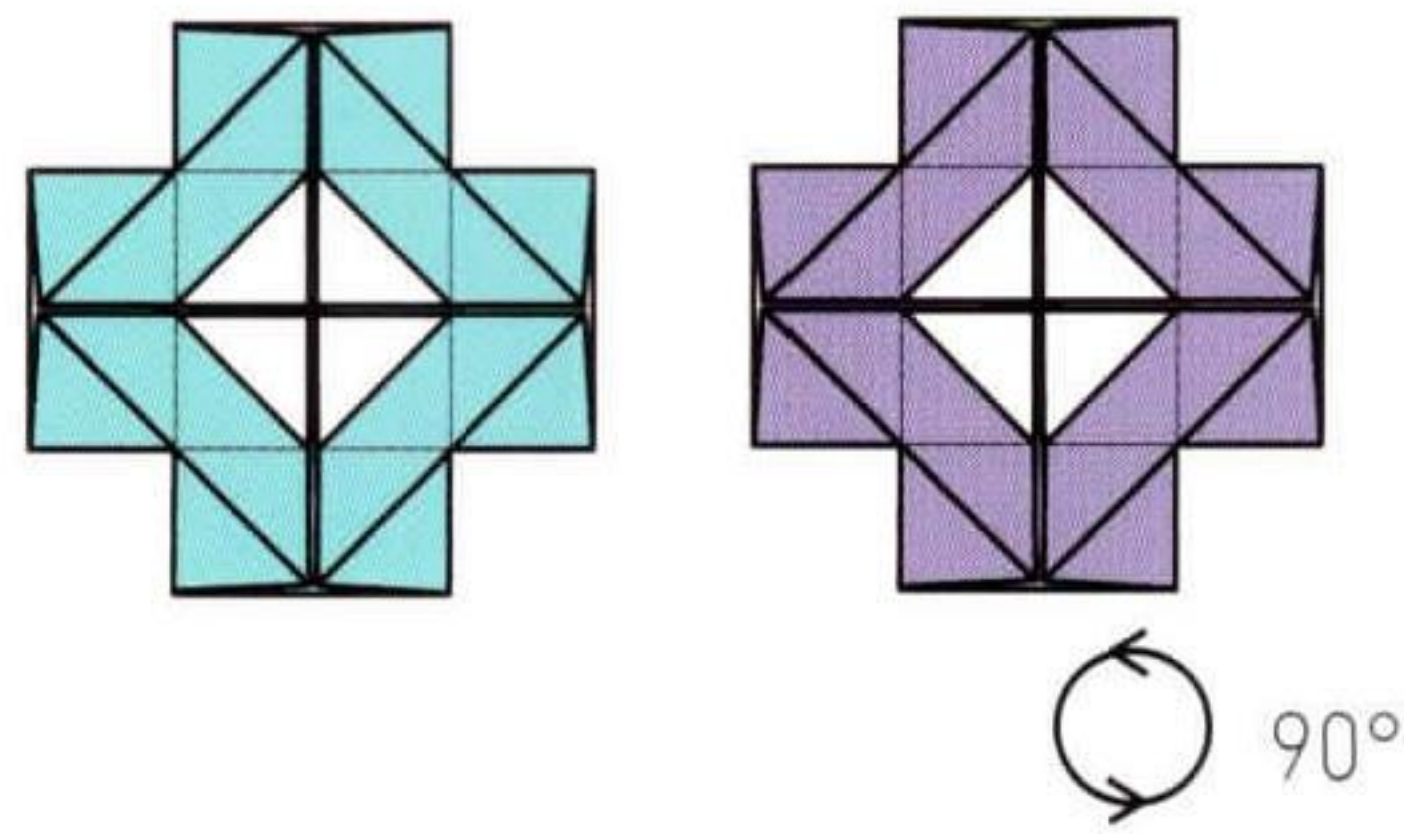

17 Align two units, then rotate one by 90°. This will match the 'closed' axis with the 'open axis'.

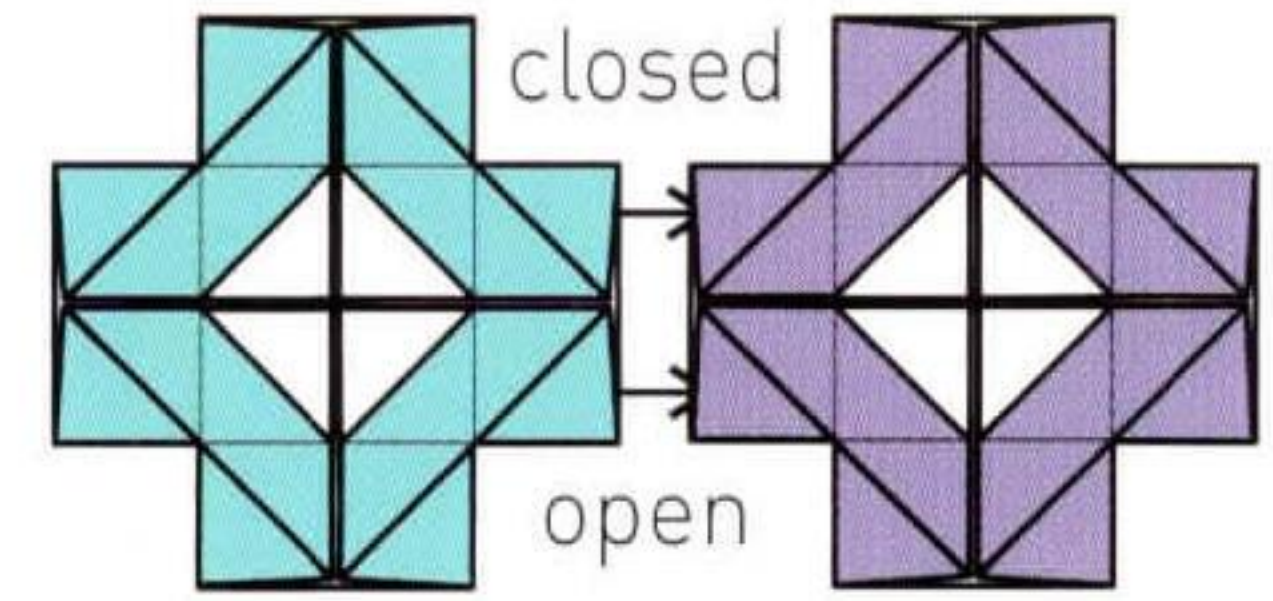

18 Insert the closed tab into the open tab.

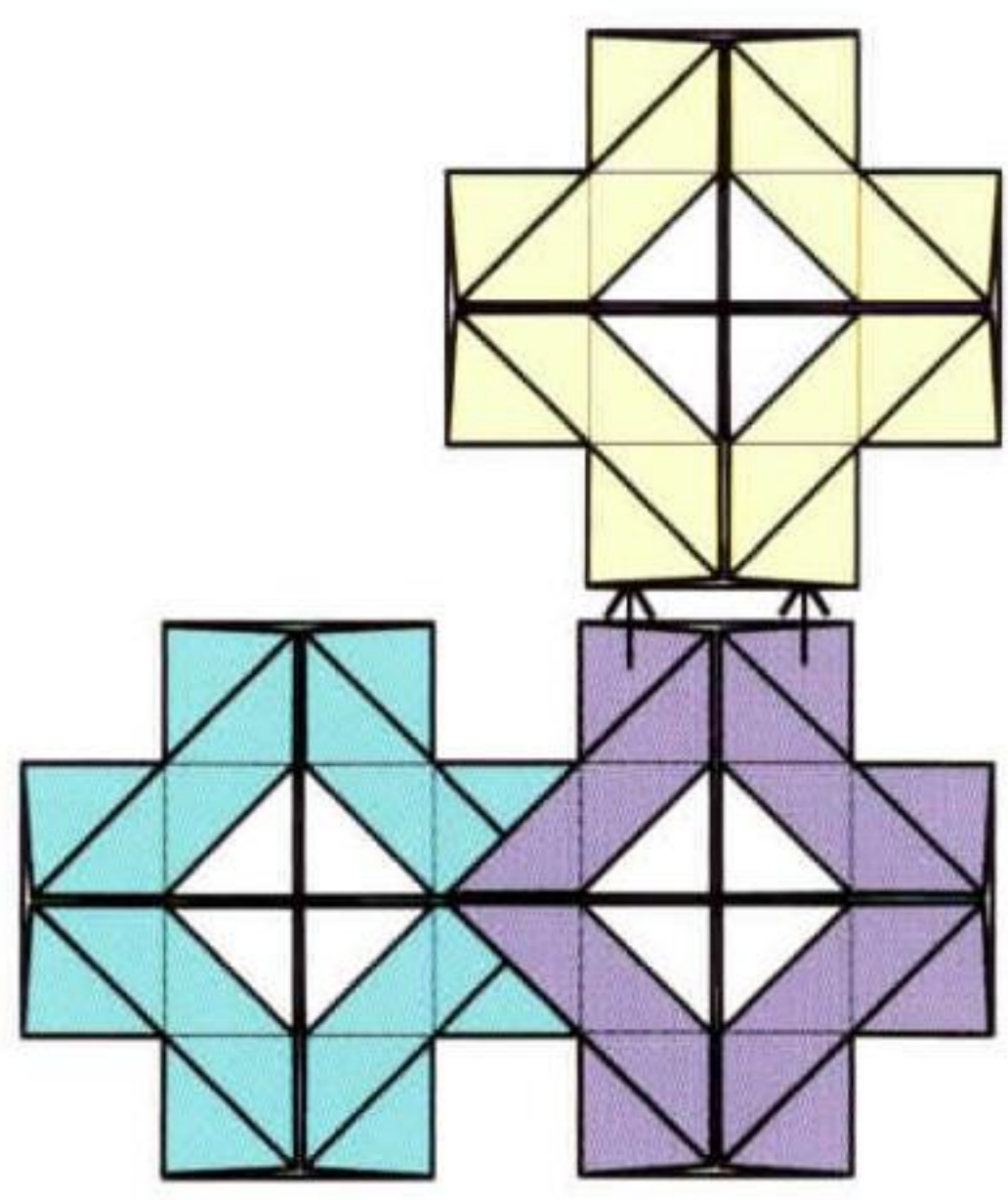

19 Add a third unit, again inserting a closed tab into an open tab.

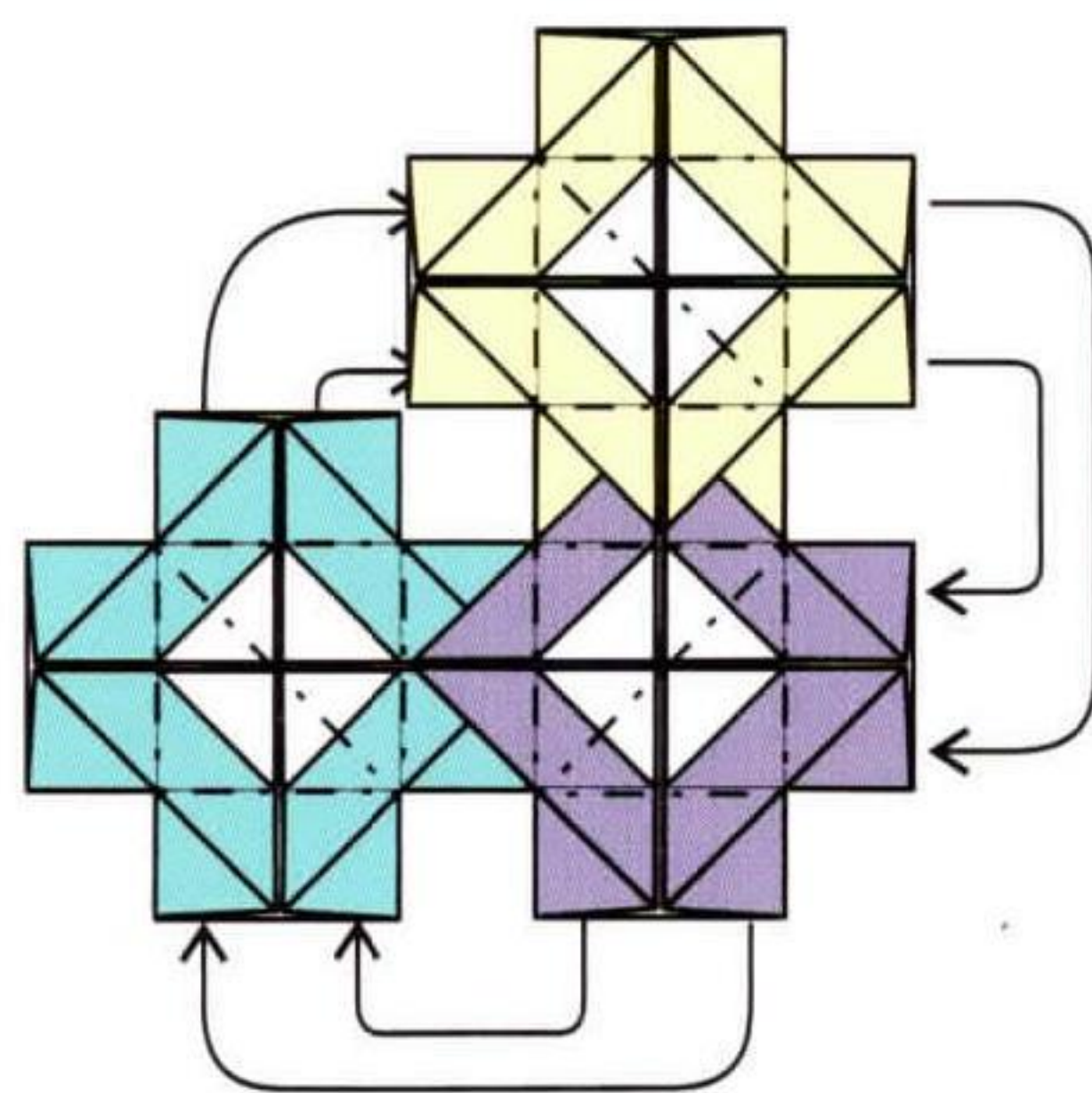

20 Three units can be joined to make a hexahedron.

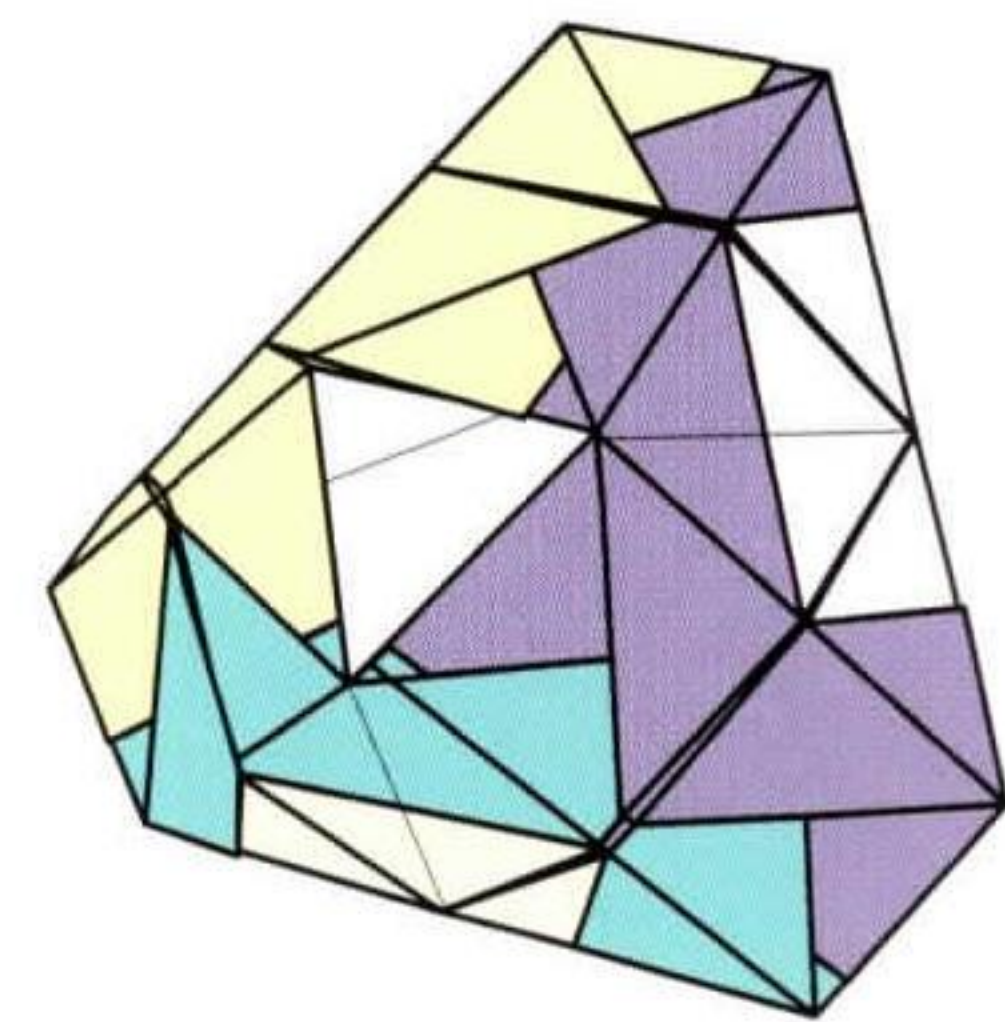

21 Complete.

ASSEMBLING LARGER MODELS

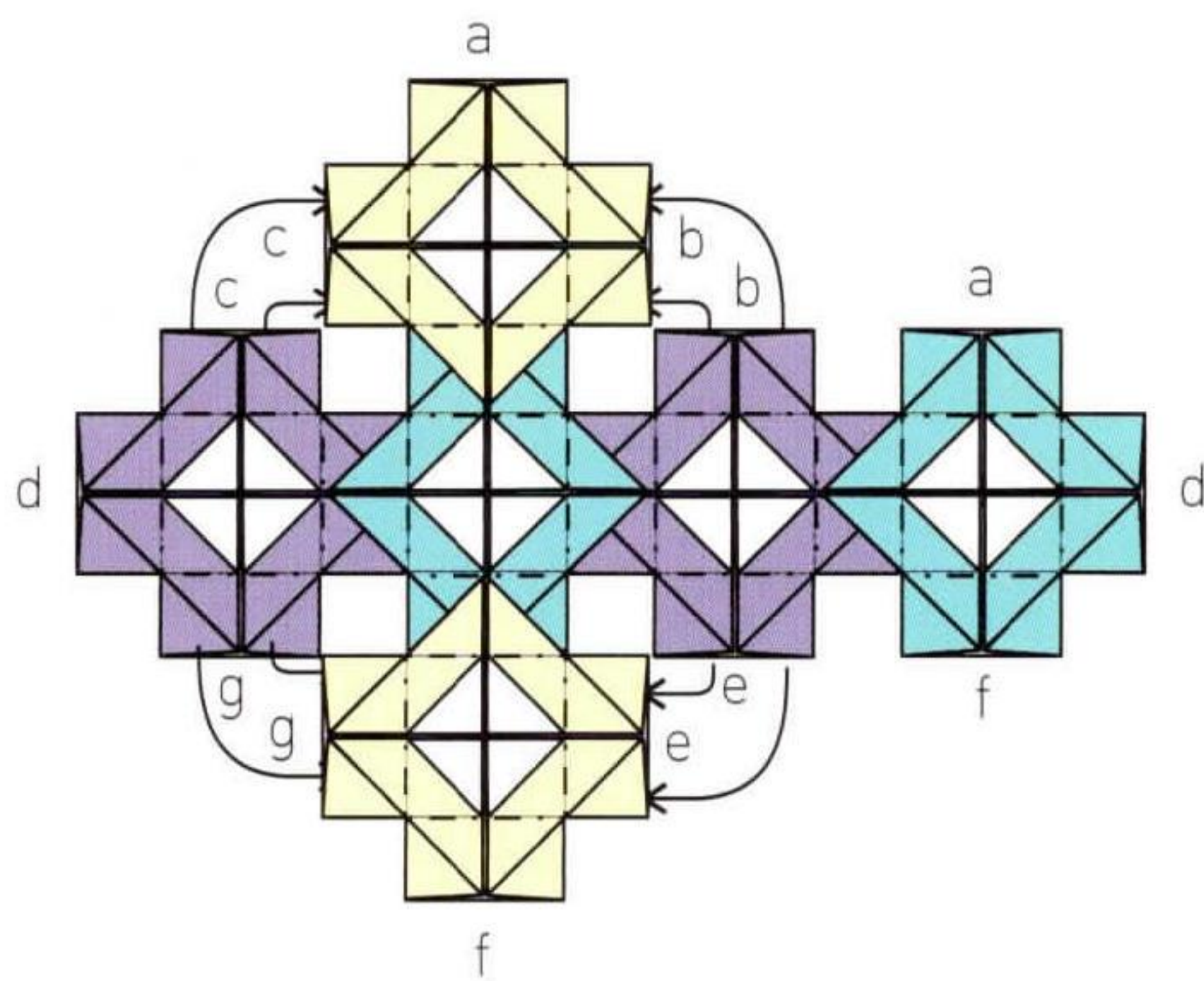

22 Six units can be assembled into a cube. The net above shows the assembly. Insert tab (a) into pocket (a). Then repeat for (b) to (g).

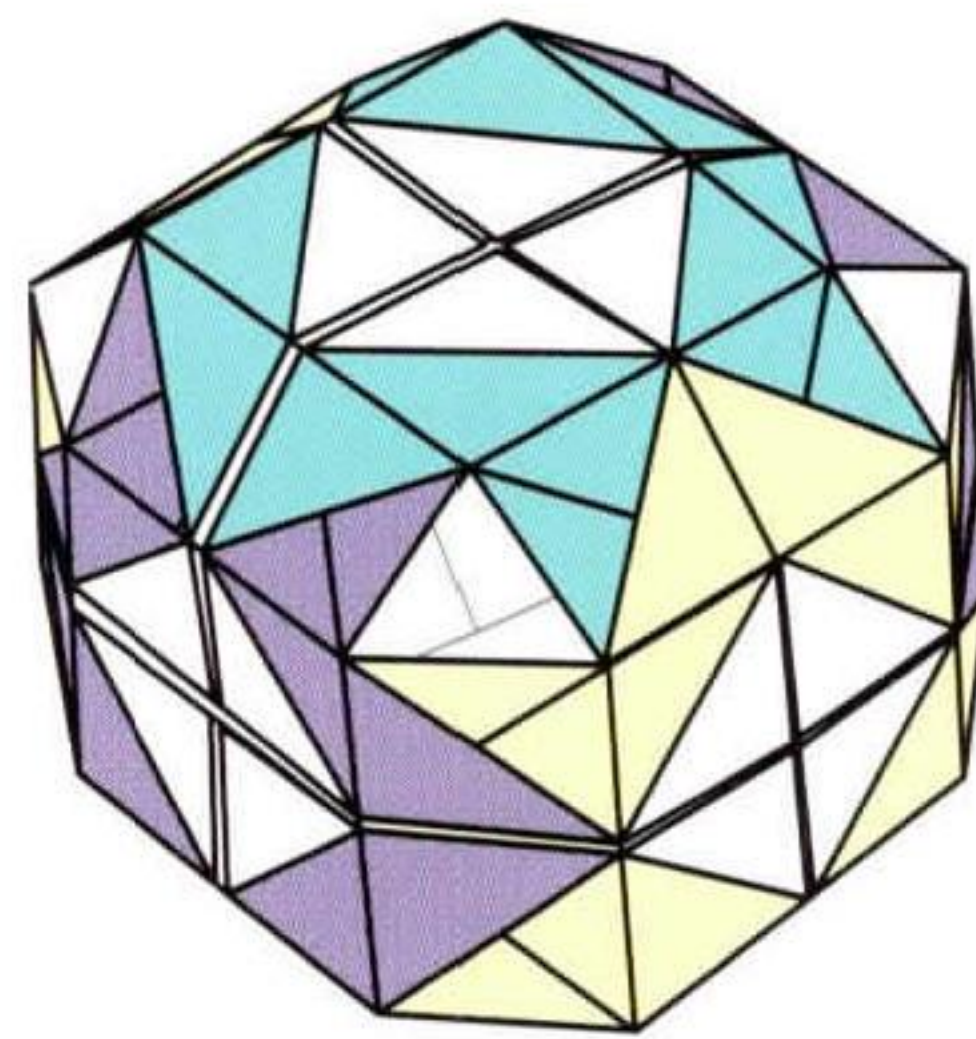

23 Cube complete.

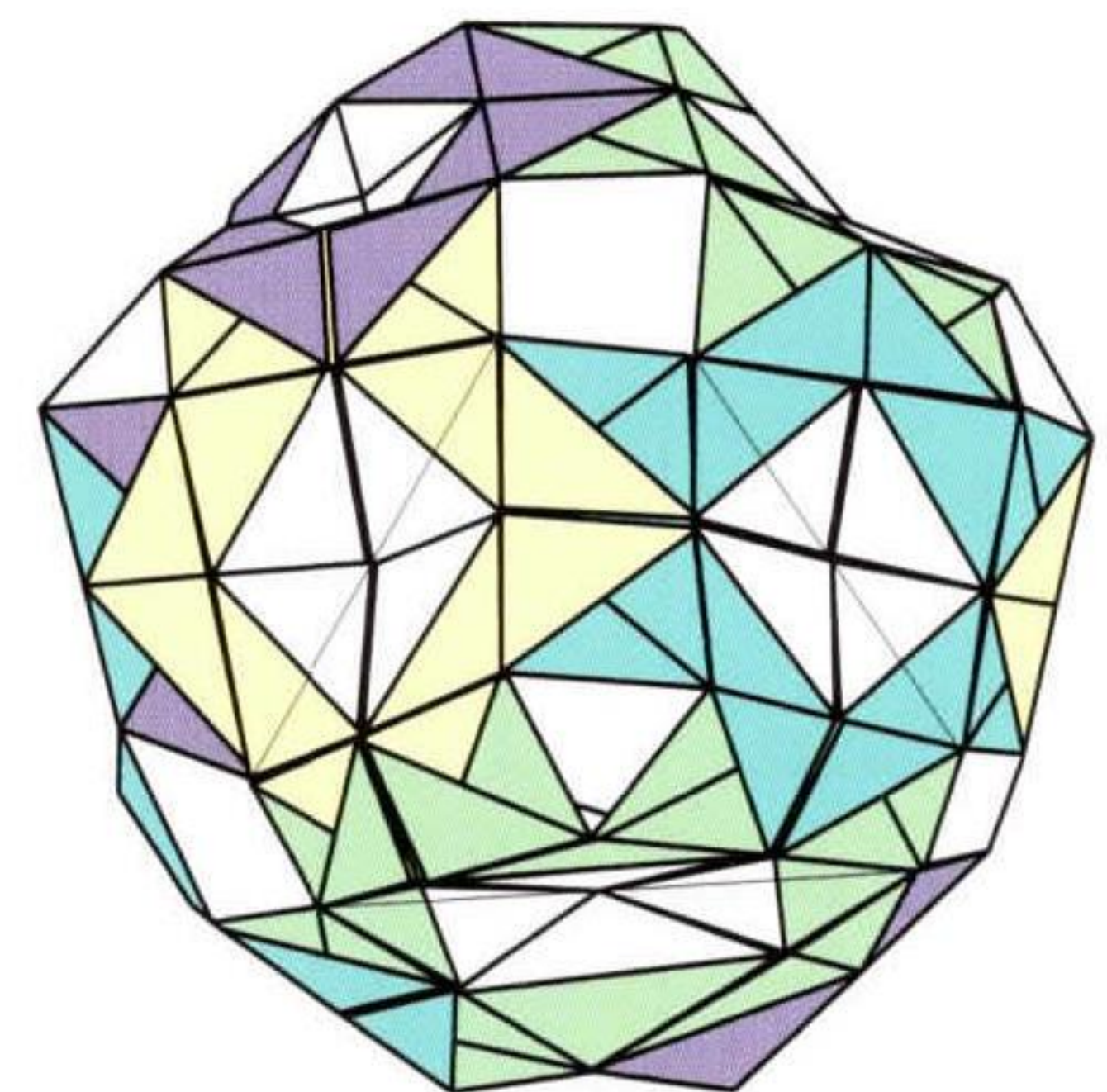

24 The module can be used to make other regular solids by combining 12 units.

ADVANCED MODULARS

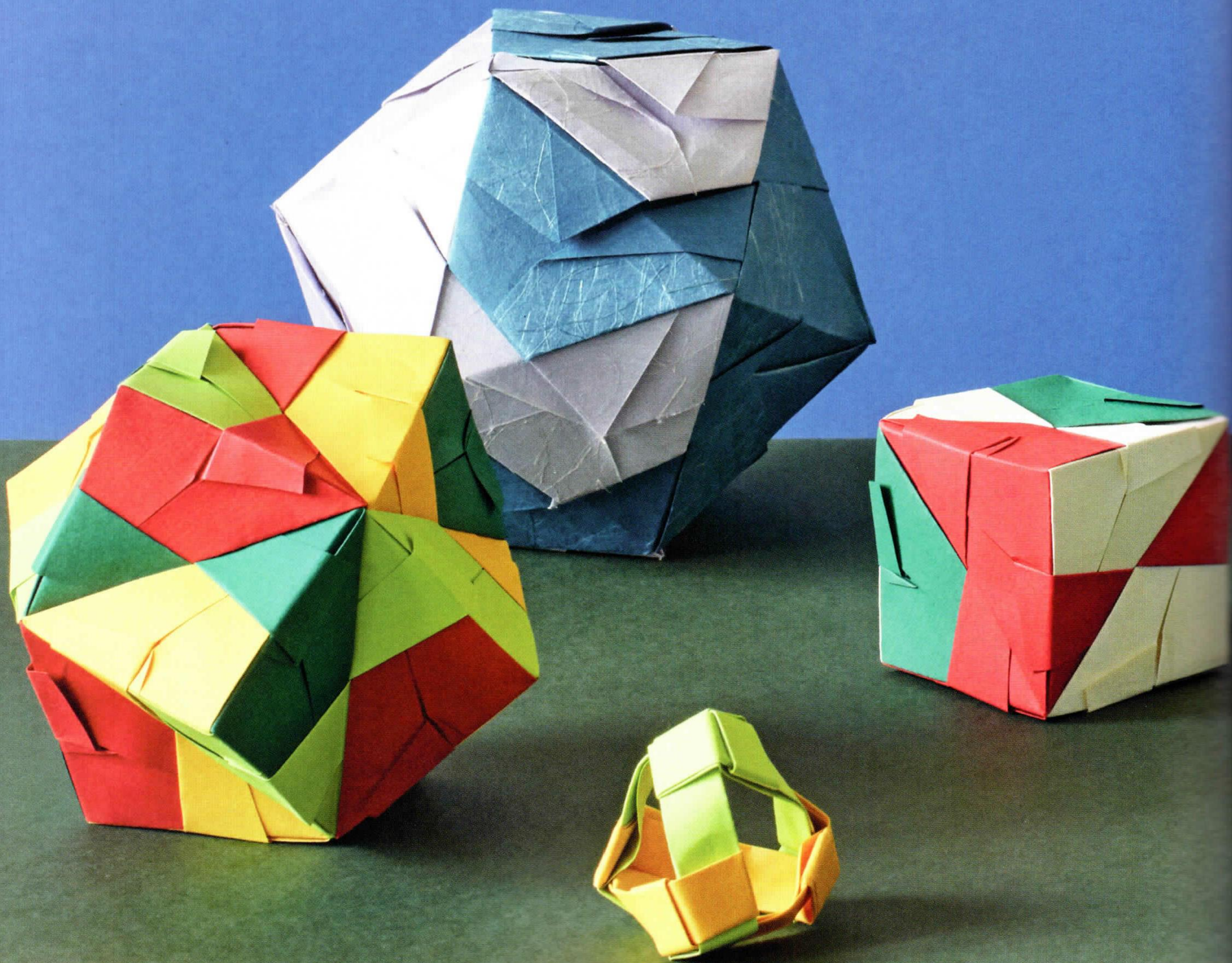

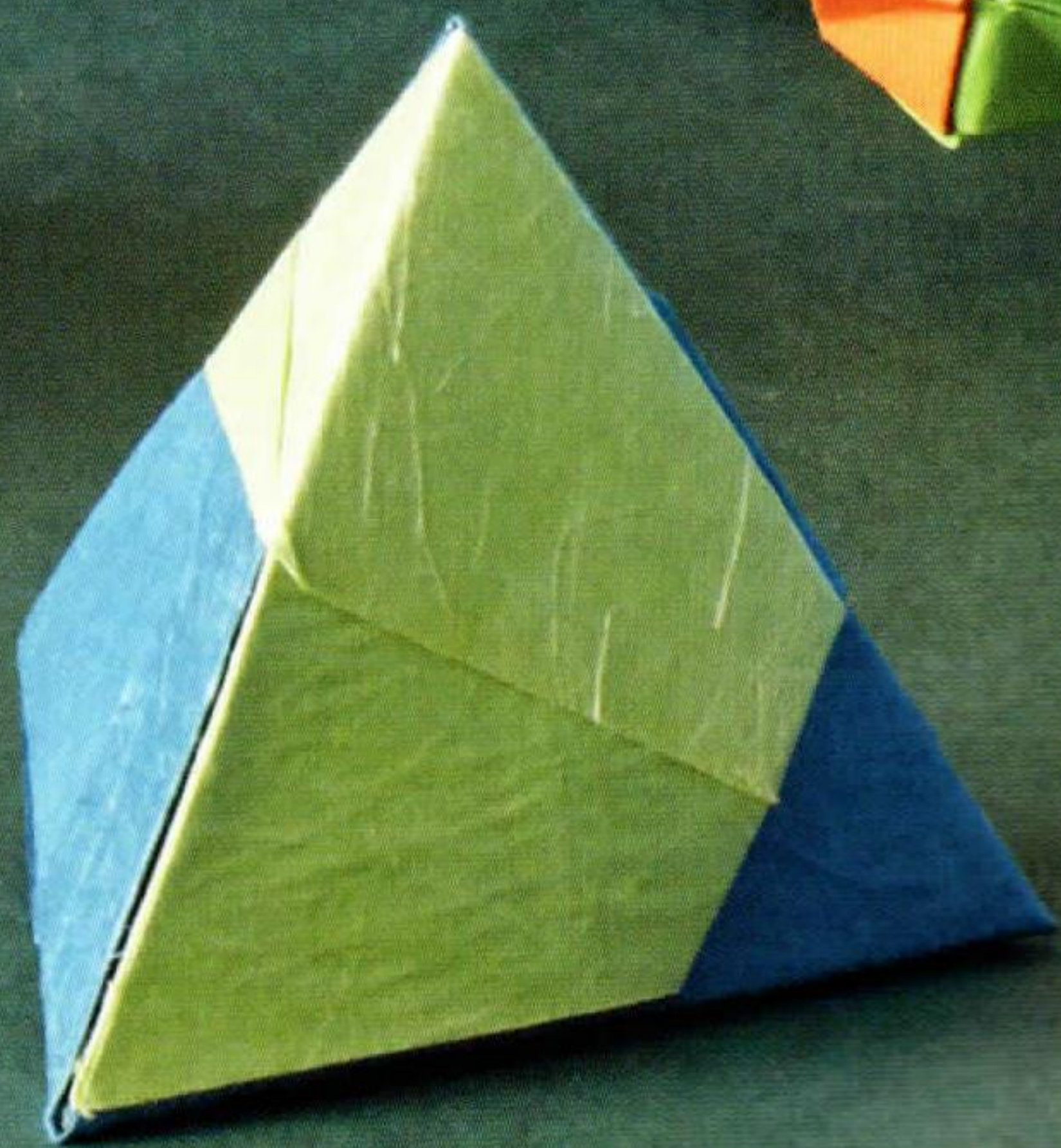
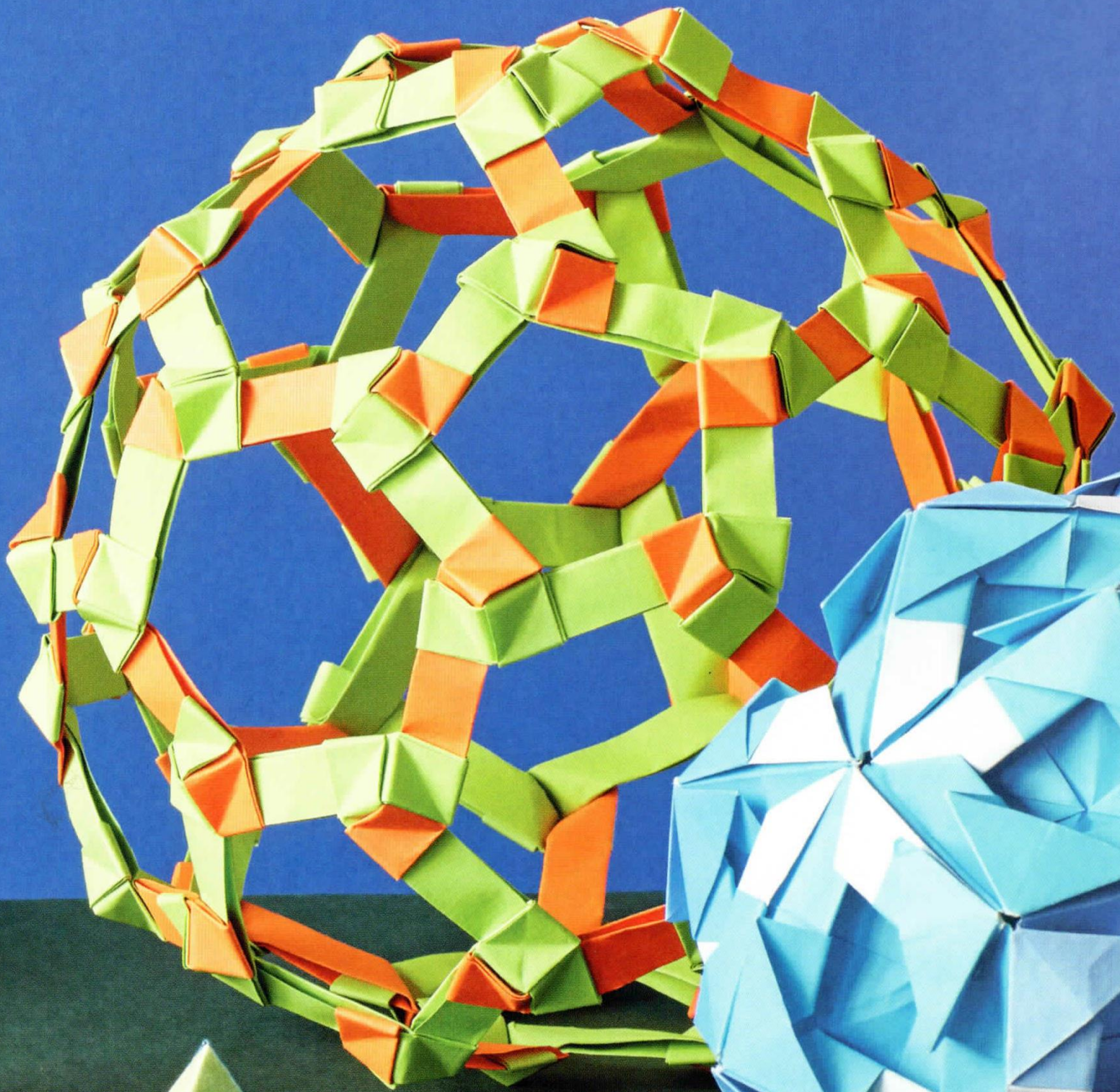

Equilateral Module

**

This modular project enables the construction of polygons made from equilateral triangles. There are various methods of weaving units together. Unlike most unit-based origami projects, some of these assemblies include both similar and mirrored units.

18 X 18CM (7 X 7IN) ICOSAHEDRON

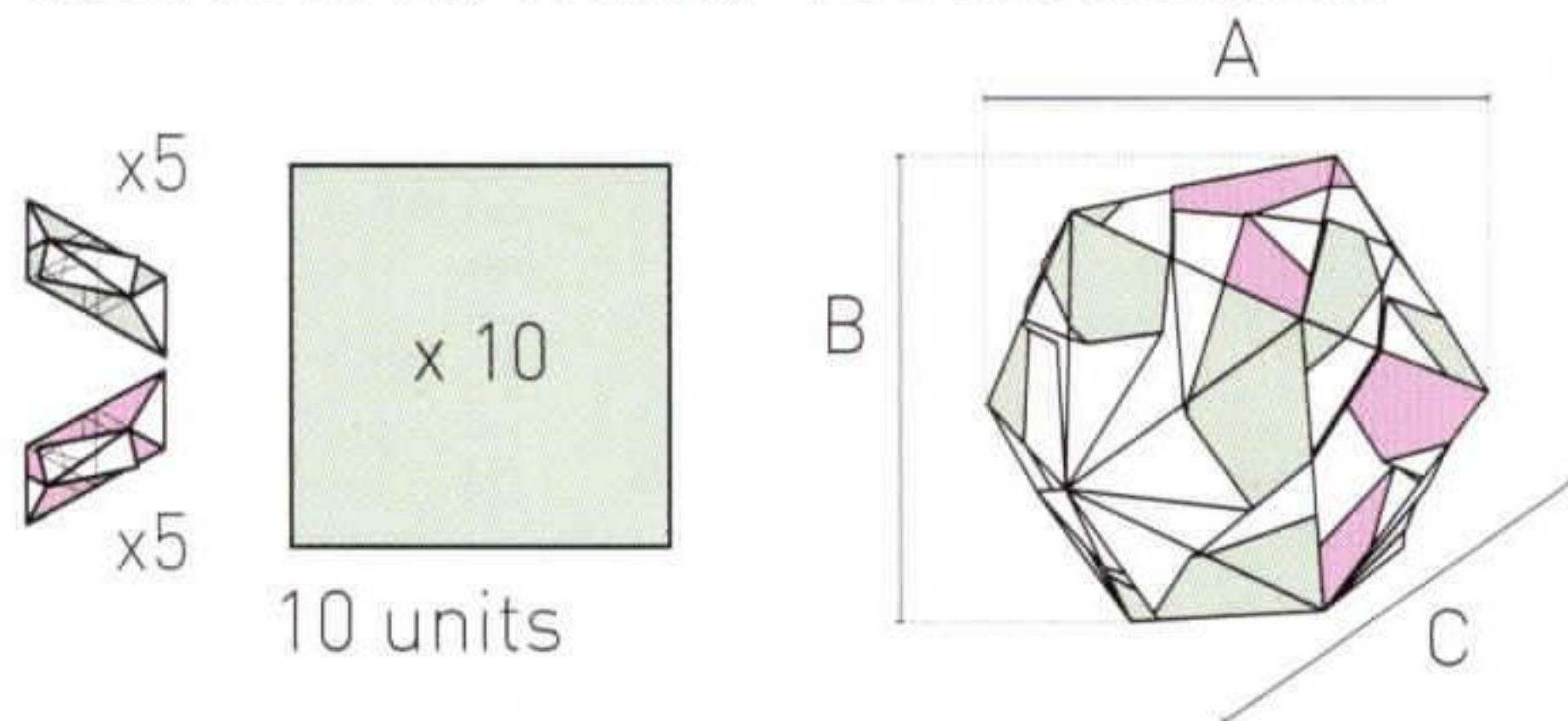

A 16.2cm (6in)
B 16.2cm (6in)
C 16.2cm (6in)

OTHER ASSEMBLIES

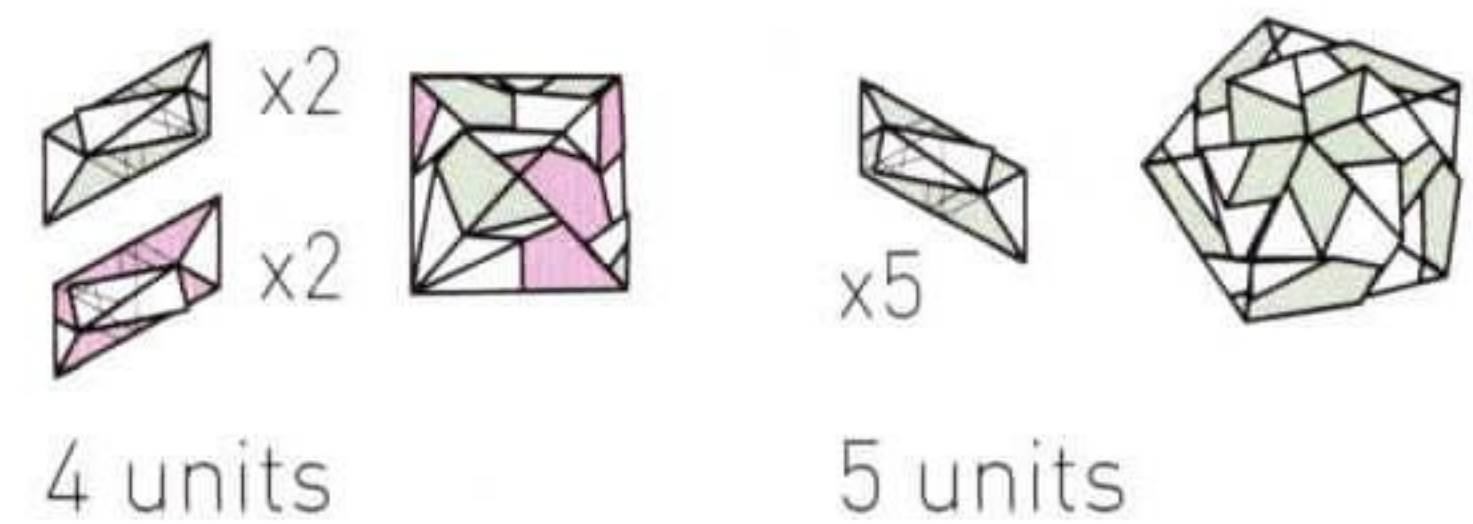

THE ICOSAHEDRON IS MADE FROM 10 UNITS. FIVE ARE THE MIRROR IMAGE OF THE OTHER FIVE. START WITH A SQUARE, COLOURED SIDE UP.

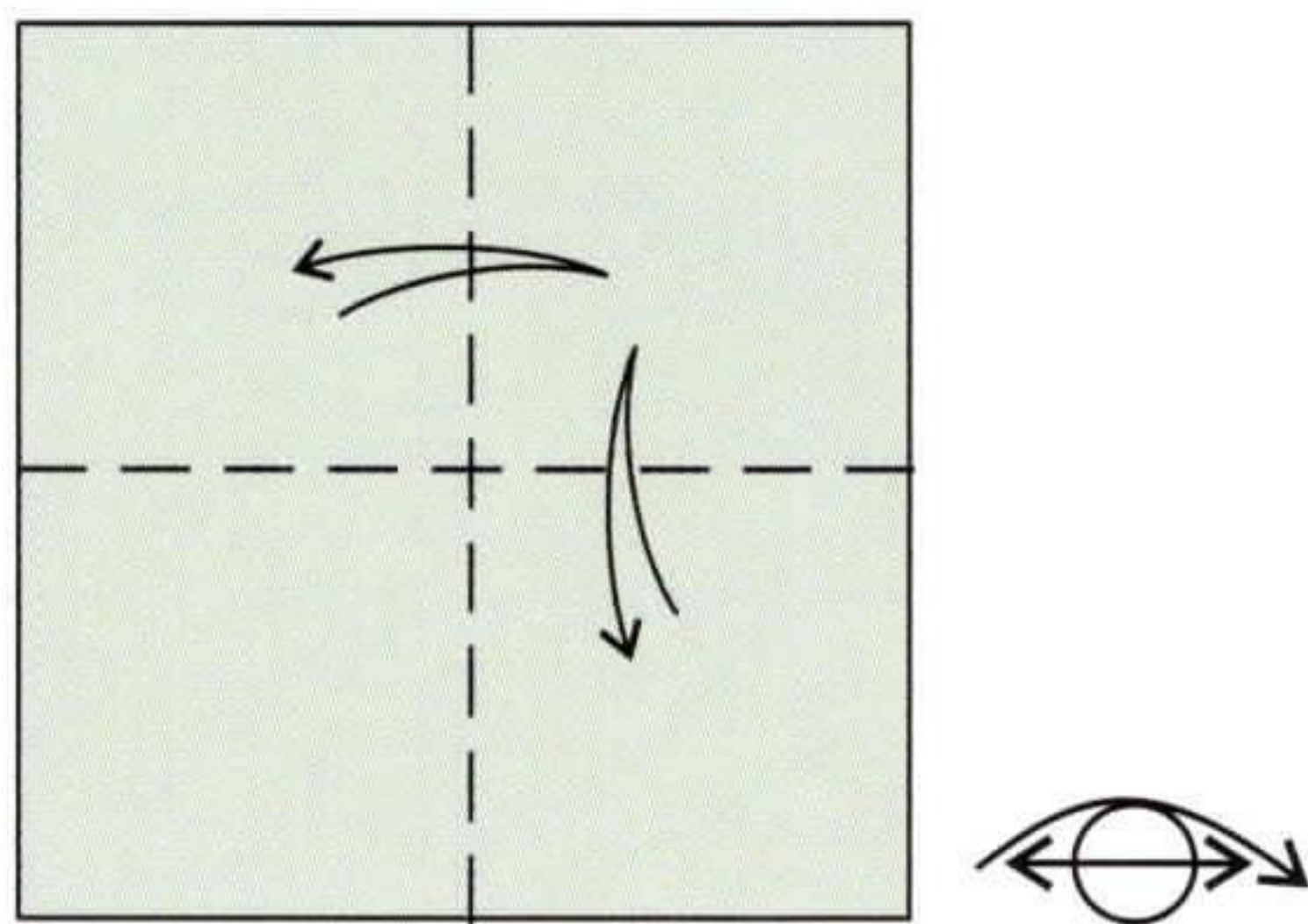

1 Fold and unfold the square in half lengthwise. Then turn the module over left to right.

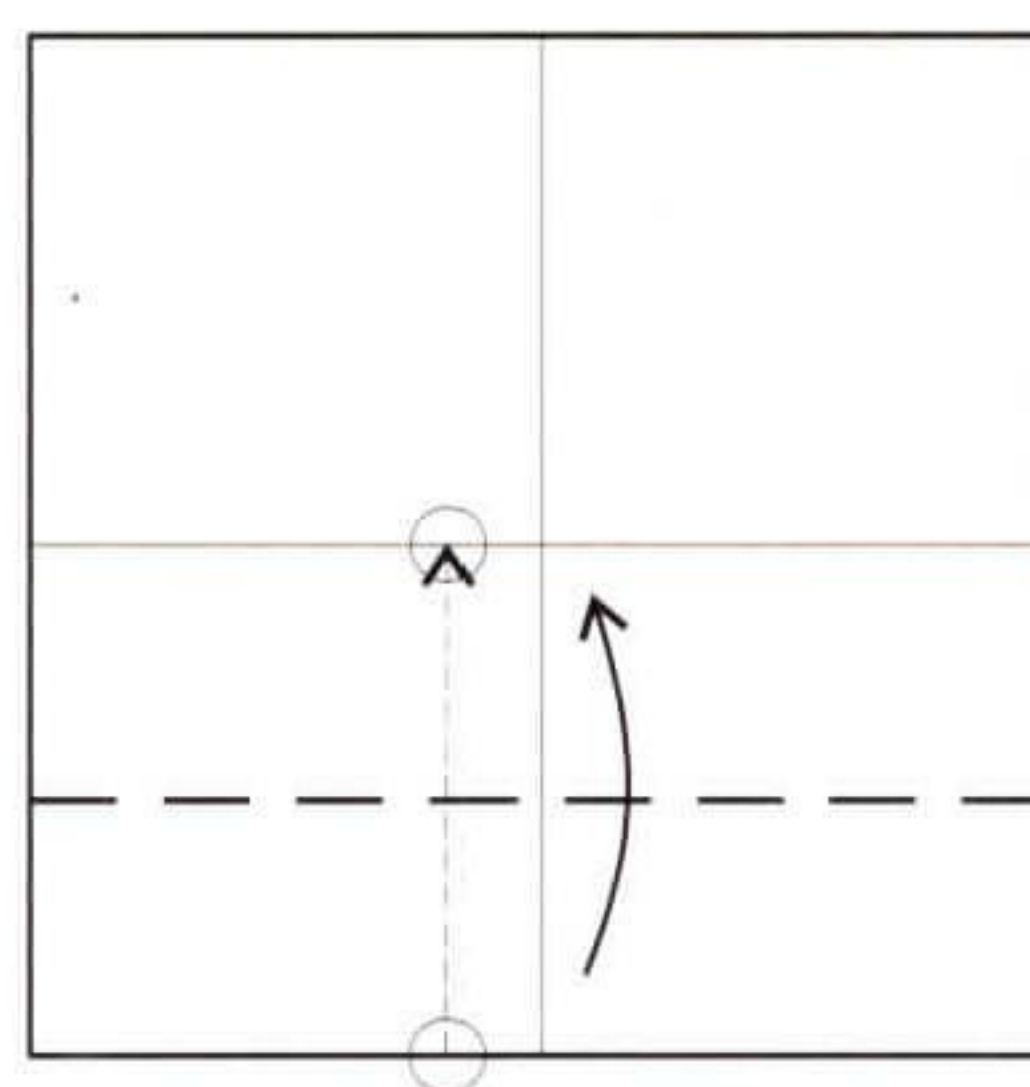

2 Fold the lower edge up to touch the middle crease.

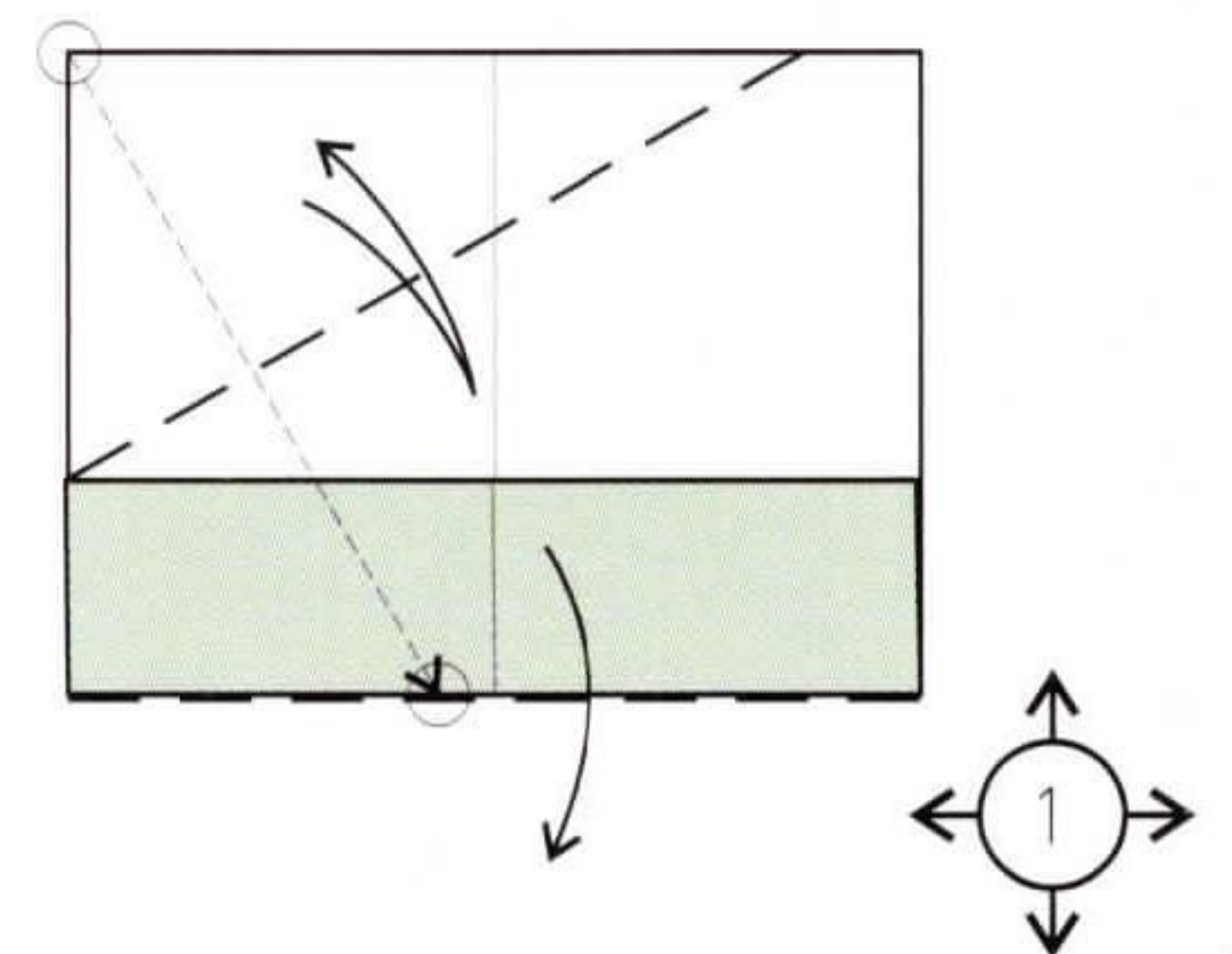

3 Fold the upper left corner down to touch the lower folded edge. Then unfold back to a square.

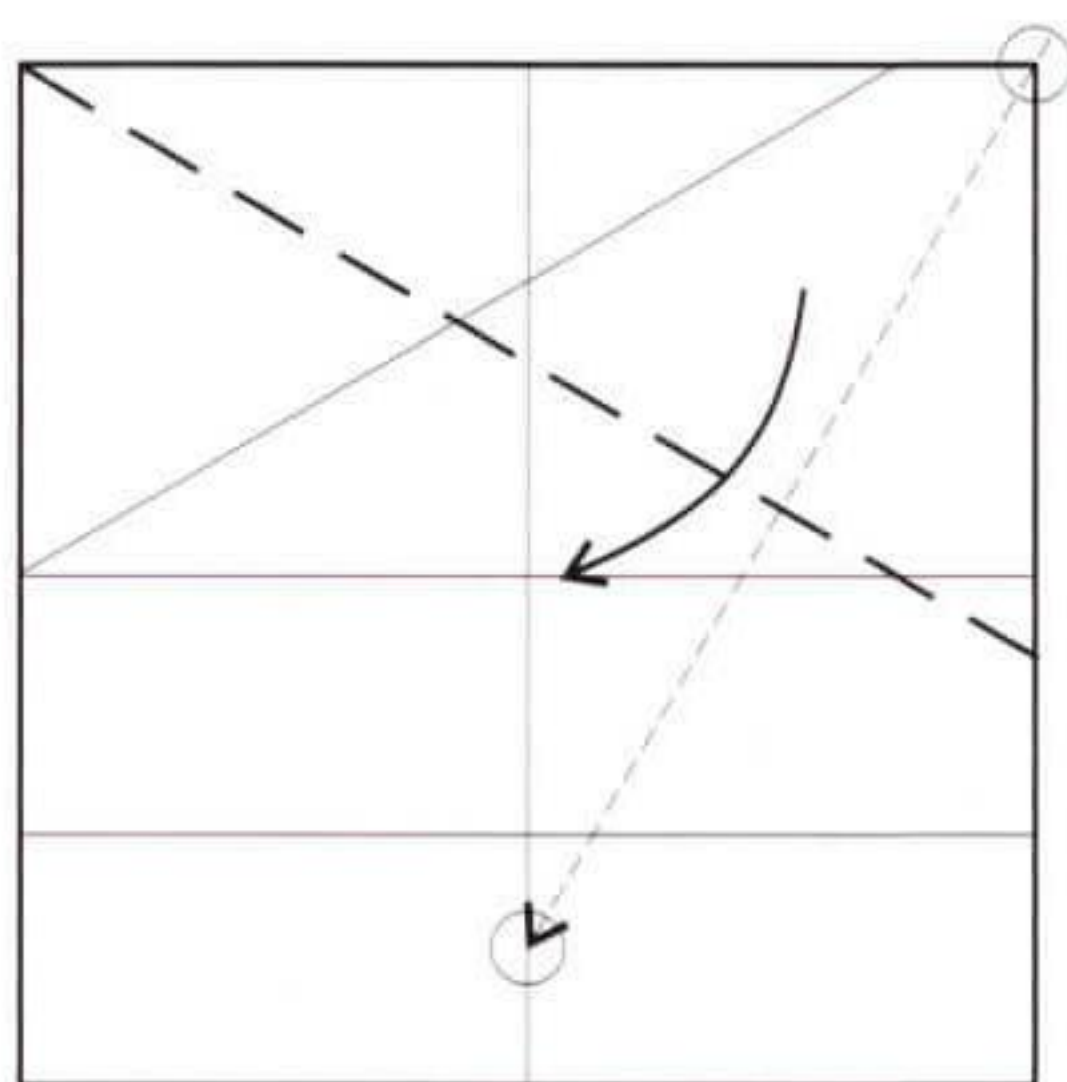

4 Fold upper right corner in to touch the middle crease.

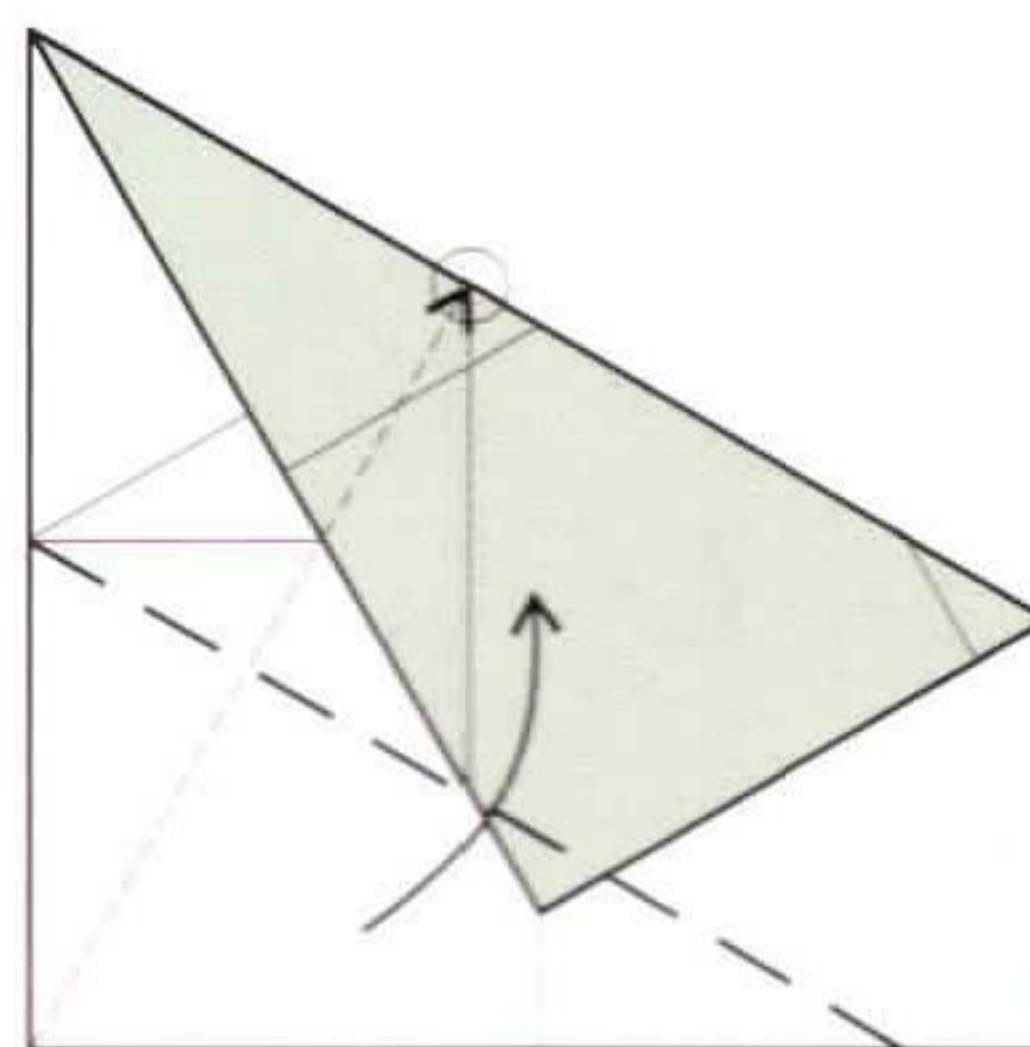

5 Fold the lower left corner up to touch the crease in the folded edge above.

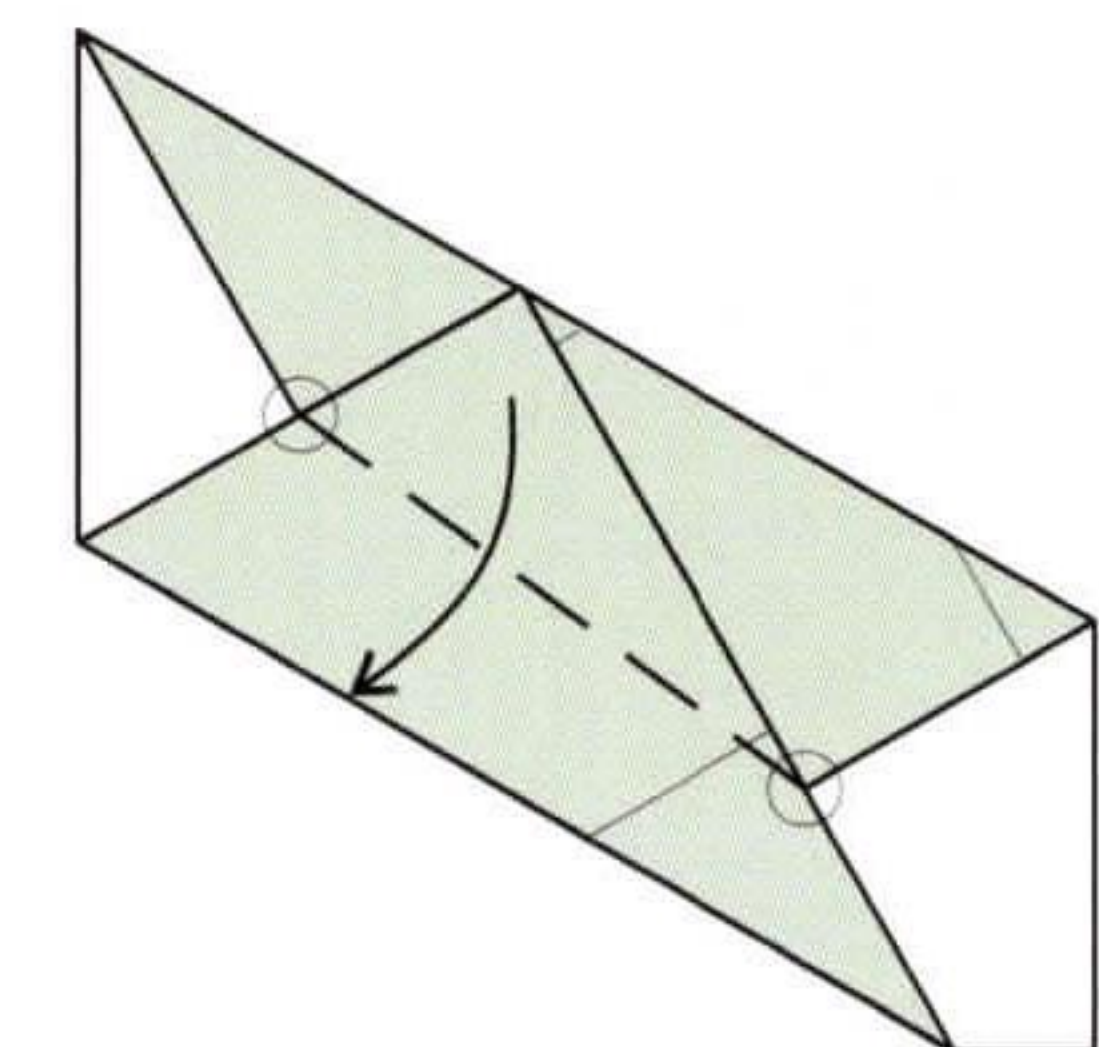

6 Fold the corner over at the point where the upper and lower folded sections touch.

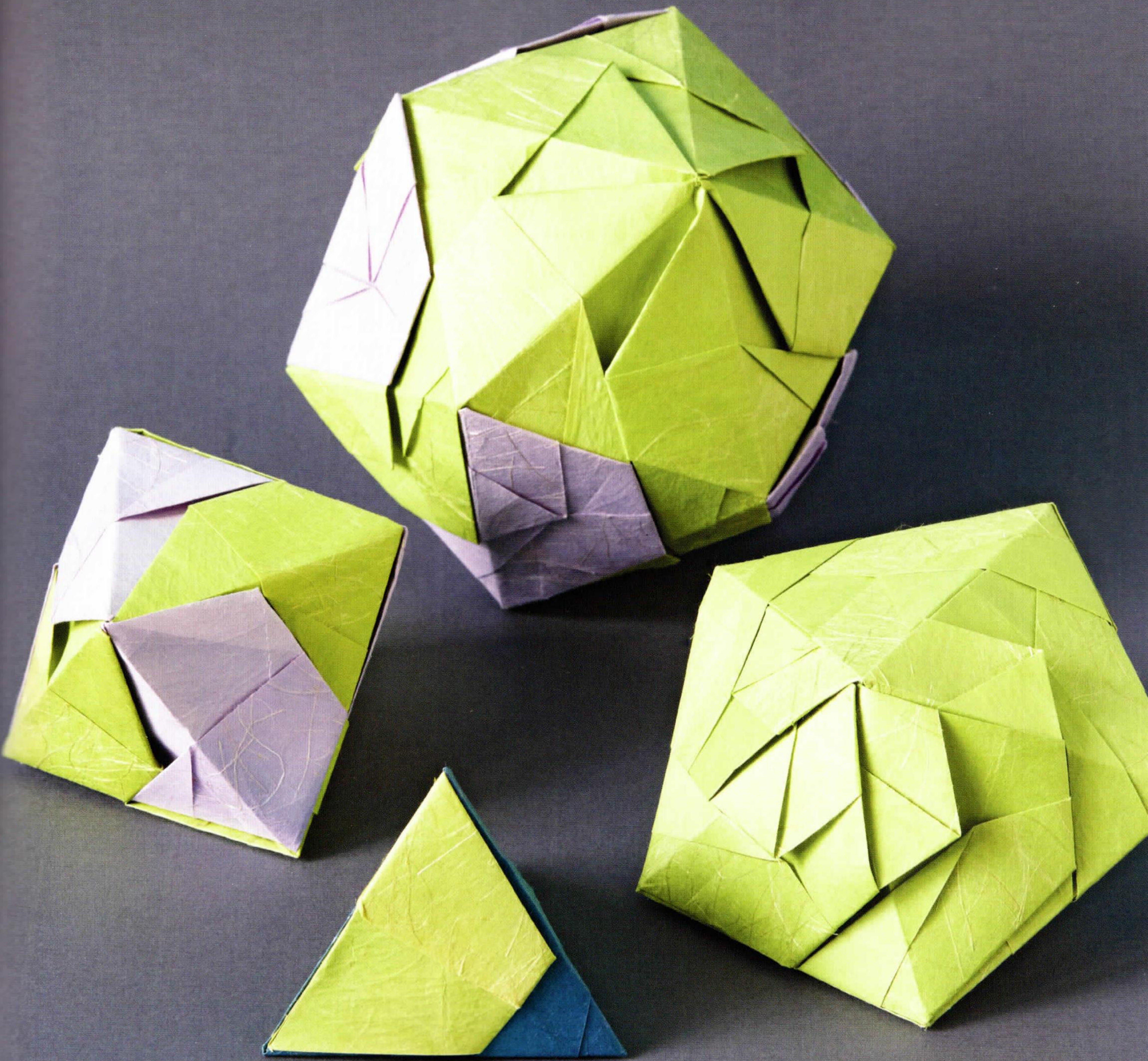

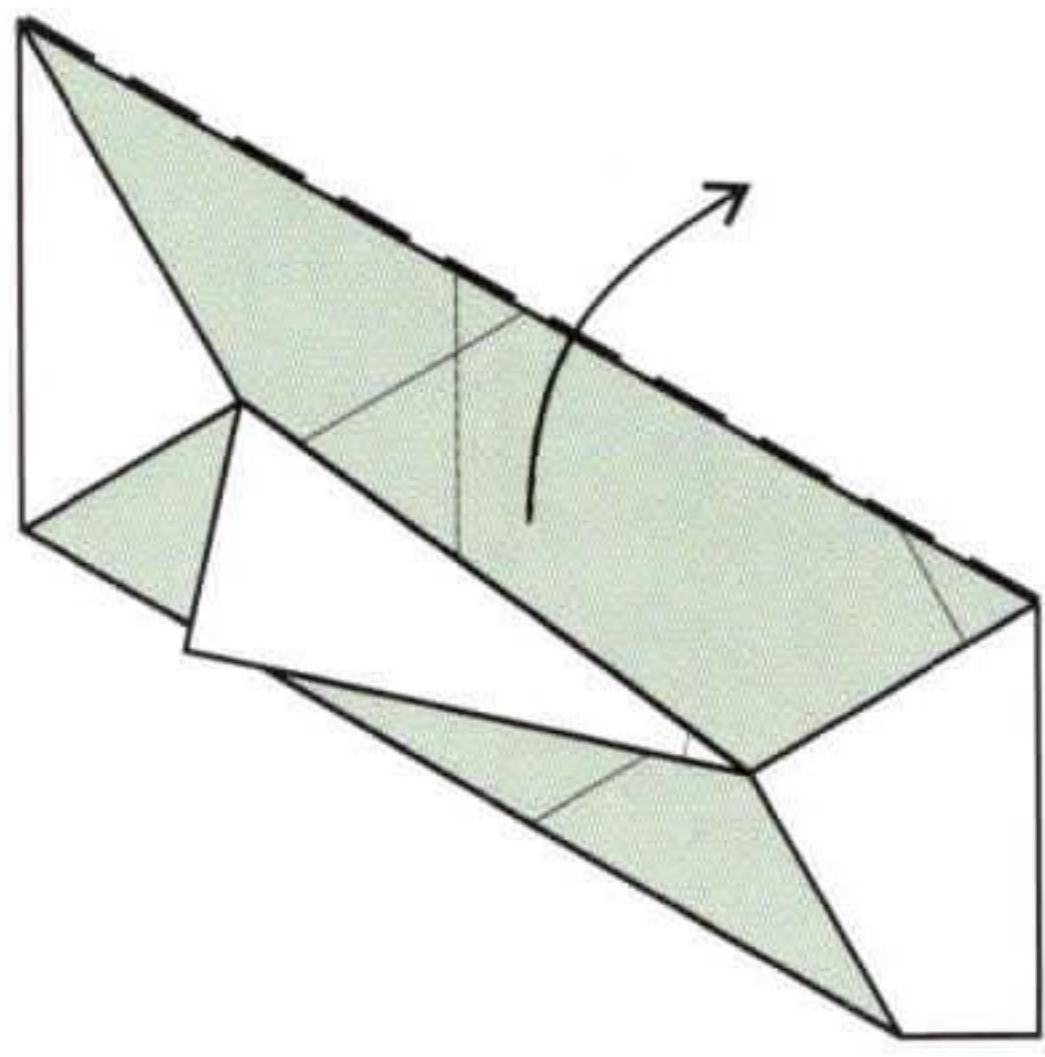

7 Fold the upper section out.

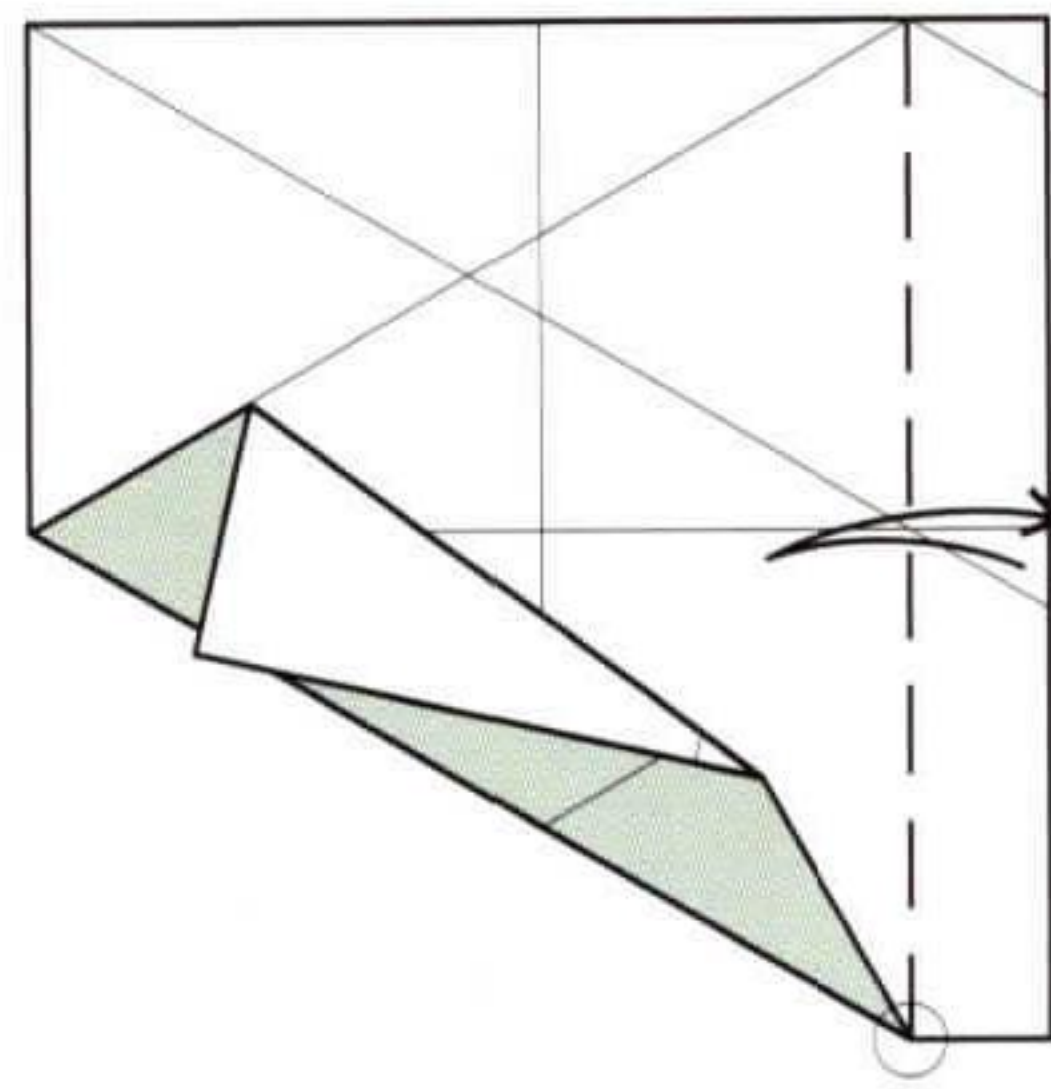

8 Fold the outer edge in at the end of the folded section.

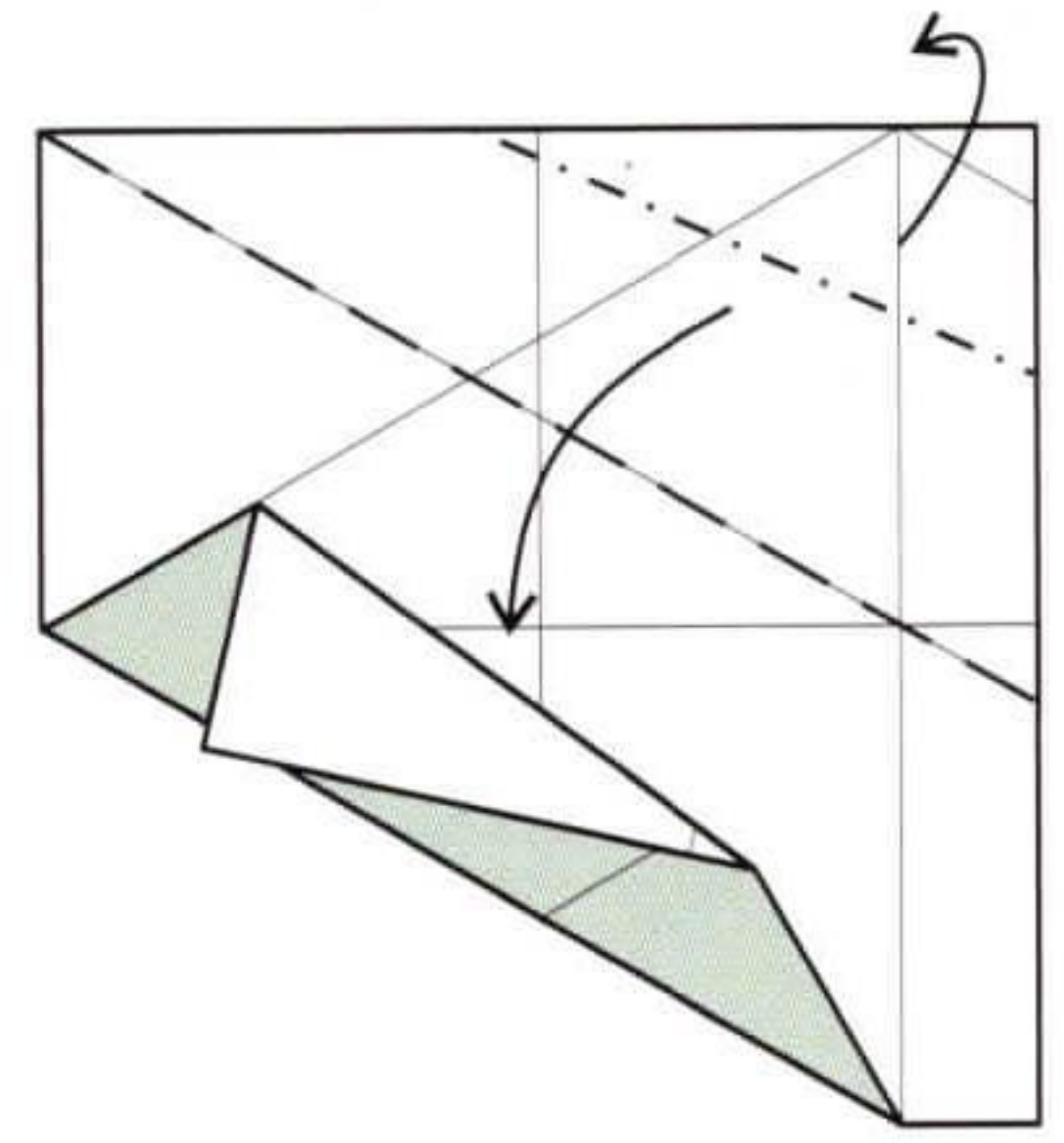

9 Fold the upper corner down along the crease made previously. Then back up.

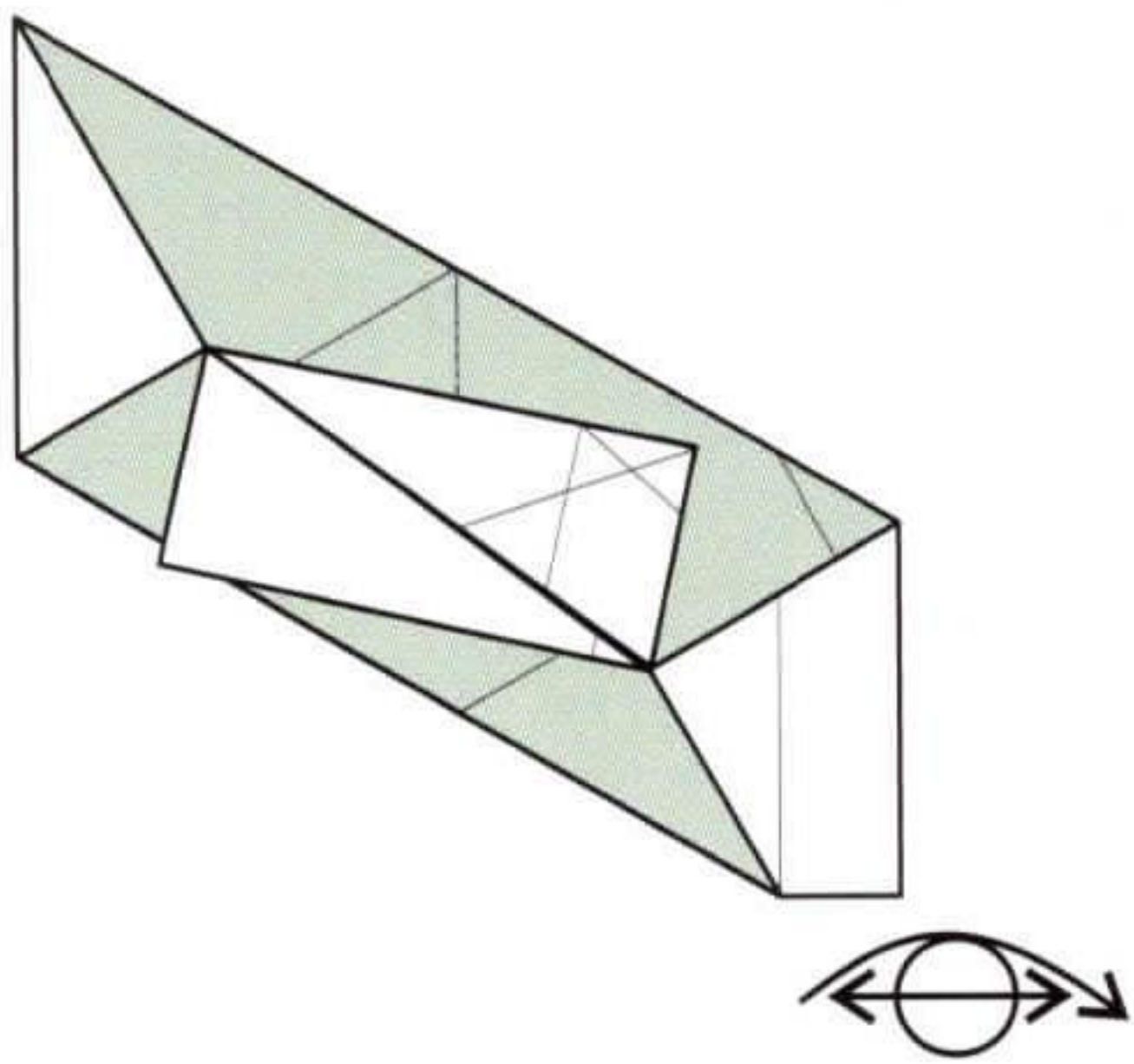

10 Turn the model over left to right.

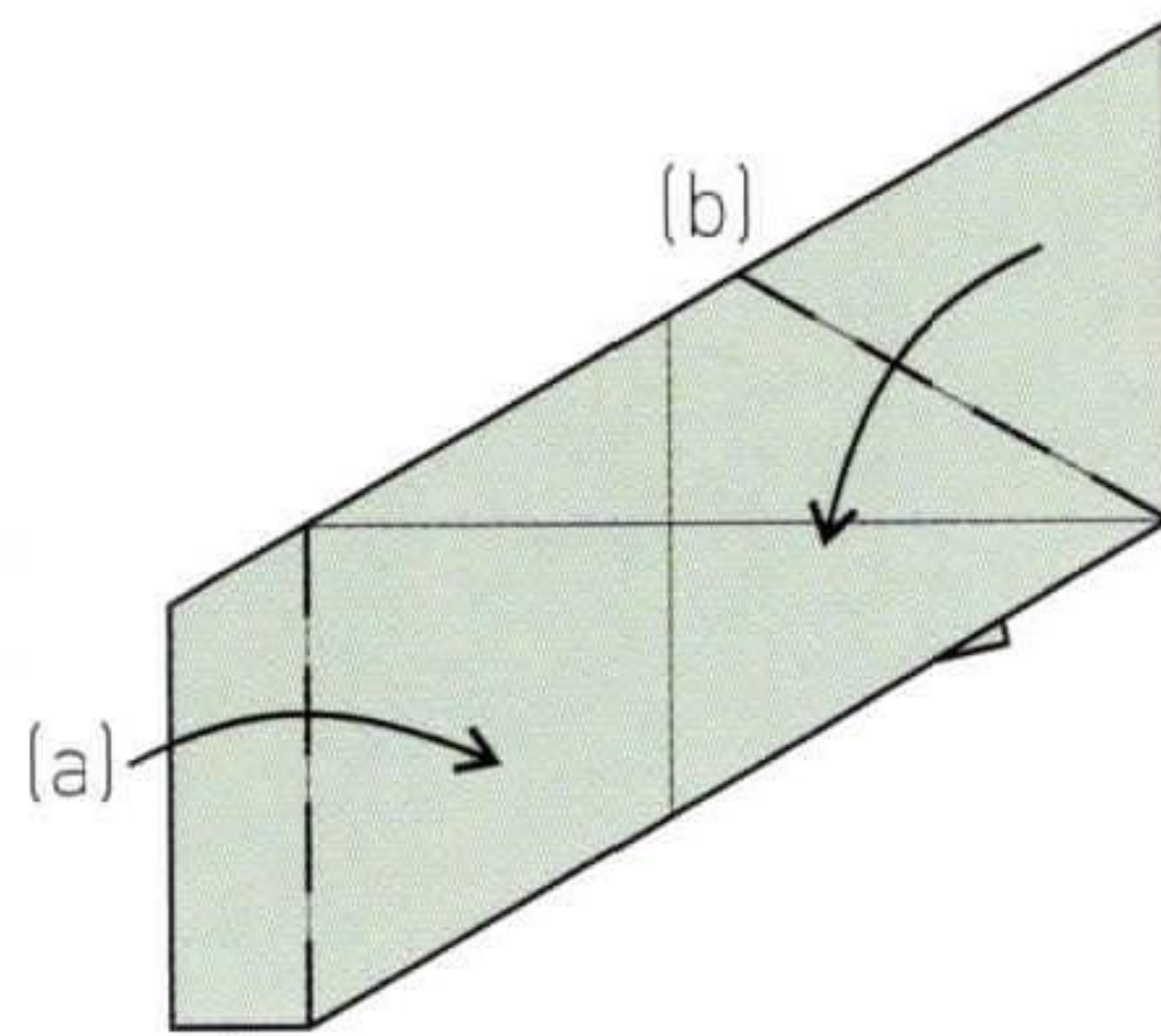

11 (a) Fold the outer edge in along the crease made previously (b). Then fold in the opposite corner.

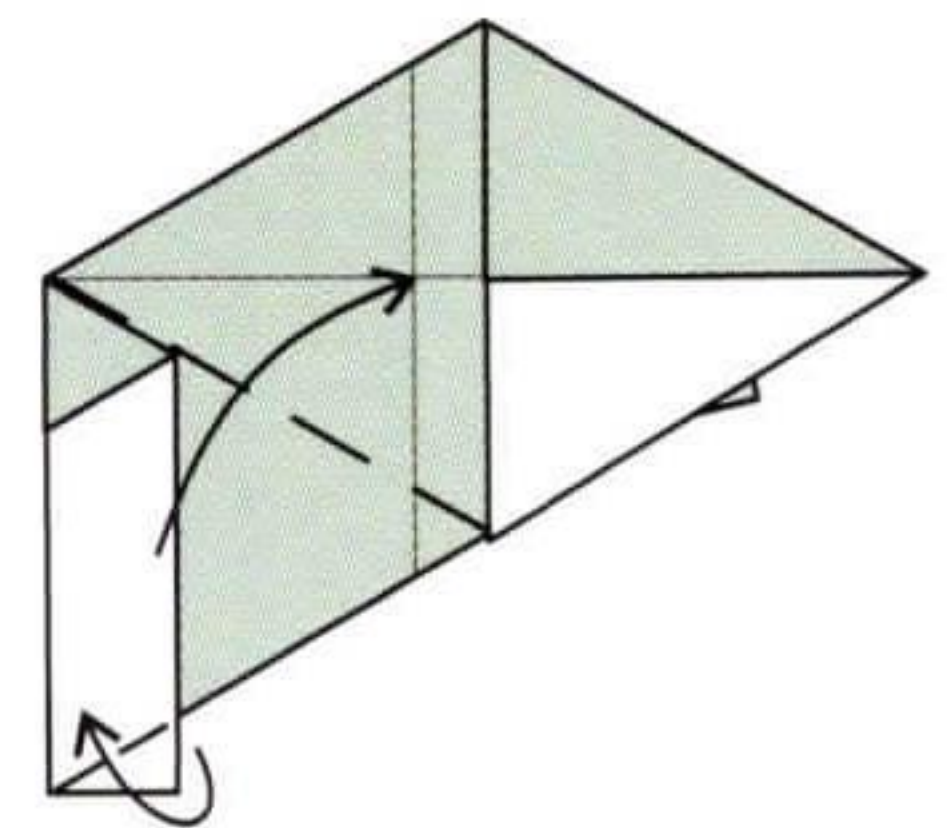

12 Fold the lower corner in. Then fold the lower section up to align the section edge with the edge of the other folded triangle above.

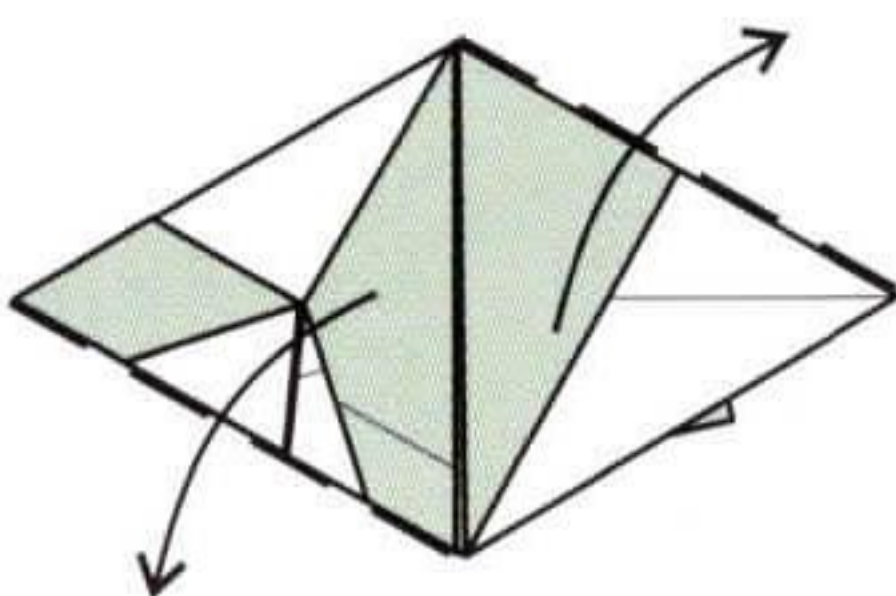

13 Unfold both sides.

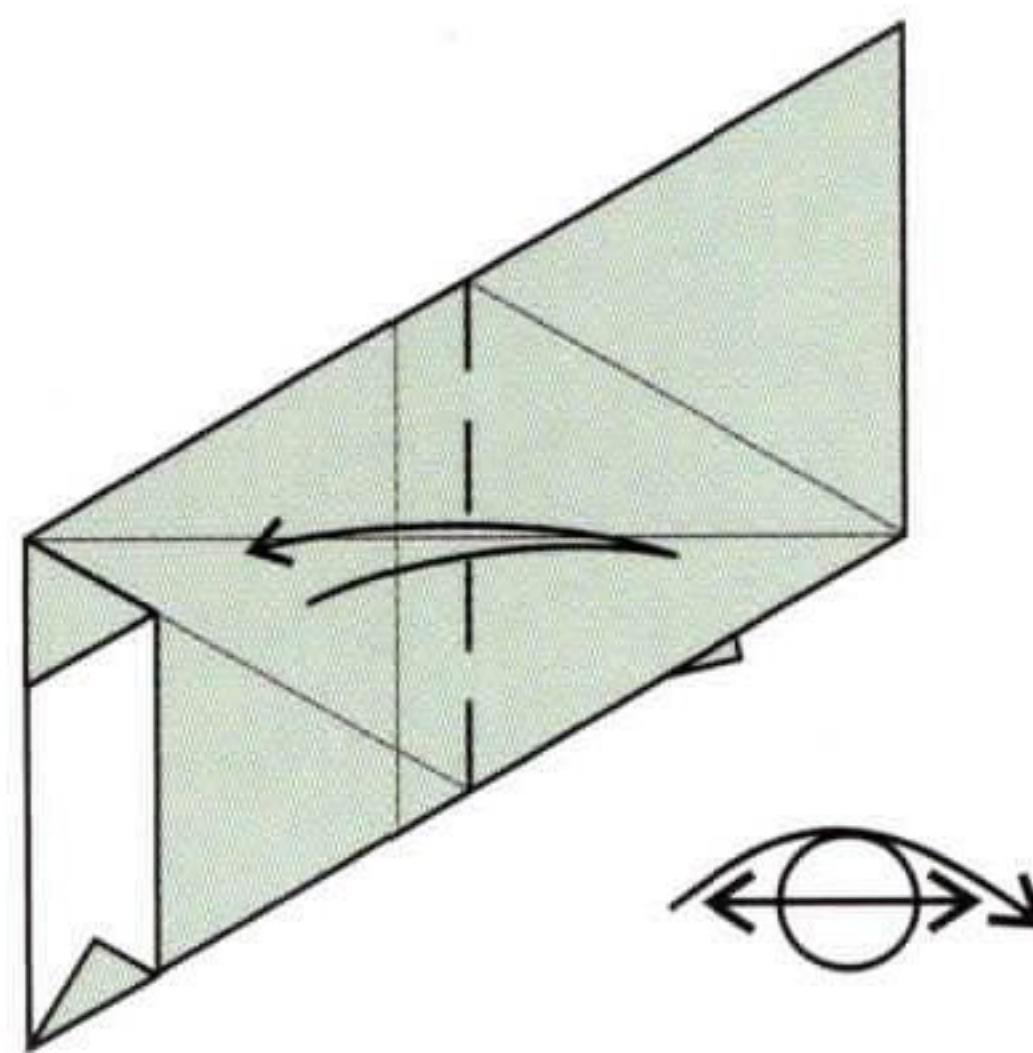

14 Fold and unfold along the middle. Then turn the model over left to right

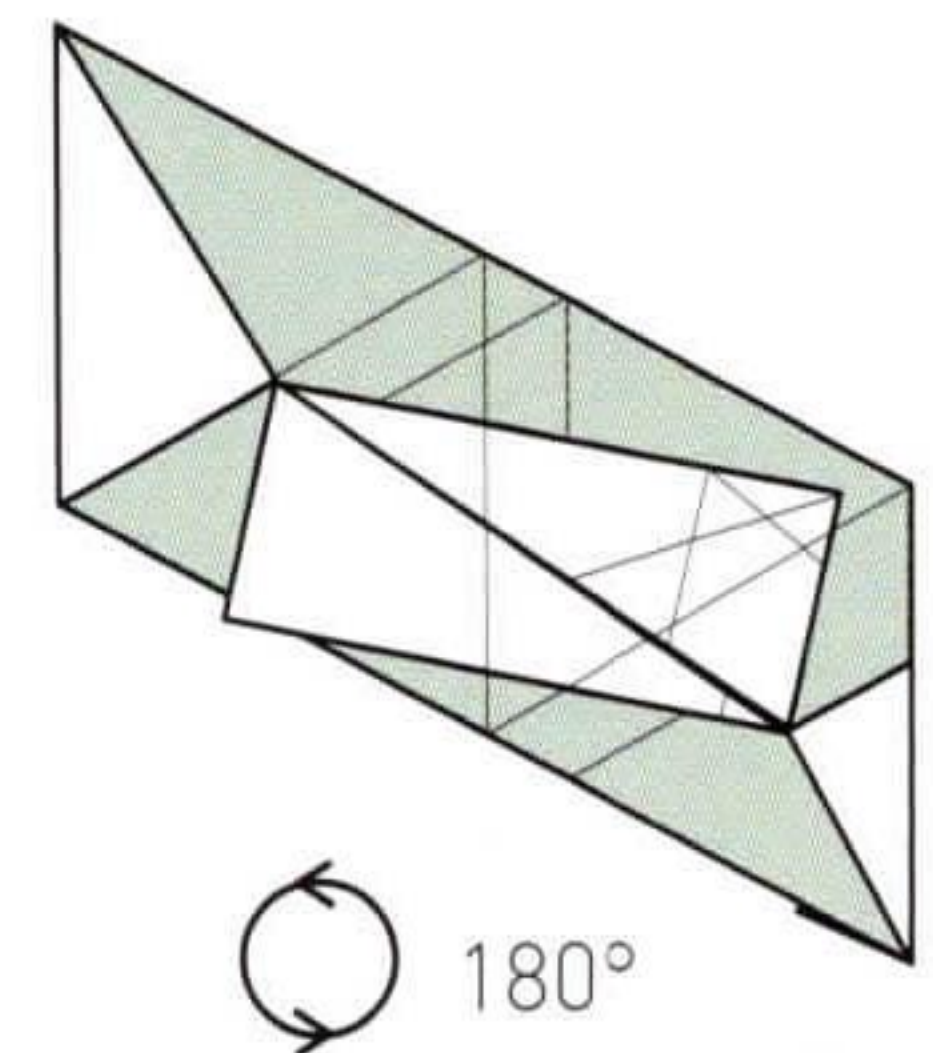

15 Rotate the model by 180°.

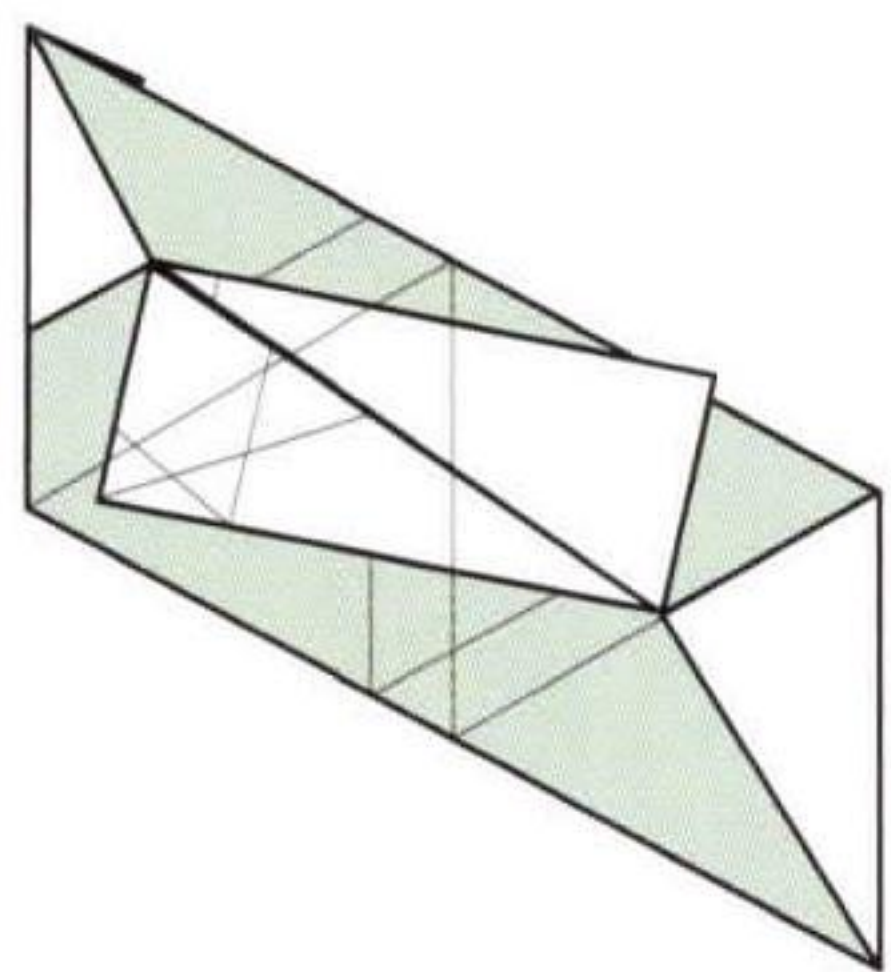

16 Module complete. The ten-unit assembly requires five similar modules and five modules that mirror the module above.

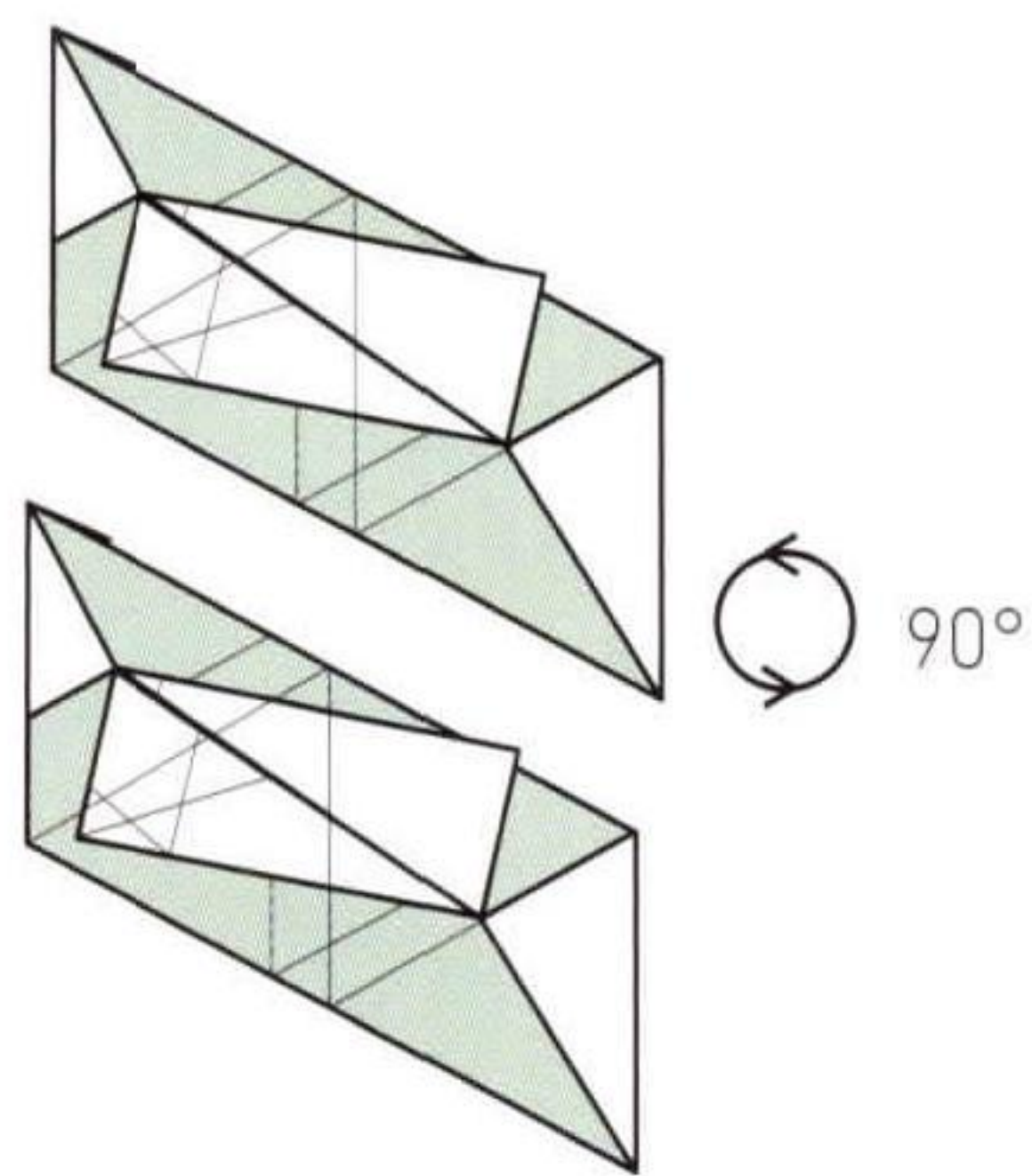

17 Make five similar modules. Start with two and rotate one by 90° .

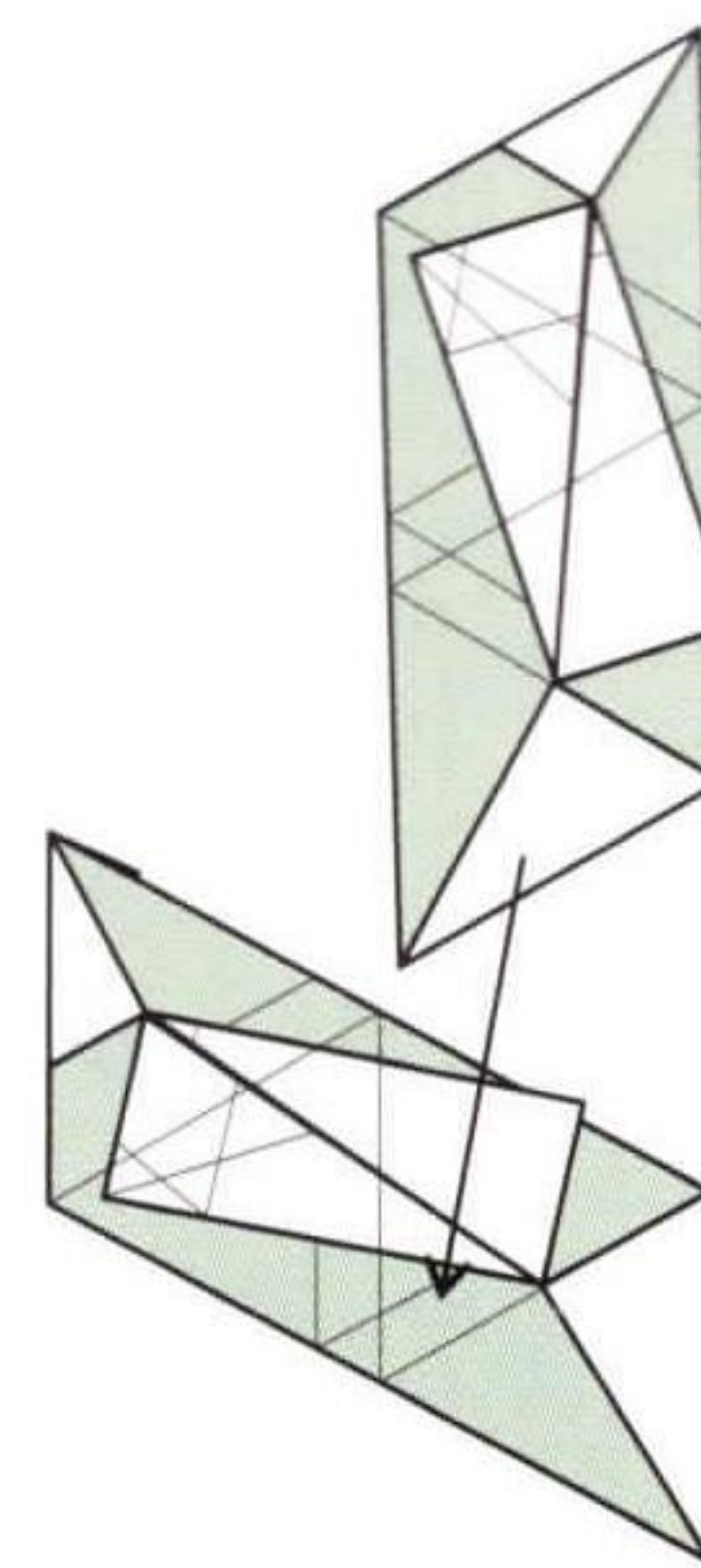

18 Place the corner of one module over the triangular section of the second module.

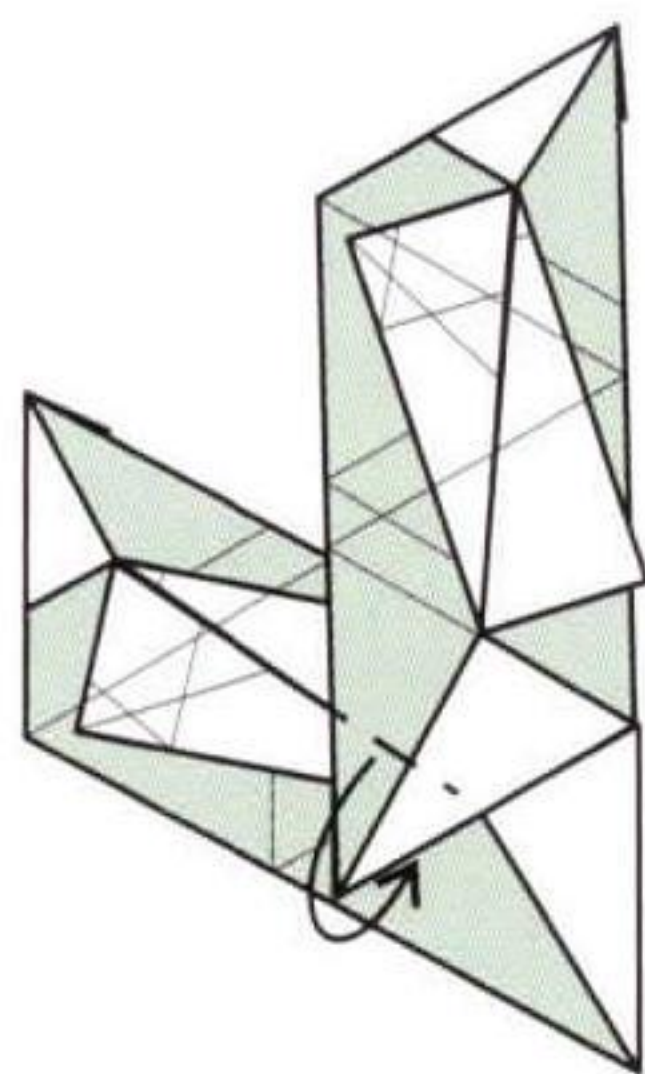

19 Fold the corner of the vertical module behind and beneath the folded edge of the horizontal module.

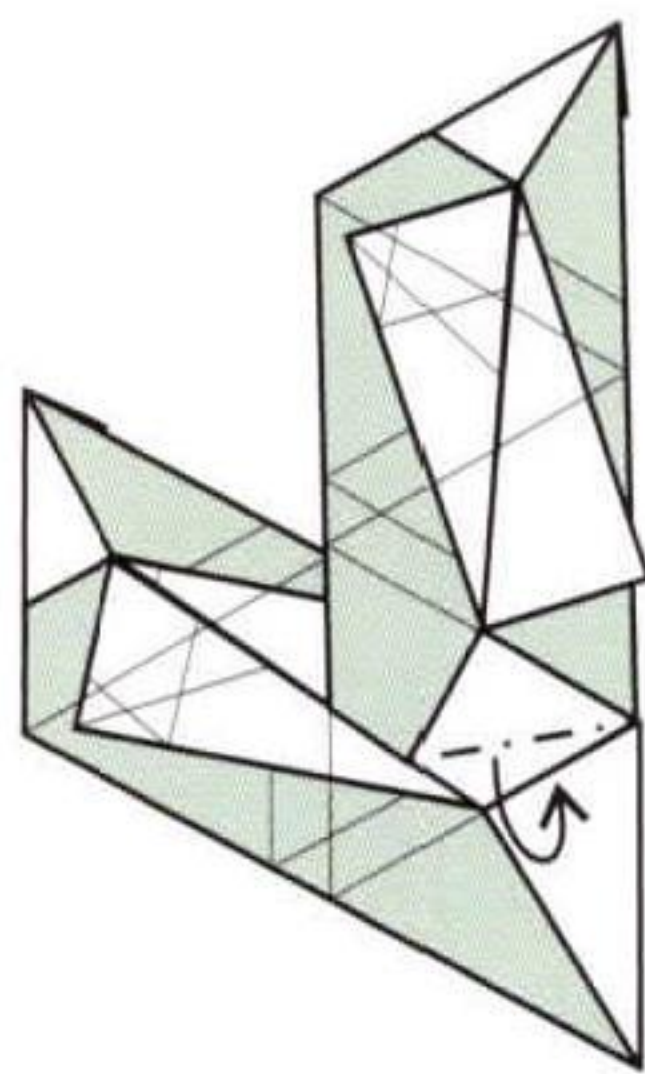

20 Fold the edge of the corner behind to lock the two units together.

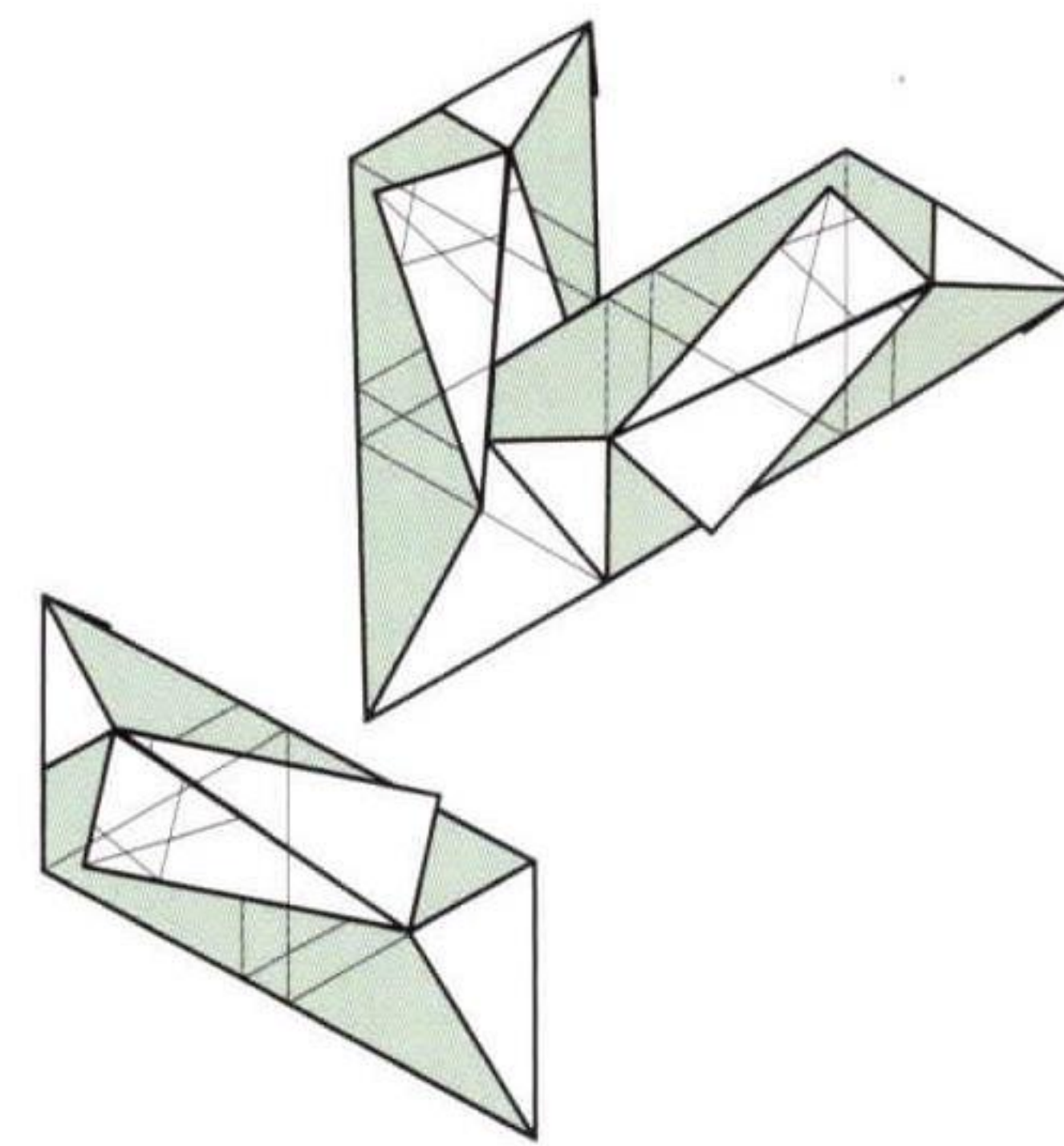

21 Rotate the joined modules and add a third and fourth module. Repeat the connecting process.

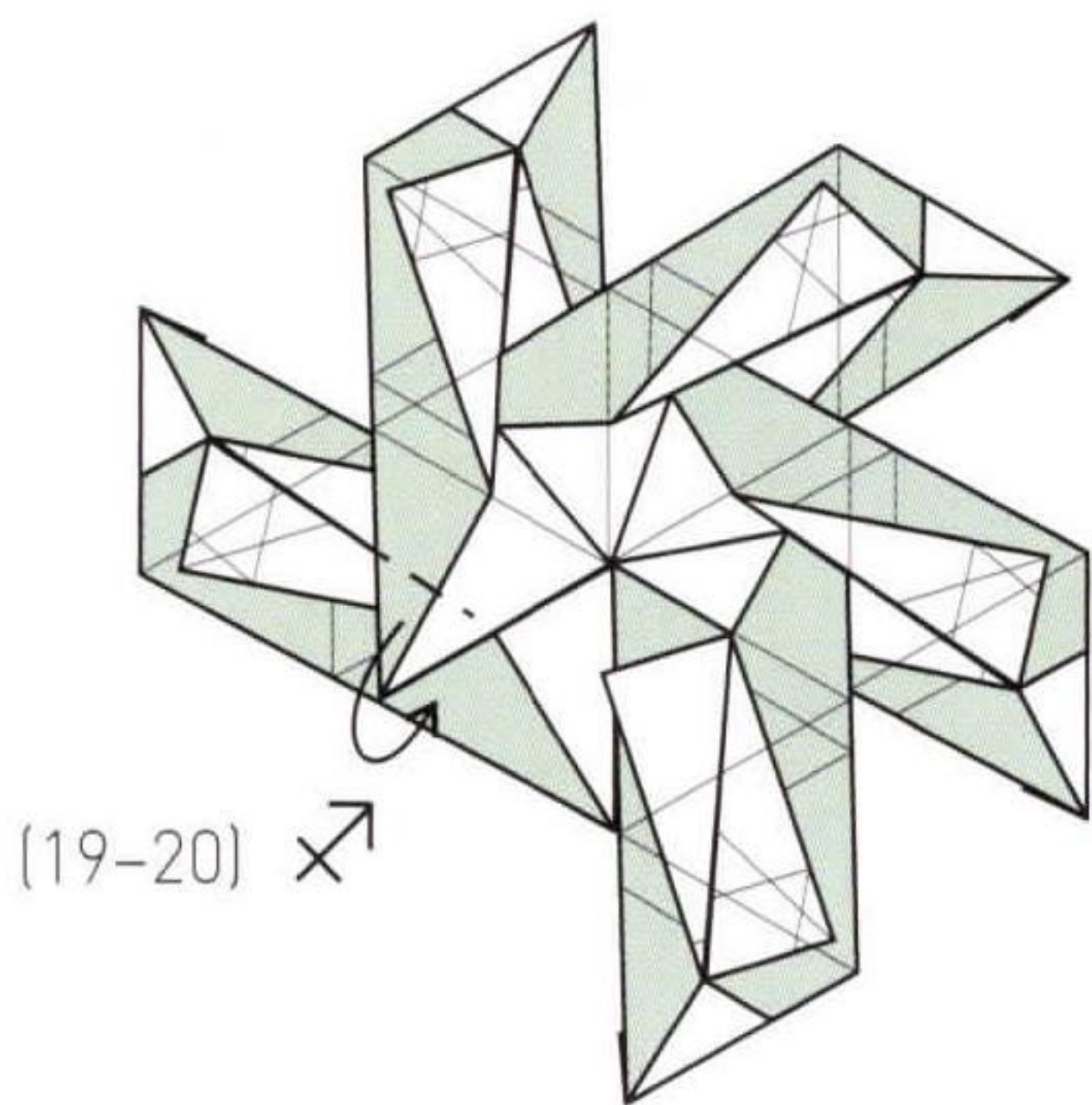

(19-20) ↗

22 Add a fifth unit and repeat steps 19 to 20 to link it.

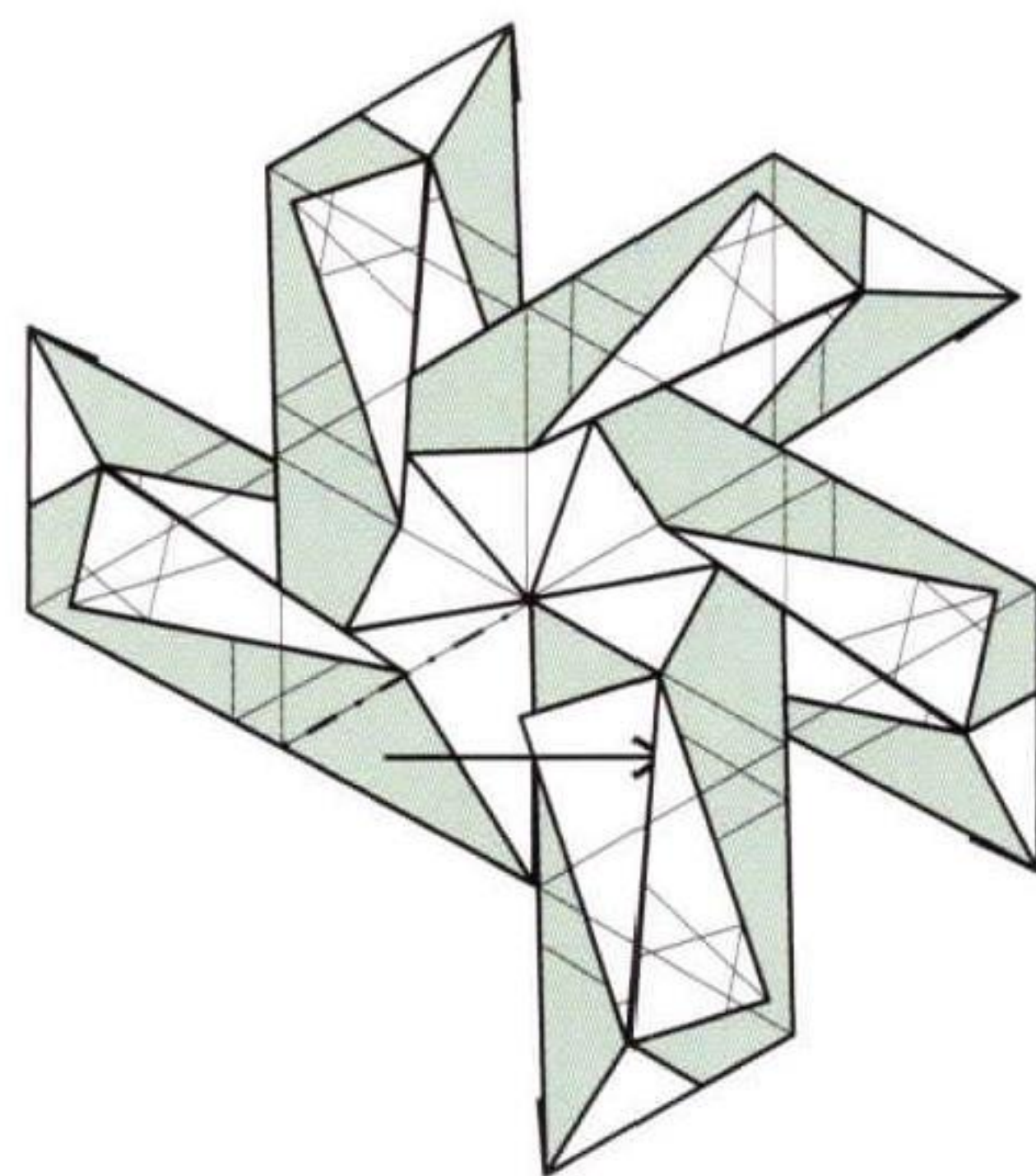

23 Insert the triangular point of the fifth unit into the matching space on the first unit, then repeat the linking process.

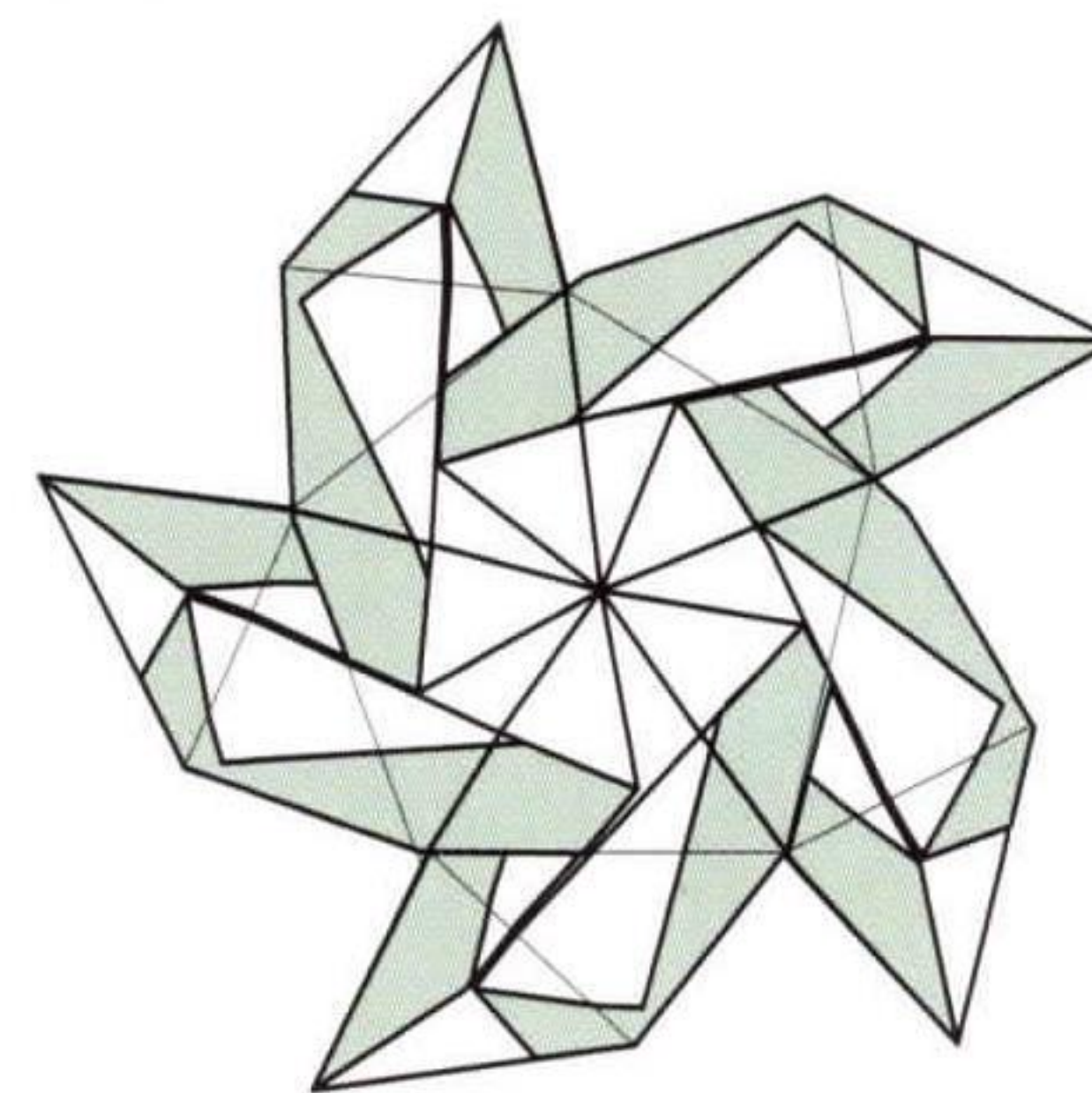

24 Five-unit assembly. This can be made into a 10-sided shape by turning the model over and joining the triangular points to a mirror image.

TO COMPLETE THE ICOSAHEDRON MAKE FIVE MORE MODULES THAT SHOULD MIRROR THE FIRST FIVE. FOR EACH OF THE FIVE UNITS START WITH A SQUARE, COLOURED SIDE UP, AND REPEAT STEPS 1 TO 2 OF THE STANDARD MODULE.

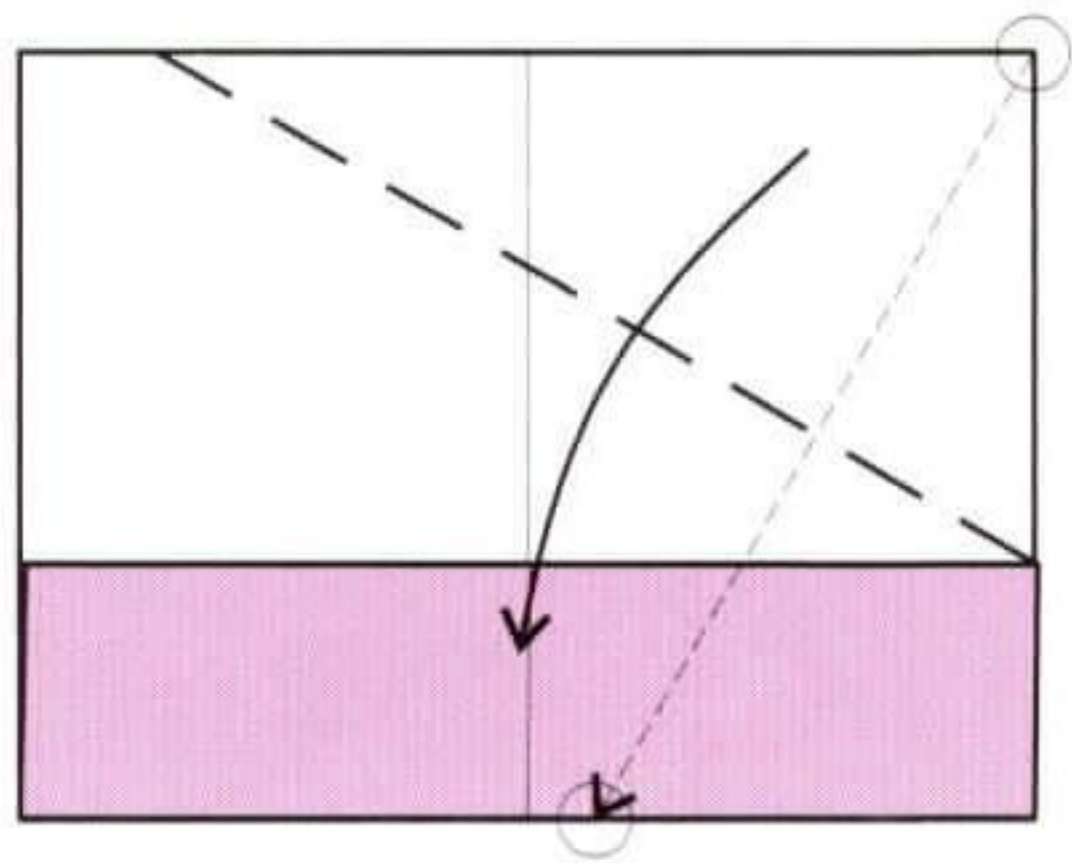

- 1 Fold the upper right corner down to touch the lower folded edge. This is the opposite corner to the first unit.

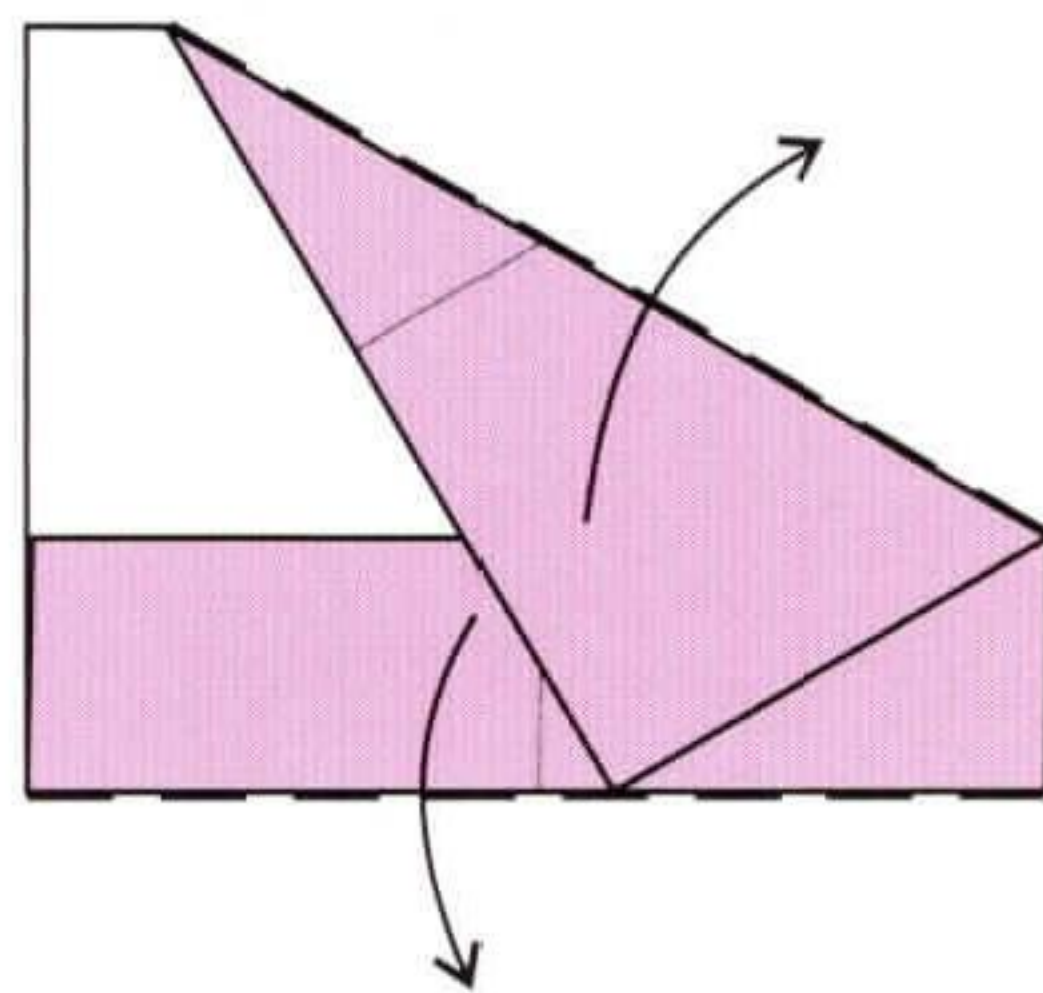

- 2 Unfold back to a square.

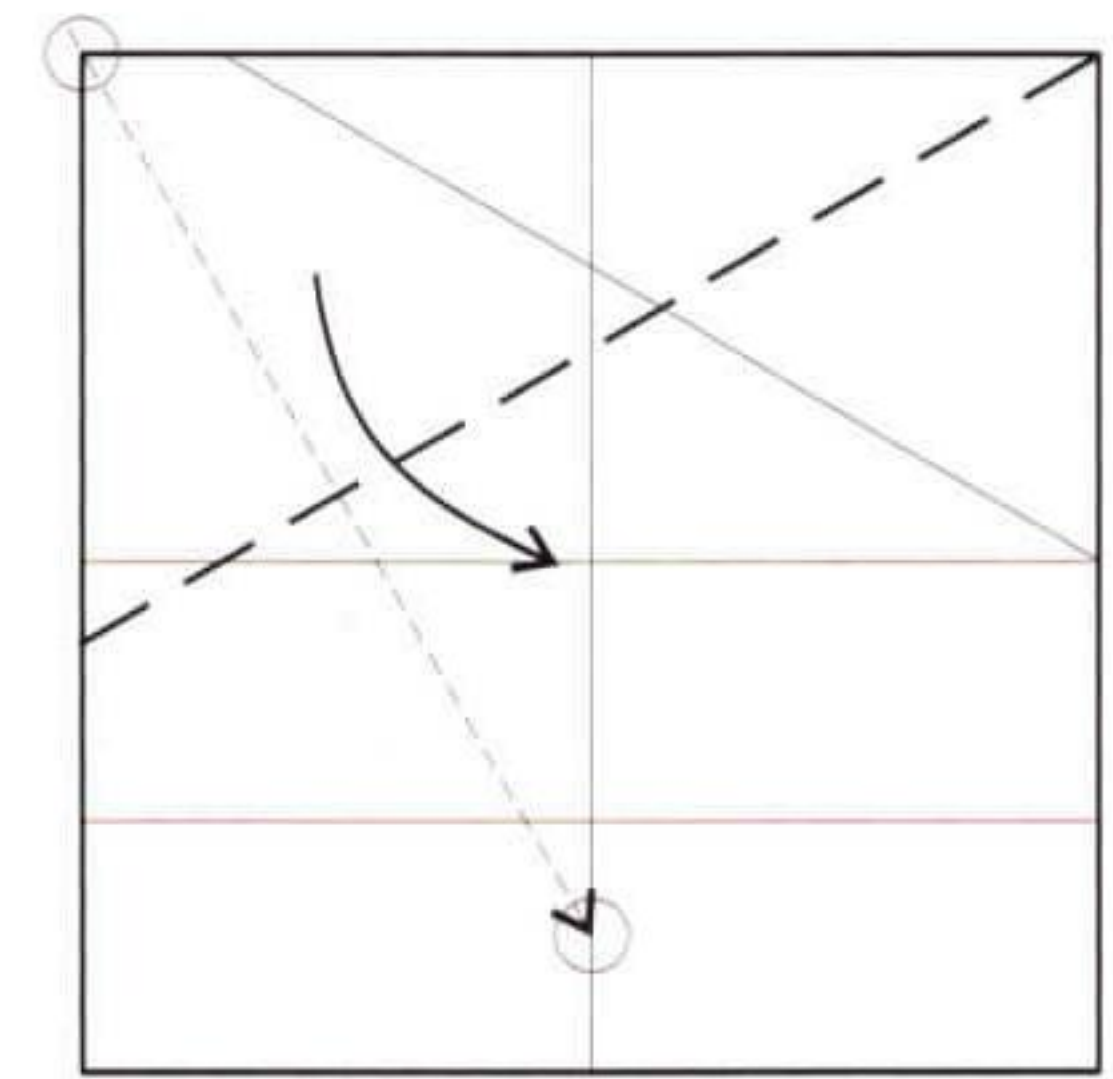

- 3 Fold the upper left corner in to touch the middle crease.

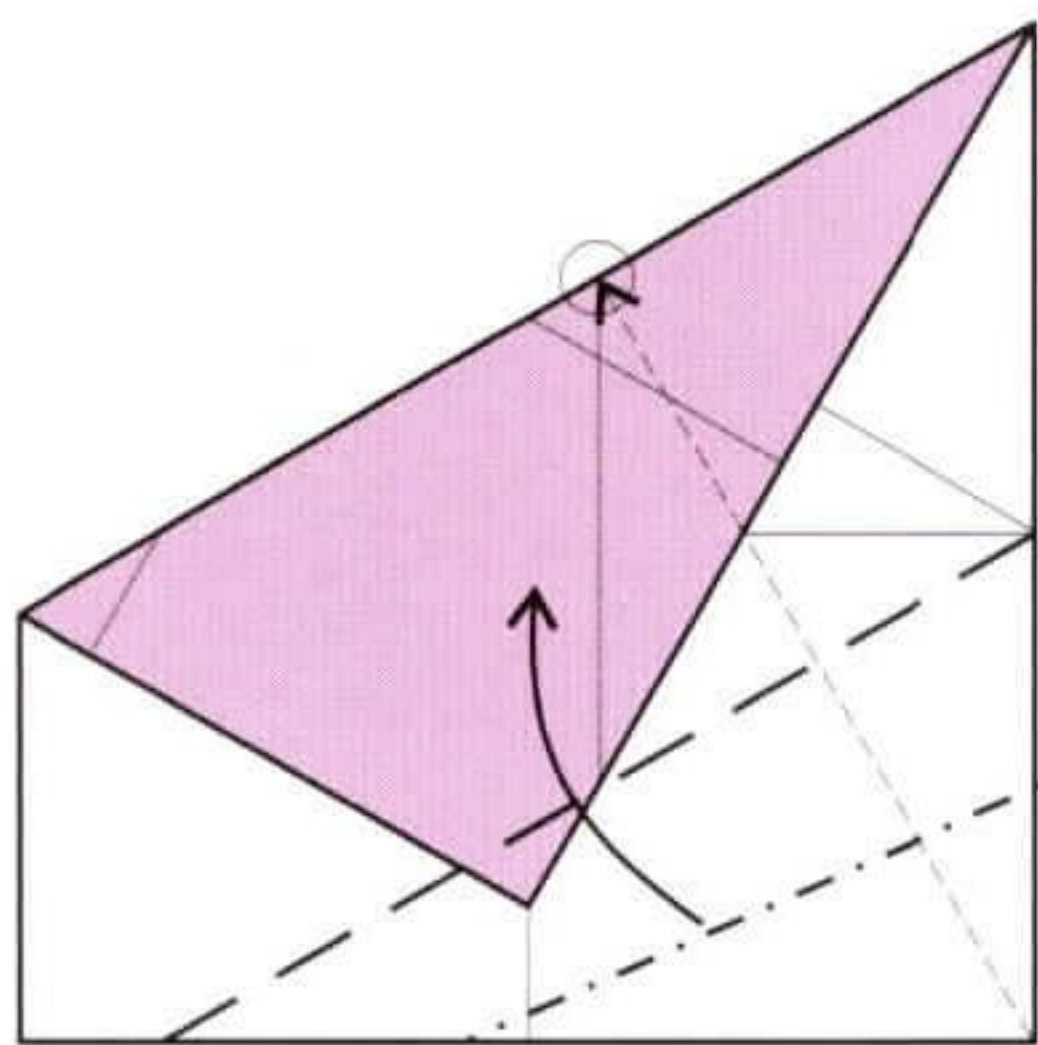

- 4 Fold the lower right corner up to touch the crease in the folded edge above. Then fold the section back again.

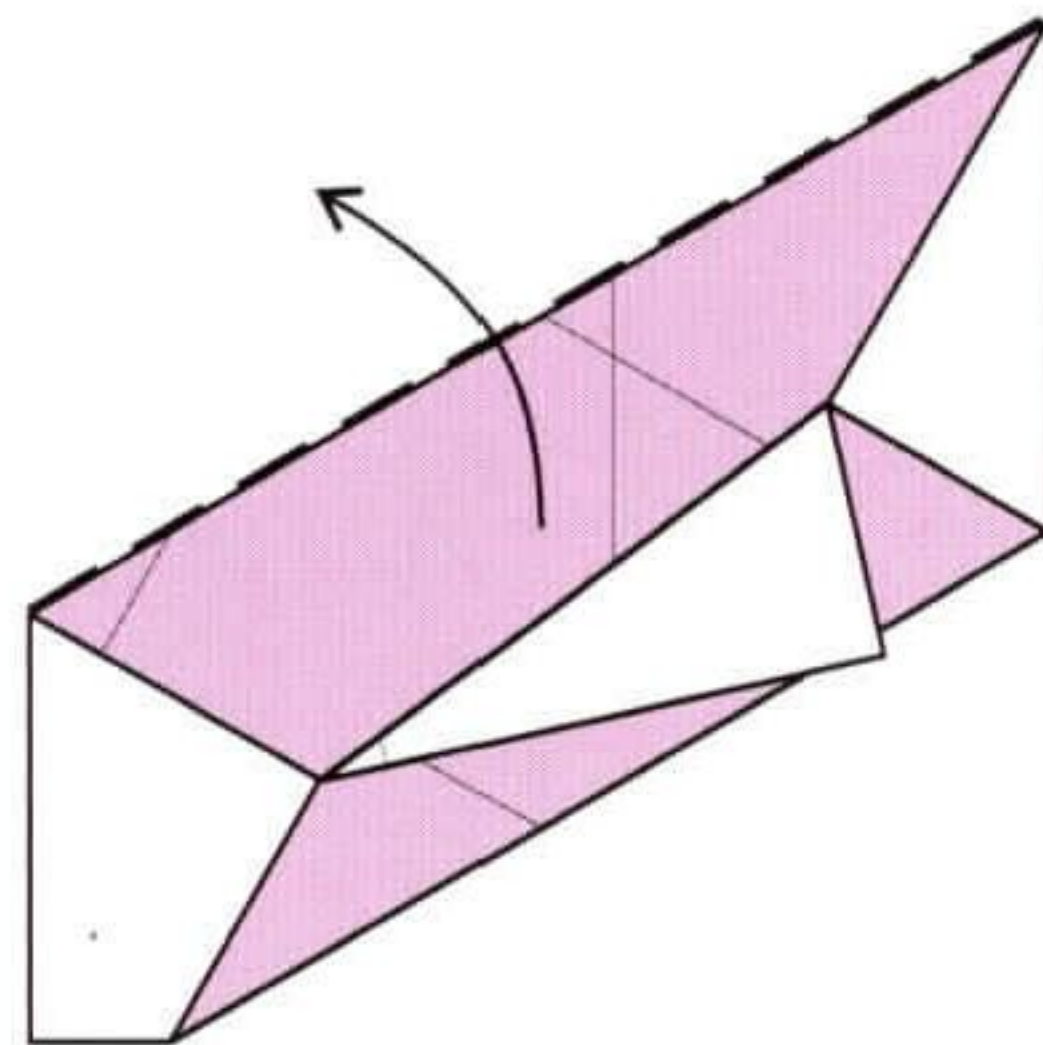

- 5 Fold the upper section out.

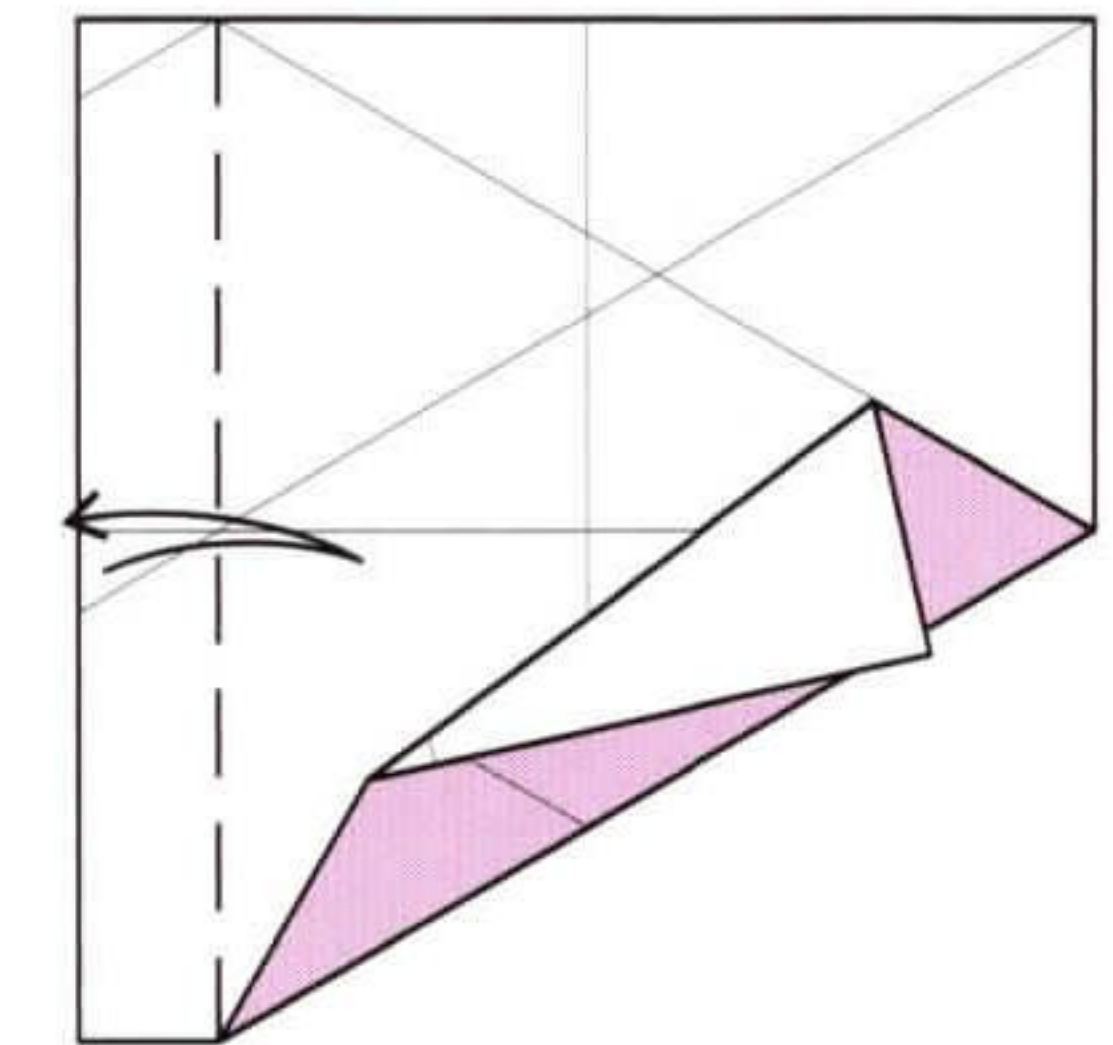

- 6 Fold the left edge over at the point where the lower fold starts, and then unfold it again.

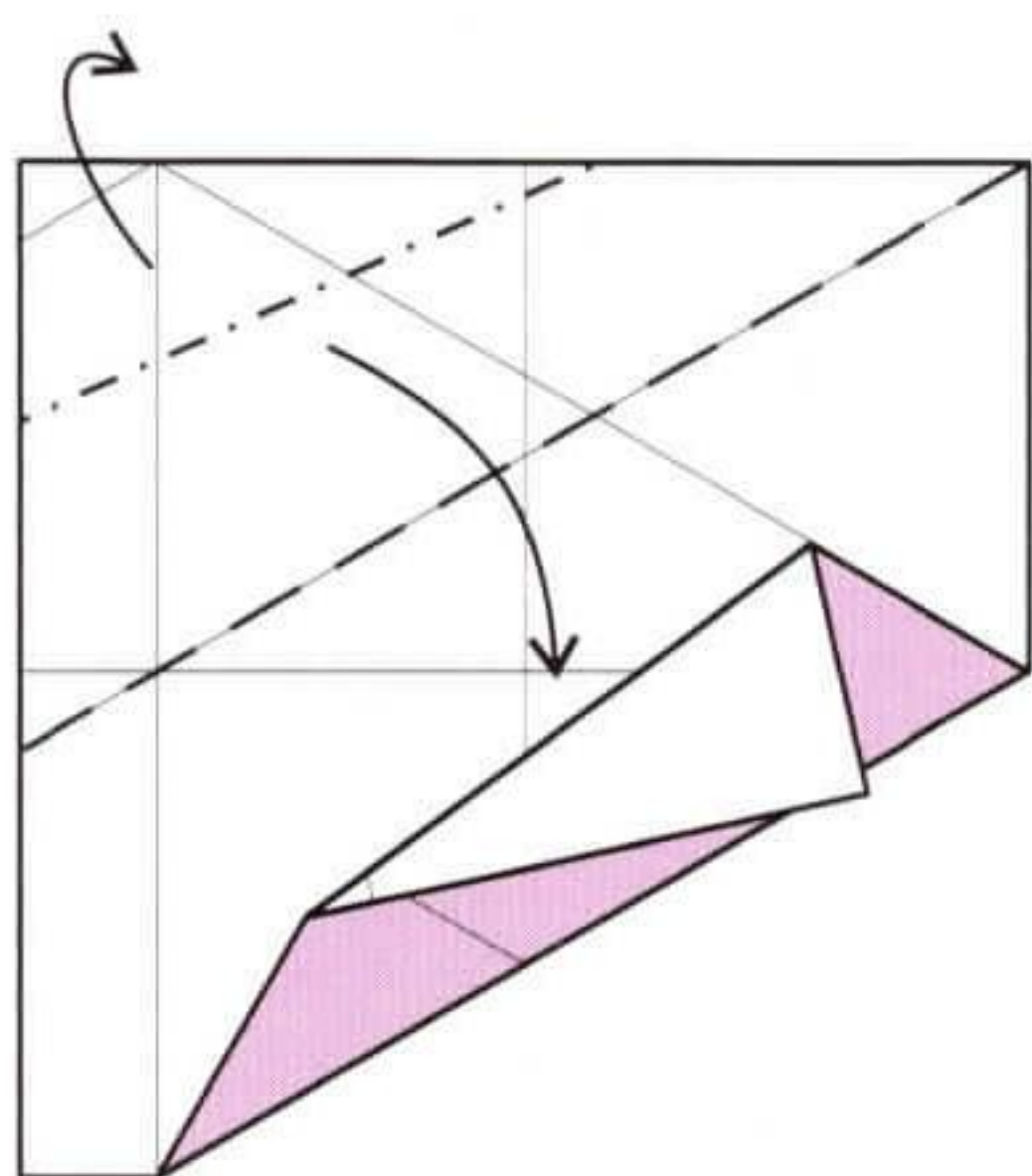

- 7 Fold the upper left corner down along the crease made previously.

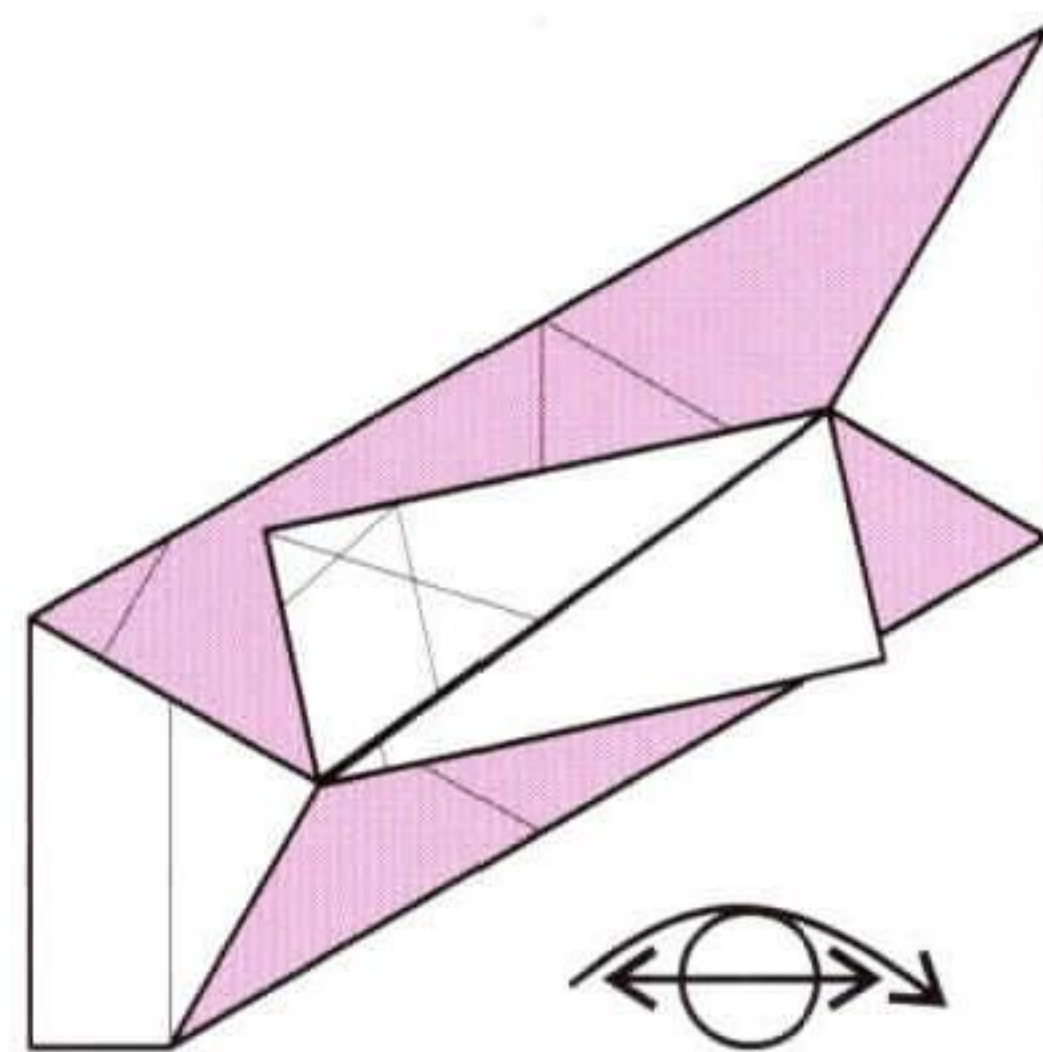

- 8 Turn the model over left to right.

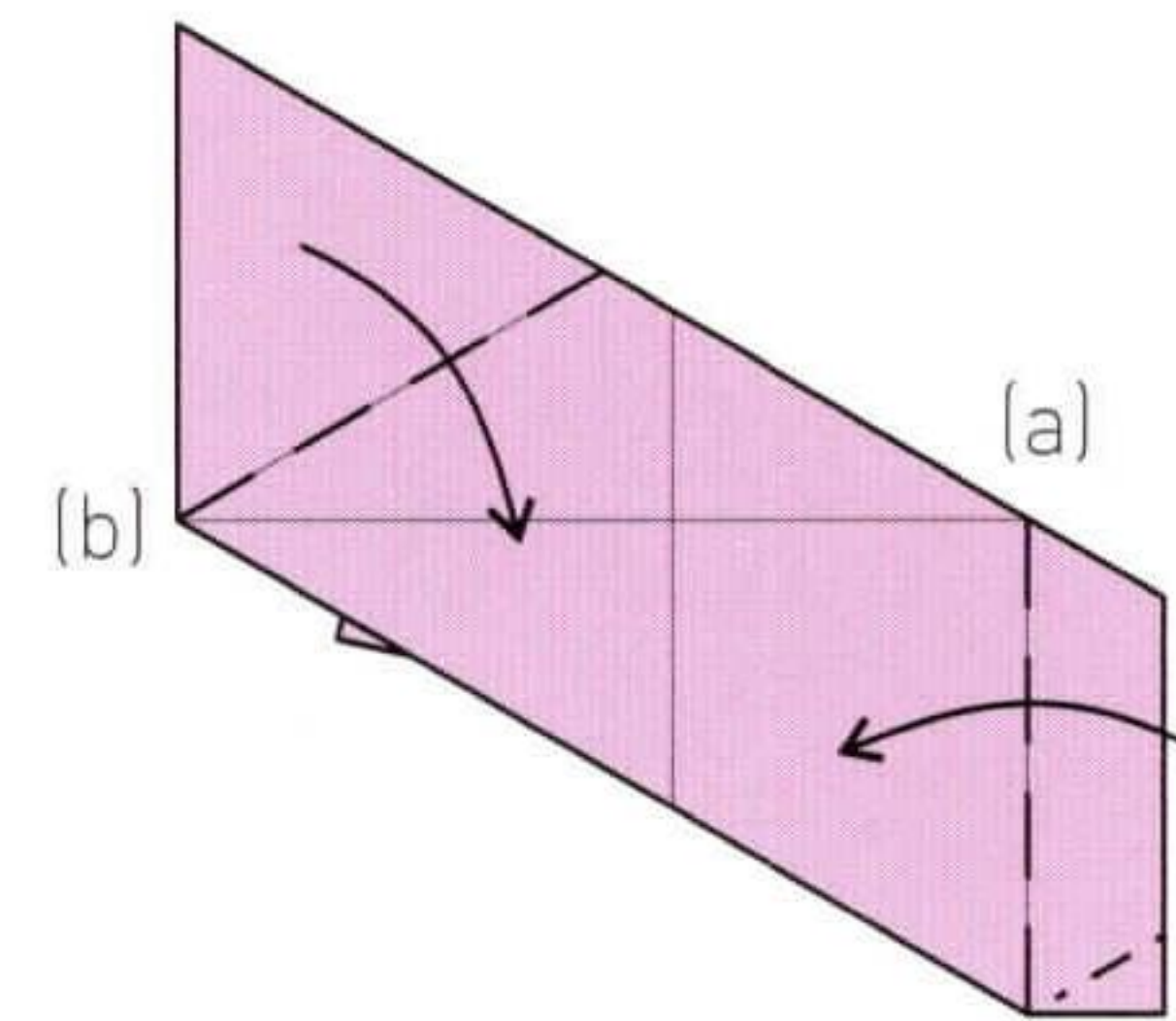

- 9 Fold the outer edge in along the crease made previously (a). Then fold in the opposite side and fold in the lower corner (b).

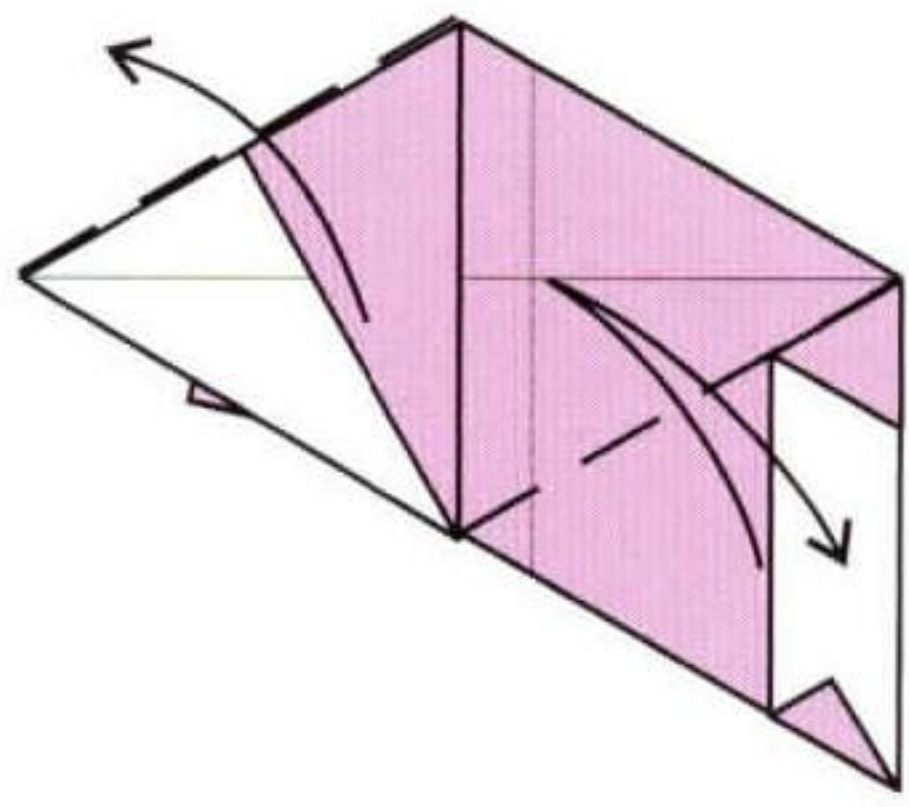

- 10 Fold and unfold the lower corner, then fold the upper section out.

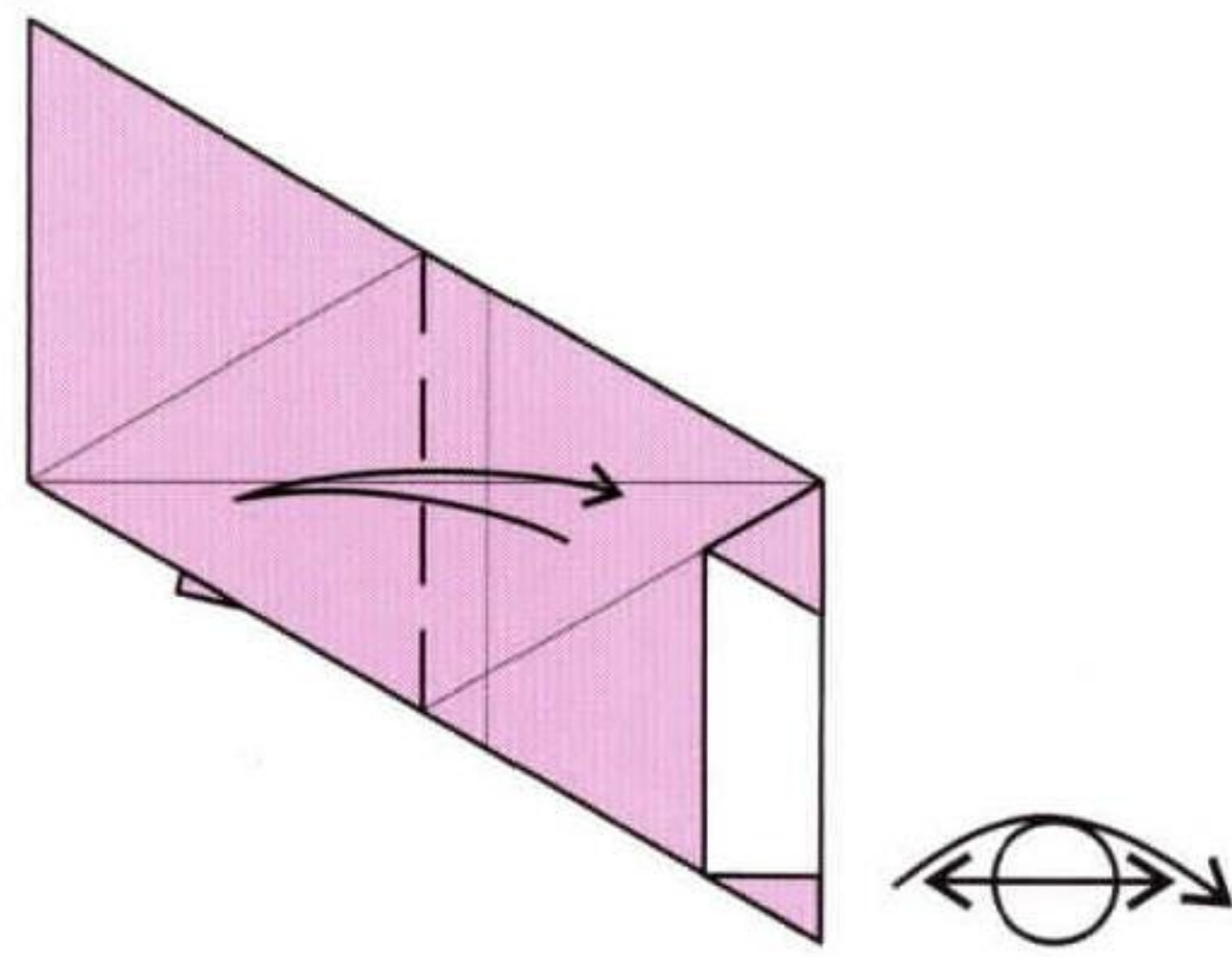

- 11 Fold and unfold along the middle. Then turn the model over left to right.

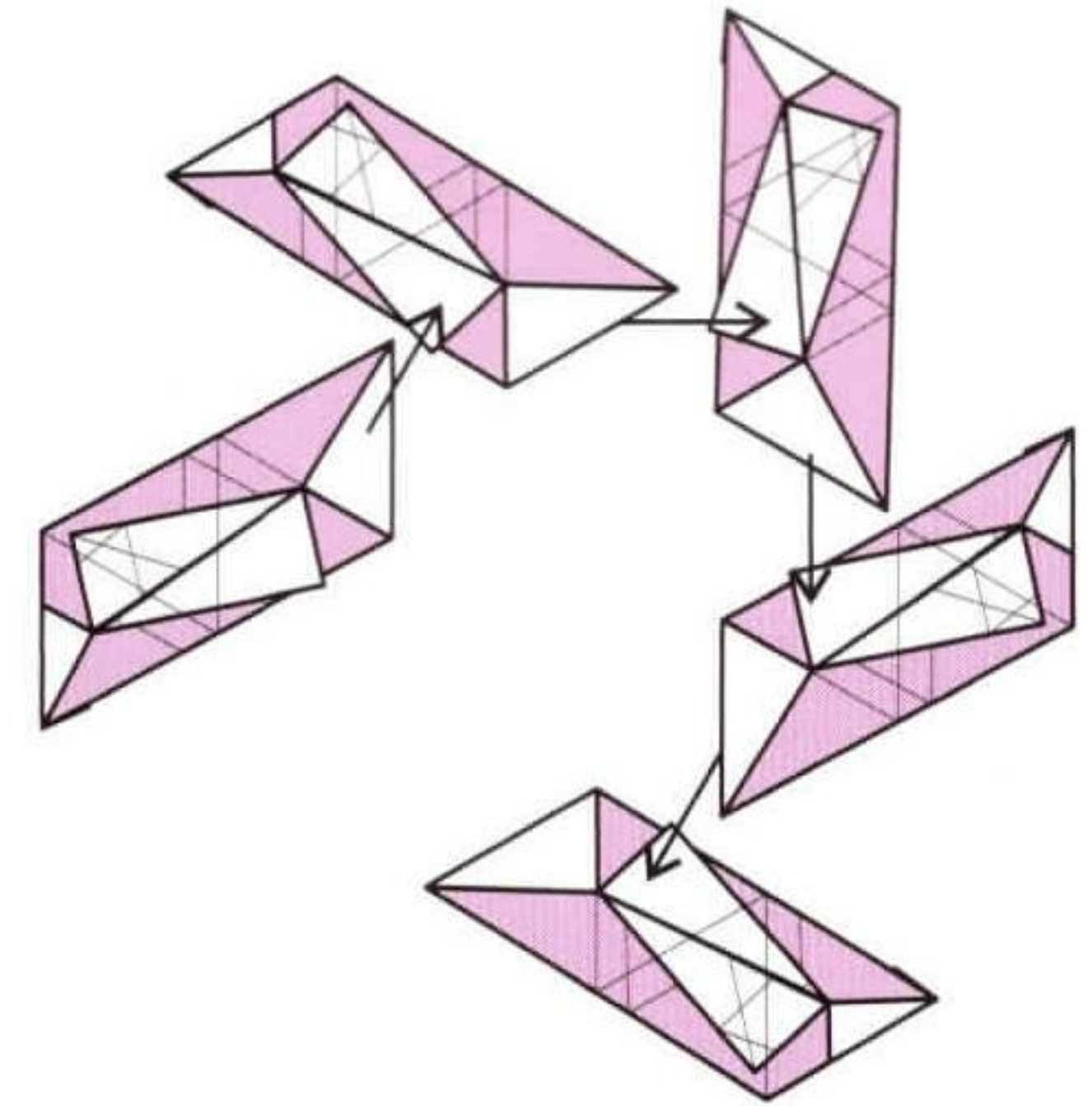

- 12 Assemble the five modules in a similar way to the first five (see page 107).

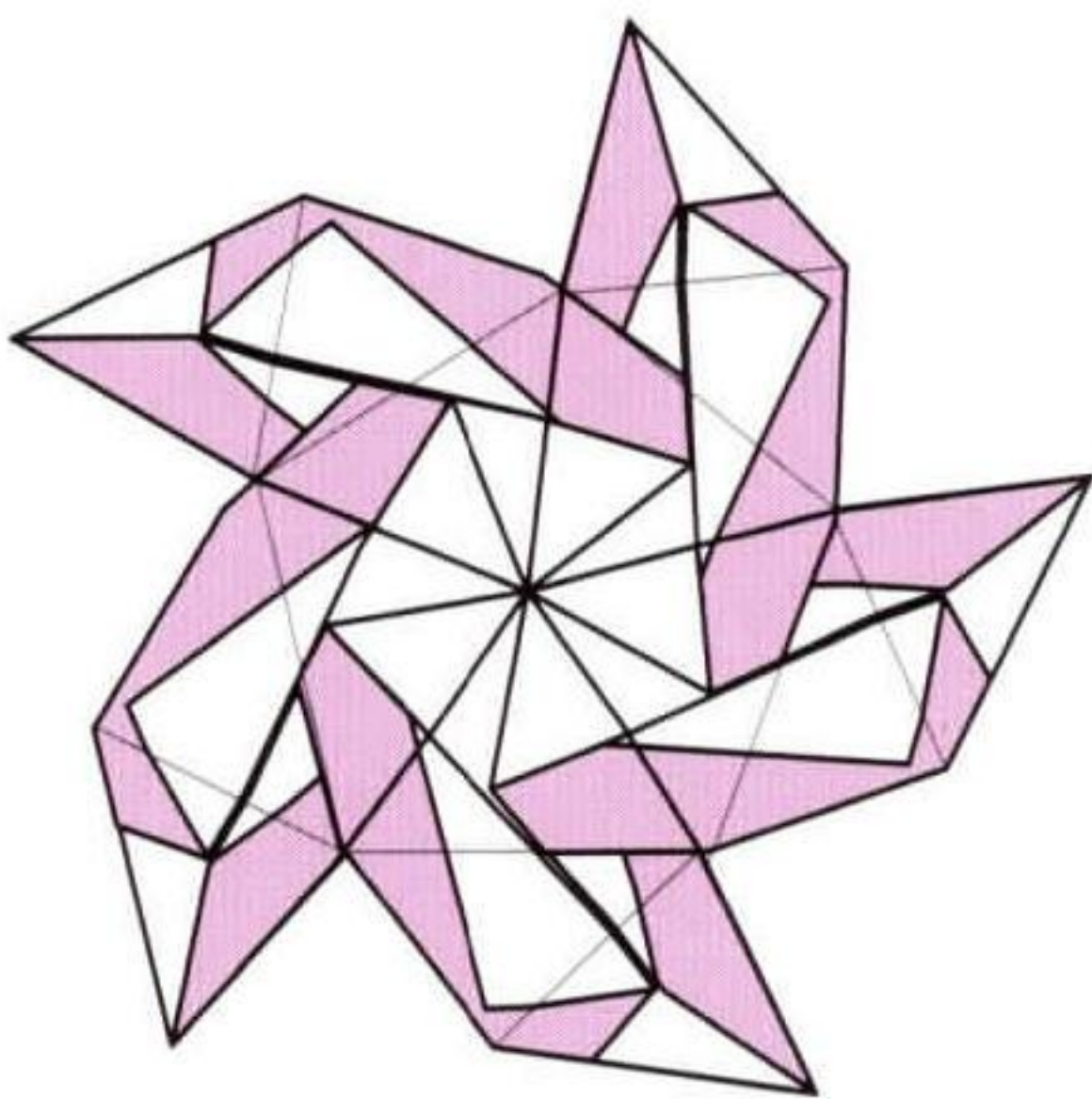

- 13 Module complete.

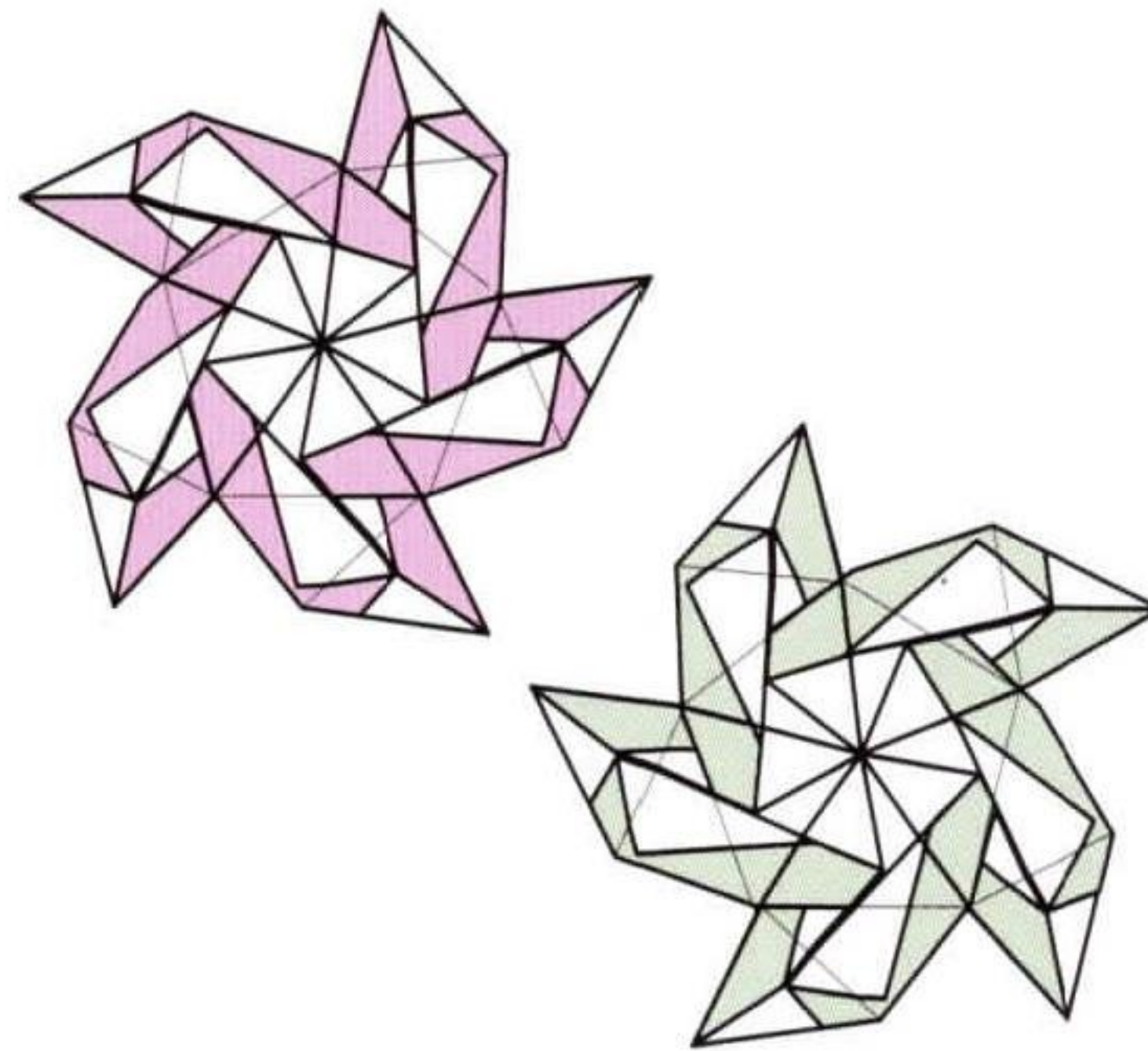

- 14 To form the icosahedron, start with two modules, one a mirror image of the other. Turn one over.

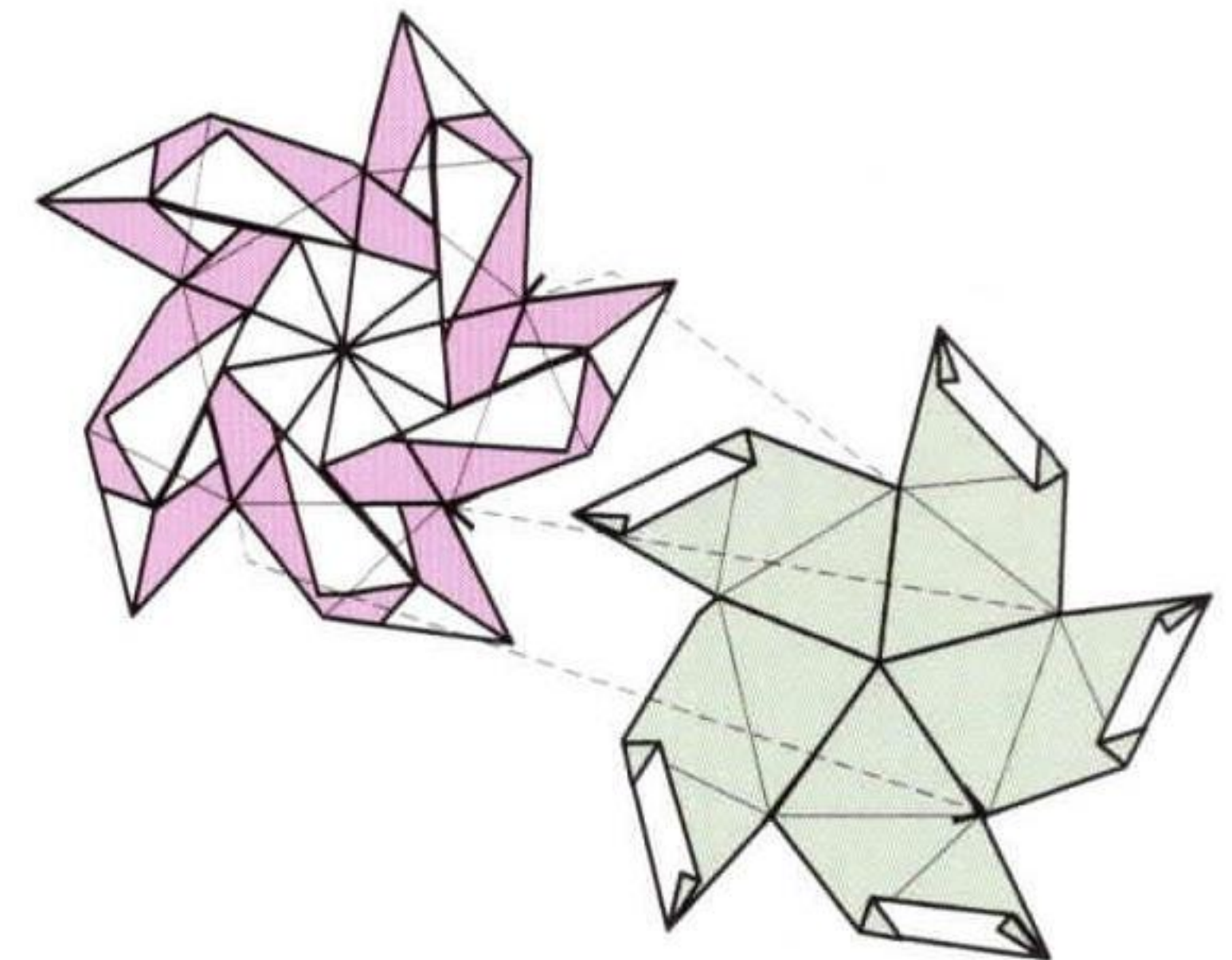

- 15 Align the two modules and bring them together.

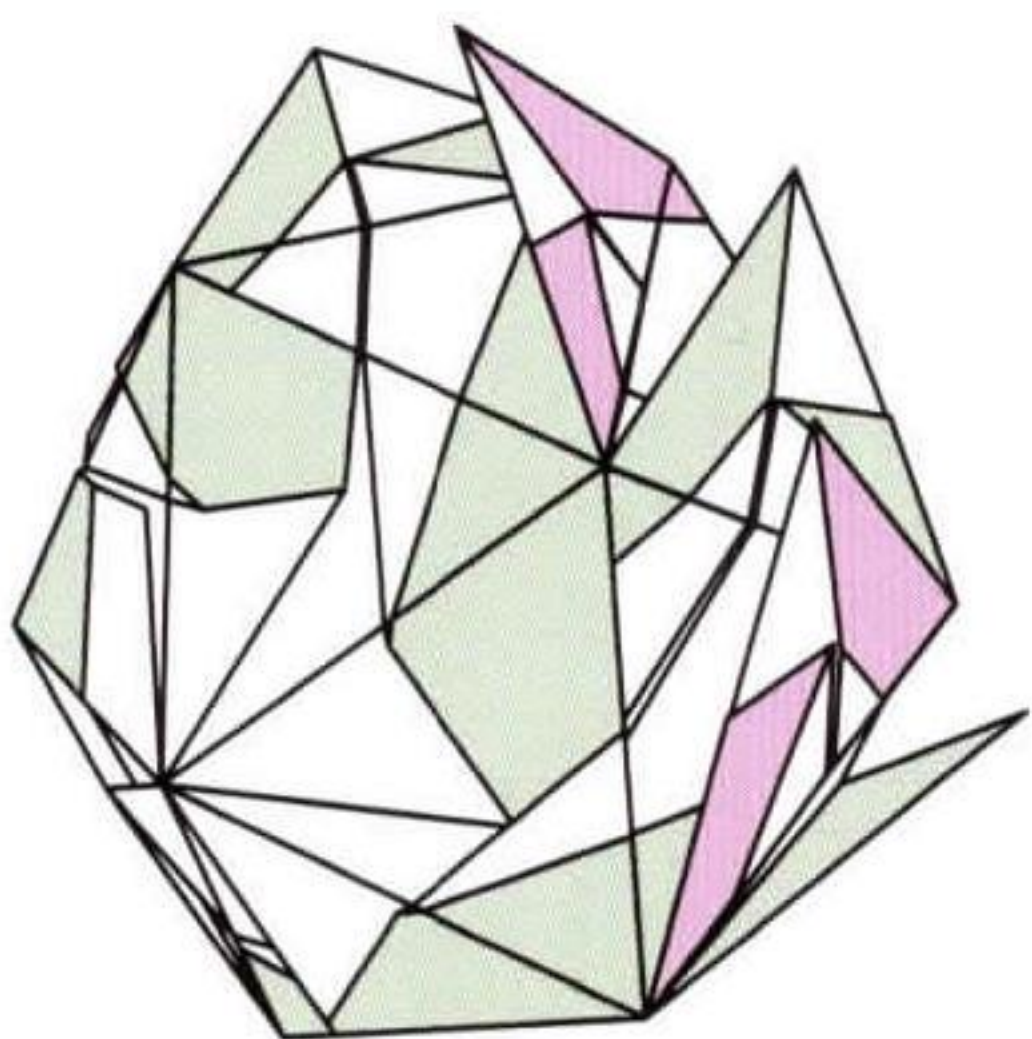

- 16 Now weave the two assemblies together. Flatten the equilateral triangles from one assembly onto the matching triangles on the other.

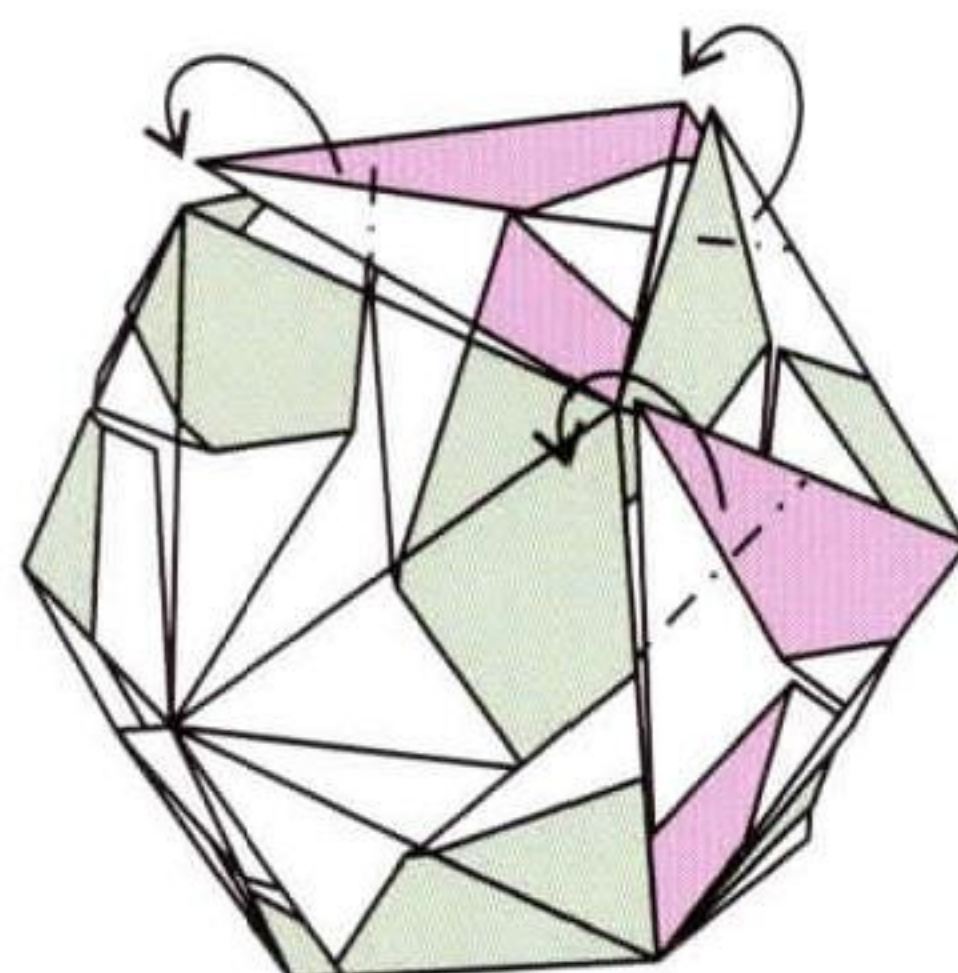

- 17 Fold the corners of the triangles behind and into the pockets formed by the folded edges beneath.

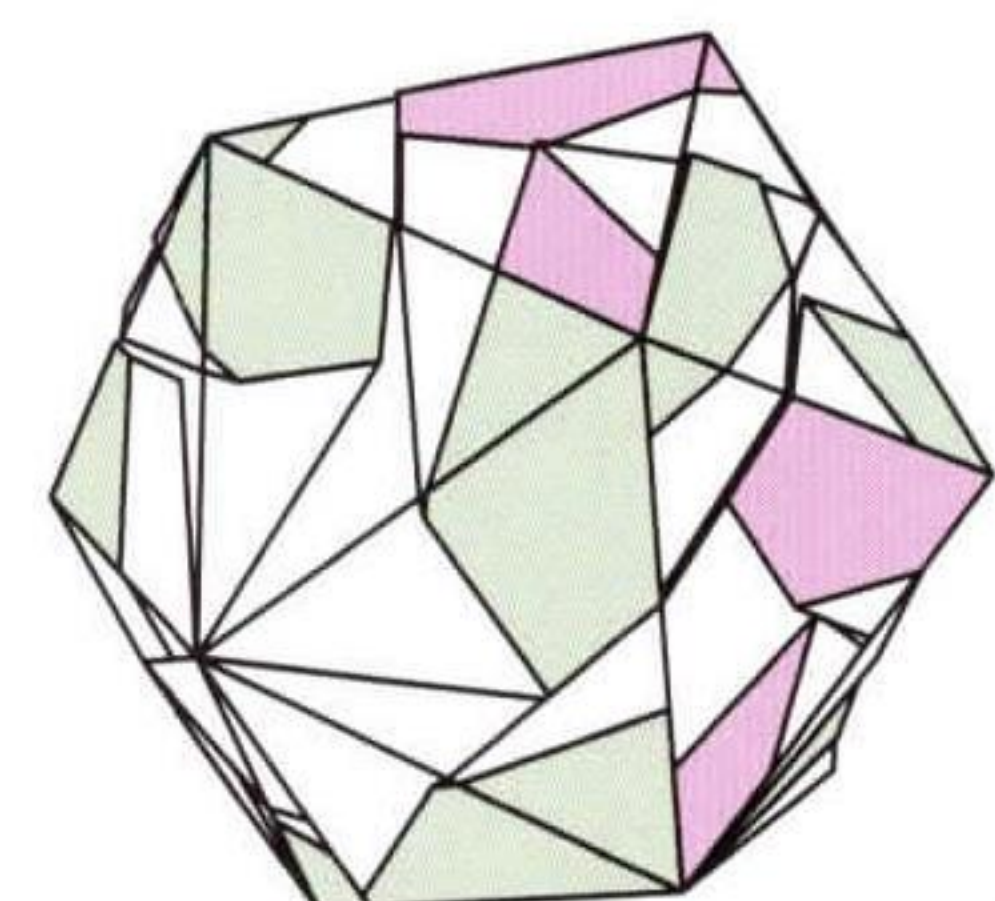

- 18 Icosahedron assembly complete. Alternative assemblies can be made from four and five units.

Harlequin Module

**

This is a module that can be used to make a series of shapes. The hexahedron is made from three units, although more regular shapes can be made from 1, 2, 3, 6, 12 and 30 units.

8 X 18CM (7 X 7IN)

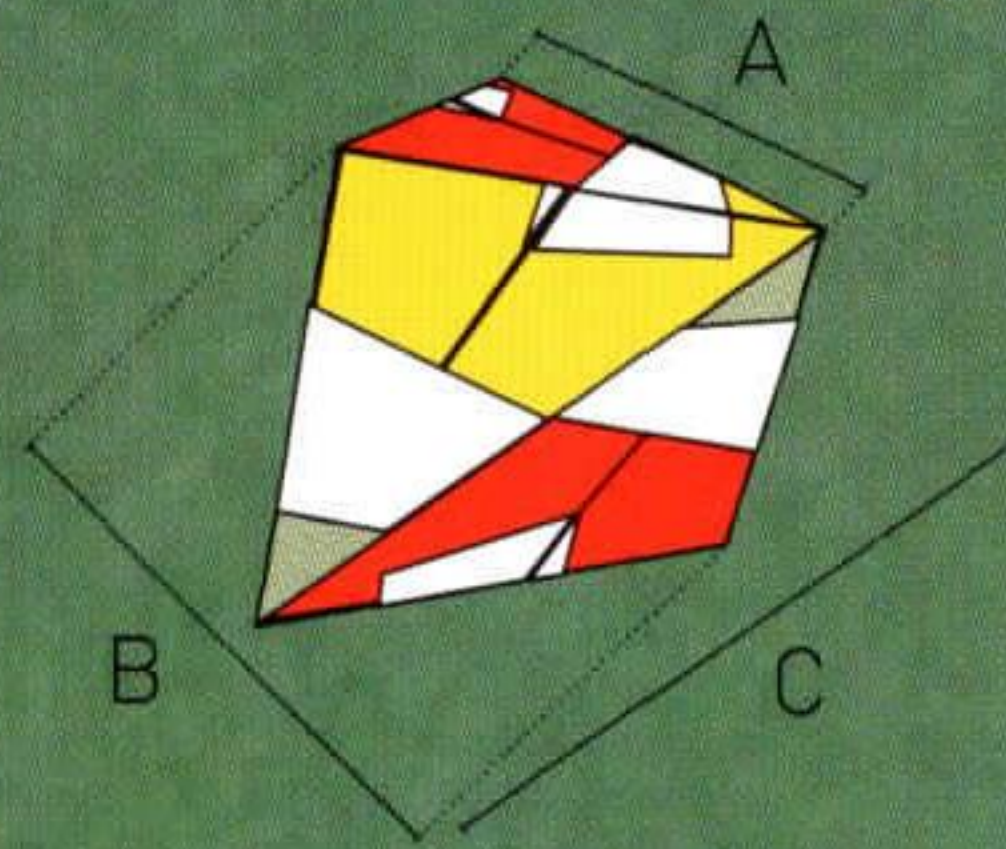
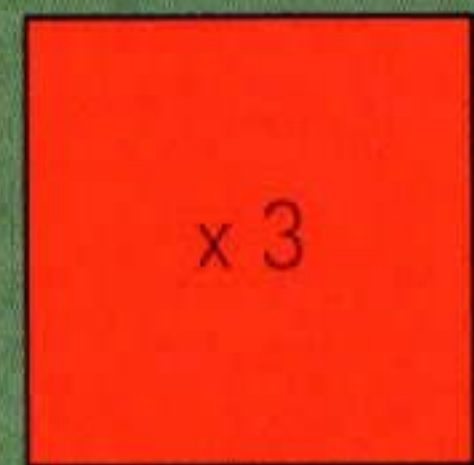

A 12cm (4 $\frac{2}{3}$ in)
B 9.75cm (4in)
C 12cm (4 $\frac{2}{3}$ in)

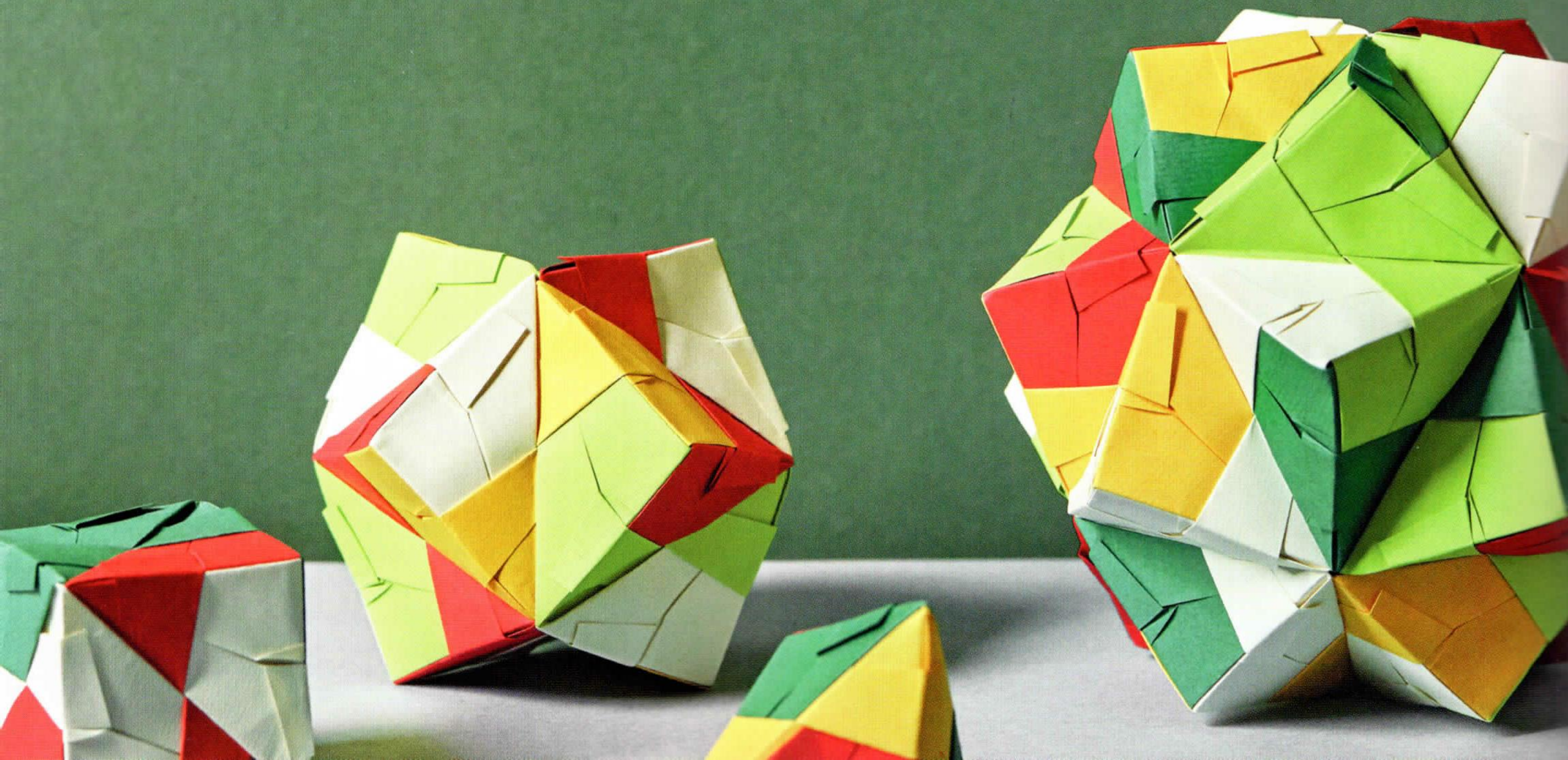

THE HEXAHEDRON IS MADE FROM THREE UNITS. FOR EACH UNIT START WITH A SQUARE, COLOURED SIDE DOWN.

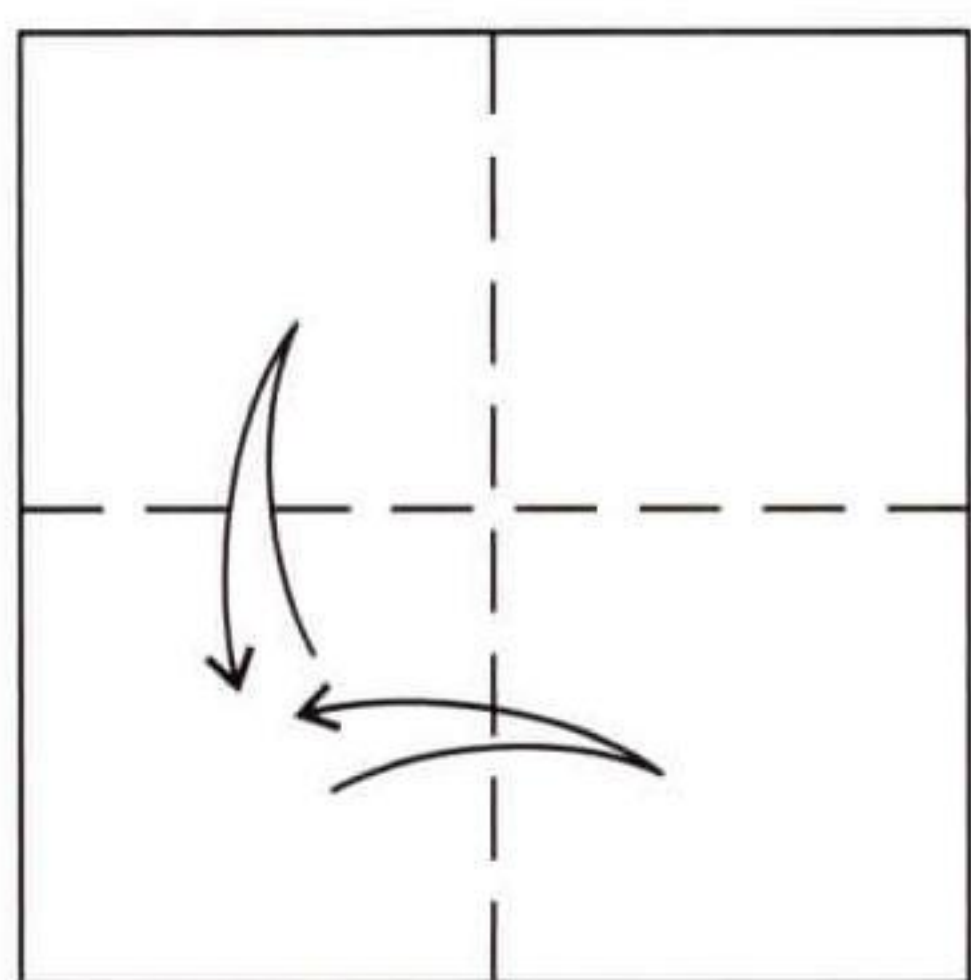

1 Fold and unfold the square in half lengthwise along both axes.

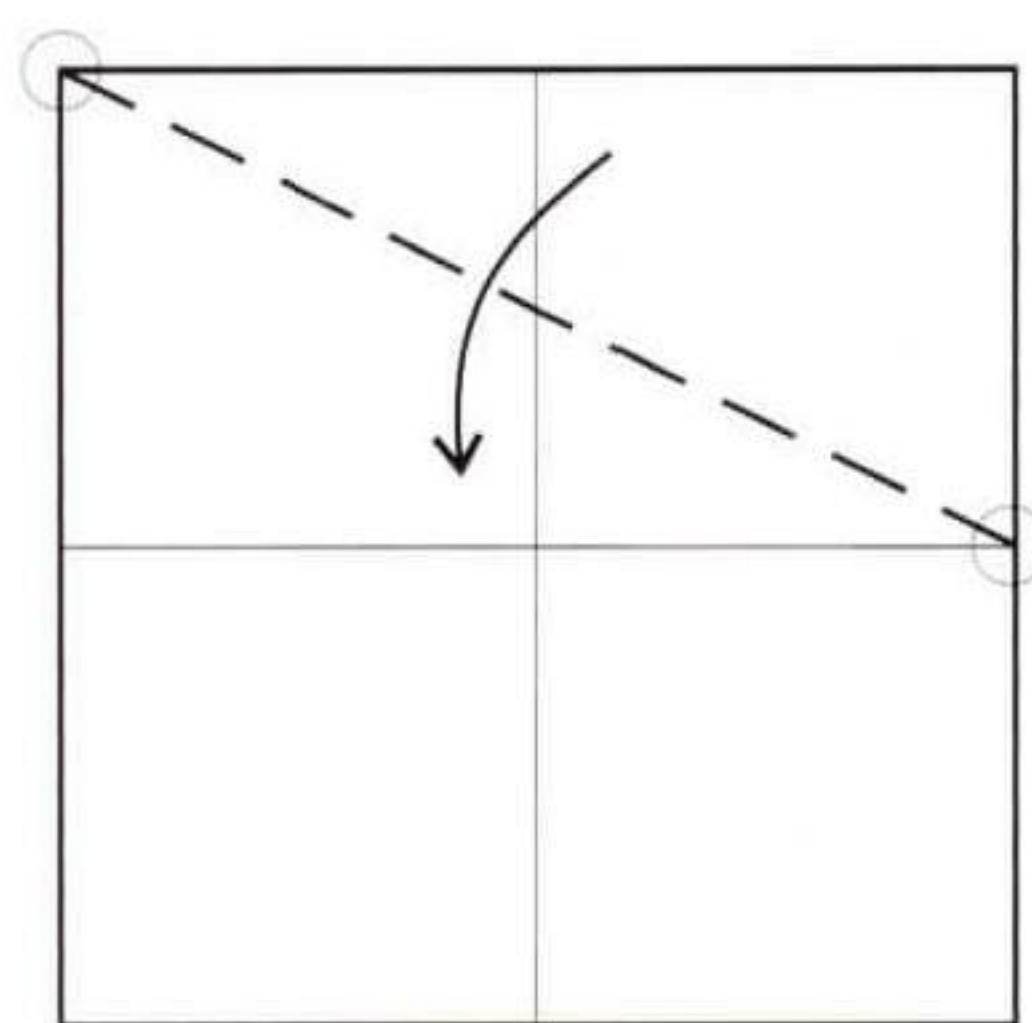

2 Fold the upper corner down between the upper corner and the crease made previously.

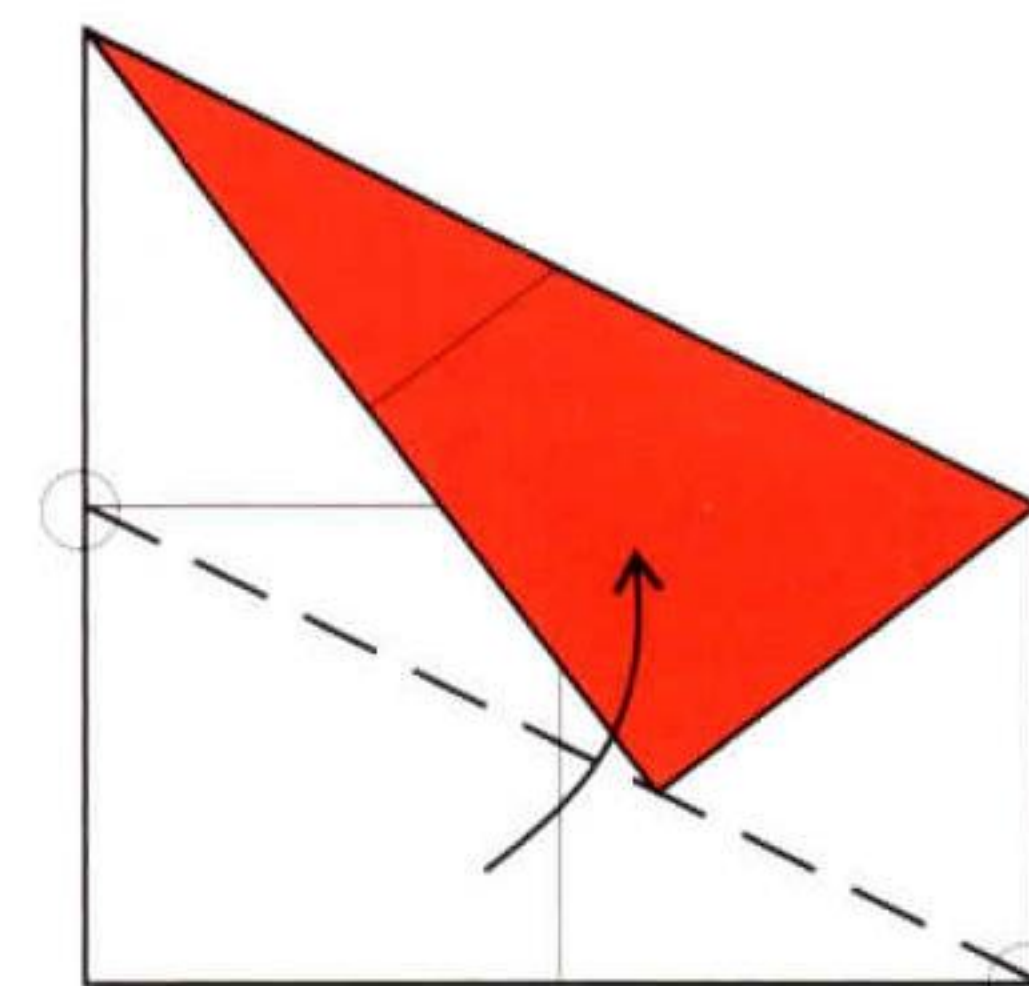

3 Fold the lower corner up between the corner and the crease.

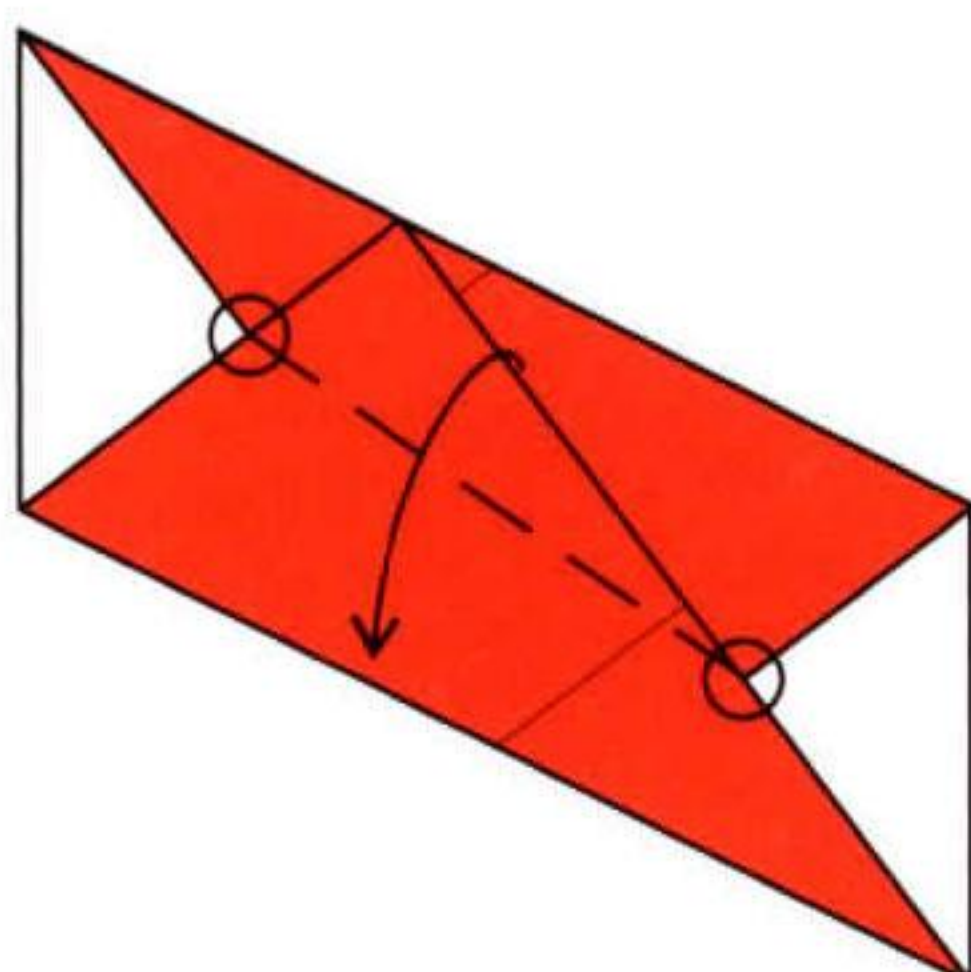

4 Fold the middle section down where the folded layers touch.

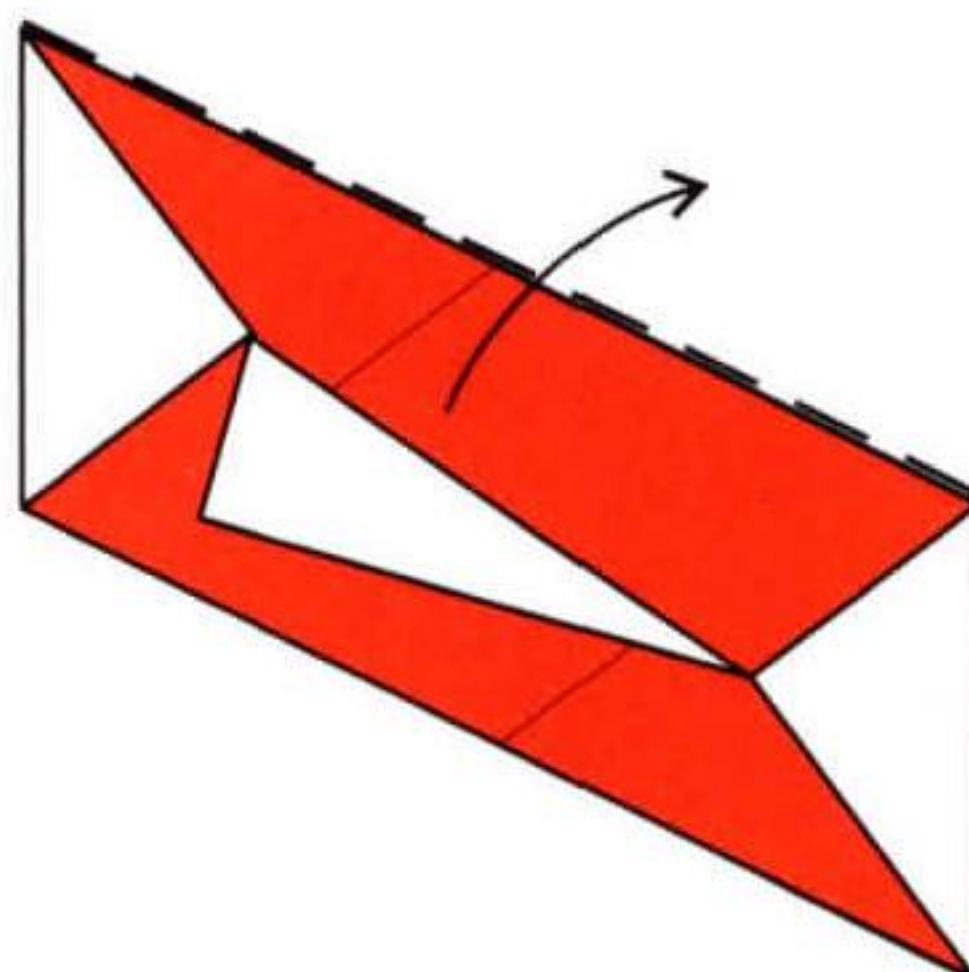

5 Fold the upper corner back out again.

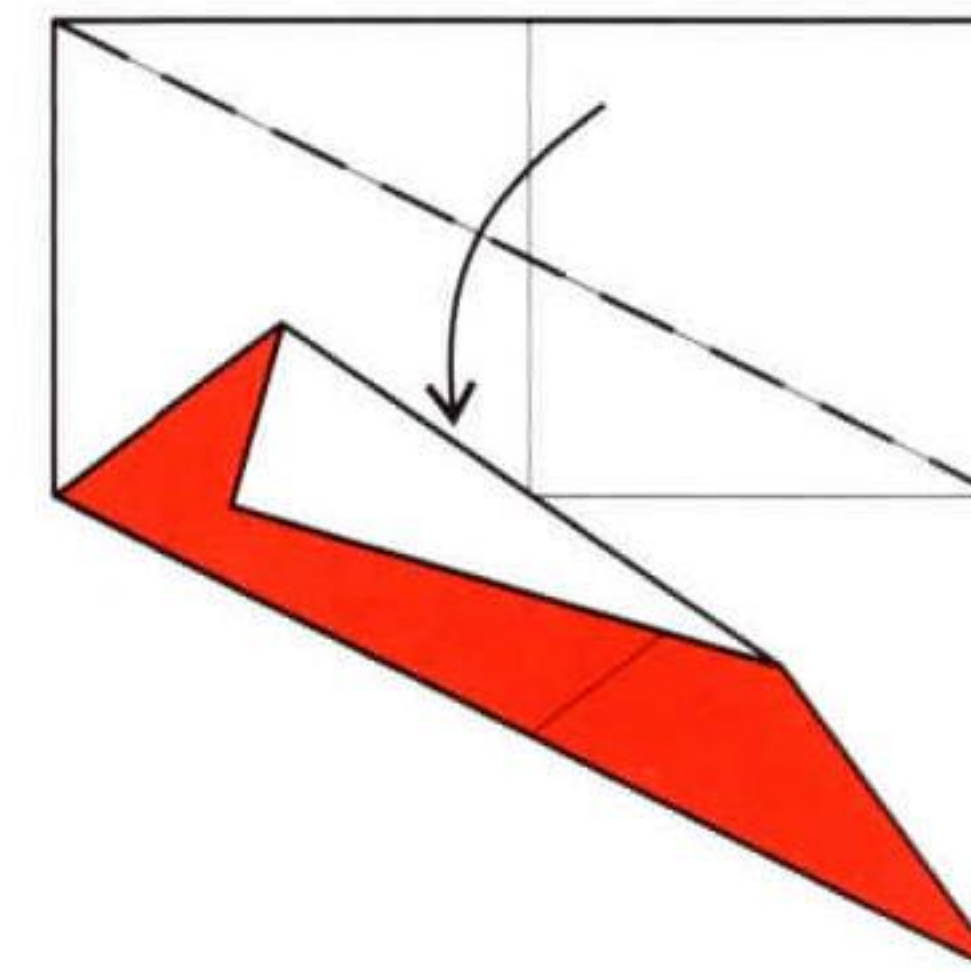

6 Fold the corner back down again, along the crease made previously.

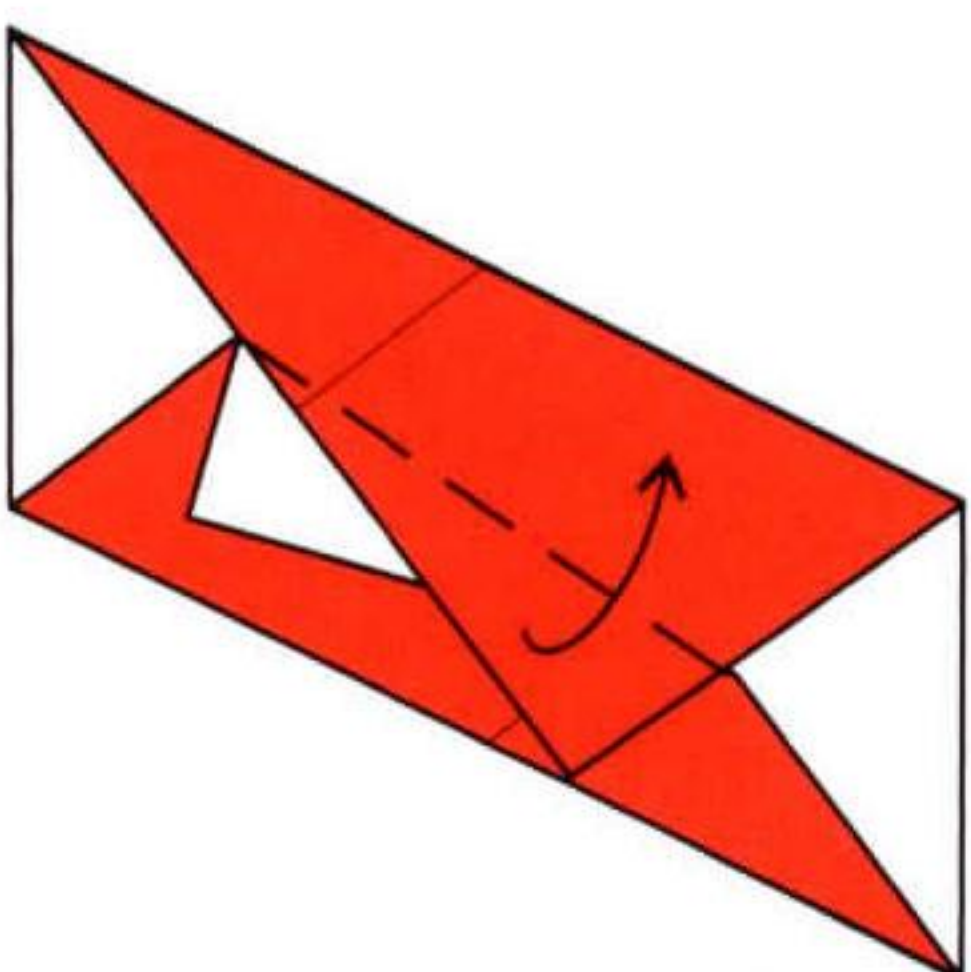

7 Fold the corner up along the folded edge beneath.

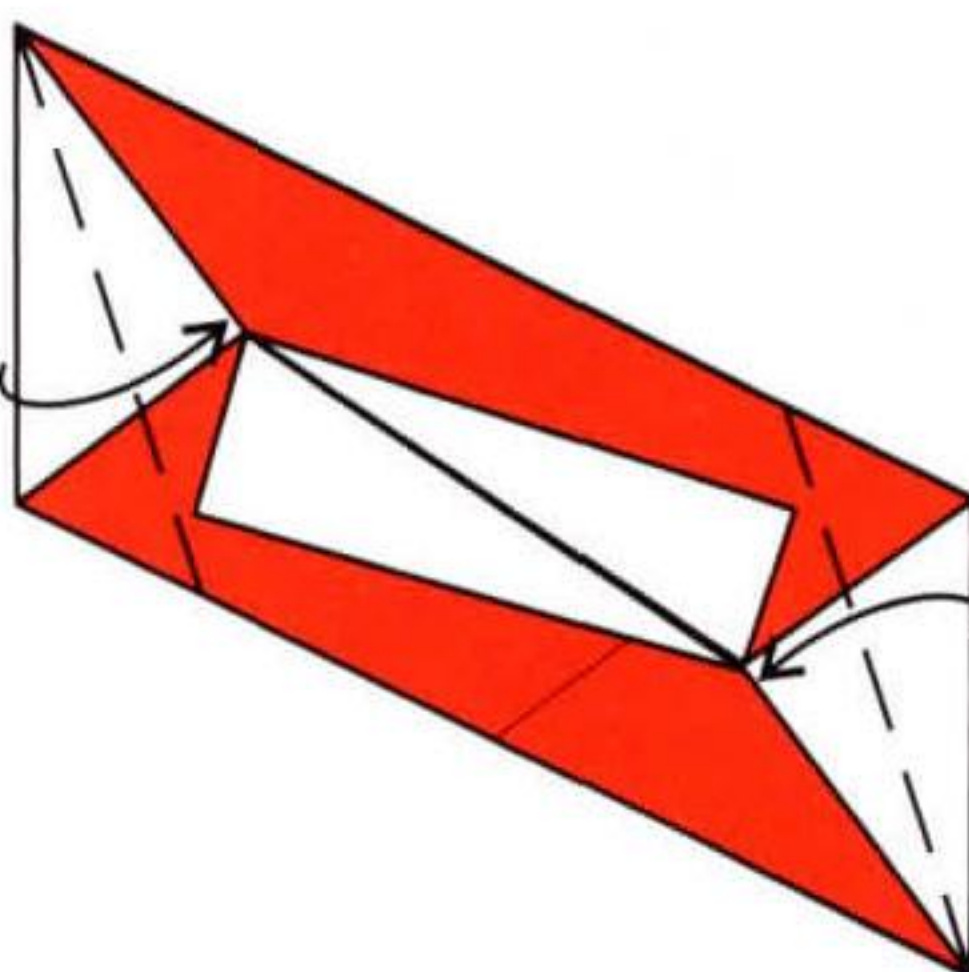

8 Fold the outer edges in on both sides.

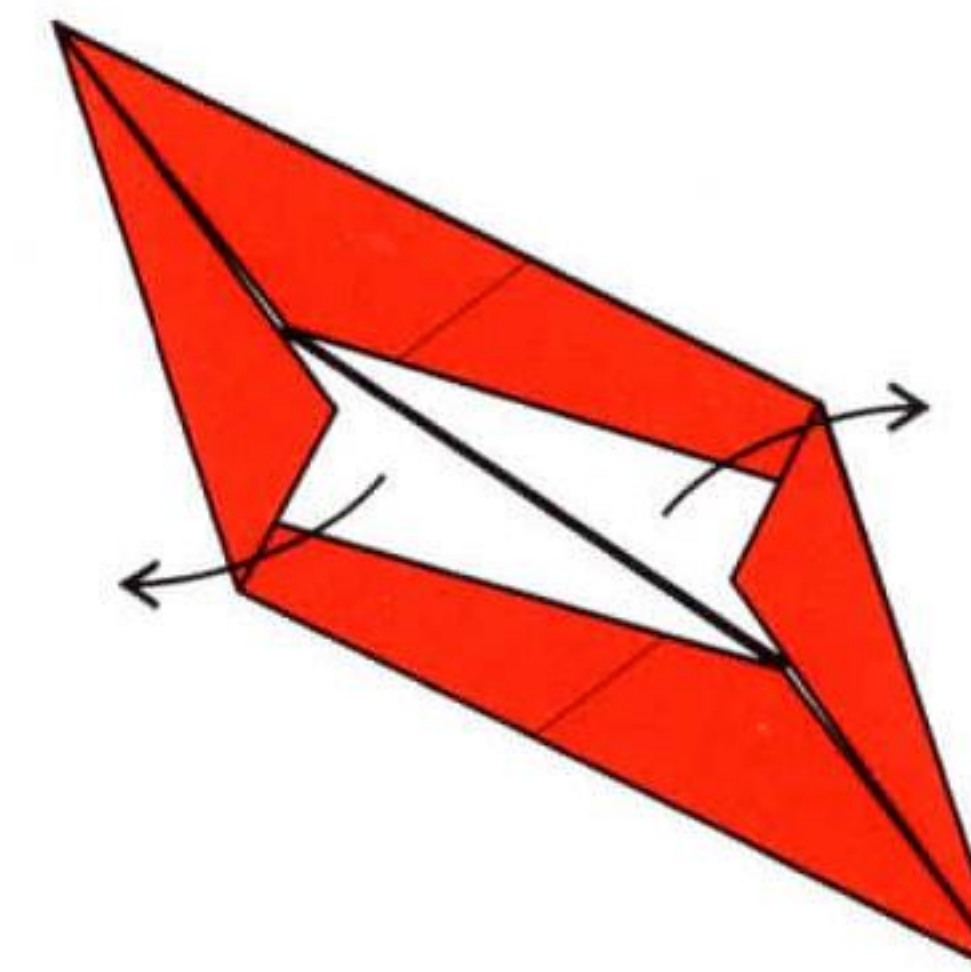

9 Lift up the inner white section and bring them on top of the folded outer corners.

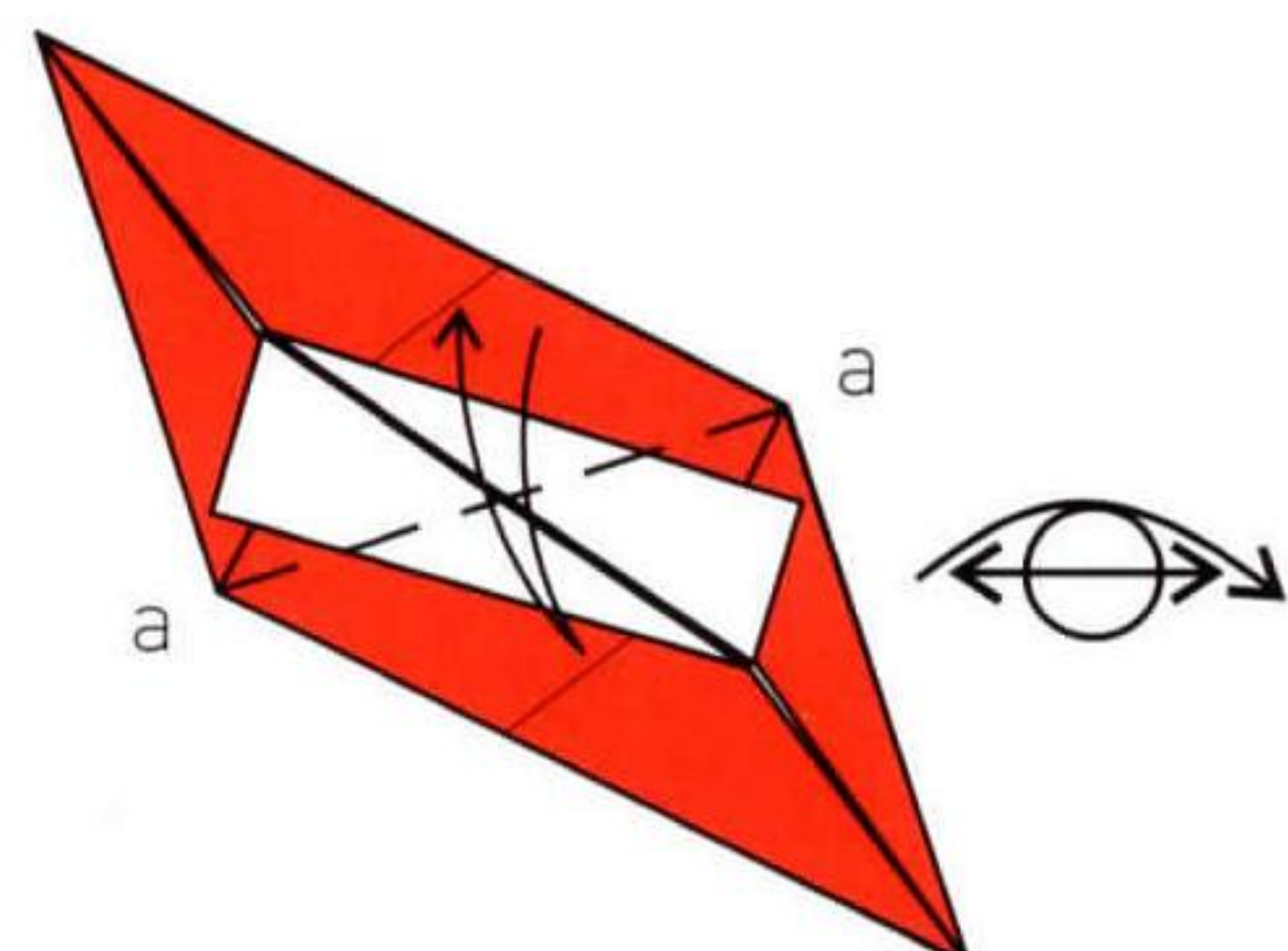

10 Fold the model in half along the axes (a-a). Then turn the model over left to right.

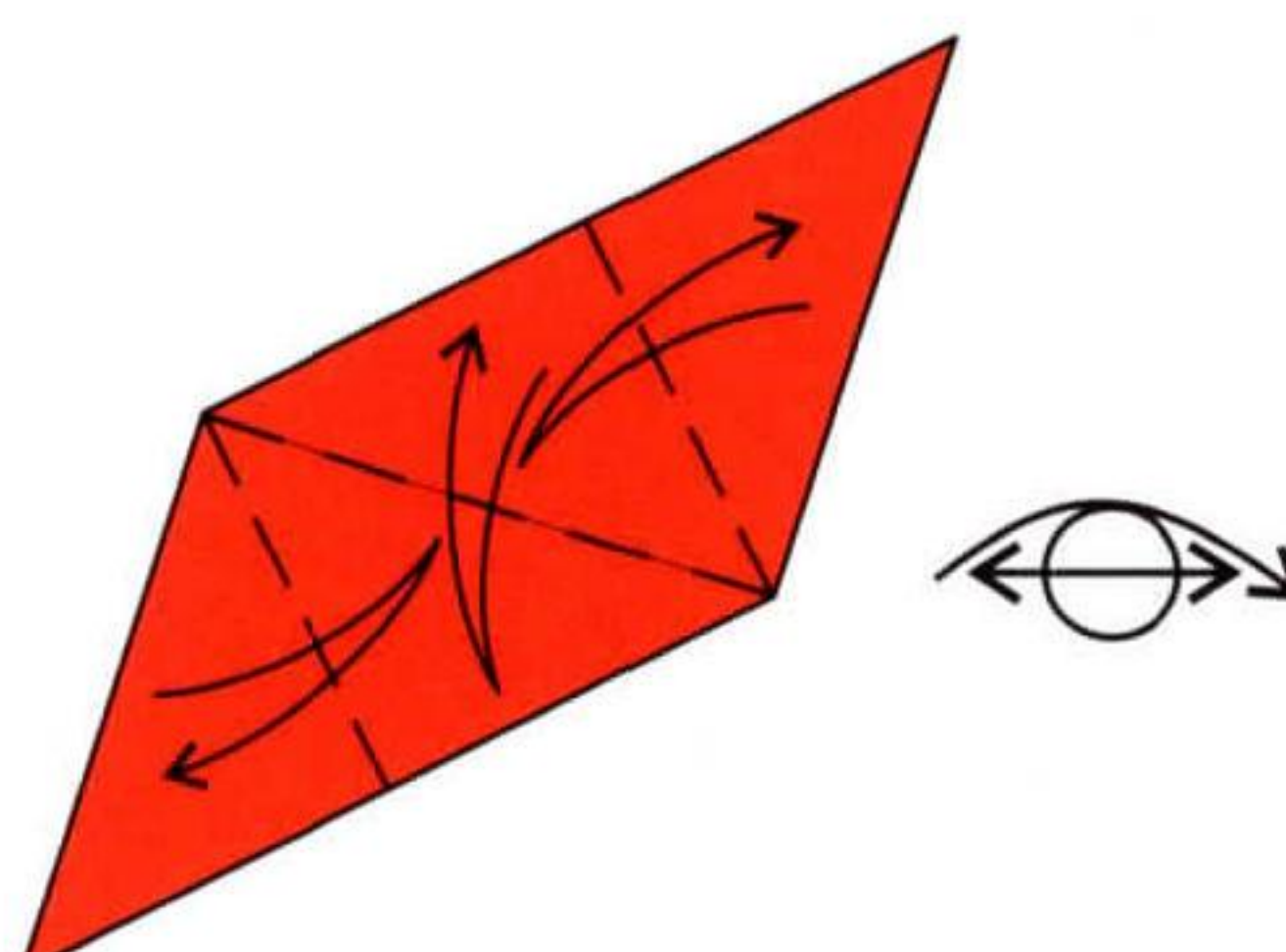

11 Fold the corners in and out again. Then turn the model over left to right.

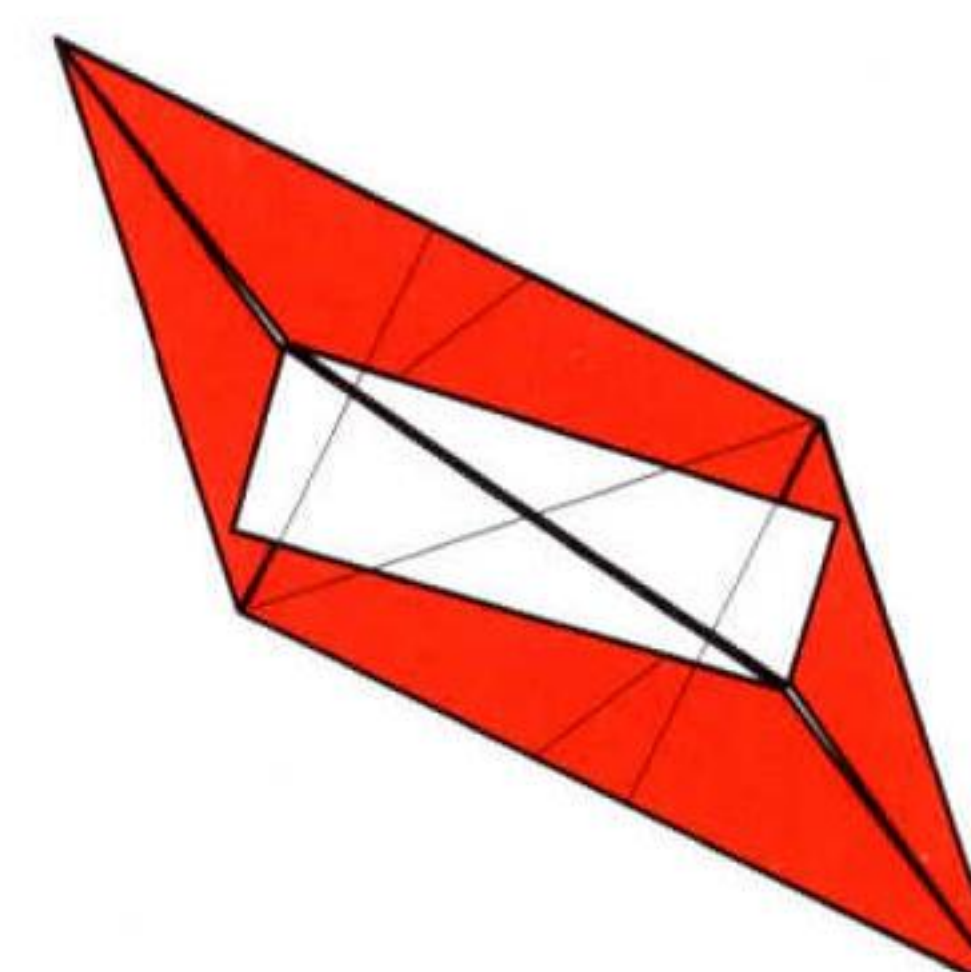

12 Module complete.

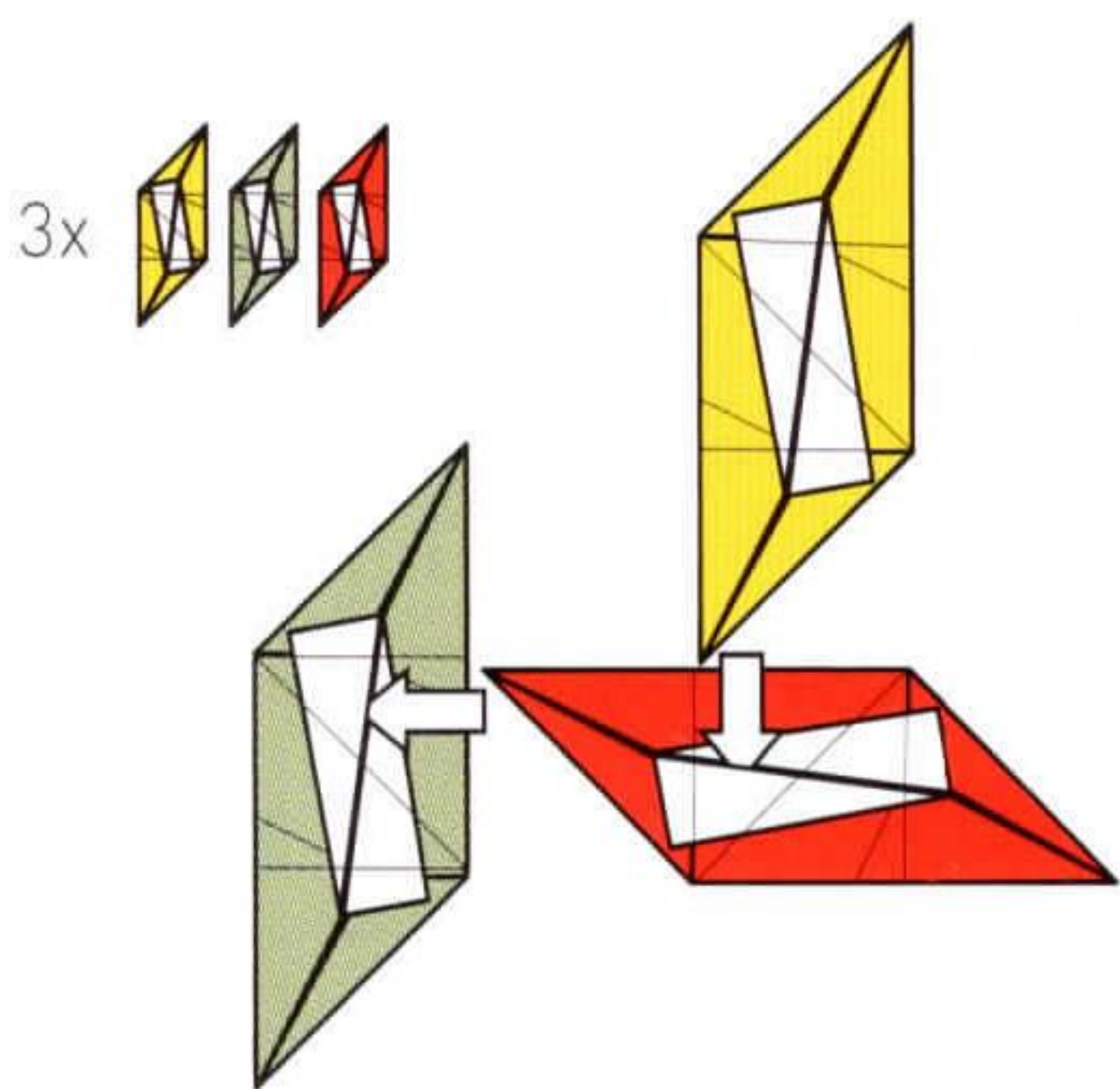

13 Three units can be assembled to make a hexahedron. Weave the modules together by inserting the corners into the pockets as indicated.

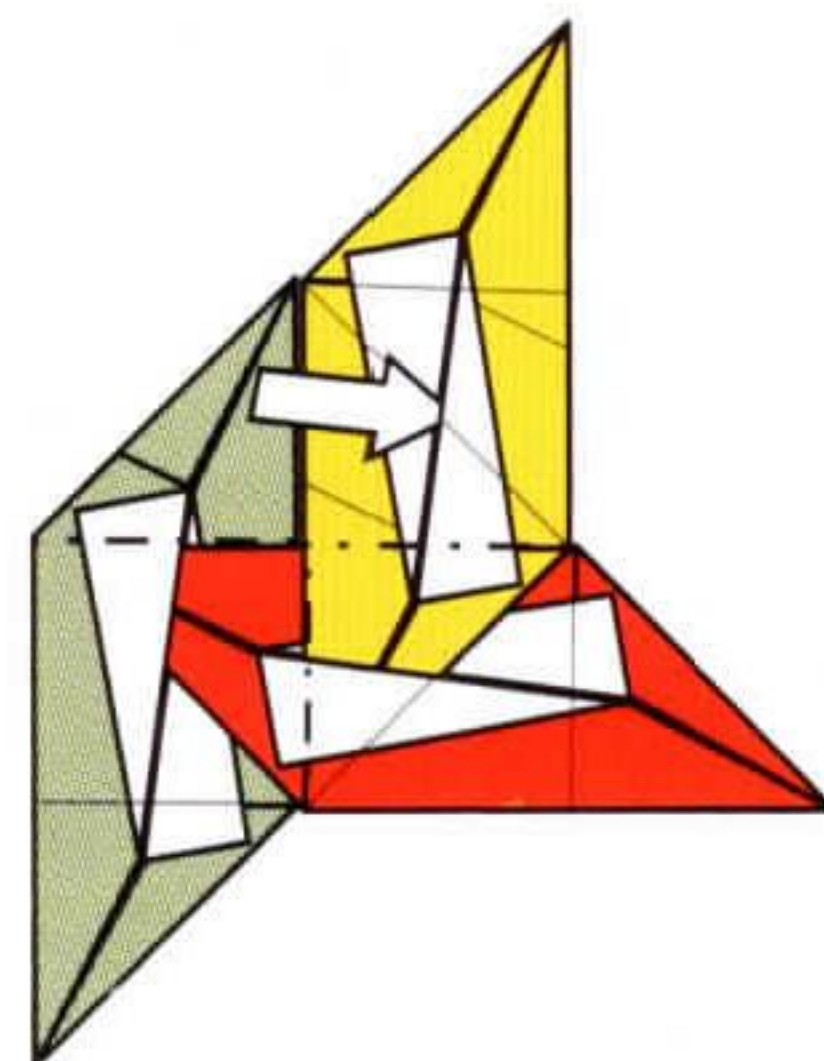

14 The final corner inserts into the pocket and the middle section becomes a triangular pyramid made from three connected isosceles triangles.

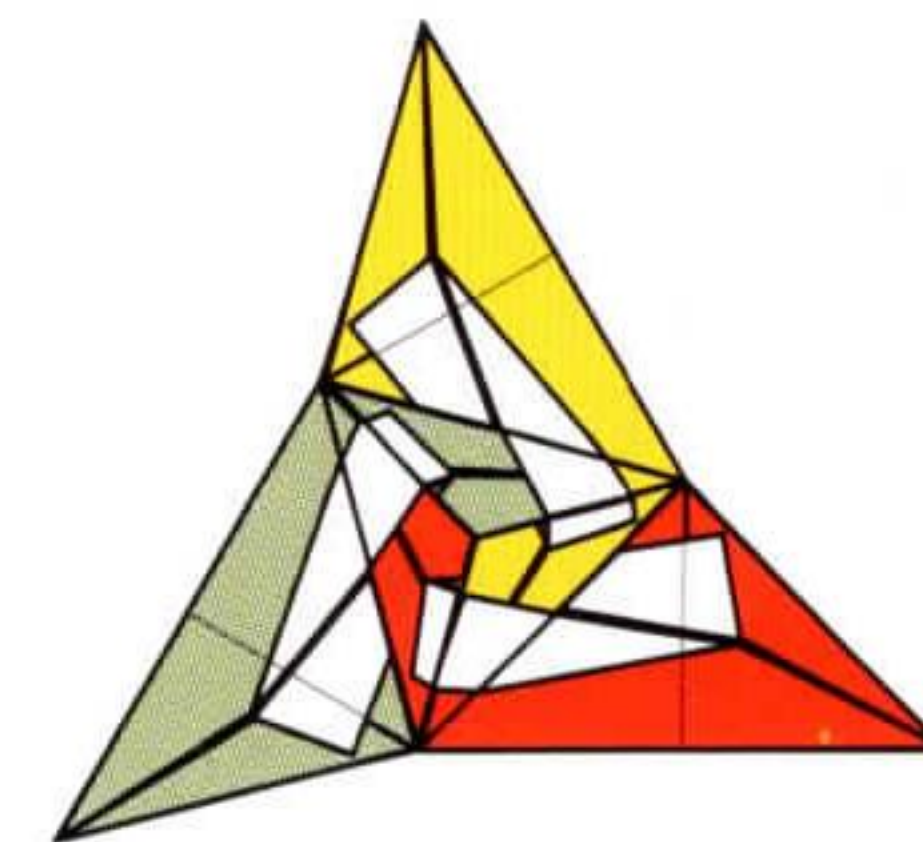

15 Turn the model over to look at the underside.

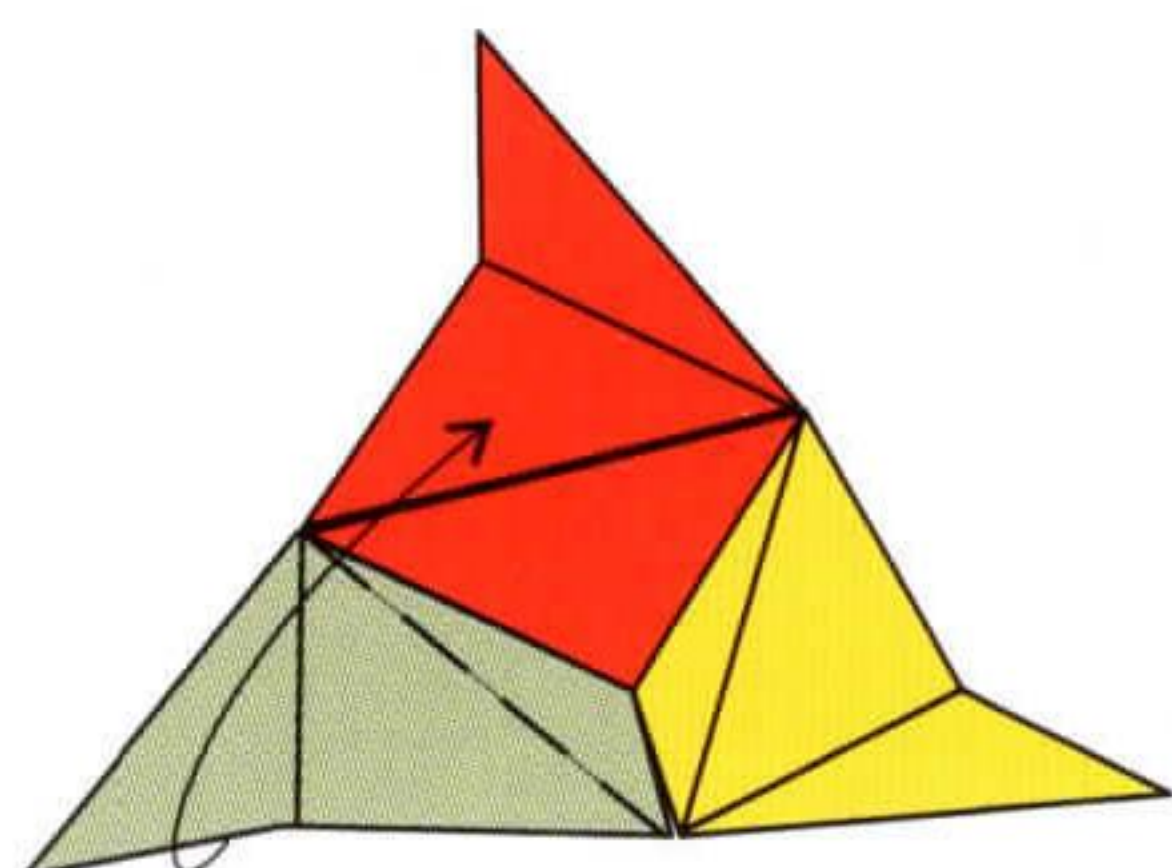

16 Fold one side in.

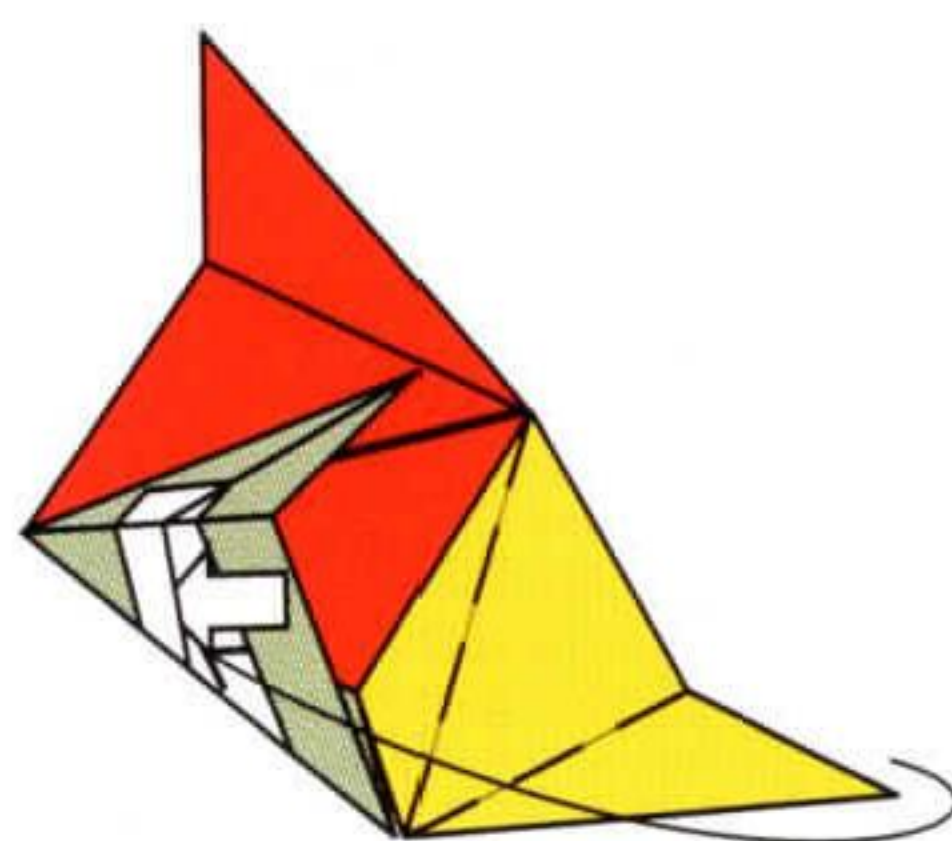

17 Fold the next section (yellow) up and tuck the corner into the adjacent pocket. Repeat this on the third section.

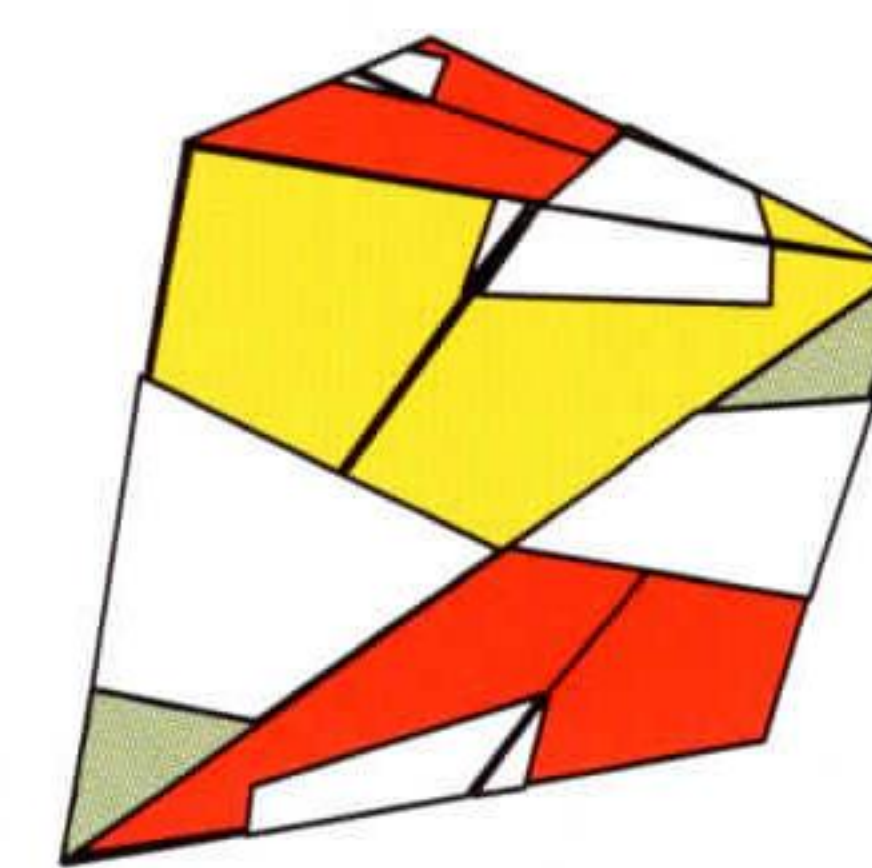

18 Hexahedron assembly complete.

MORE ASSEMBLIES



Three units

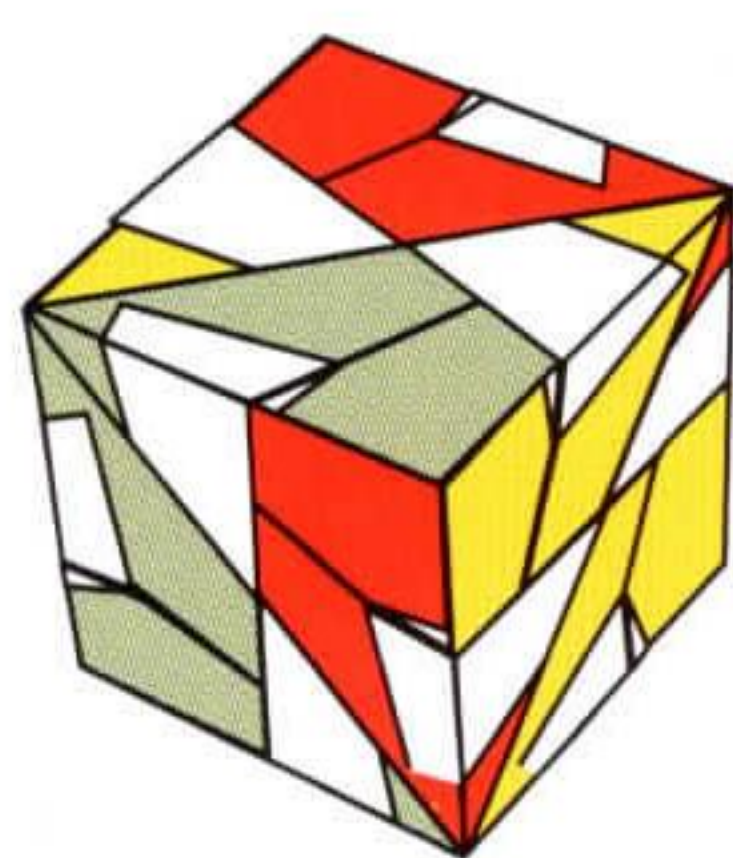

19 Six units can be assembled to make a cube.

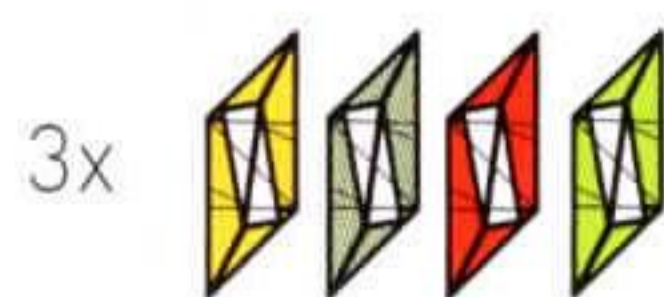

Four units

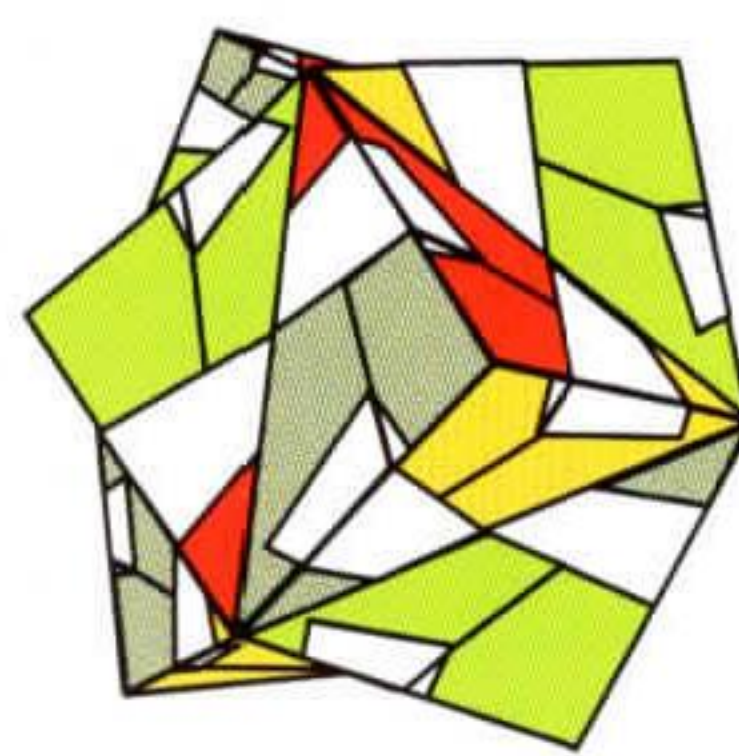

20 Twelve units will make a stellated octahedron.

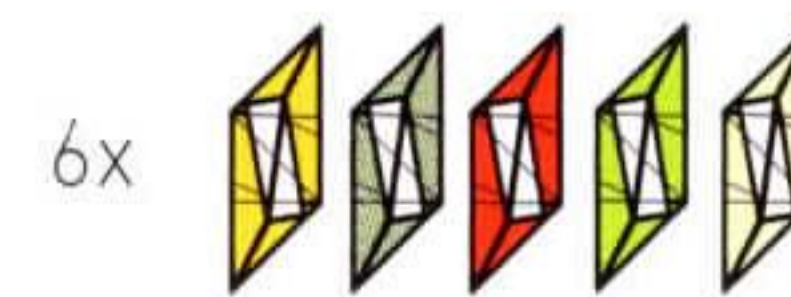

Five units

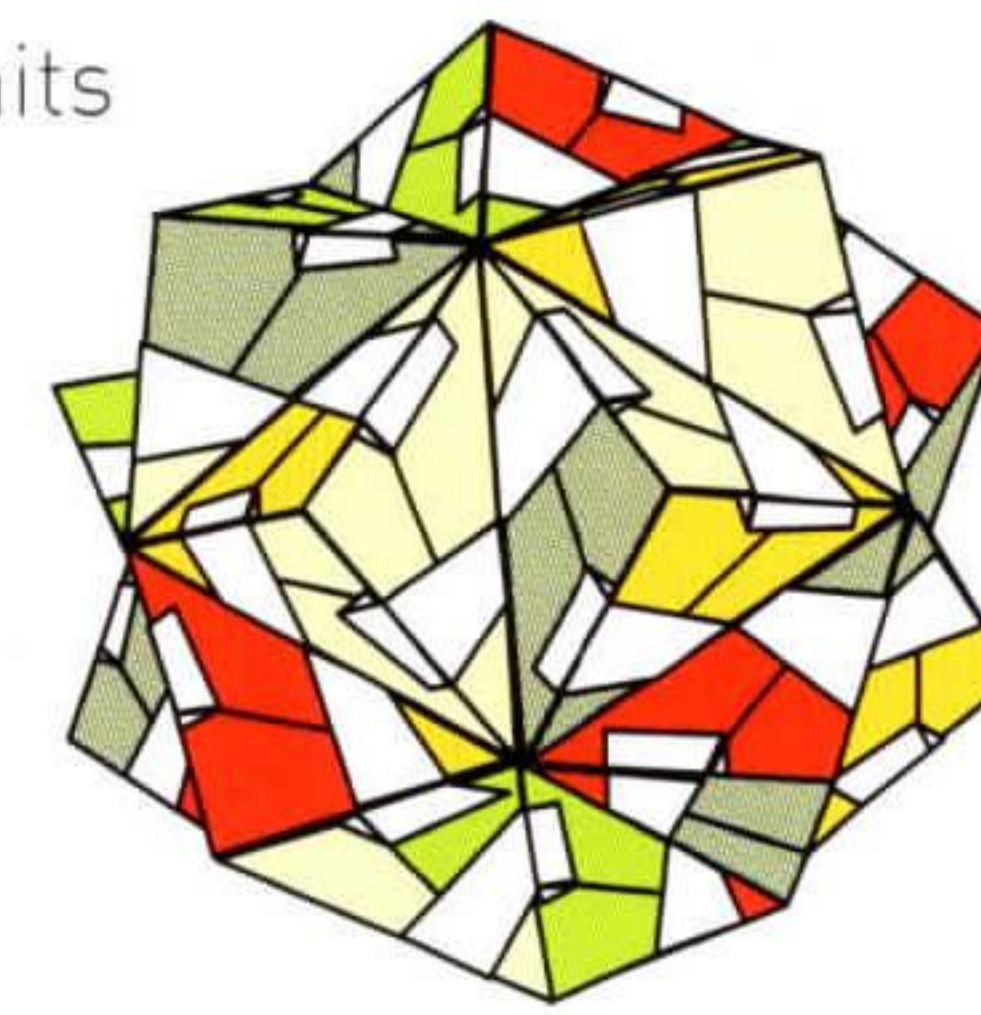

21 Thirty units can be assembled to make a stellated icosahedron.

Flower Ball

**

The flower ball unit can be assembled in a similar way to the previous project. The unit is made more intriguing by added folded layers that enhance its texture and overall look.

18 X 18CM (7 X 7IN)

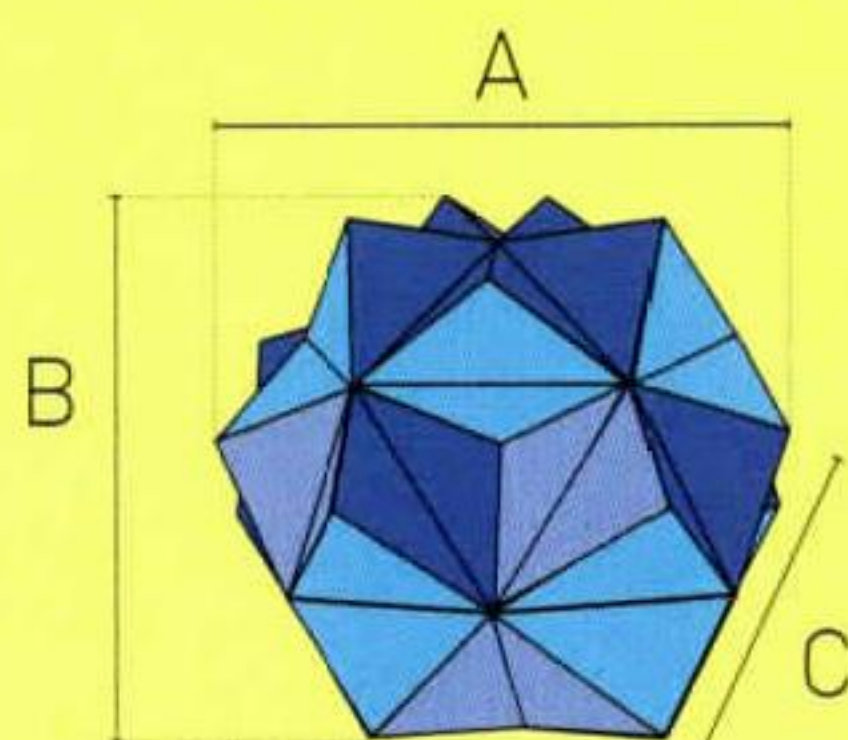
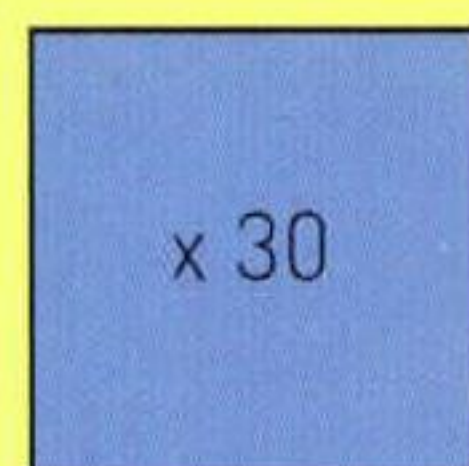

A 18cm (7in)
B 18cm (7in)
C 18cm (7in)

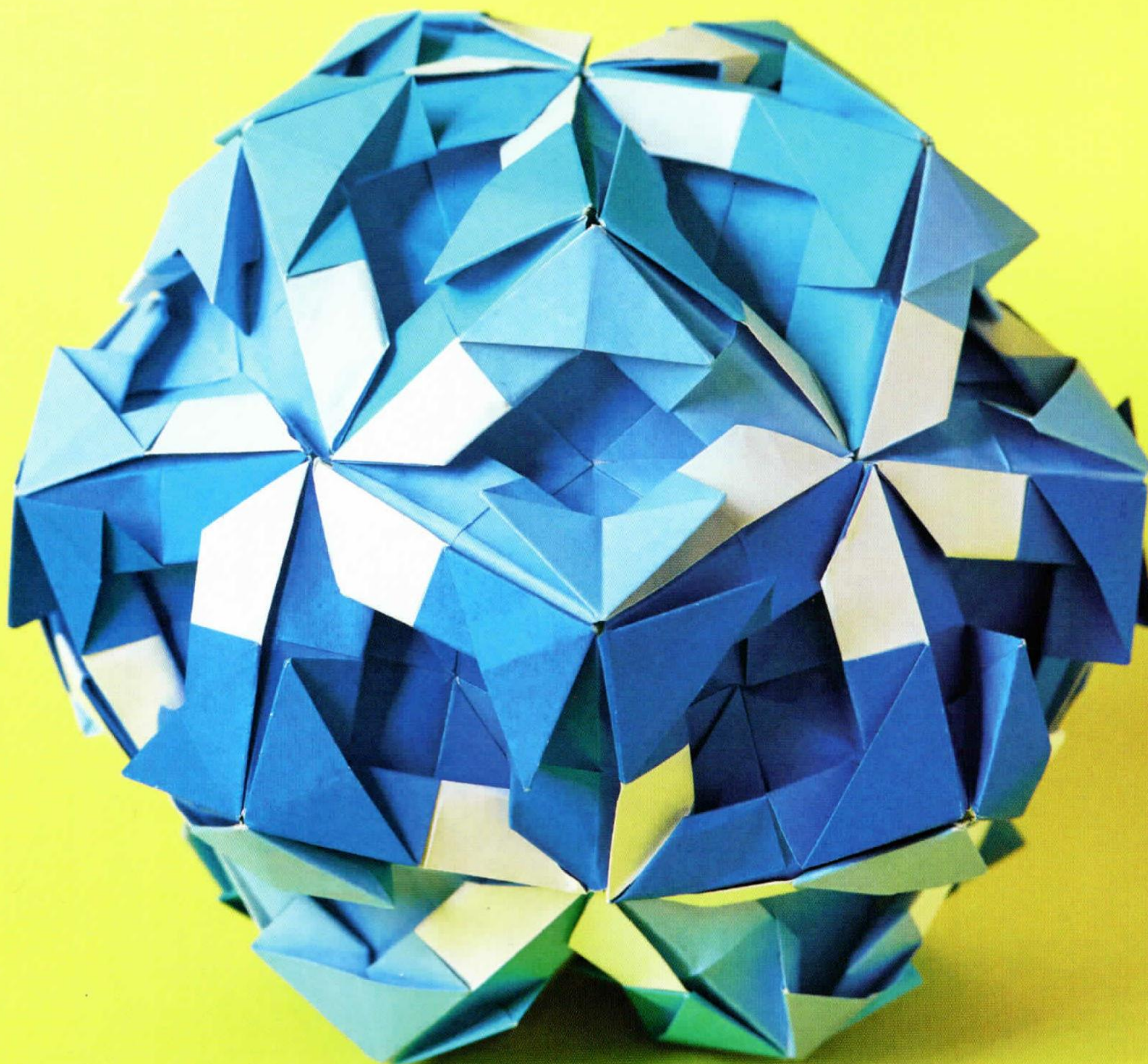

THE MODEL IS MADE FROM 30 UNITS. FOR EACH UNIT START WITH A SQUARE, COLOURED SIDE DOWN.

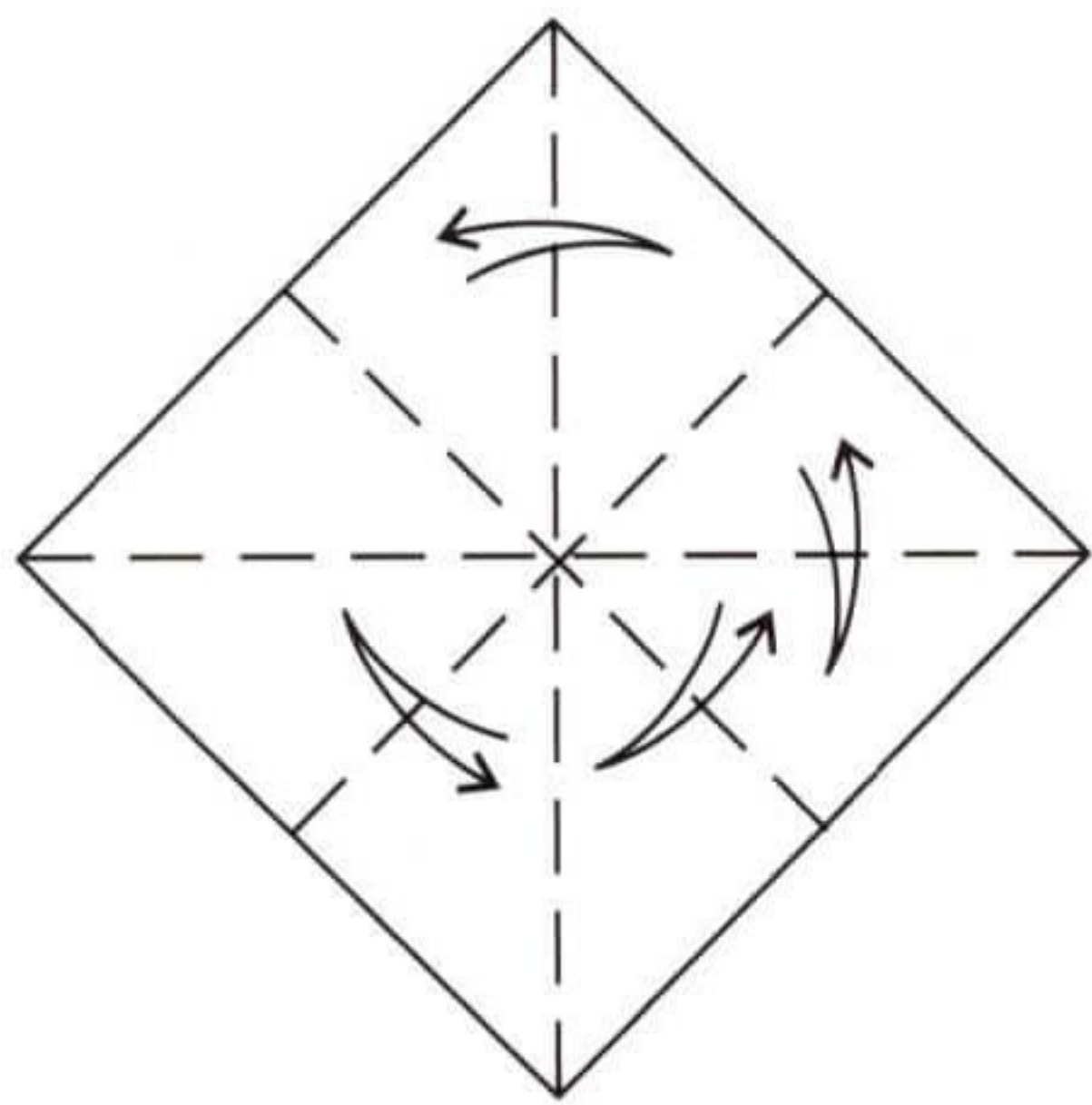

1 Fold and unfold the square in half lengthwise and diagonally along all axes.

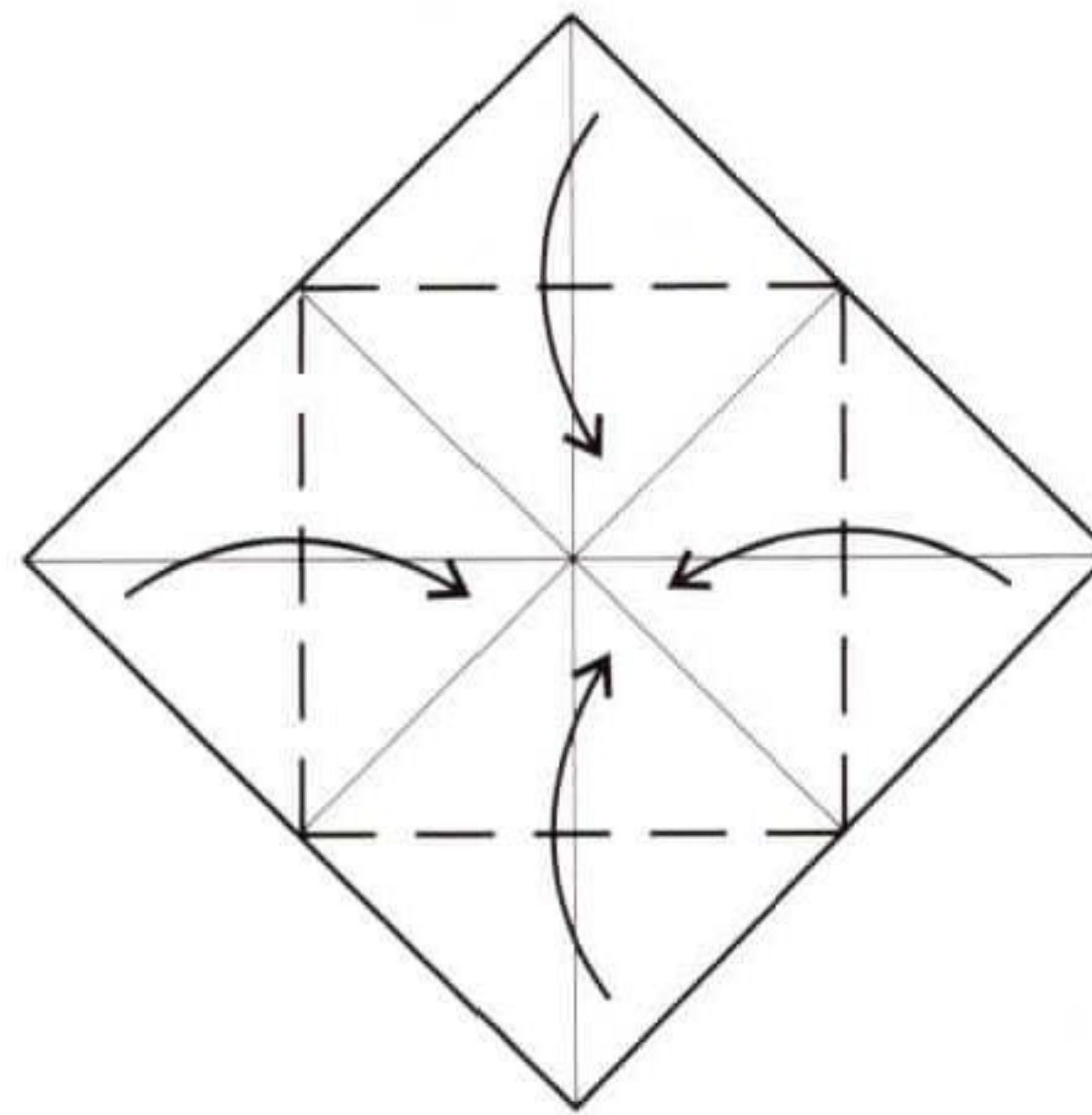

2 Fold the corners in to the middle.

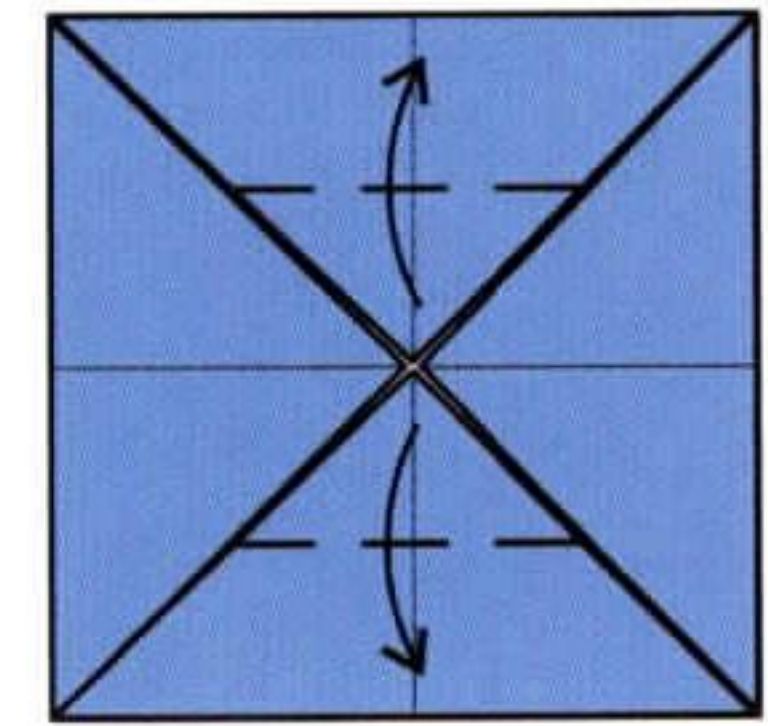

3 Fold the corners out to the folded edge.

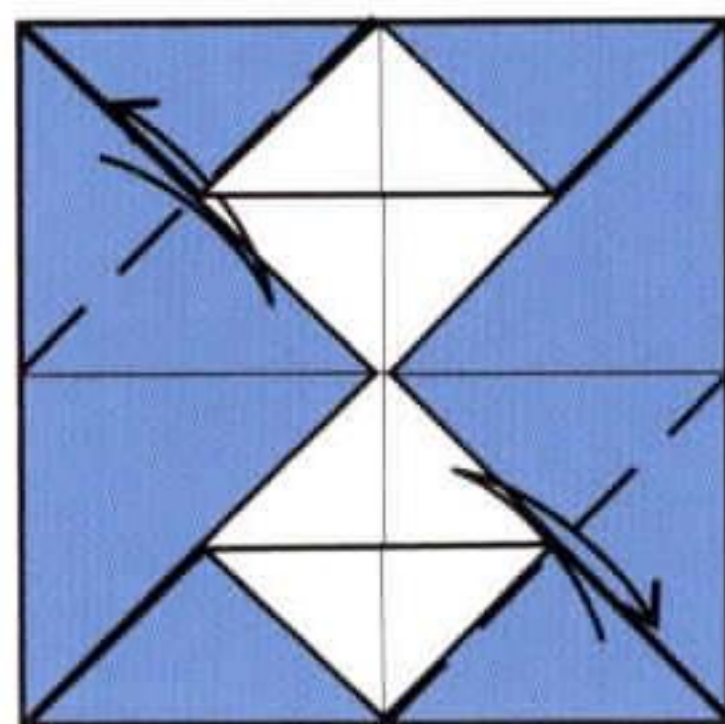

4 Fold and unfold opposing corners in to the middle.

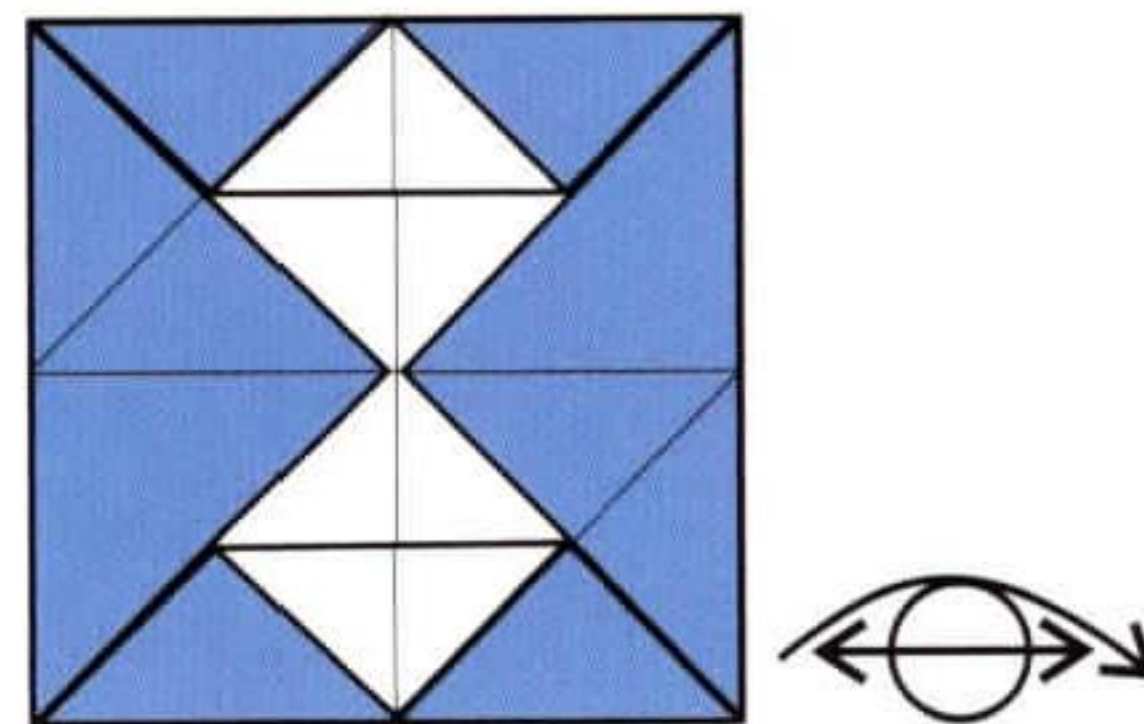

5 Turn the model over left to right.

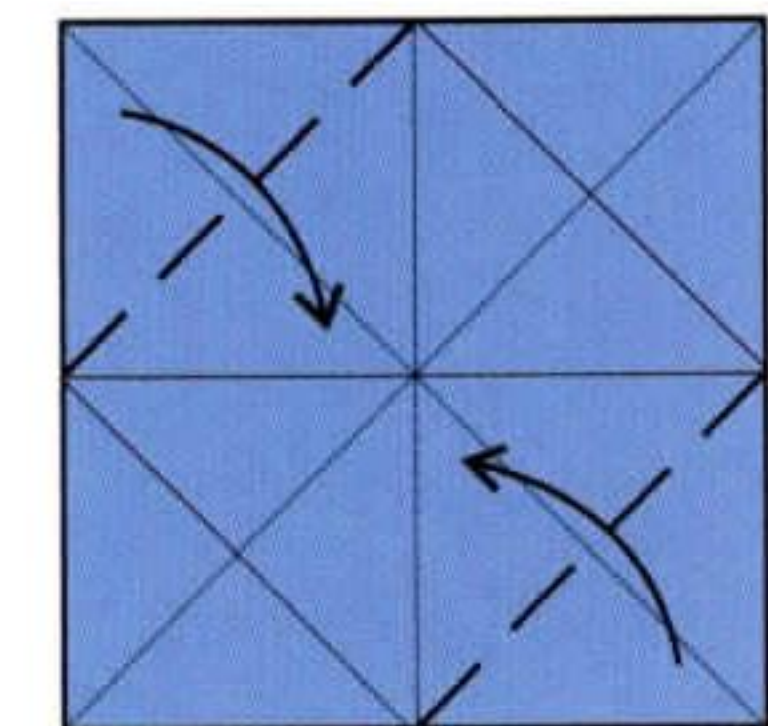

6 Fold the corners in to the middle.

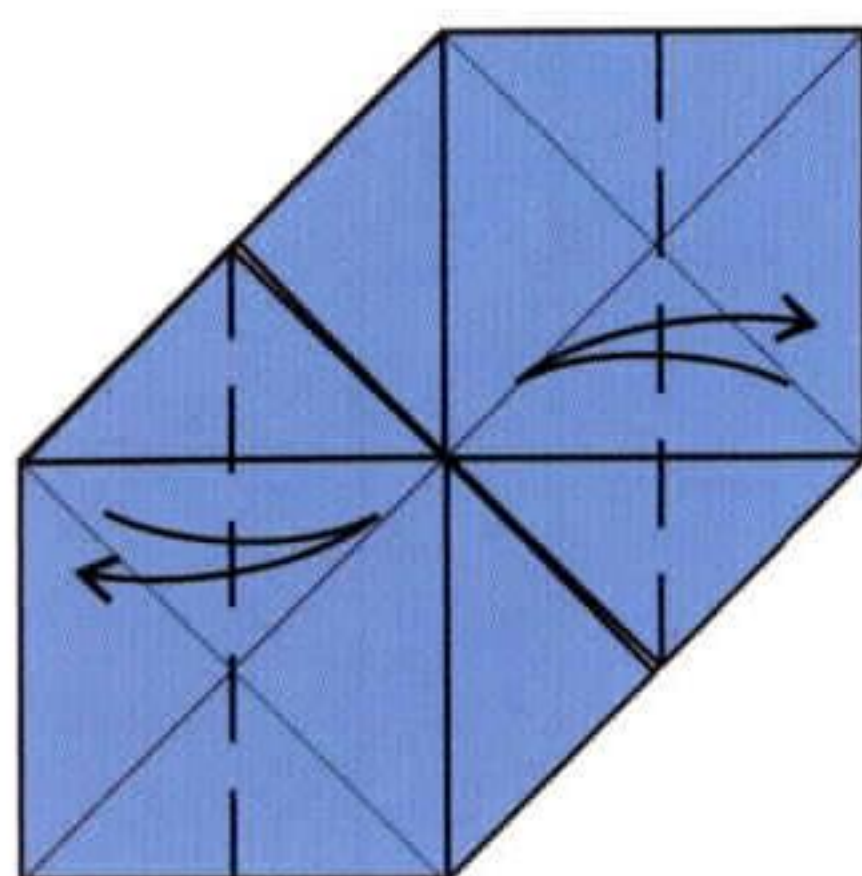

7 Fold and unfold the edges in to the middle crease.

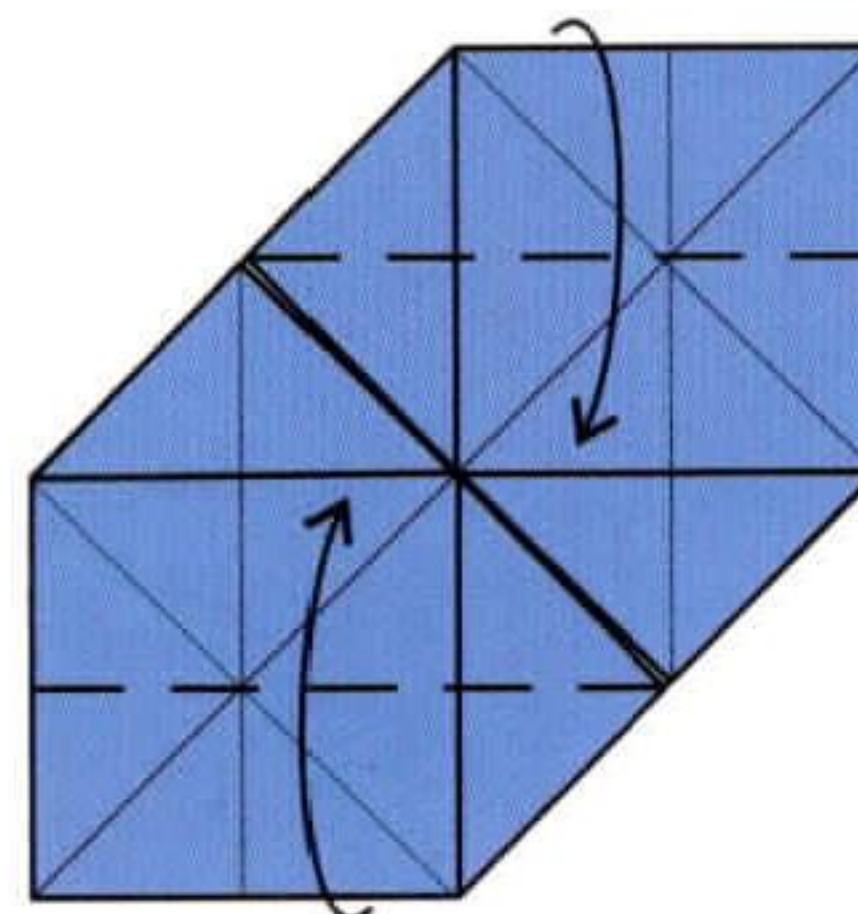

8 Fold the upper and lower edges in to the middle crease.

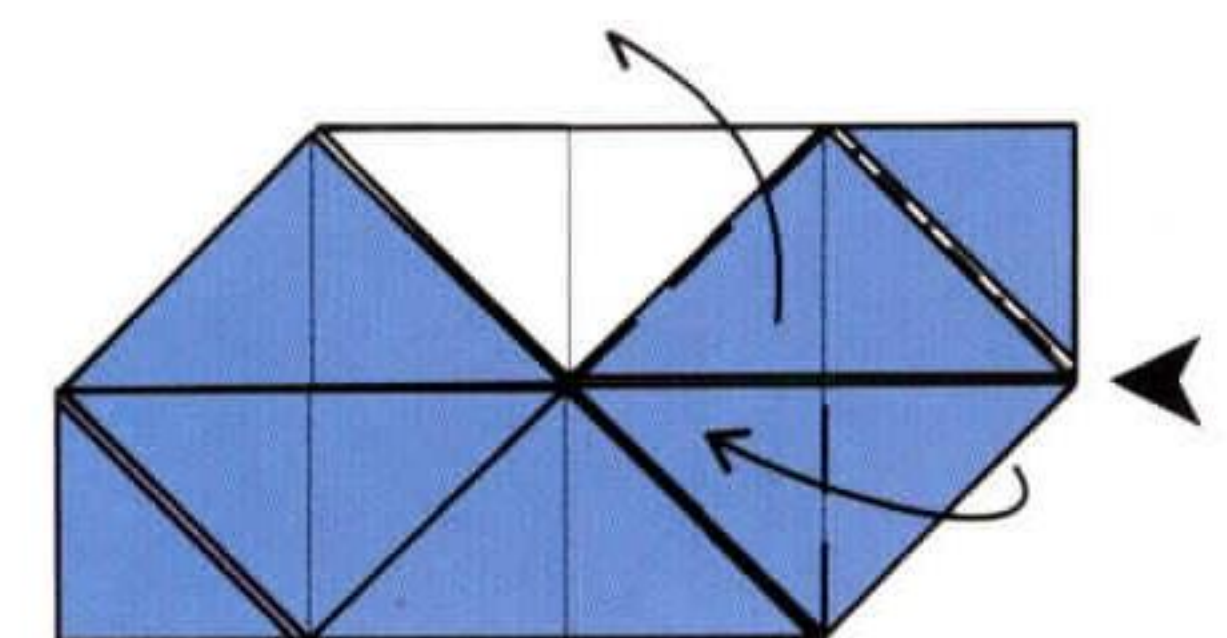

9 Fold the side in and fold up the lower edge to open up the section.

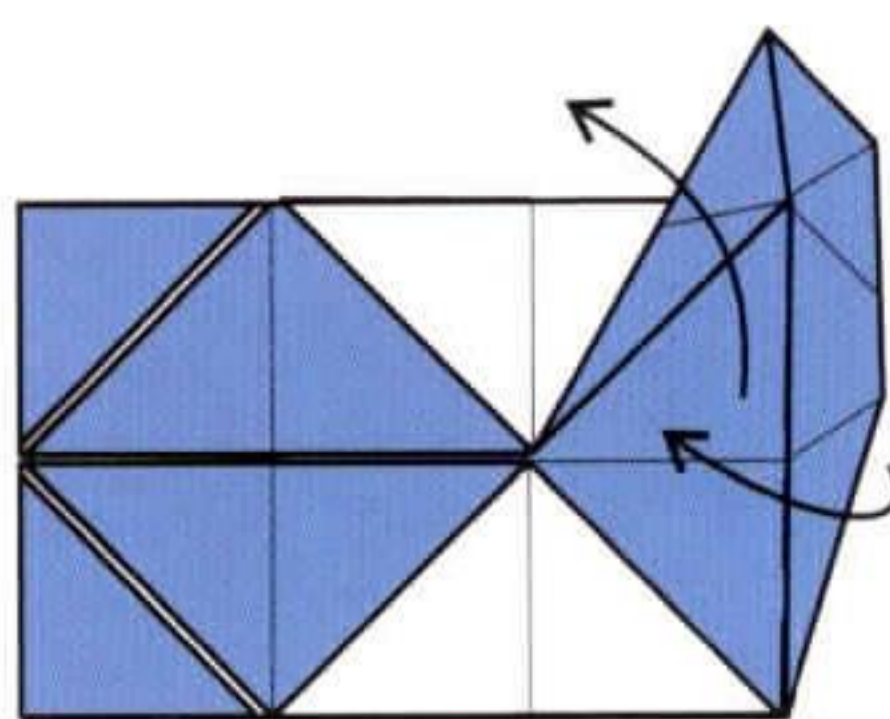

10 Fold in progress.

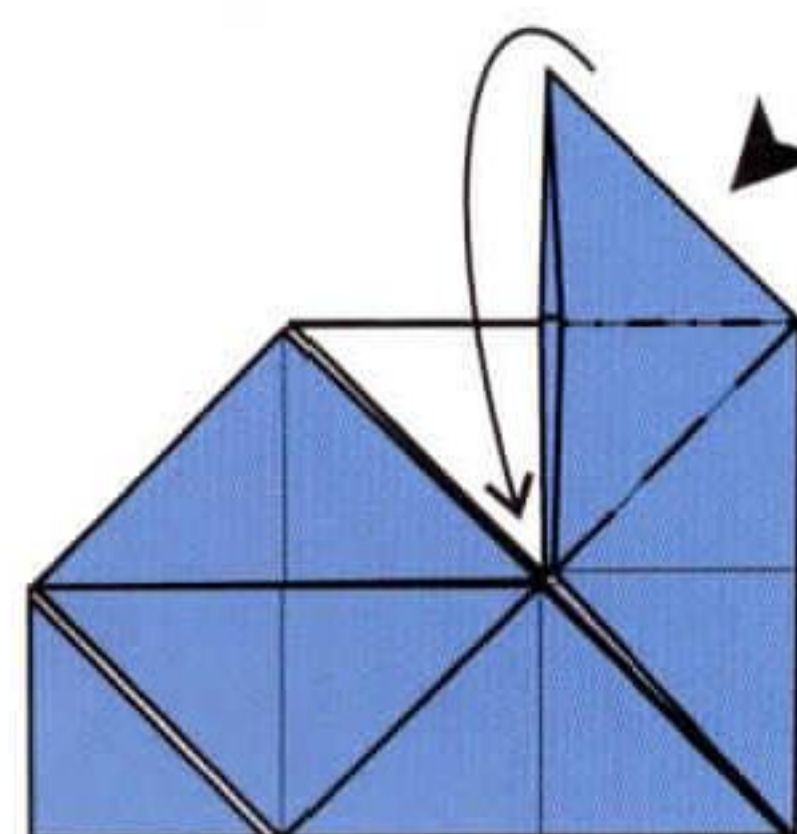

11 Open the layers of the point and squash flat.

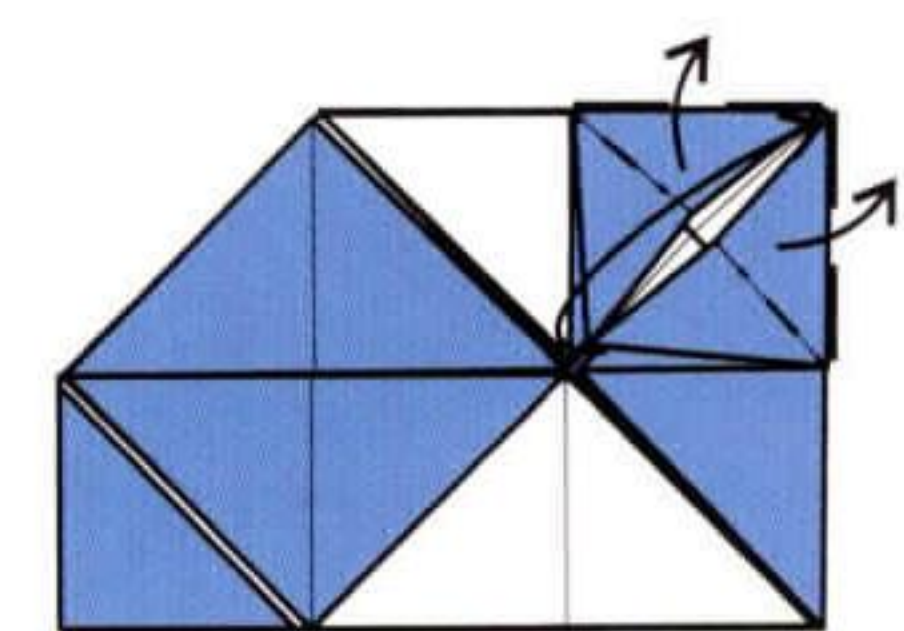

12 Fold the corner out and open out the point.

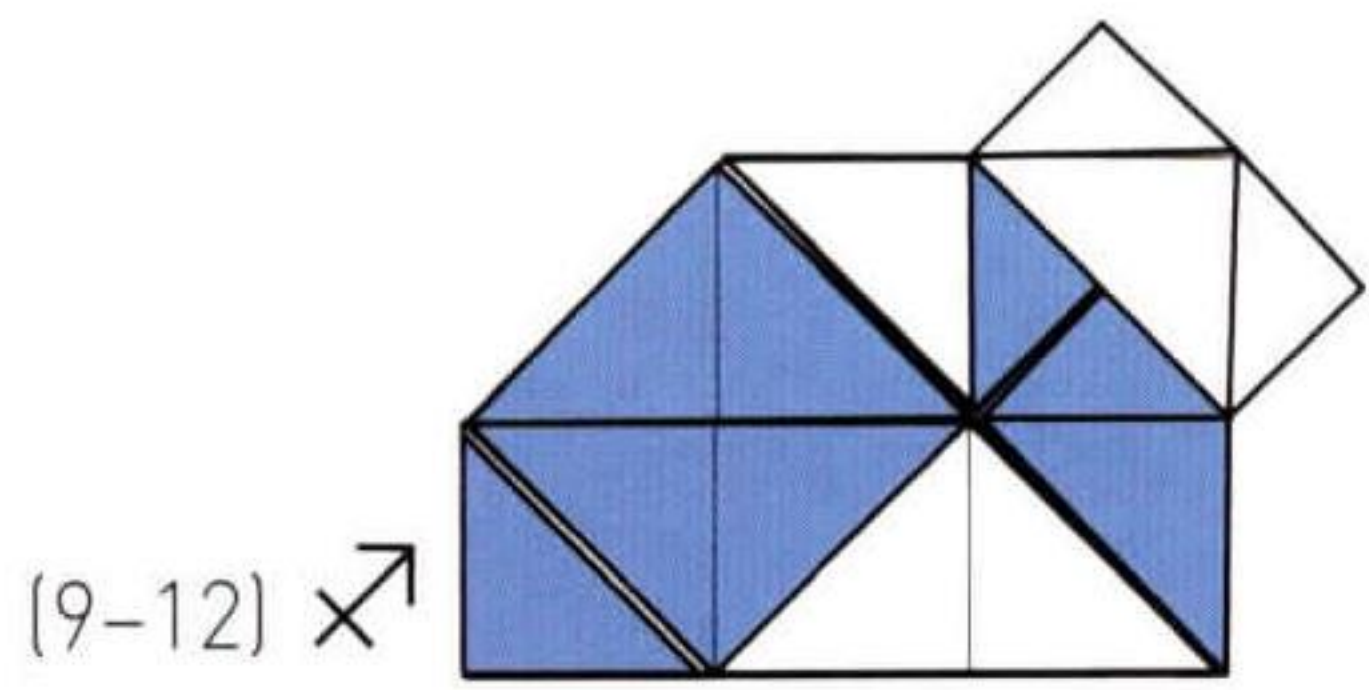

13 Repeat steps 9 to 12 on the other side.

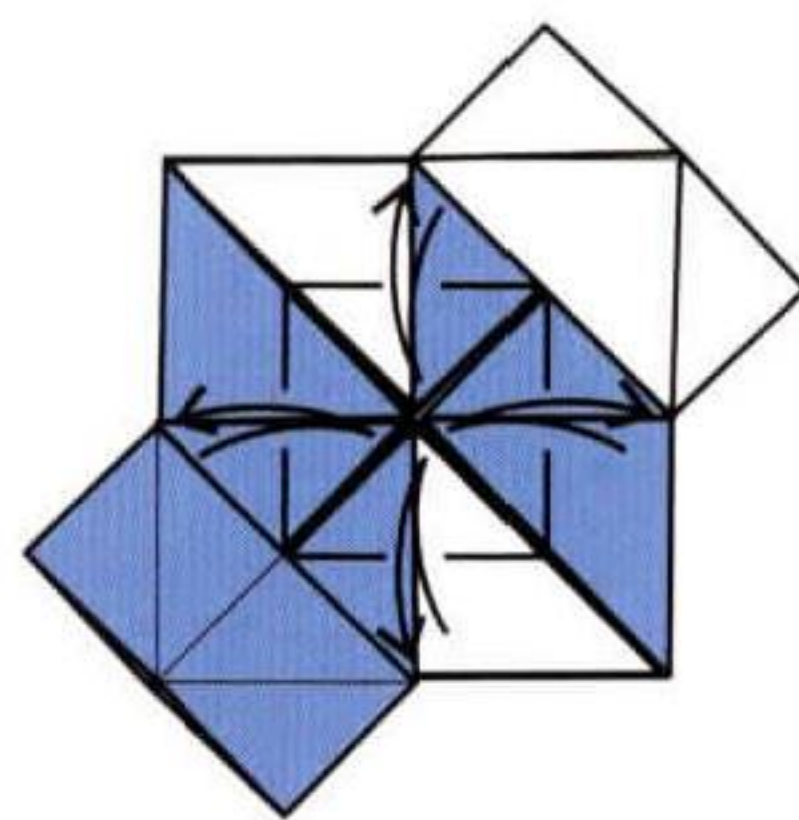

14 Fold and unfold the inner triangles out to the adjacent folded edge.

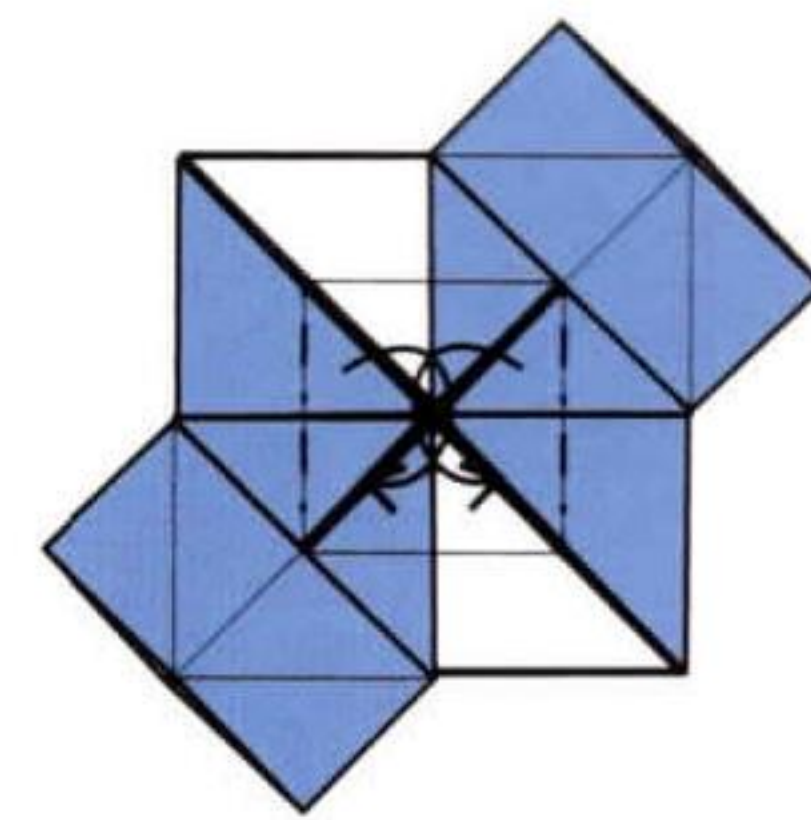

15 Fold the two corners behind and into the model.

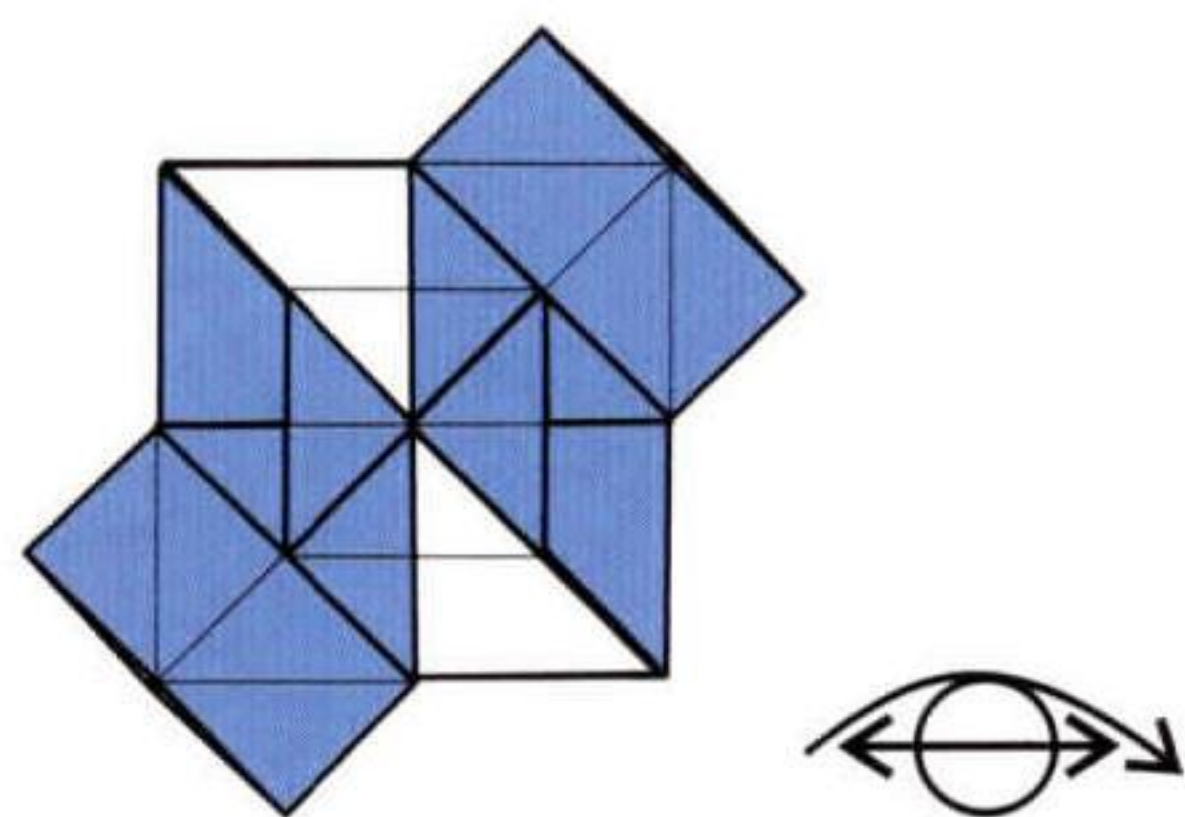

16 Turn the model over left to right.

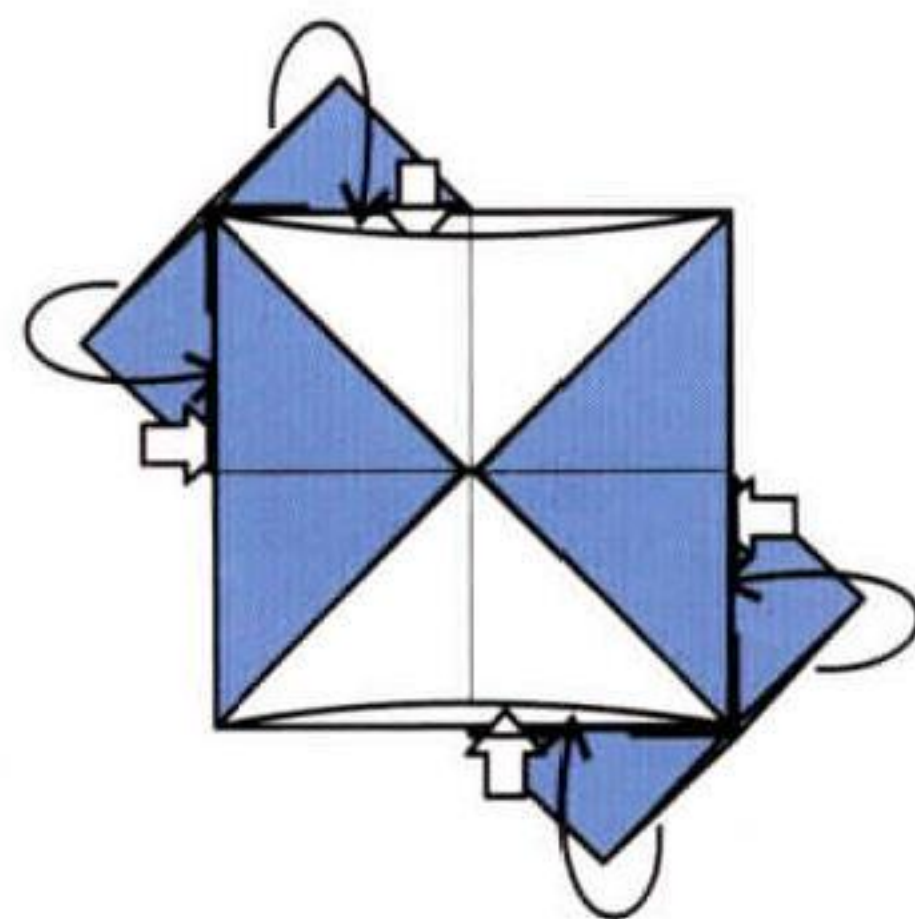

17 Fold the corners into the adjacent pockets.

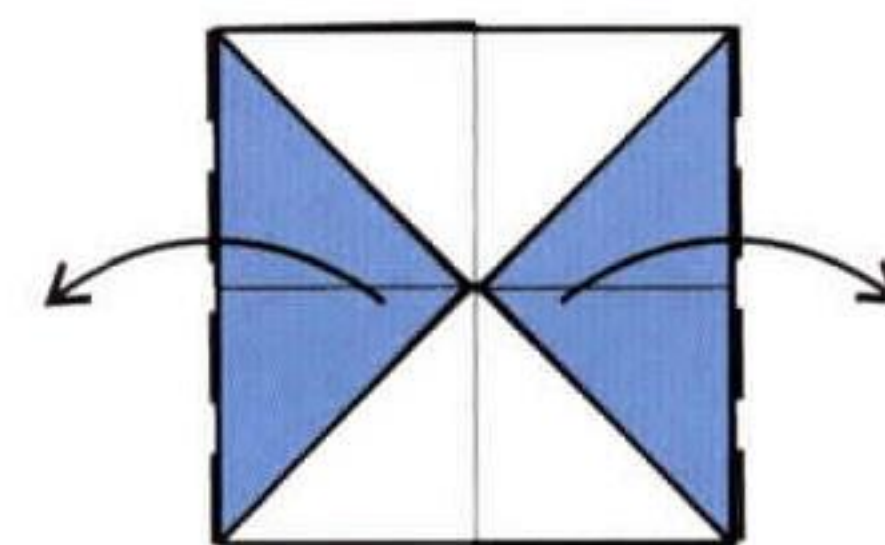

18 Fold the corners out.

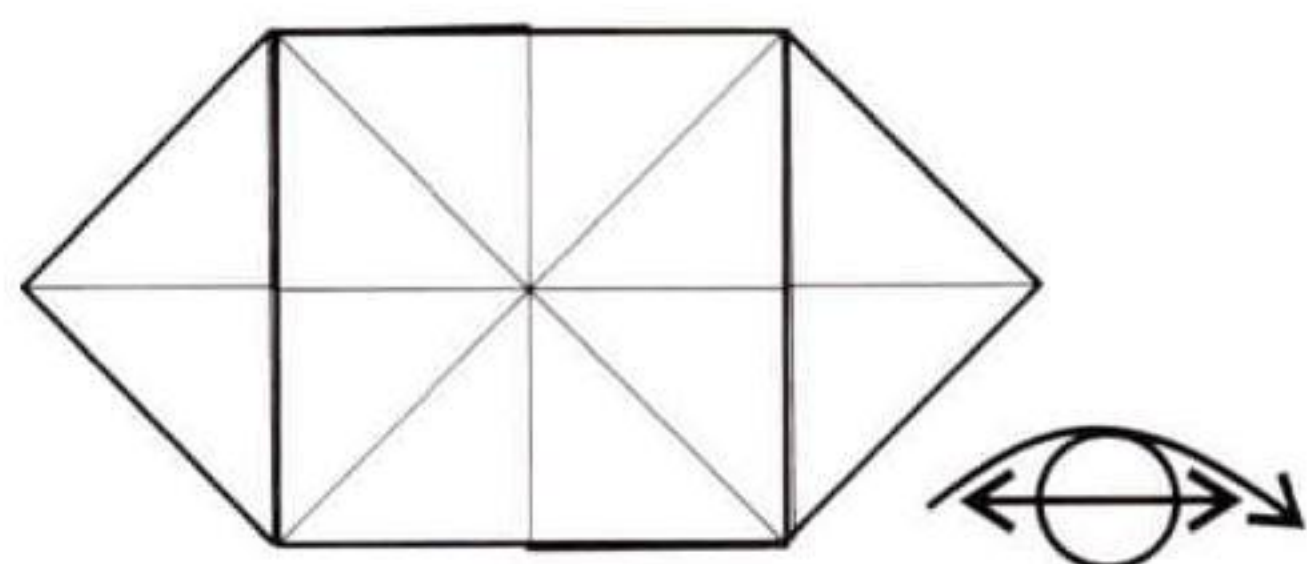

19 Turn the model over left to right.

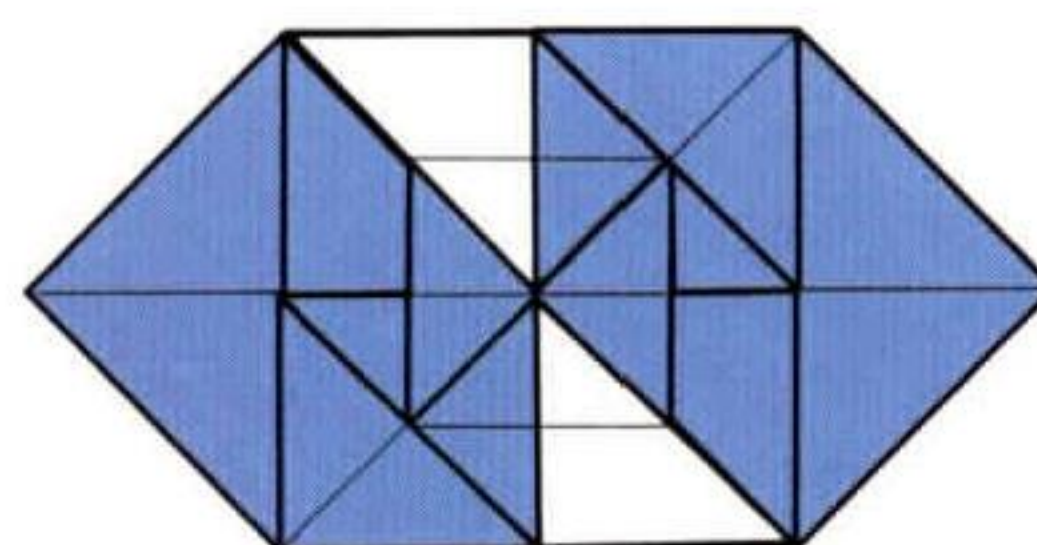
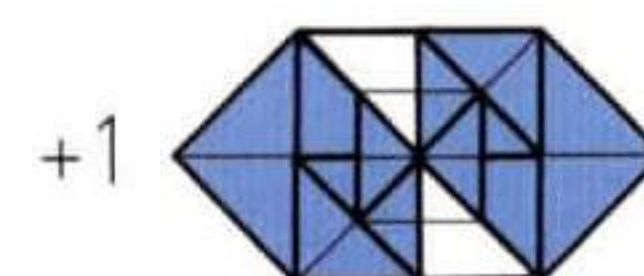

20 Unit complete. Add a second, and rotate one unit by 90°.

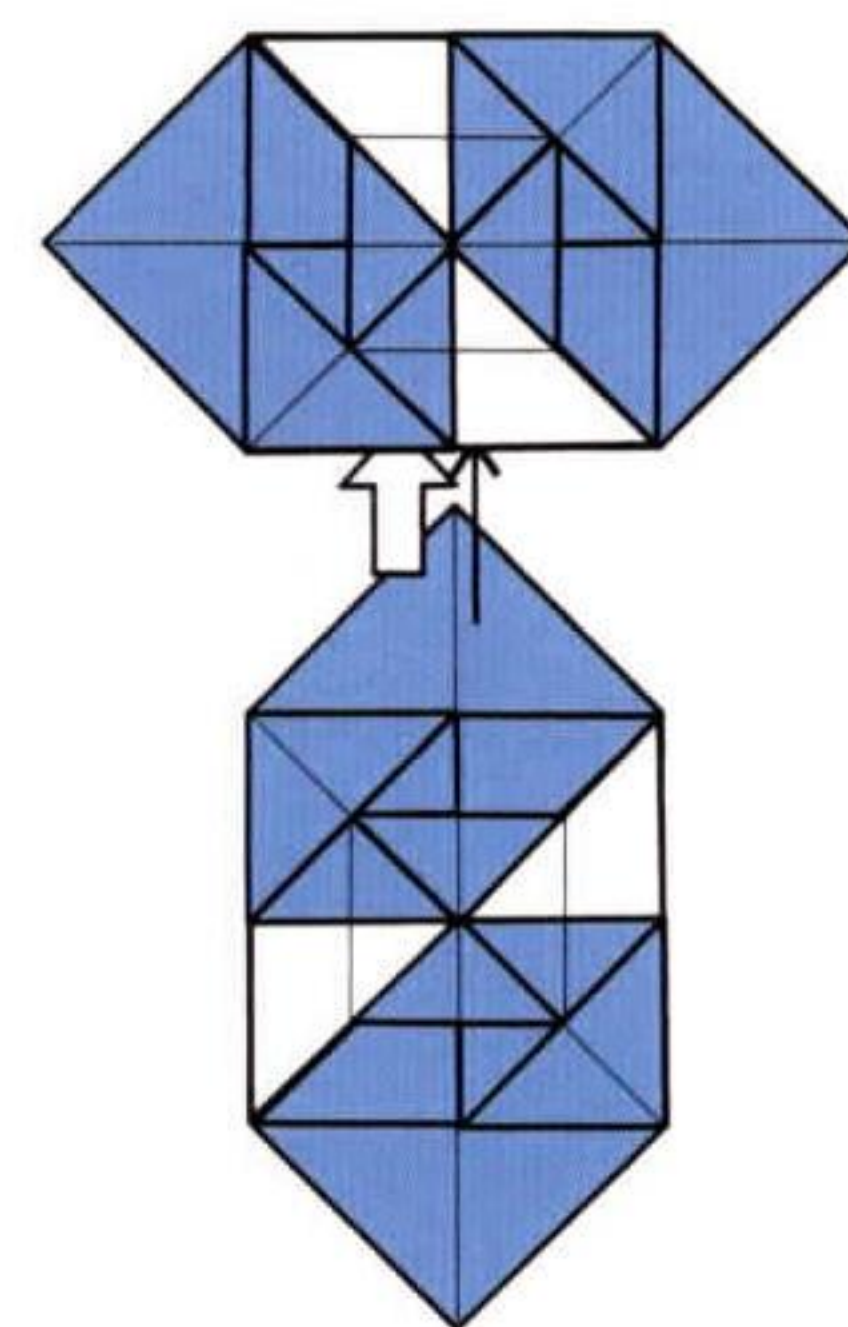

21 Insert the point of one unit into the pocket of the other.

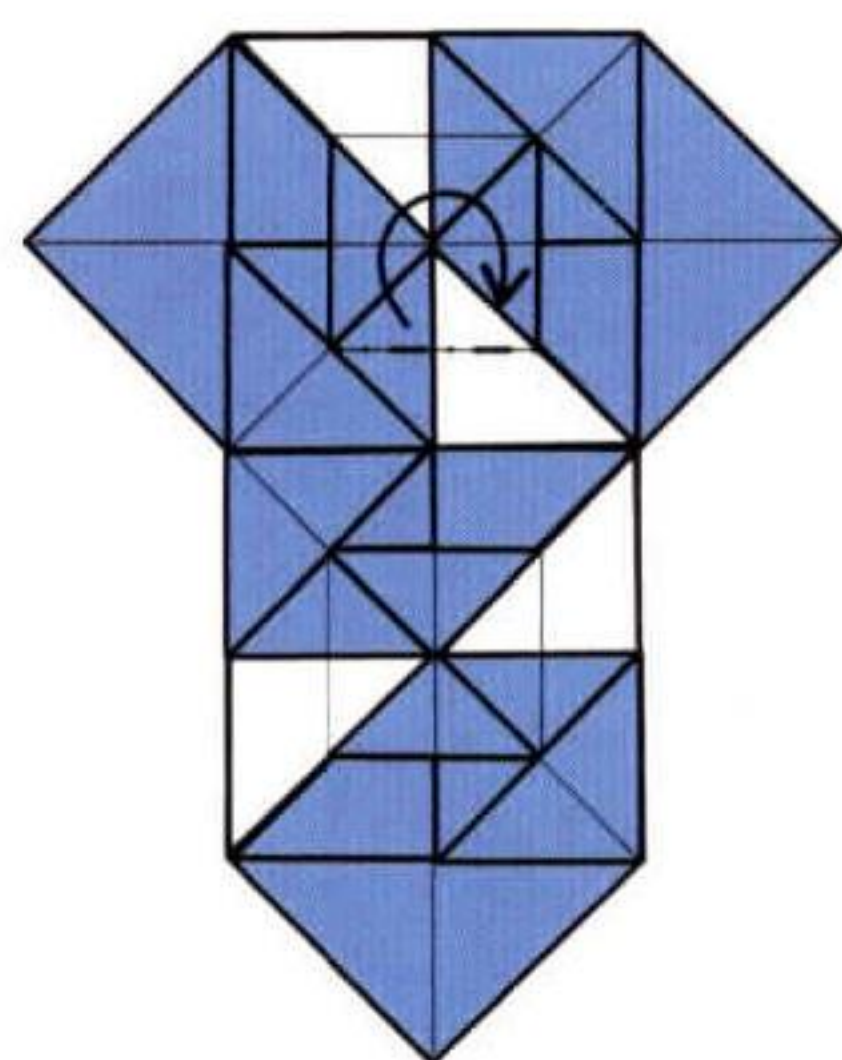

22 Fold the corner behind to connect the two units.

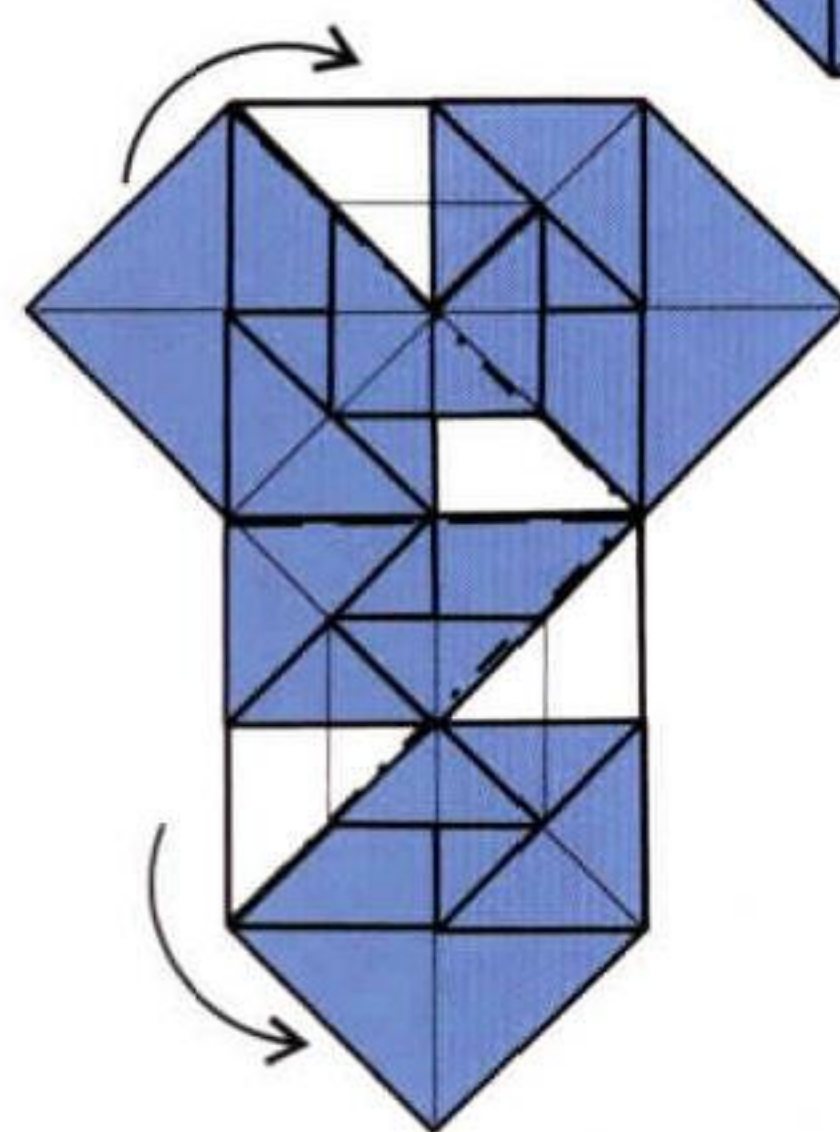
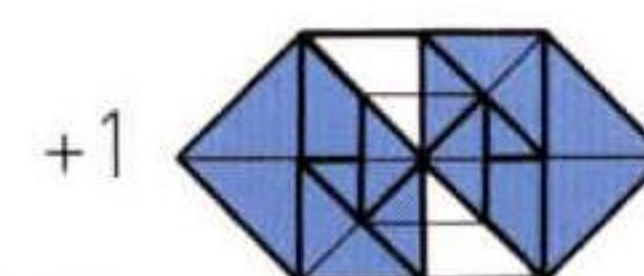

23 Fold the units diagonally and then add a third unit.

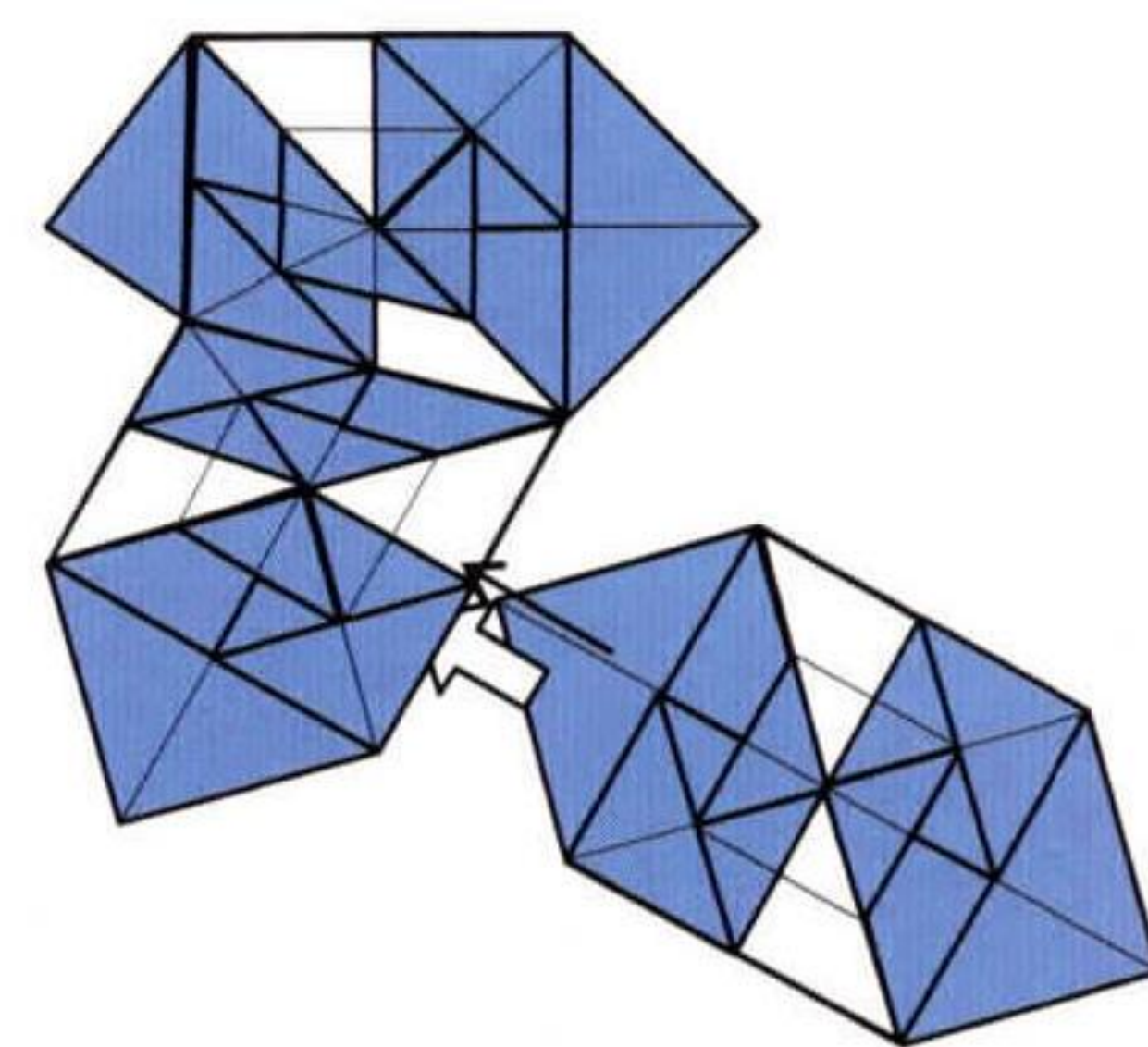

24 Insert the point into the pocket of the connected units.

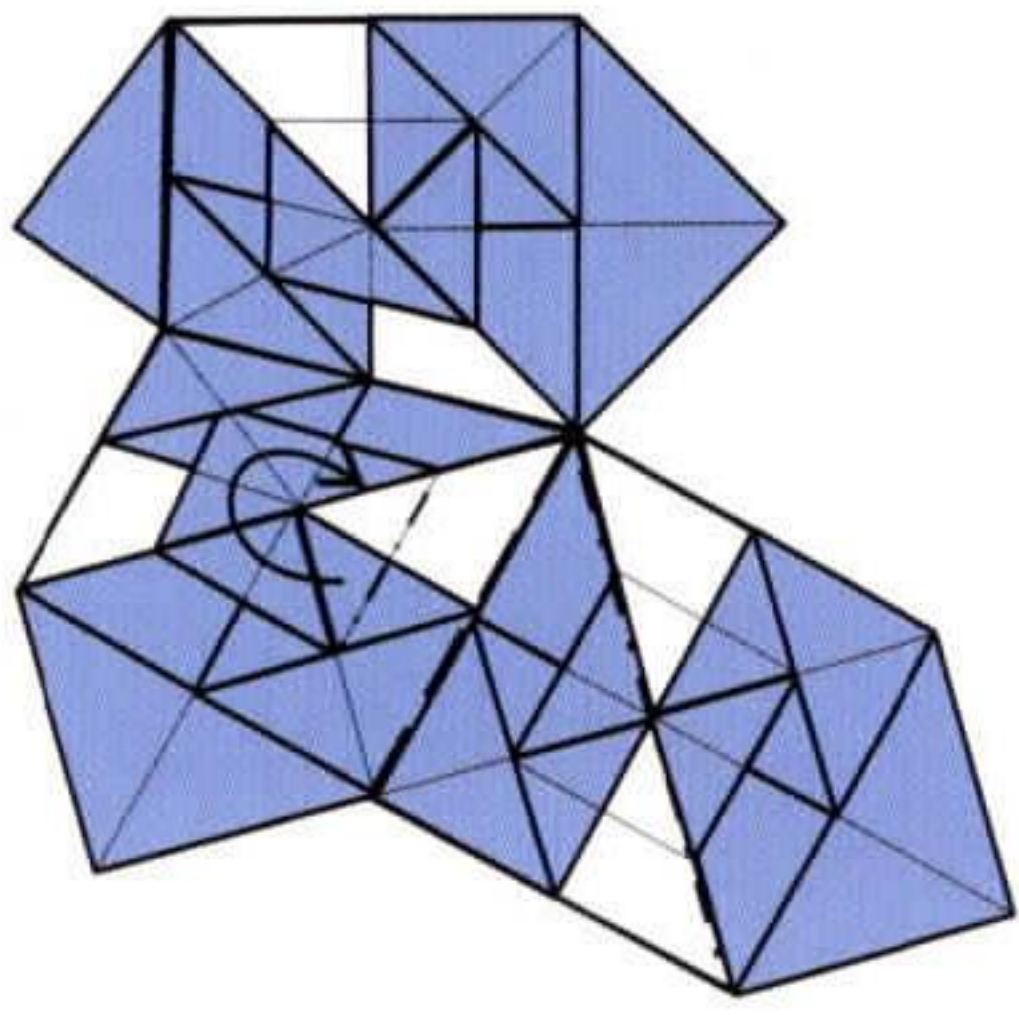

25 Fold the corner behind to lock the modules together.

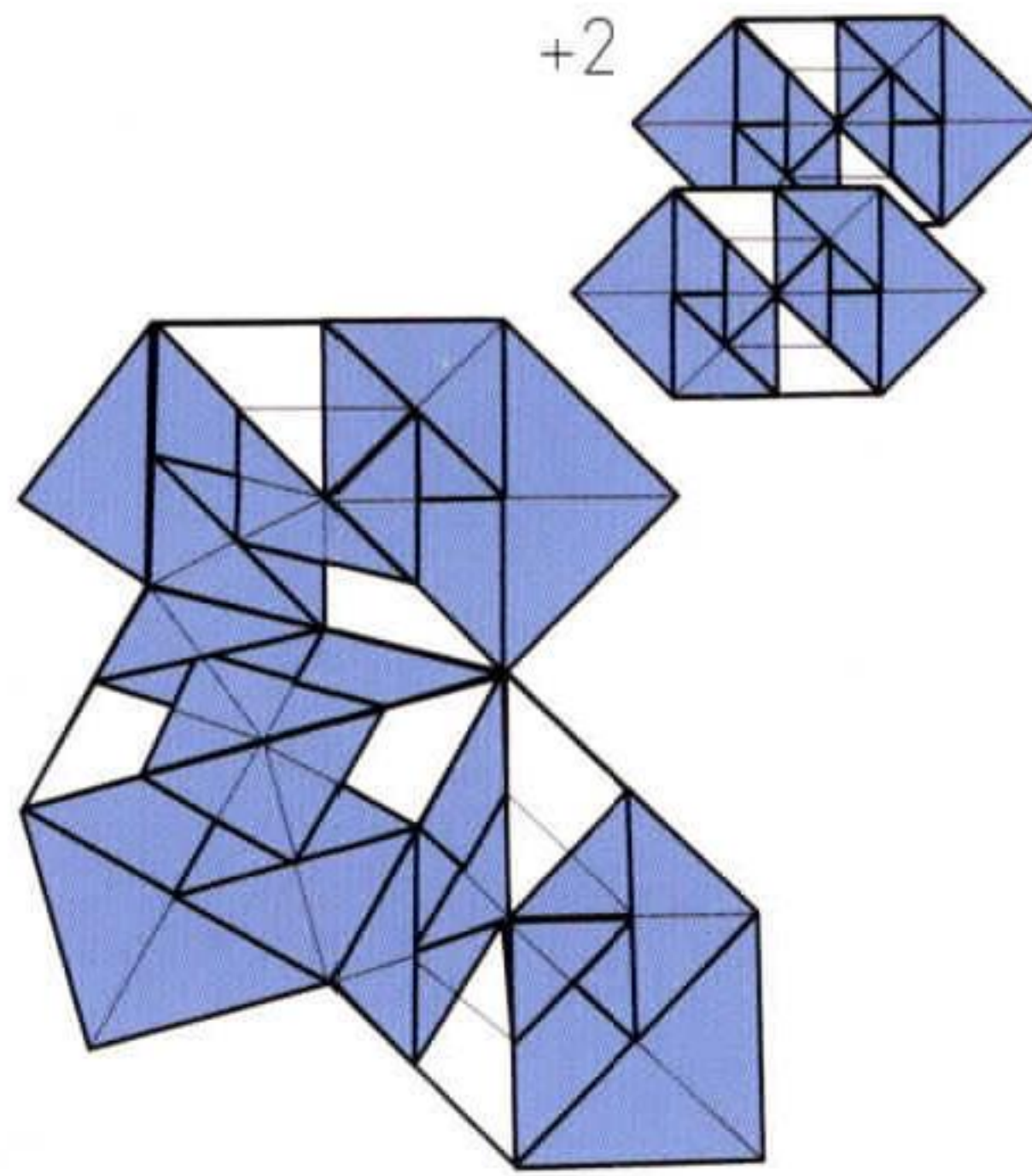

26 Add two more units to complete the ring of five units.

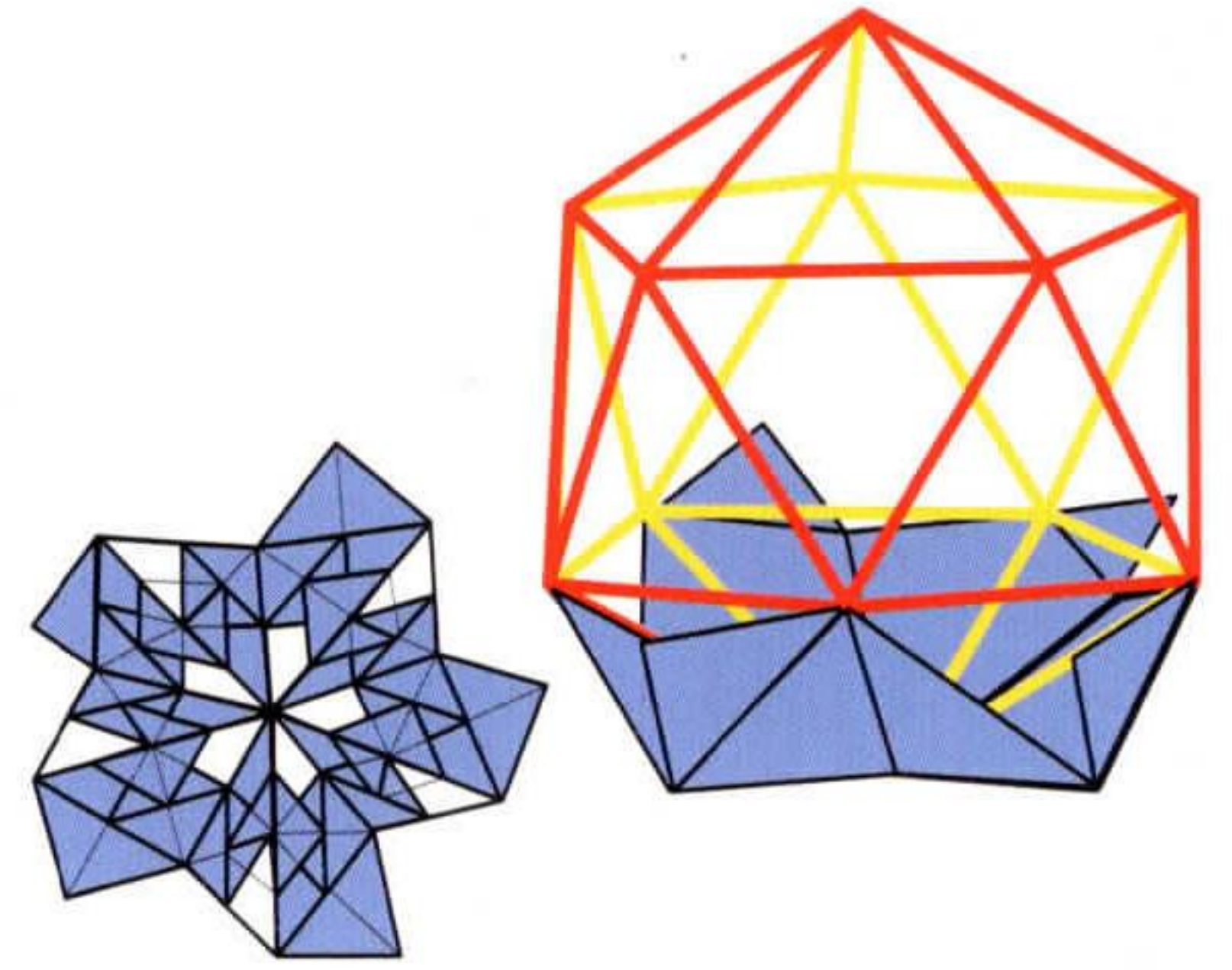

27 The five linked units form the base of the model. Turn it upside down and start to build the shape around an imaginary icosahedron.

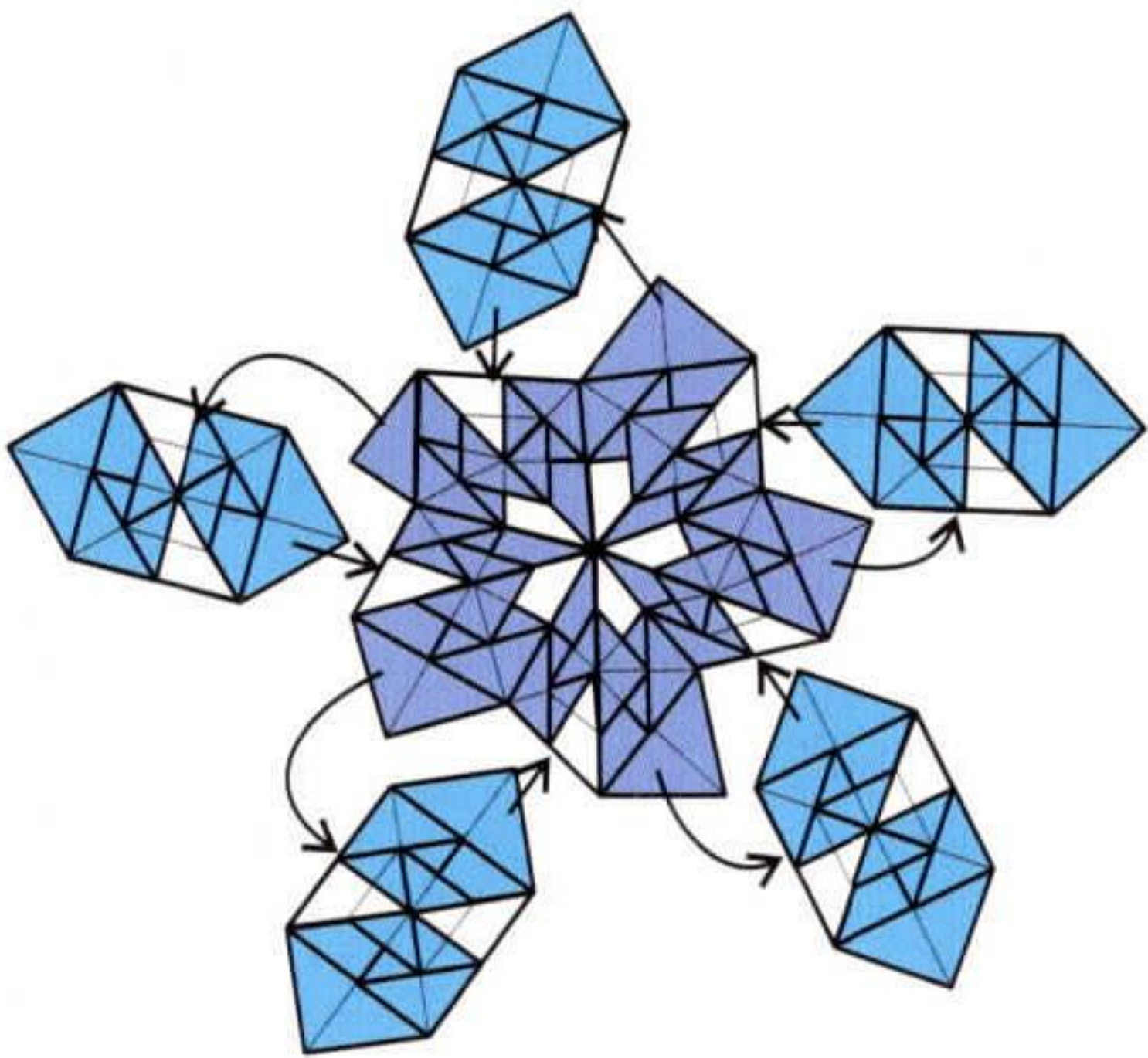

28 Add five more units to build up the shape.

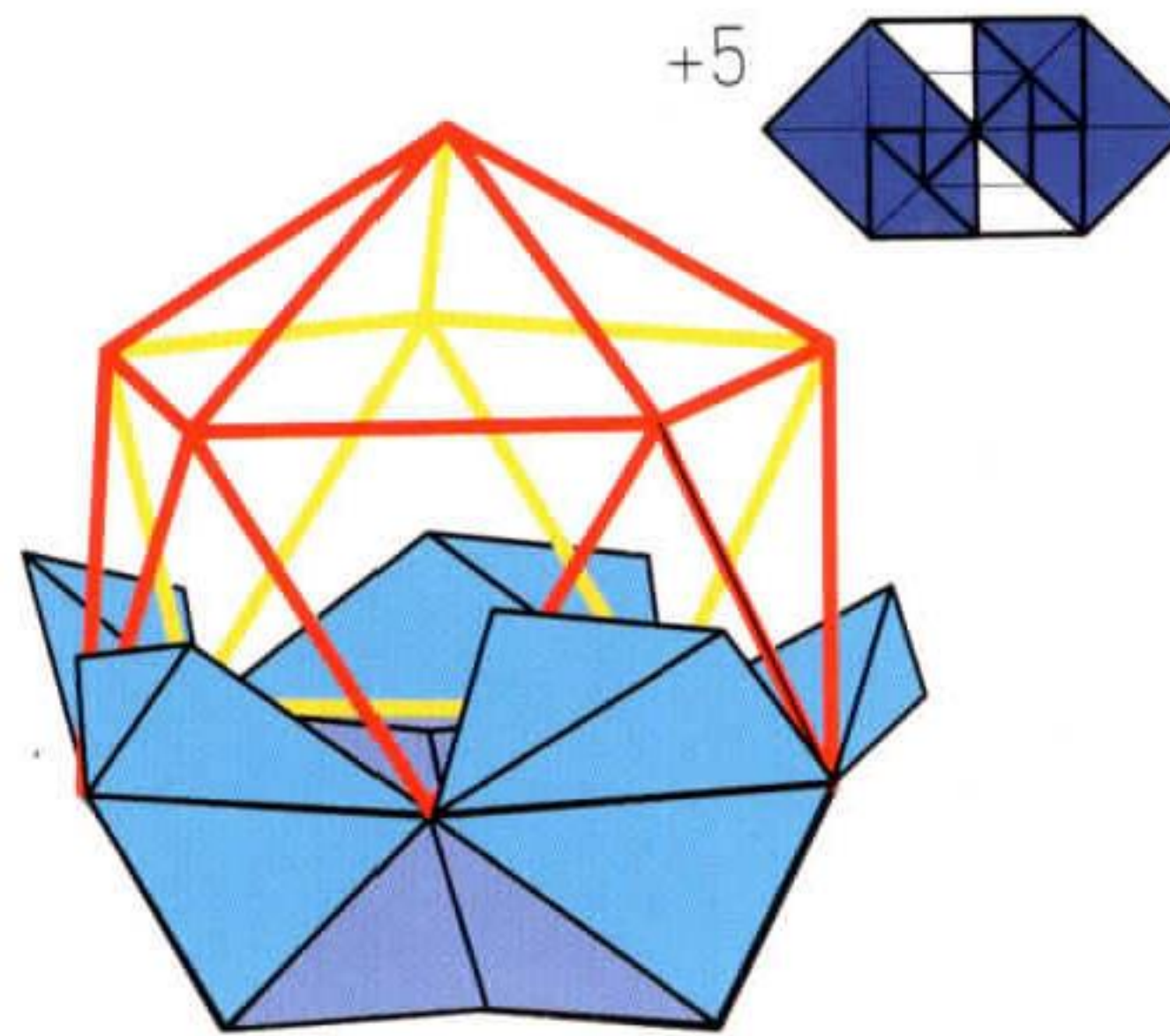

29 This shows two layers of assembled units. Add a third layer of five units.

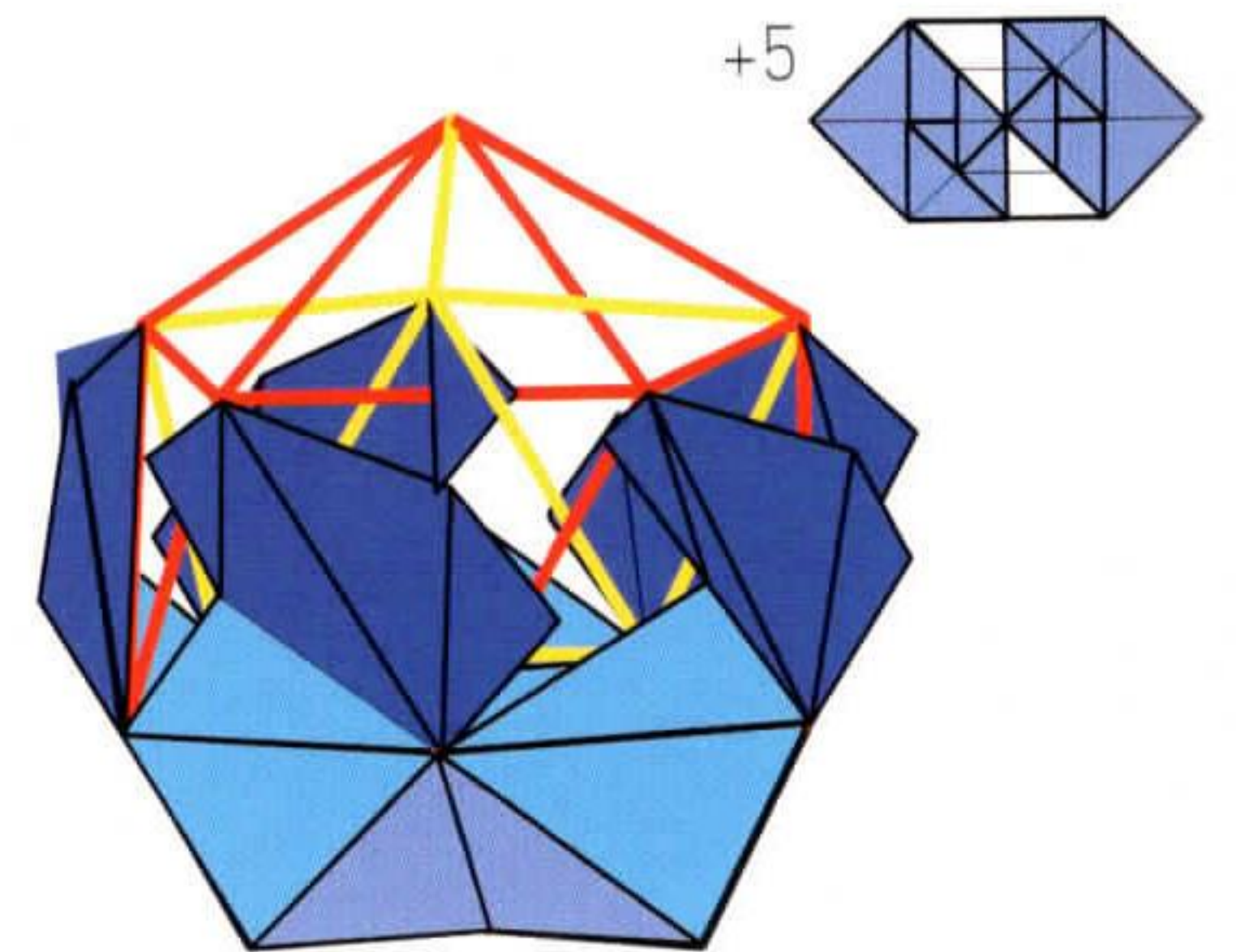

30 Add another layer of five units.

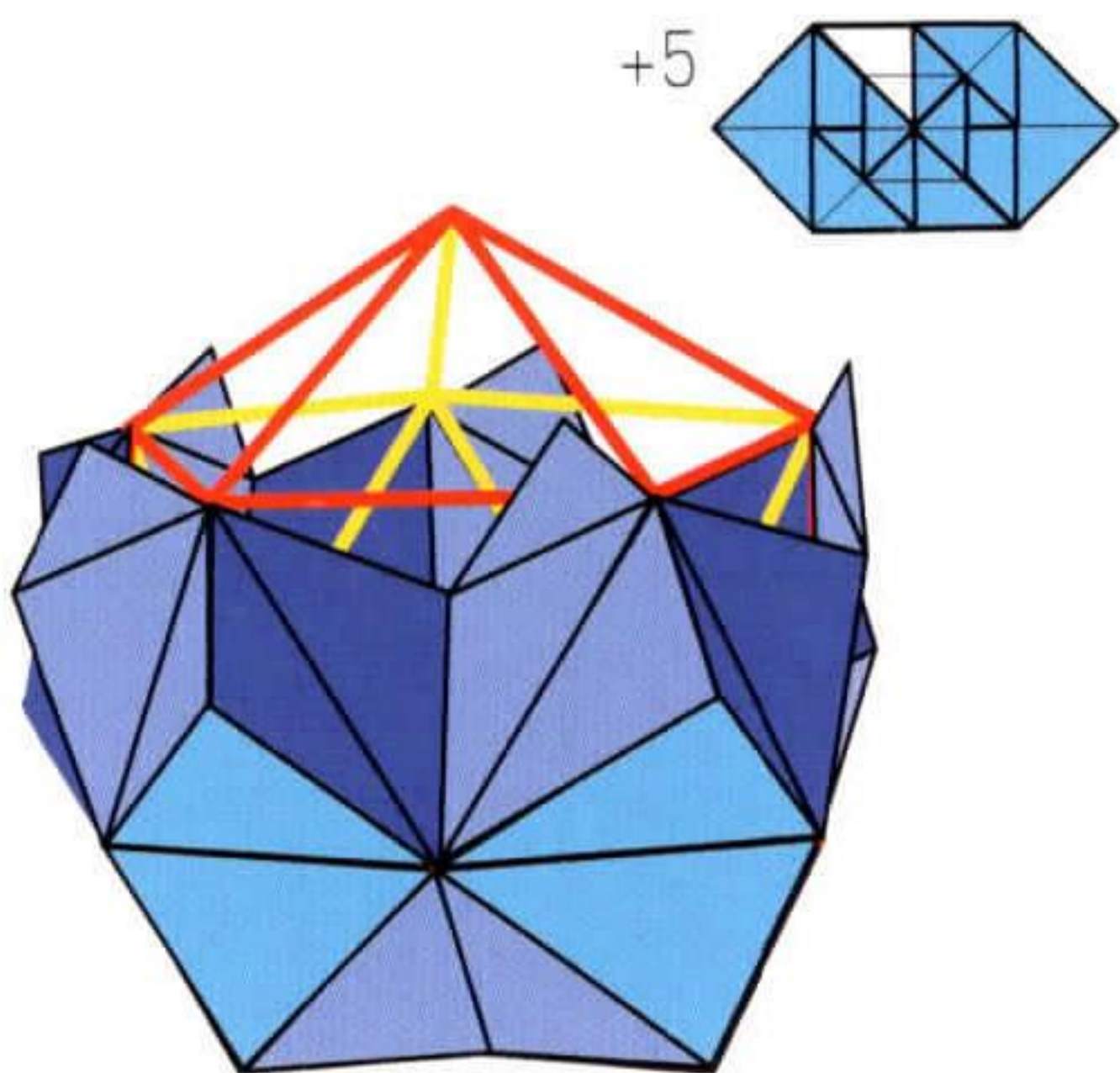

31 Add another layer of five units.

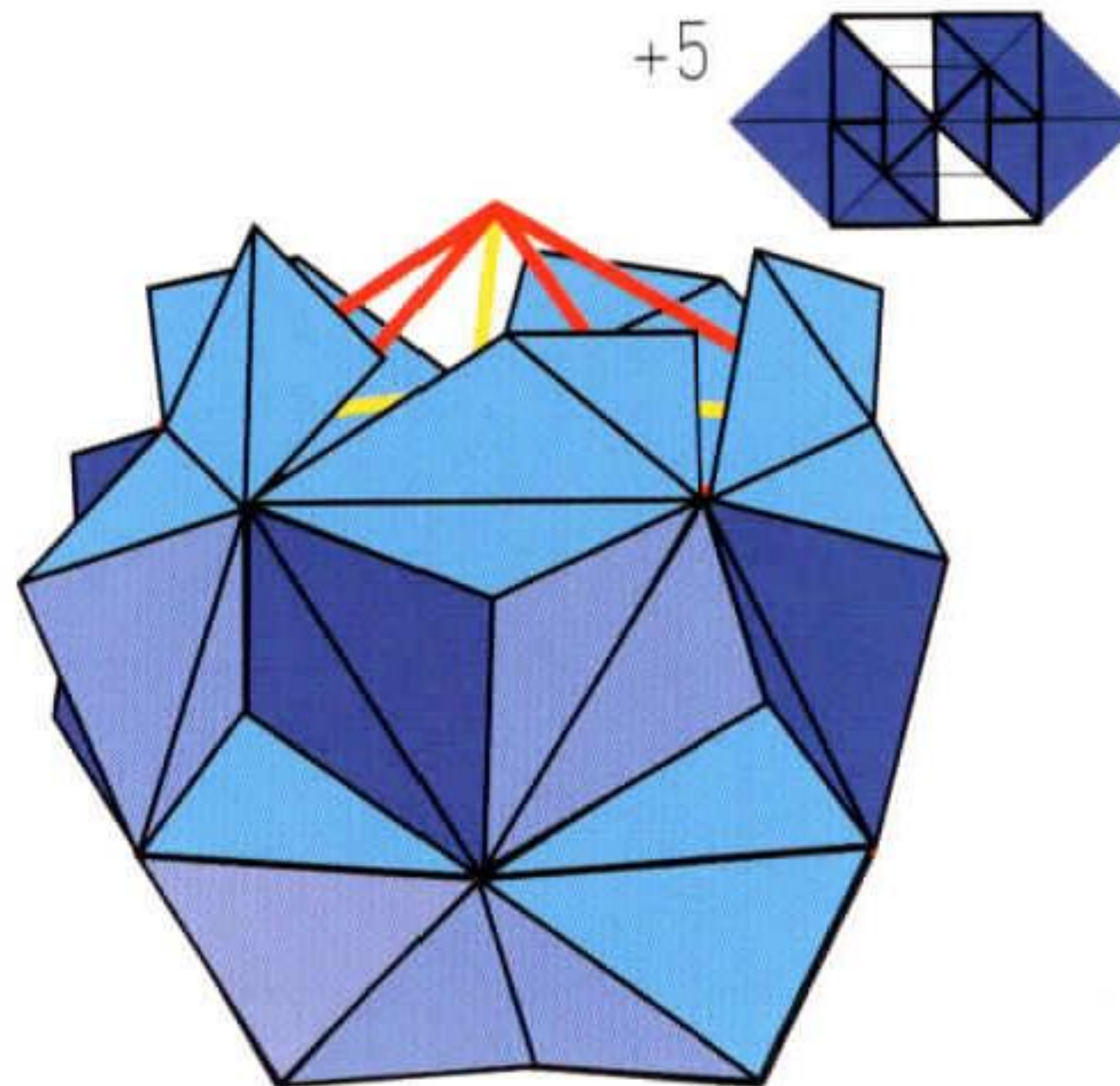

32 Add another layer of five units to complete the solid.

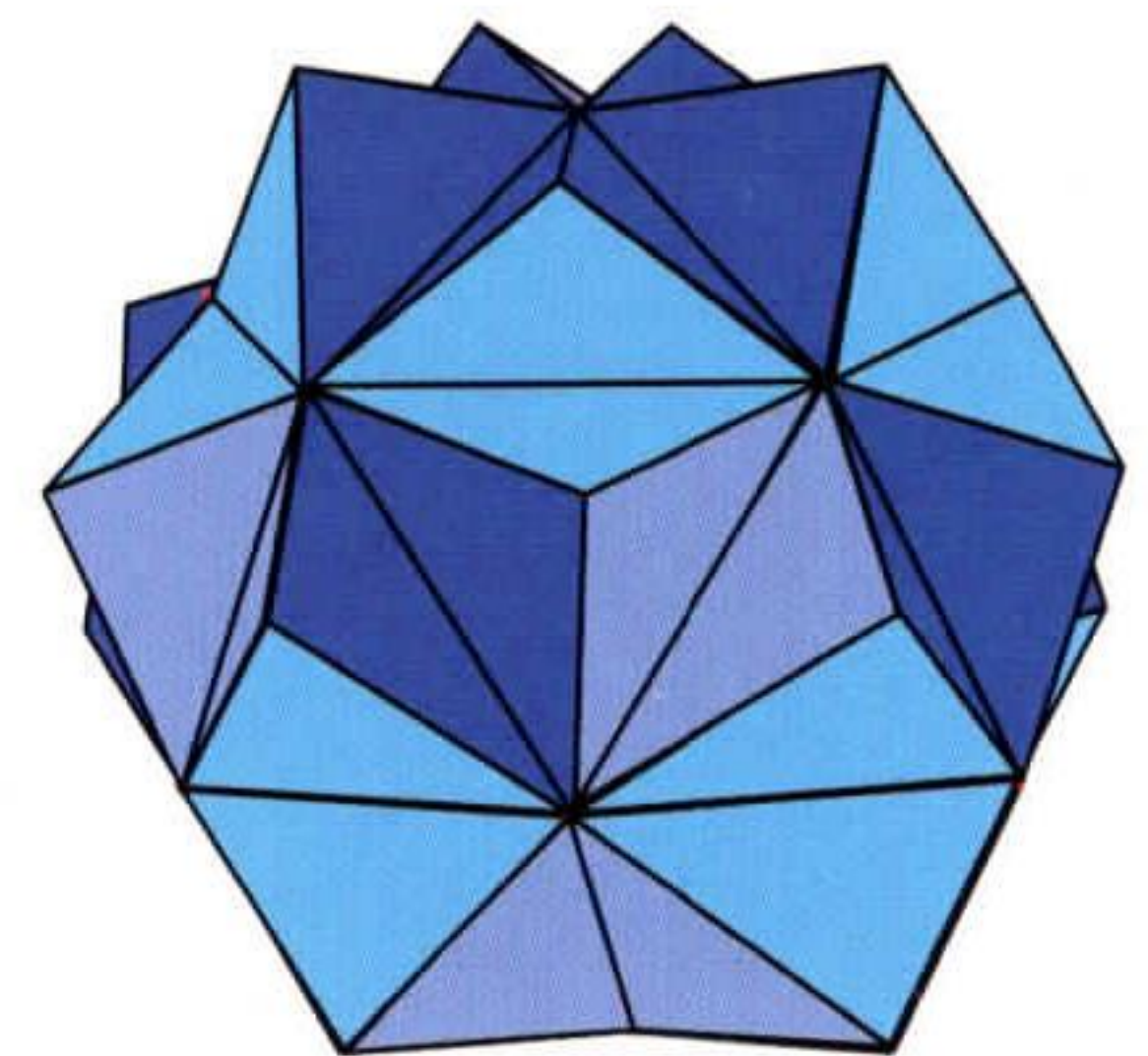

33 Complete. Other assemblies can be made from 1, 2, 3, 6 and 12 units.

The flower ball is made from 30 units assembled as a stellated icosahedron (a 20-sided icosahedron with each face being replaced by a three-sided triangular pyramid). The unit can be combined in other ways, with three units forming a tetrahedron, six forming a cube and 12 units making a stellated octahedron.

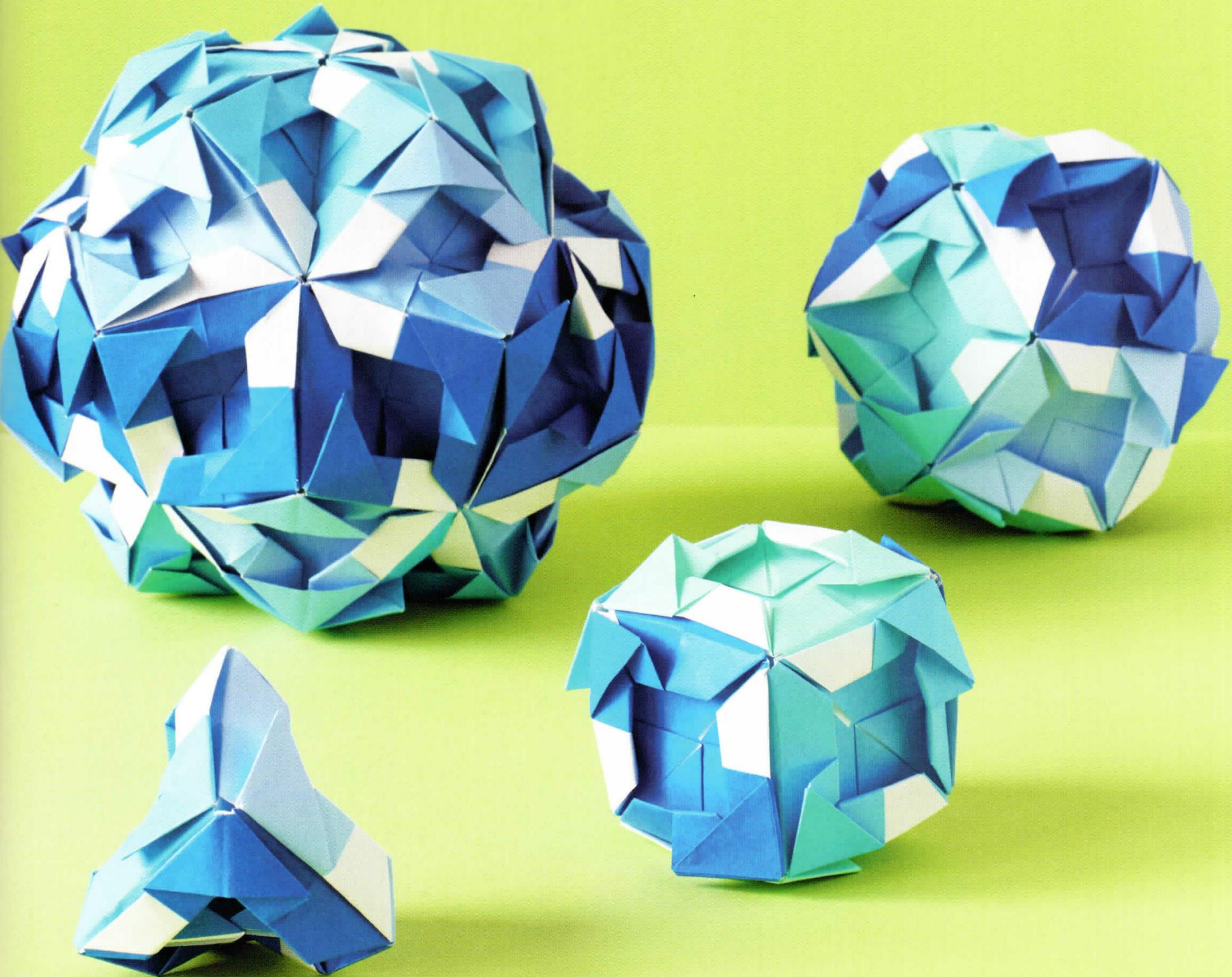

Vertex Module

**

This modular project makes a unit that can be used to form the edge of a polygon. The module is quite flexible and can be used to make a variety of shapes. The 90-unit construction is made from a 3D tessellation of regular hexagons and pentagons.

9 X 4.5CM (3½X 1¾IN)

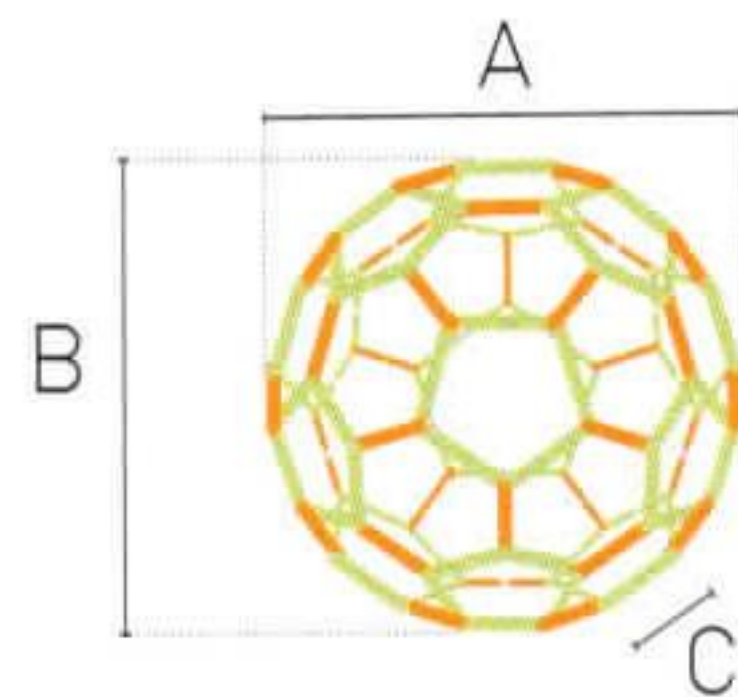
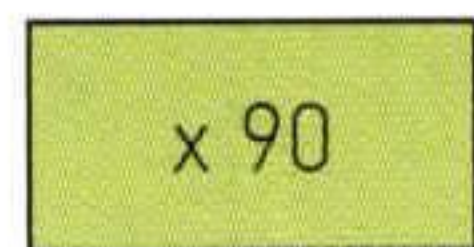

A 18cm (7in)
 B 18cm (7in)
 C 18cm (7in)

THE TRUNCATED ICOSAHEDRONS, OR FOOTBALL-SHAPED ASSEMBLY, IS MADE FROM 90 UNITS. FOR EACH UNIT START WITH A 2 X 1 RECTANGLE, COLOURED SIDE DOWN.

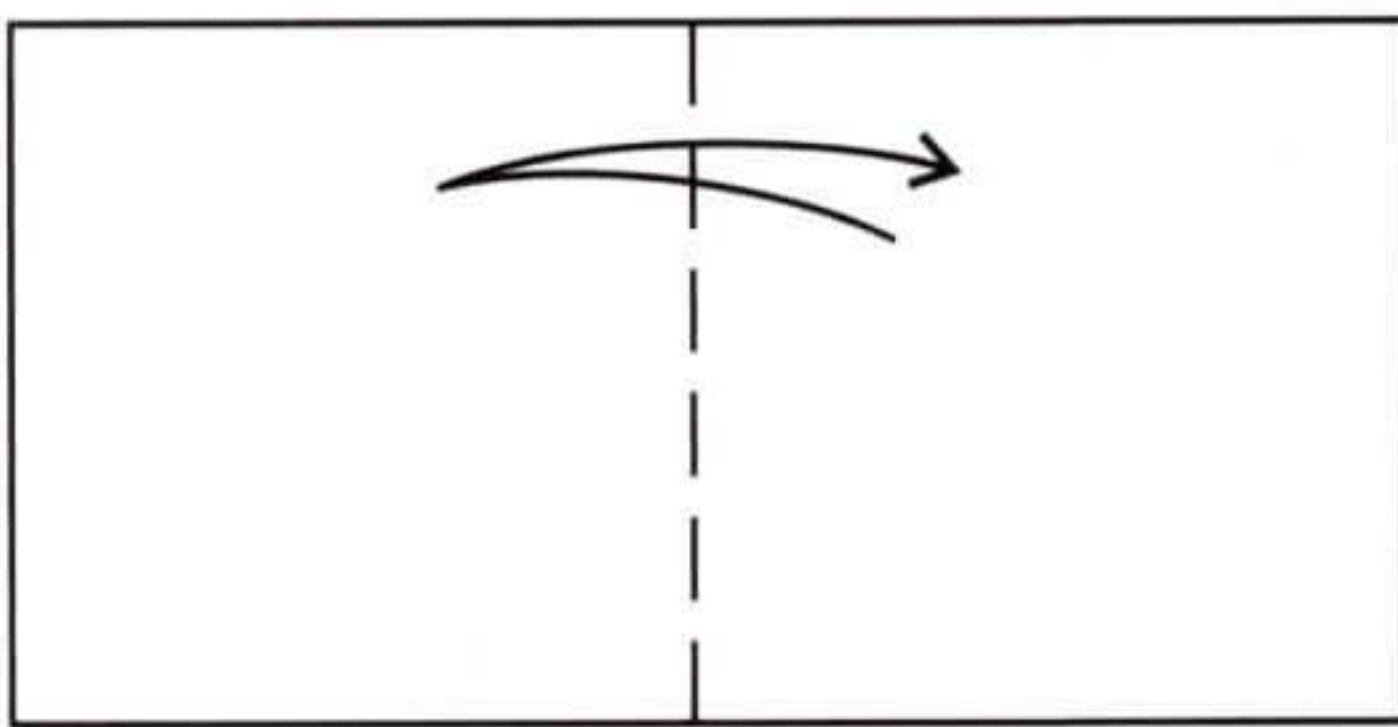

1 Fold and unfold the rectangle along the middle.

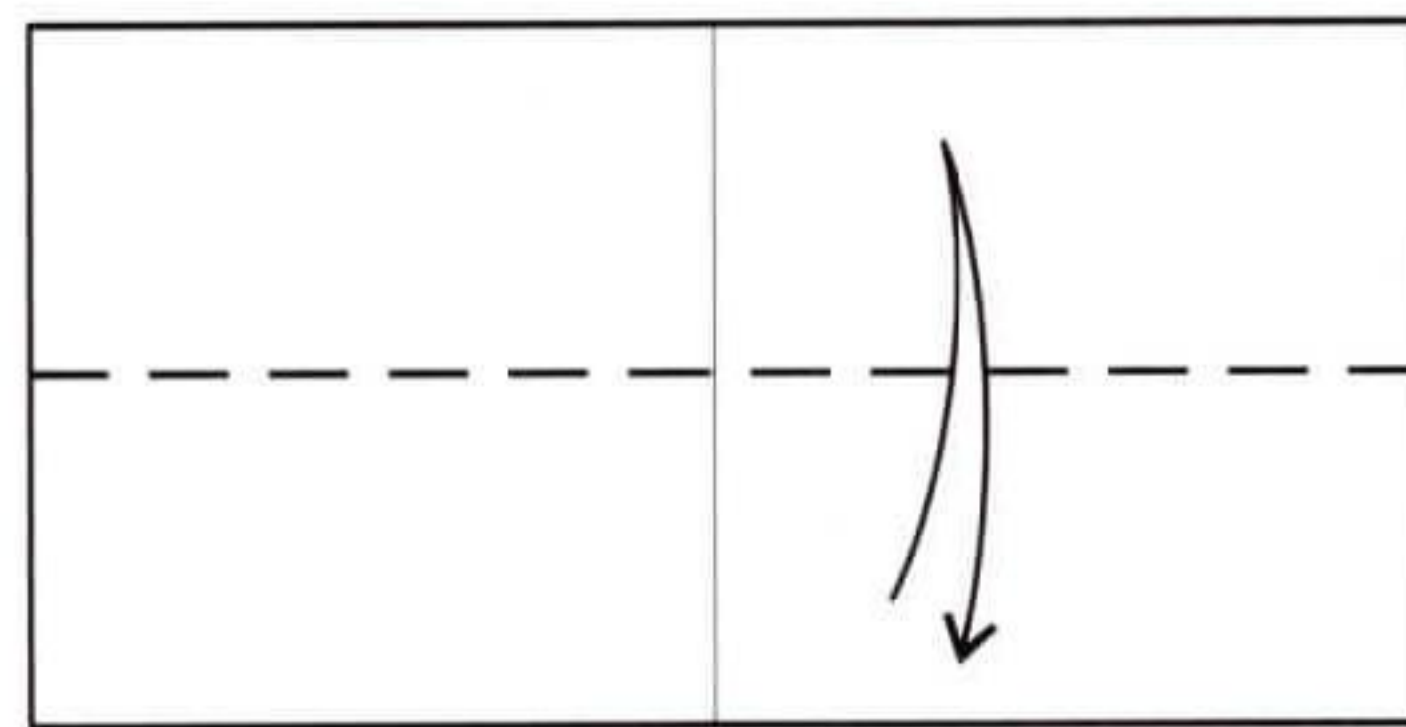

2 Fold and unfold along the middle of the other axis.

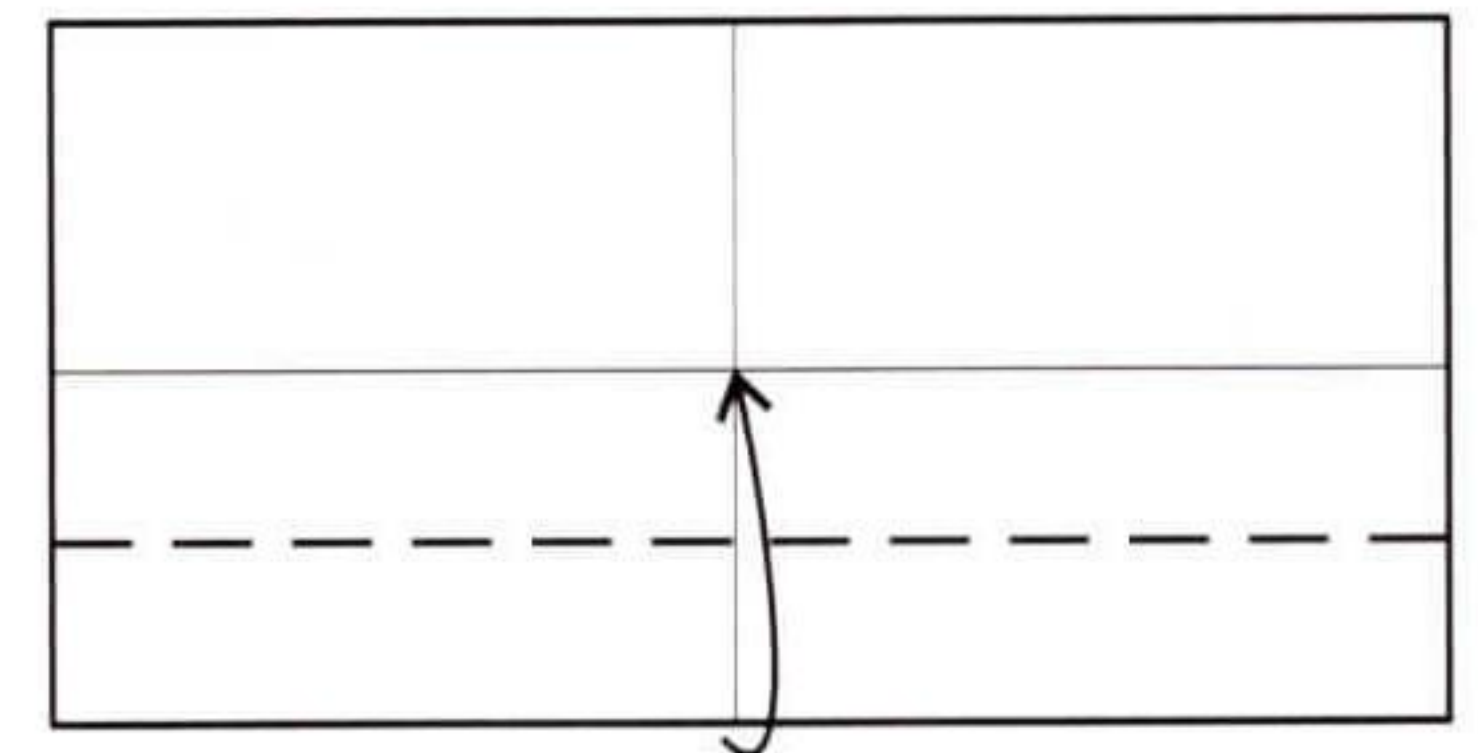

3 Fold the lower edge up to the middle crease.

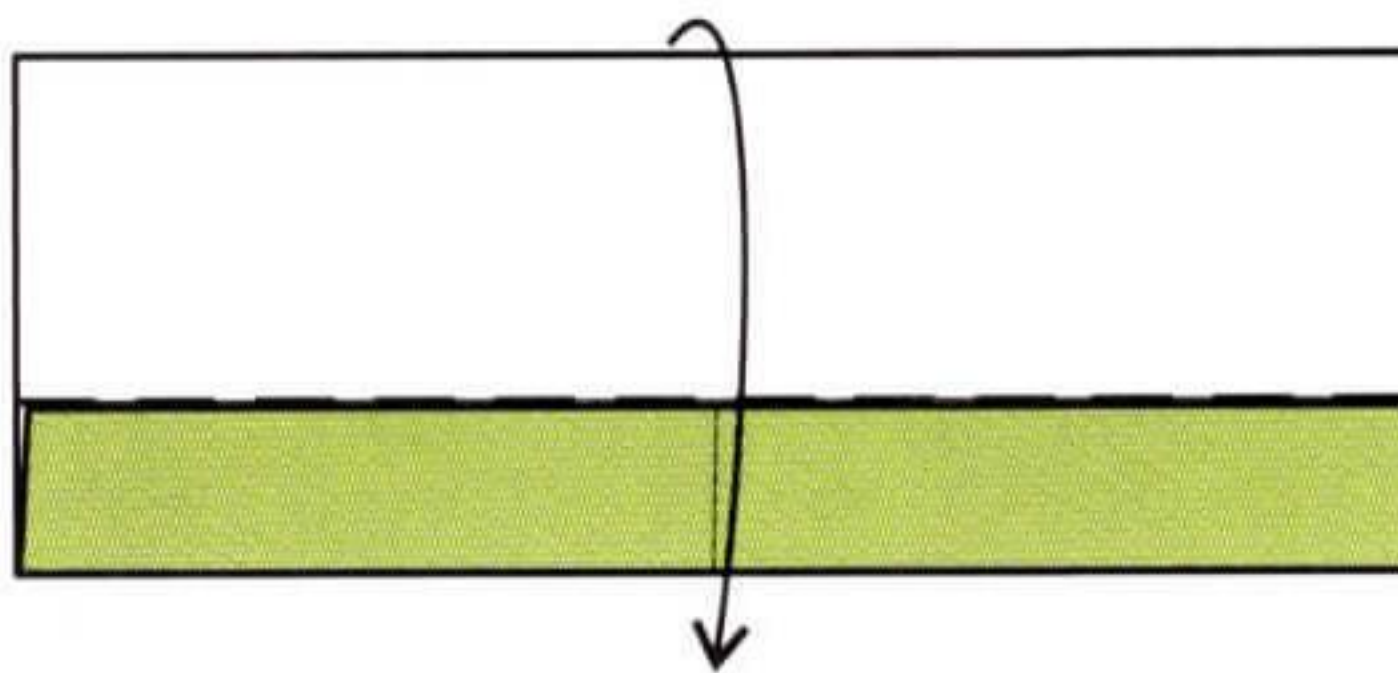

4 Fold the upper edge over.

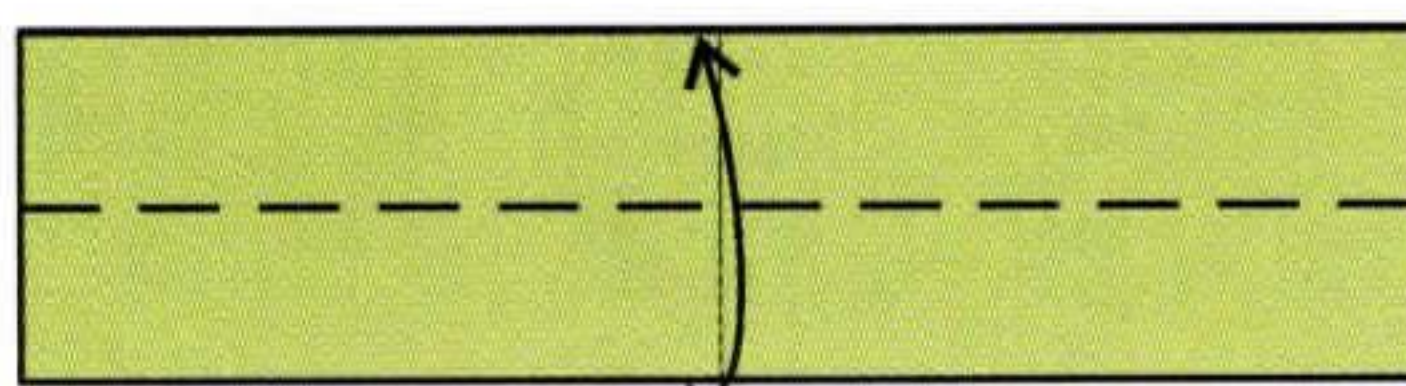

5 Fold the lower edge up.

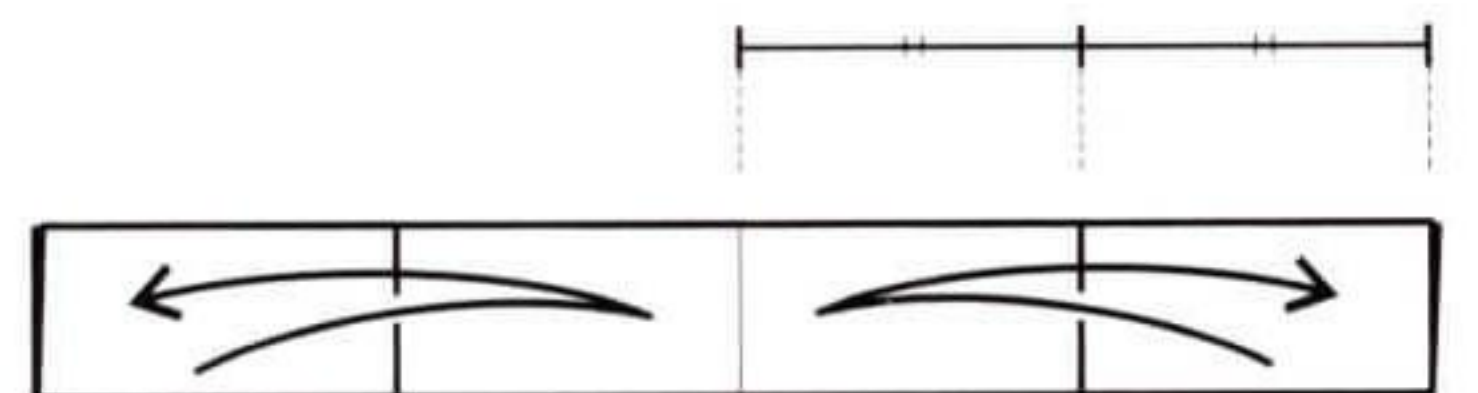

6 Fold and unfold the outer edges to the middle.

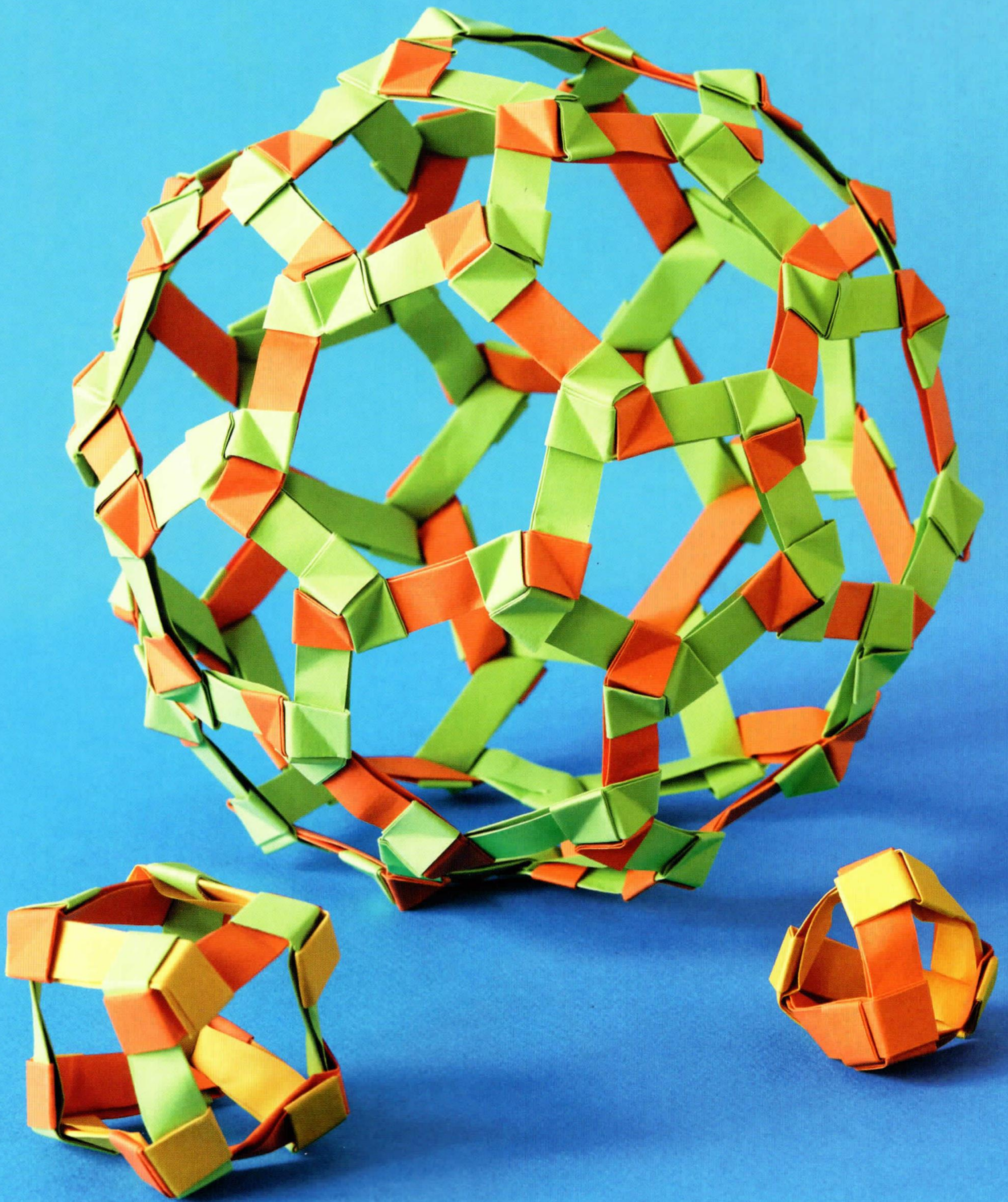



7 Fold and unfold the outer edges to the creases made previously.

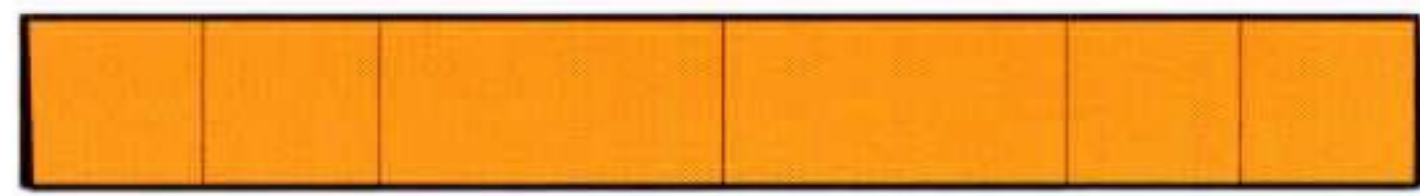
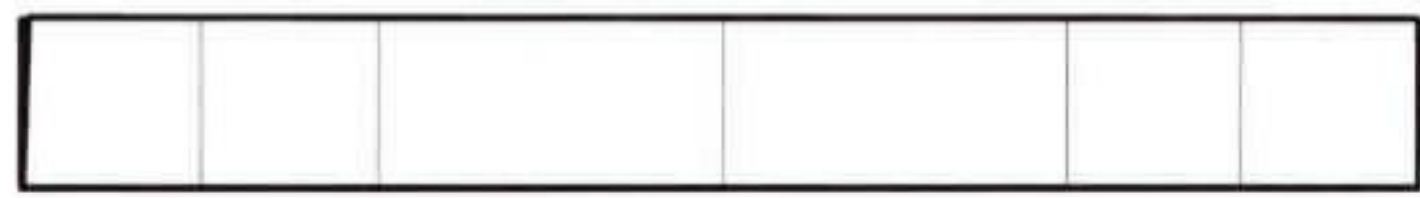

90°

8 Make another unit, coloured side up. Then rotate one 90°.

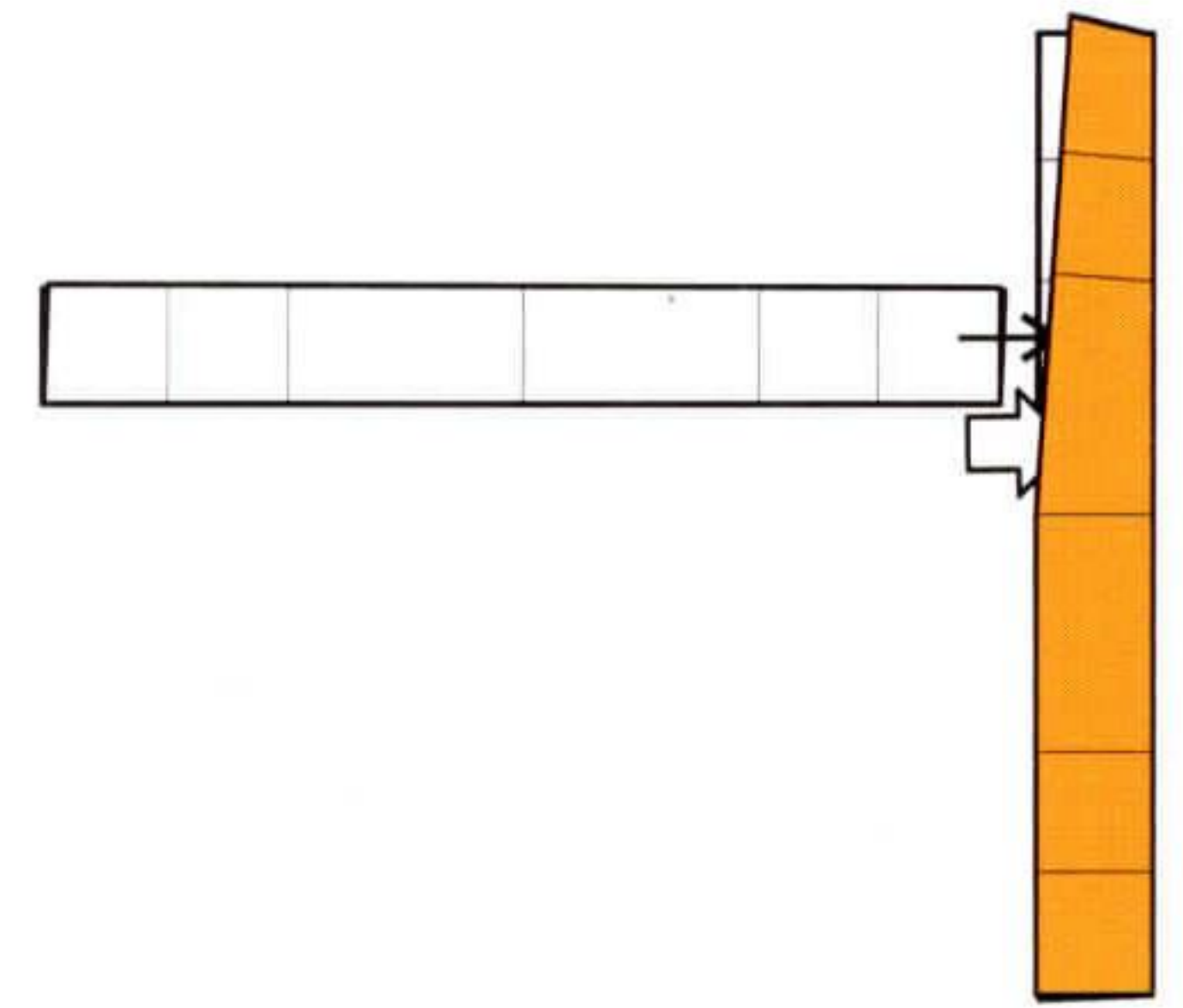

9 Insert one end between the layers of another unit.

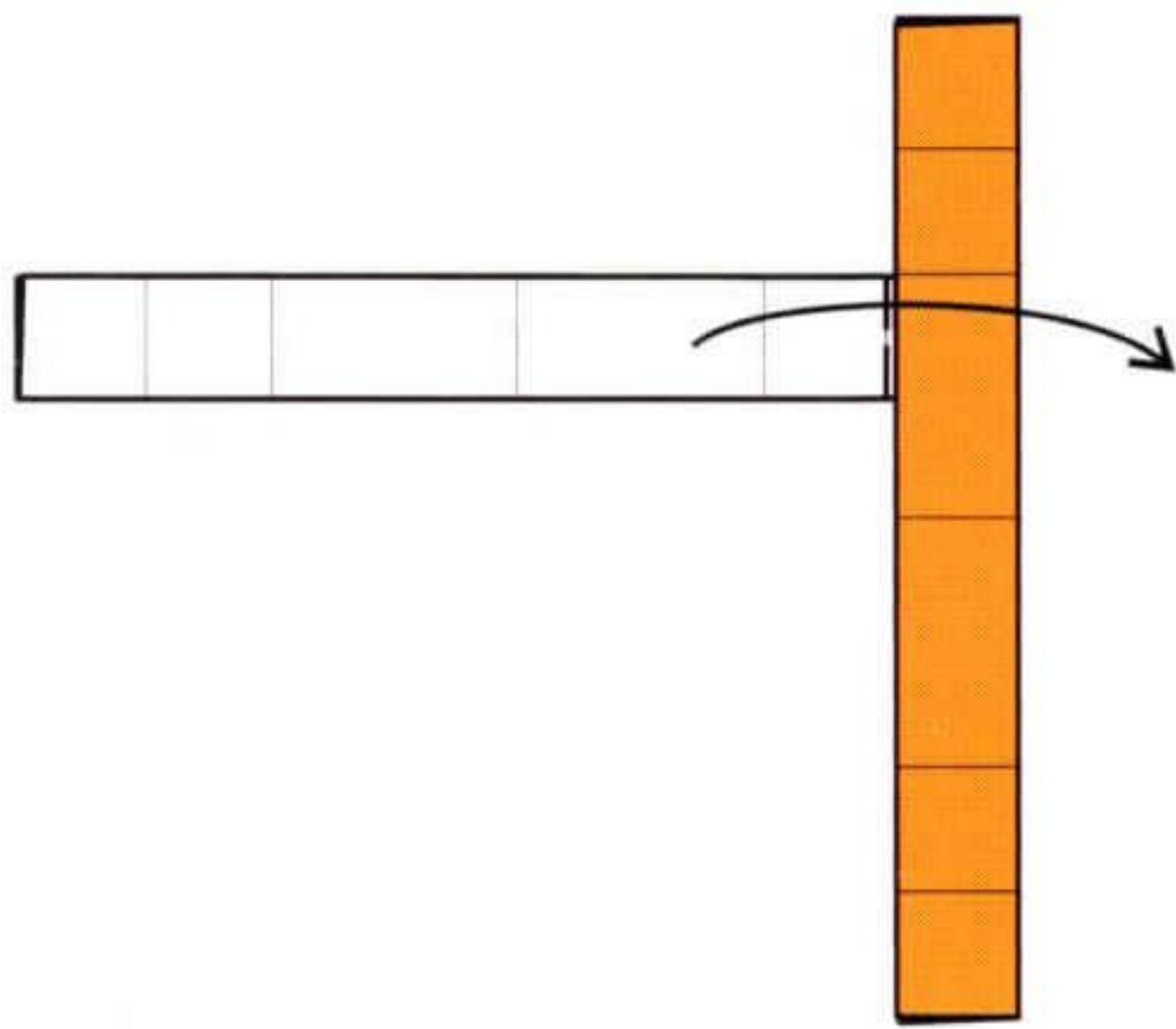

10 Fold the inserted unit over the other.

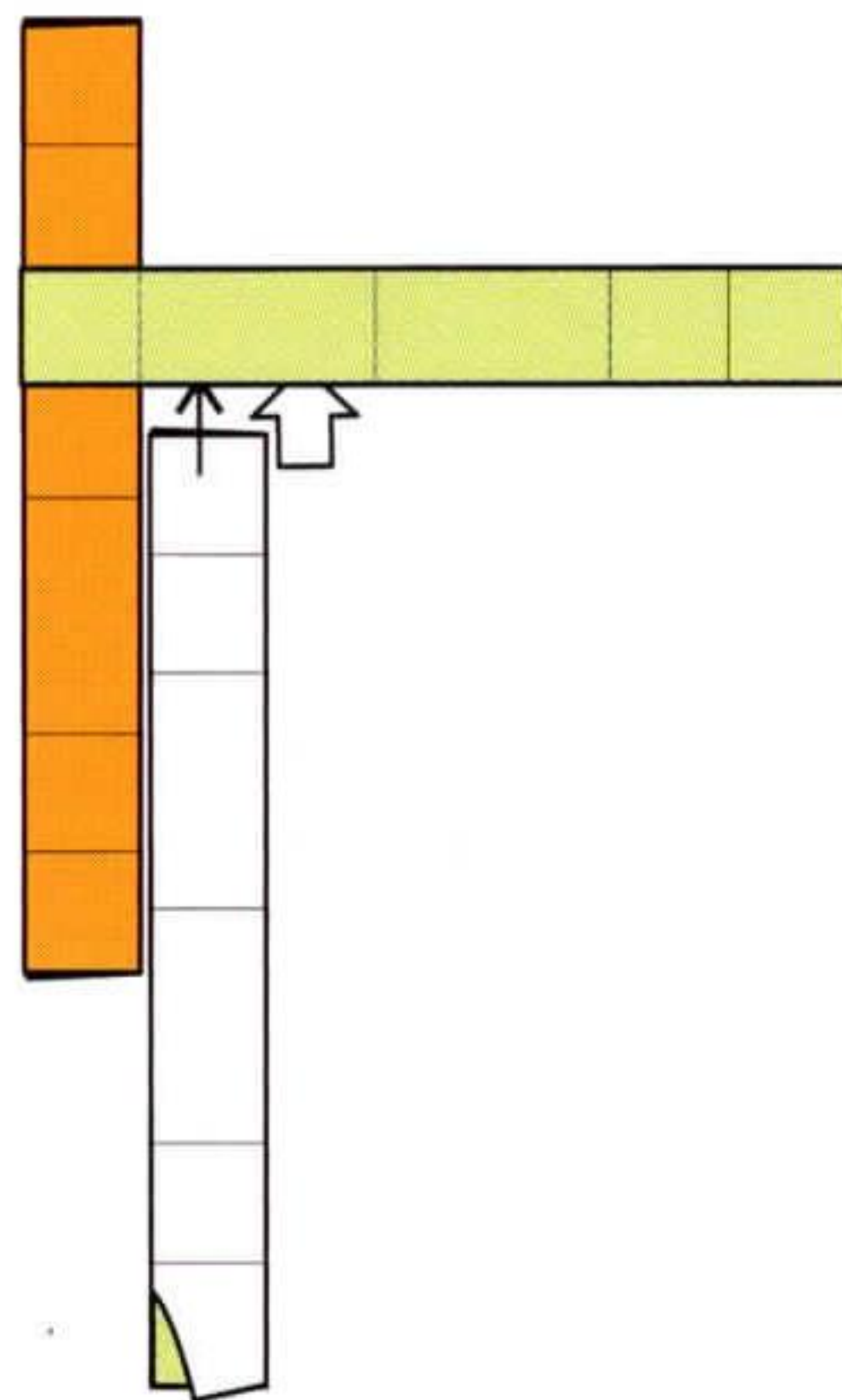

11 Add a third unit and insert it into the second unit.

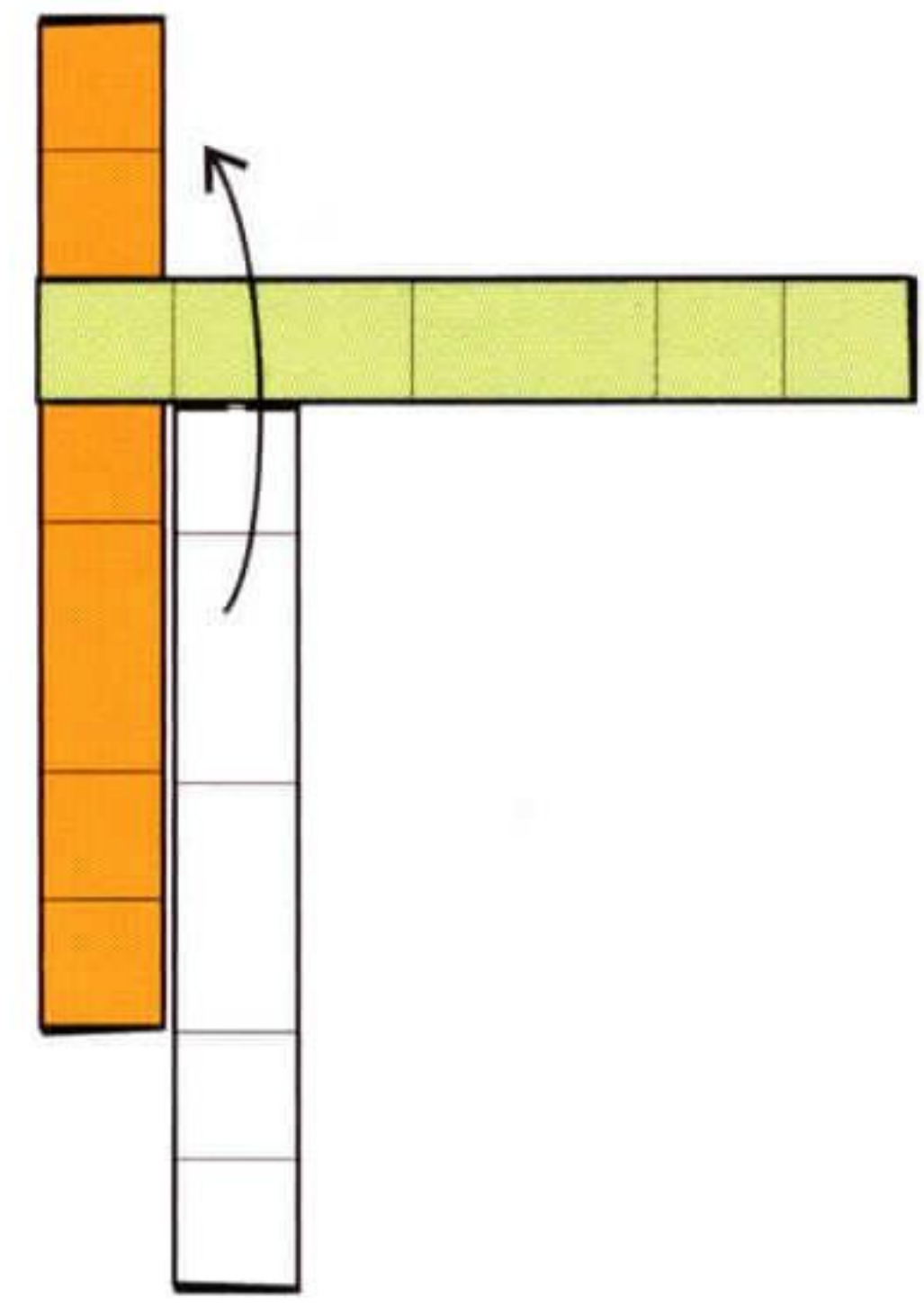

12 Fold the third unit up.

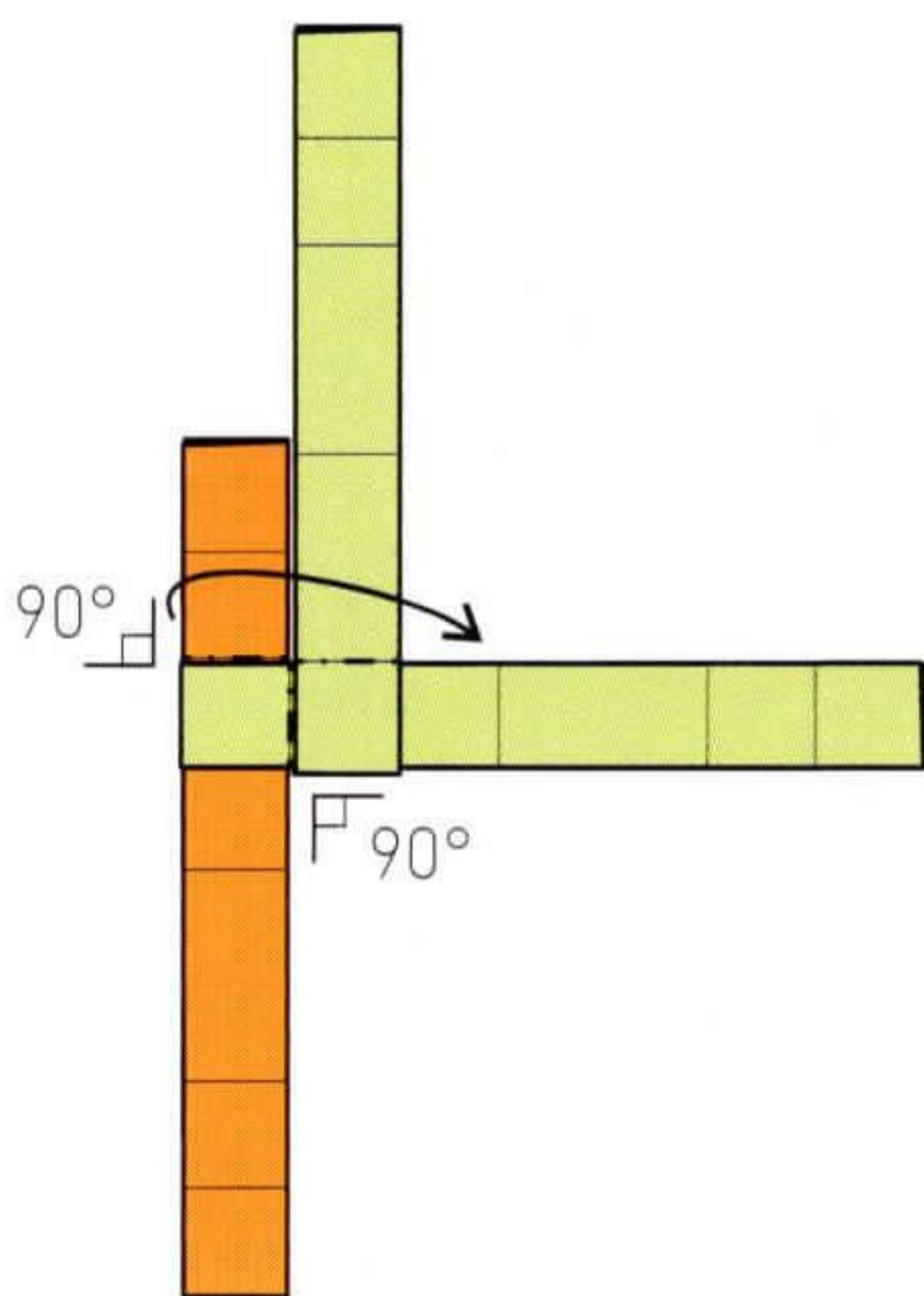

13 Fold the units perpendicular to one other, then fold end of first unit over the edge of the third.

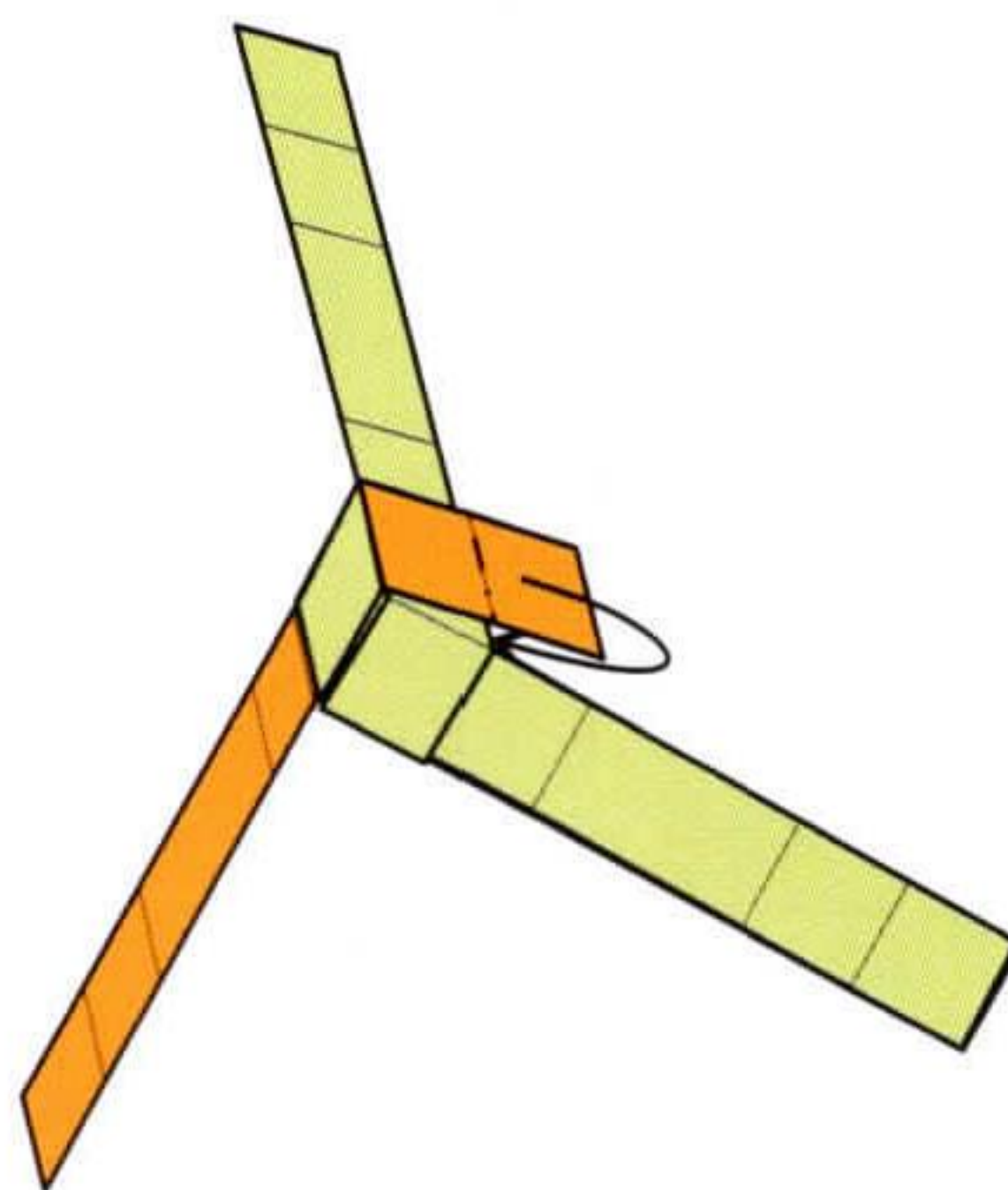

14 Fold the end of the first unit over and tuck the end between the layers of the third unit.

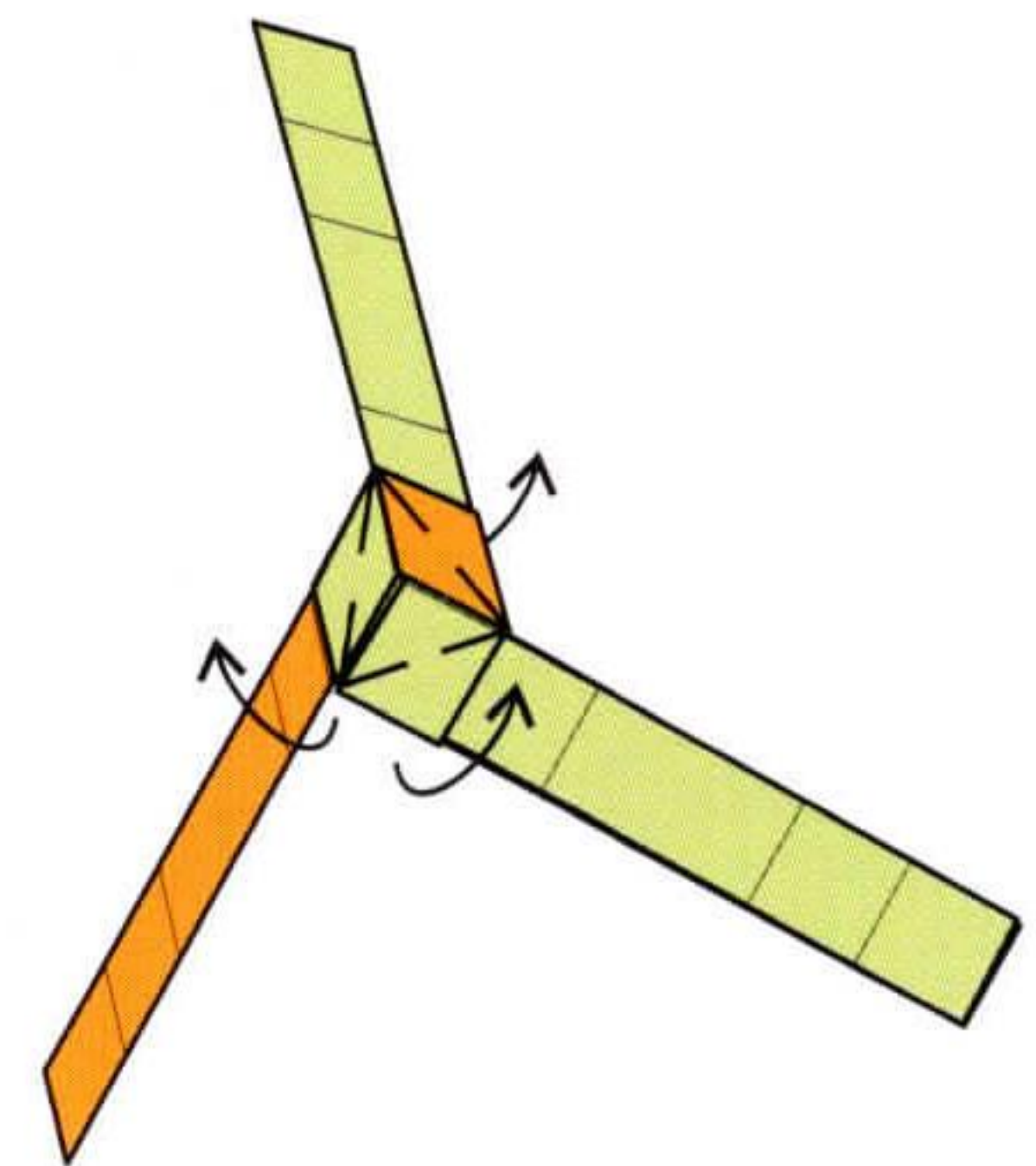

15 Make three diagonal creases and fold up each of the units.

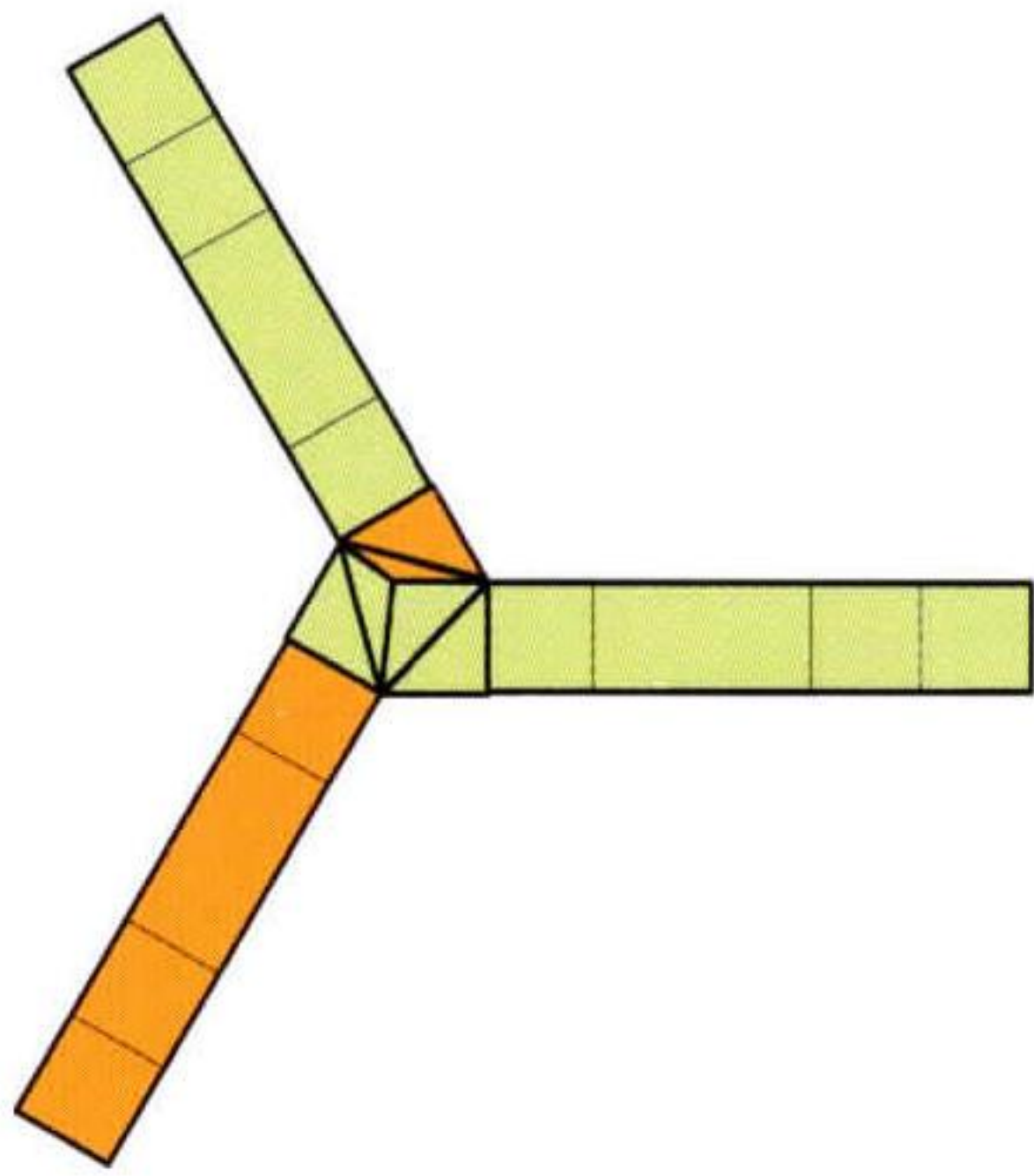

16 Three units are now assembled.

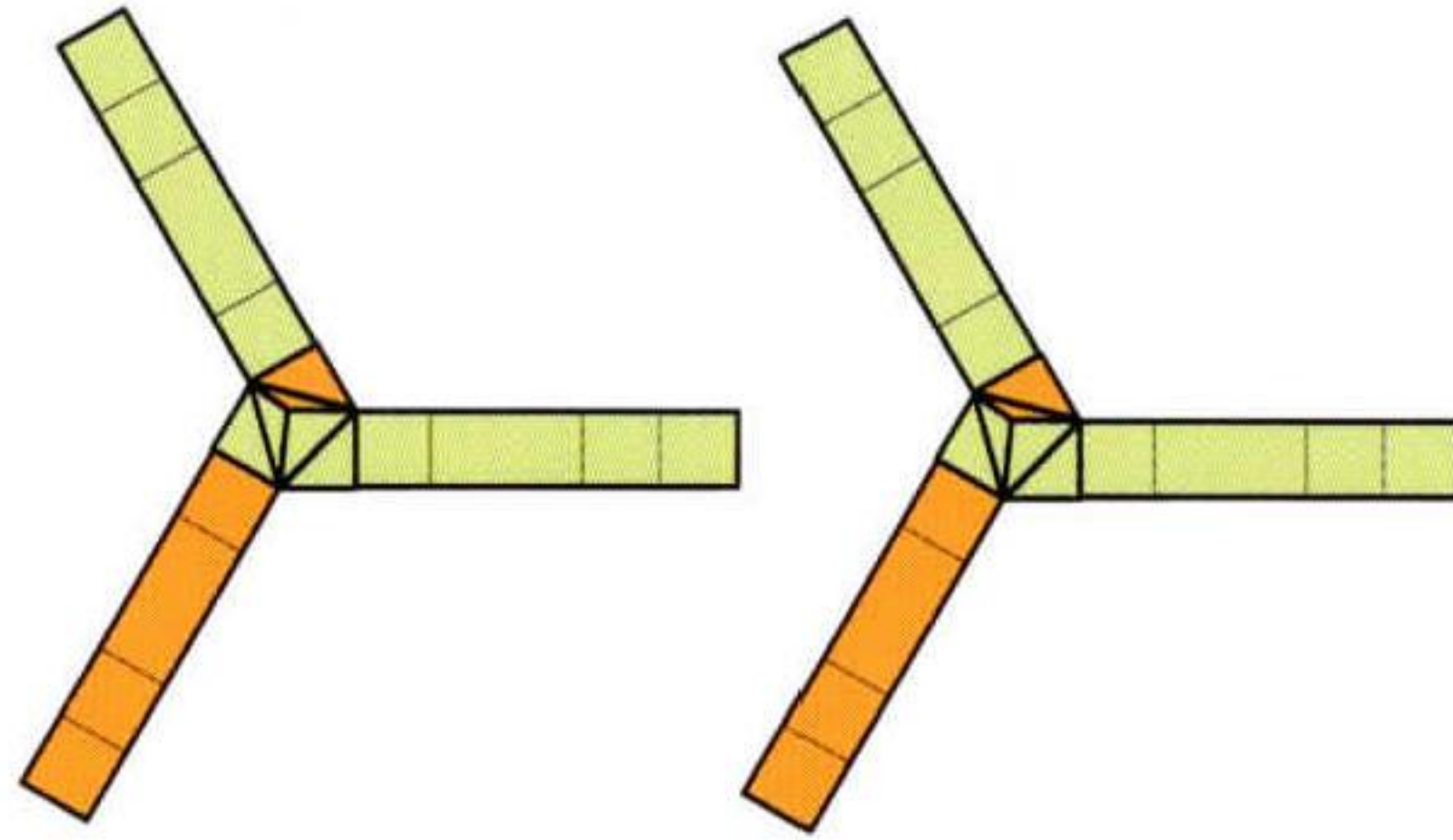

17 Repeat the assembly on three more units.

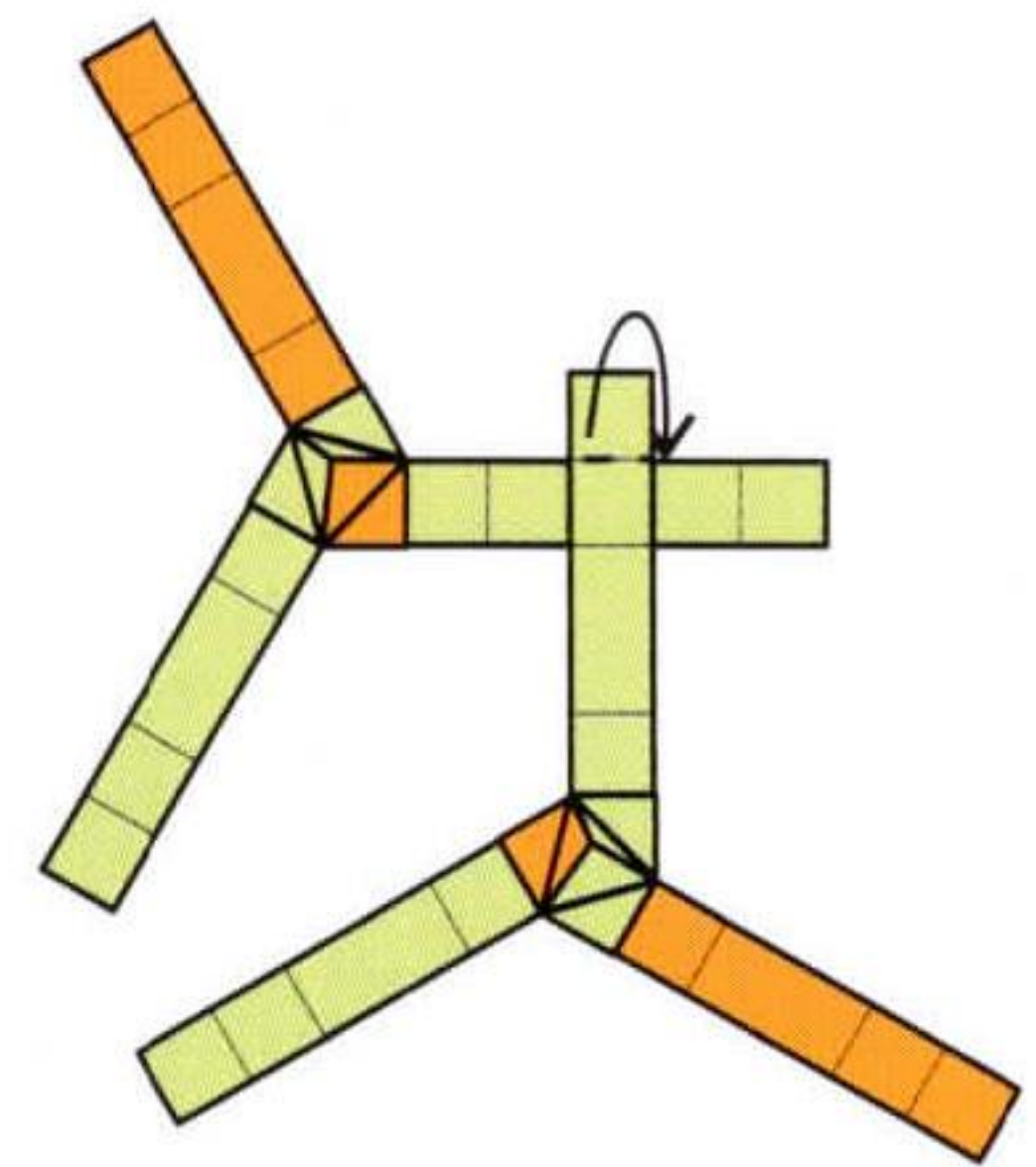

18 Place one assembly over the other and tuck the end of the tab behind, and between, the layers of the lower assembly.

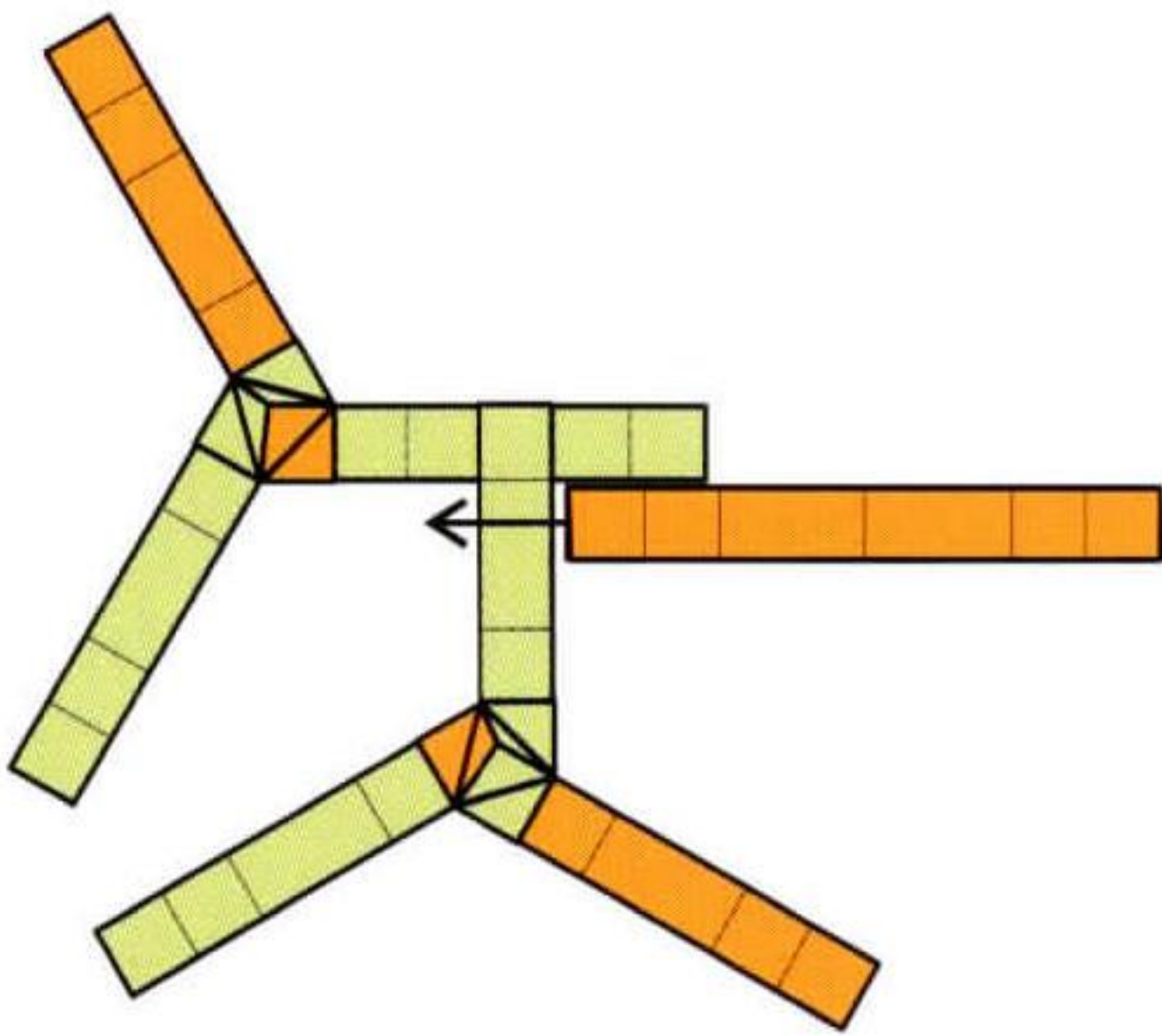

19 Add a new unit, as shown.

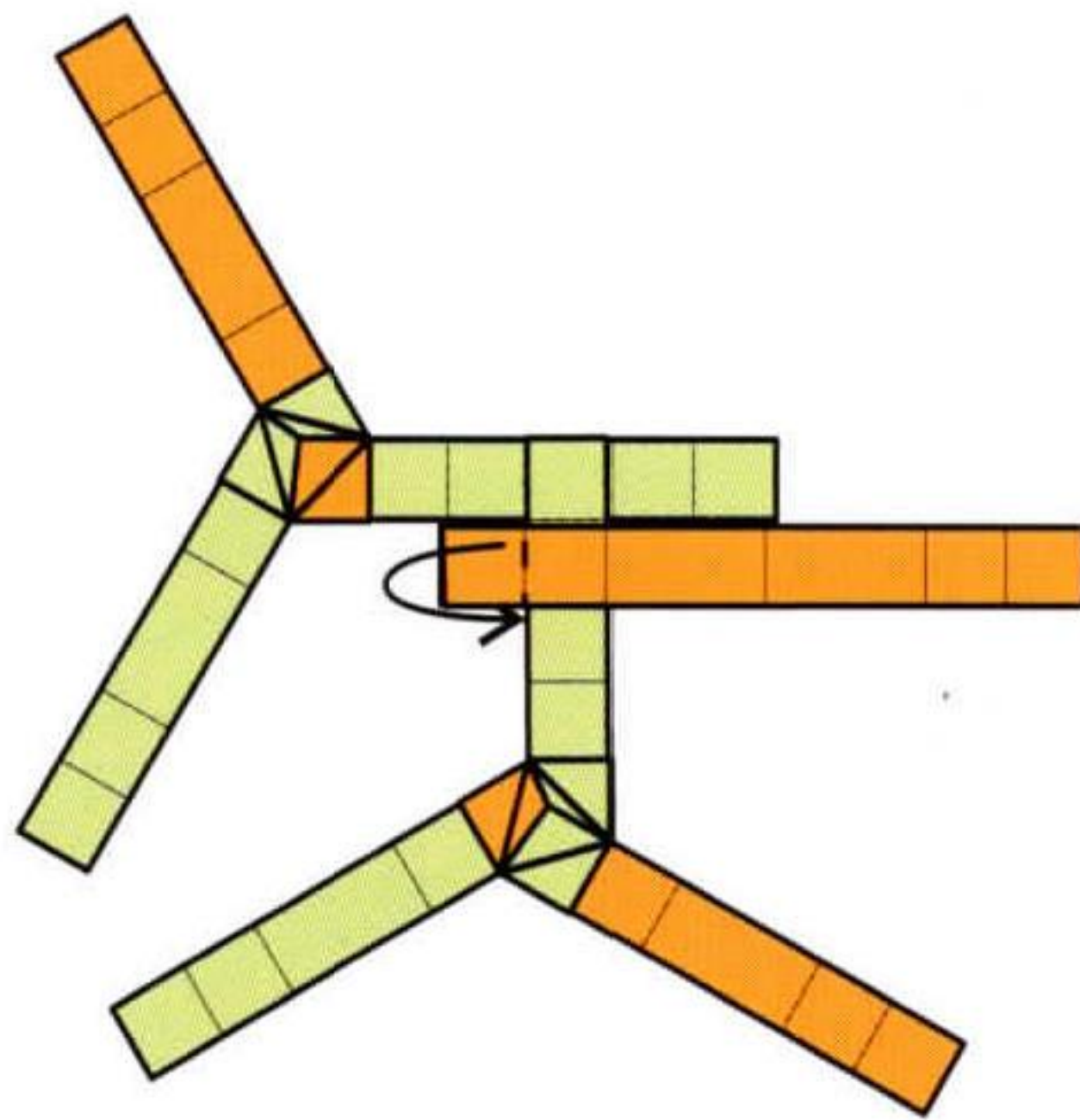

20 Fold the end of the unit behind and between the layers of the assembly beneath.

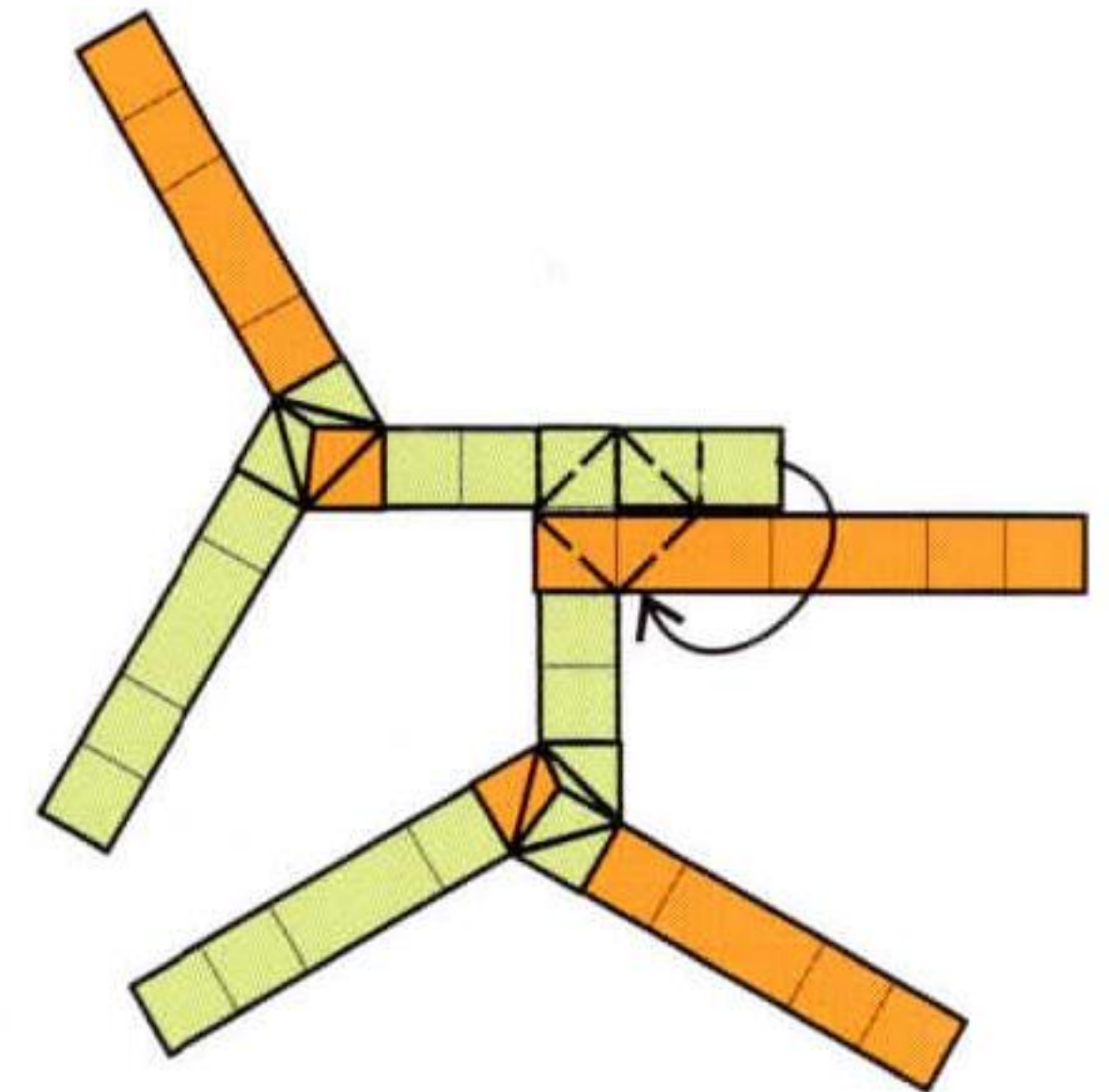

21 Fold the tip of the assembly over and tuck it into the adjacent unit. This repeats the assembly process steps 13 to 15.

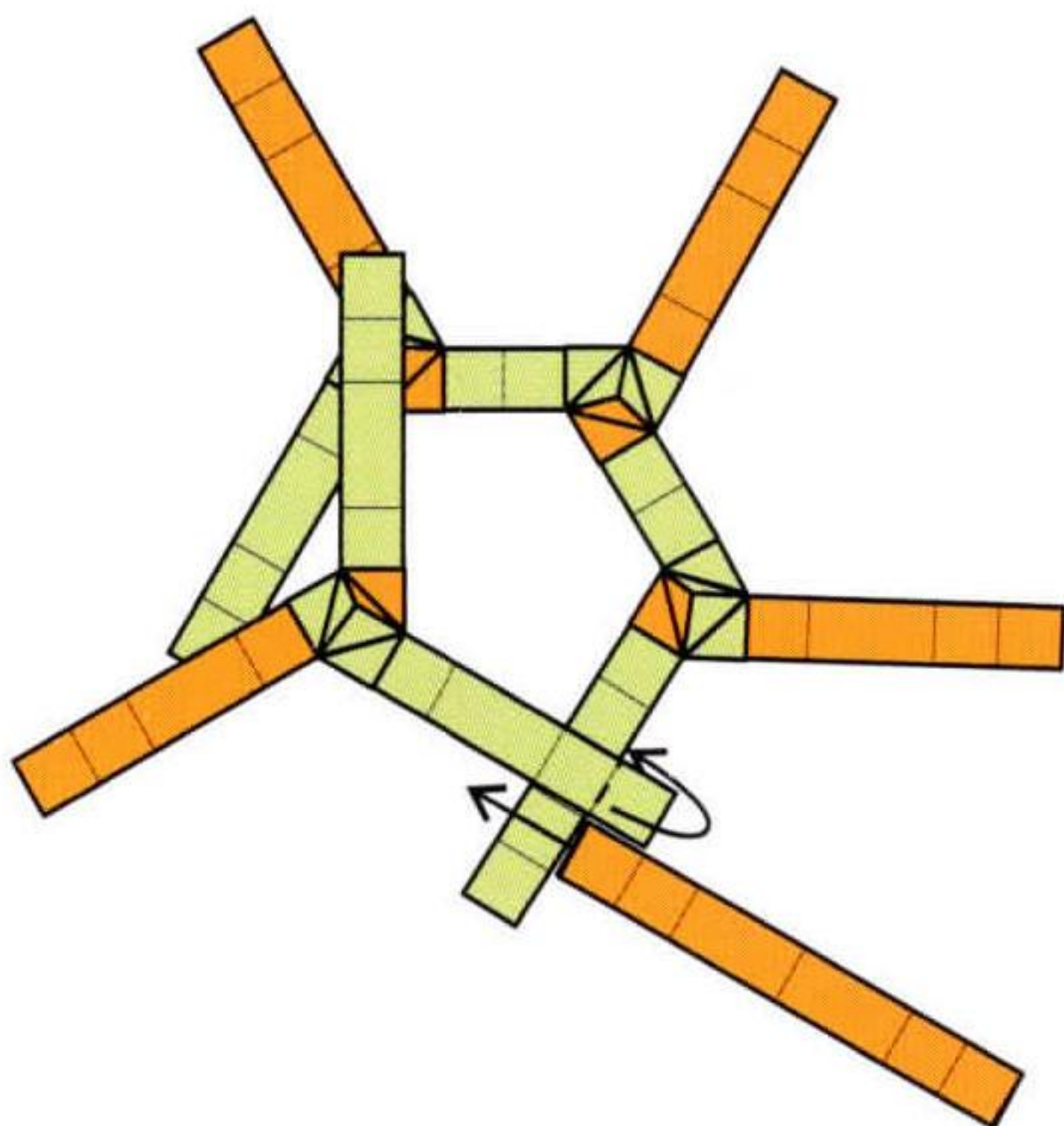

22 Add another assembly and an additional unit to connect all of the units together.

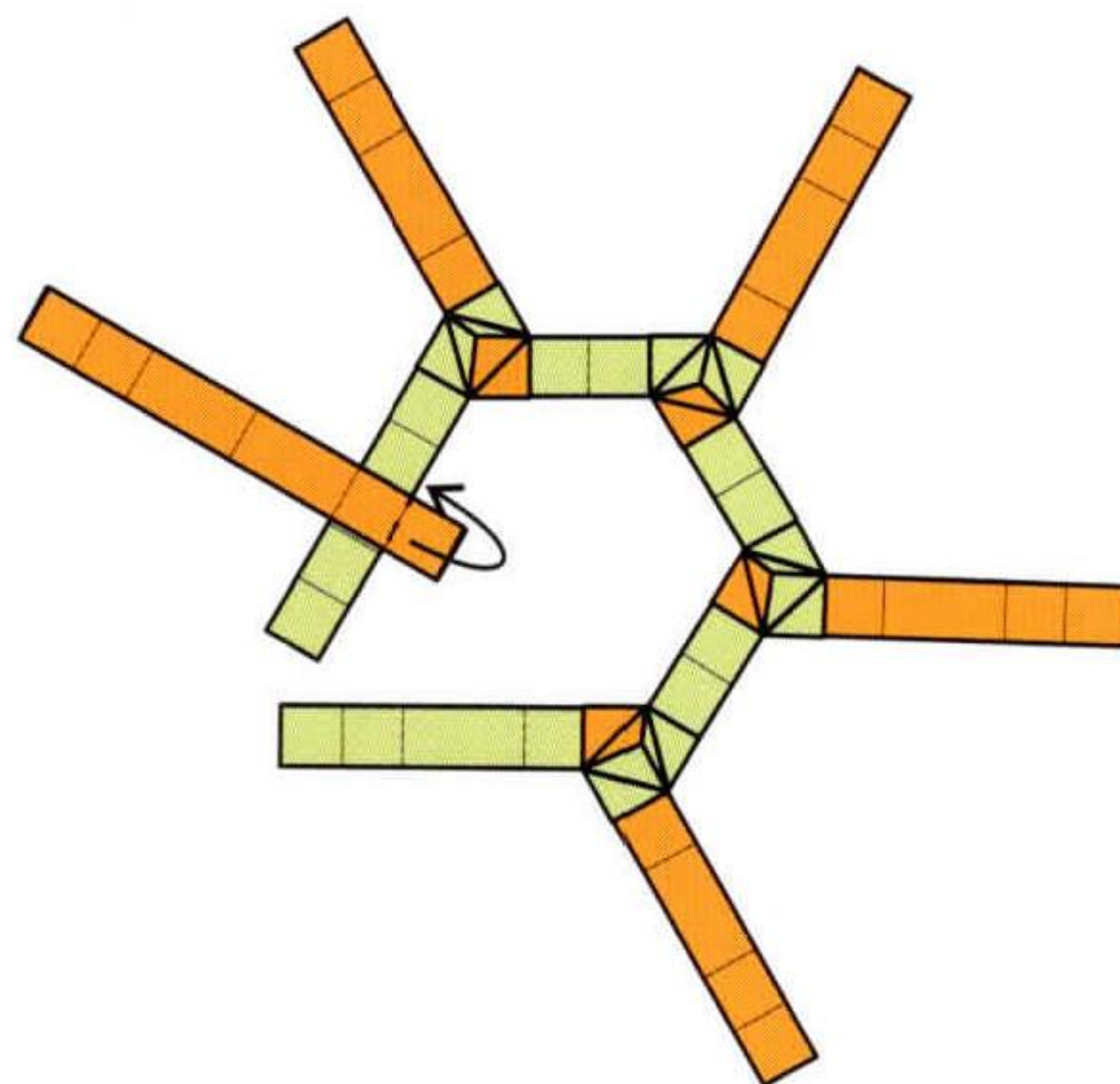

23 Add another unit to complete the ten-unit assembly.

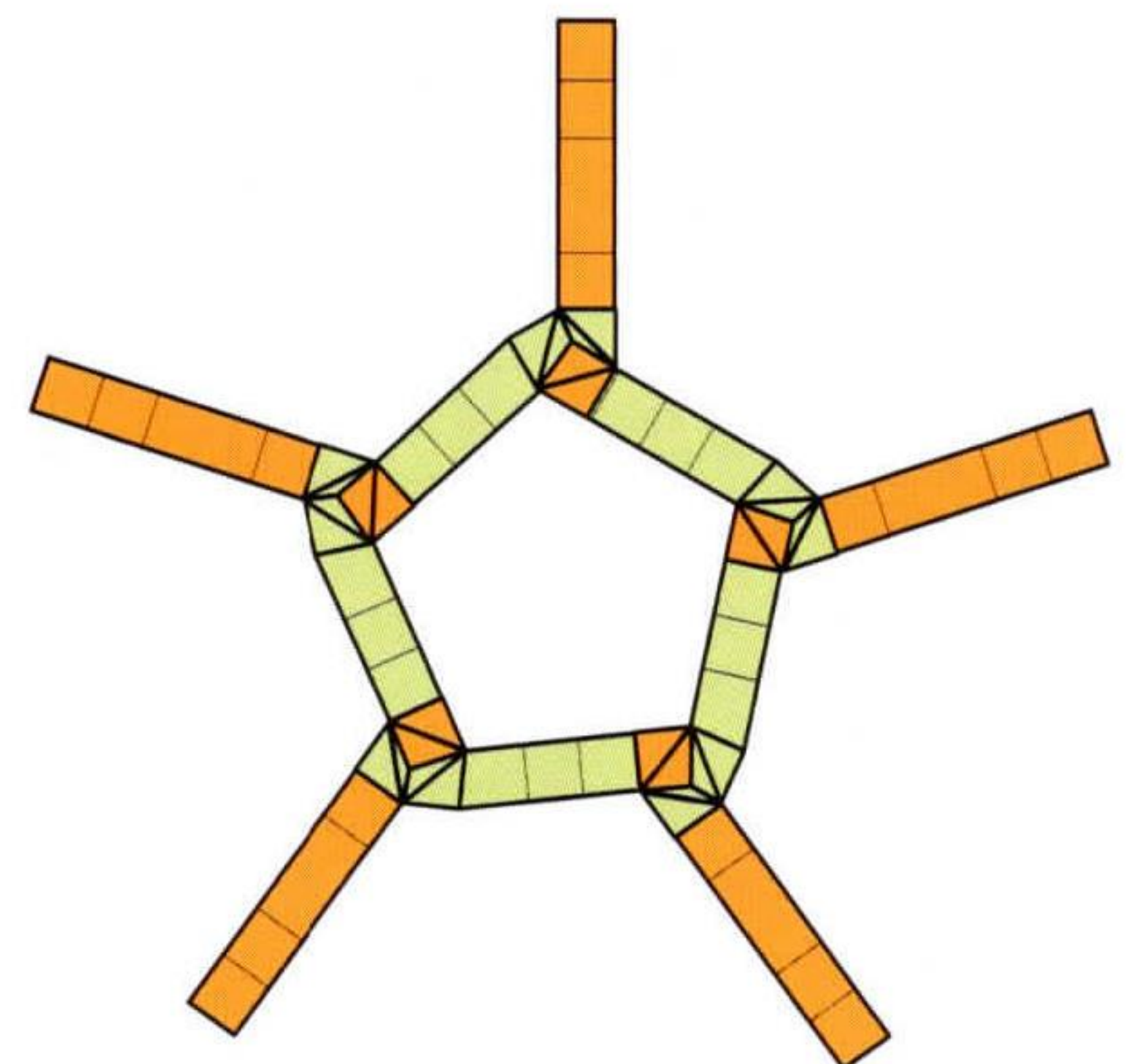

24 Ten-unit assembly complete.

DODECAHEDRON

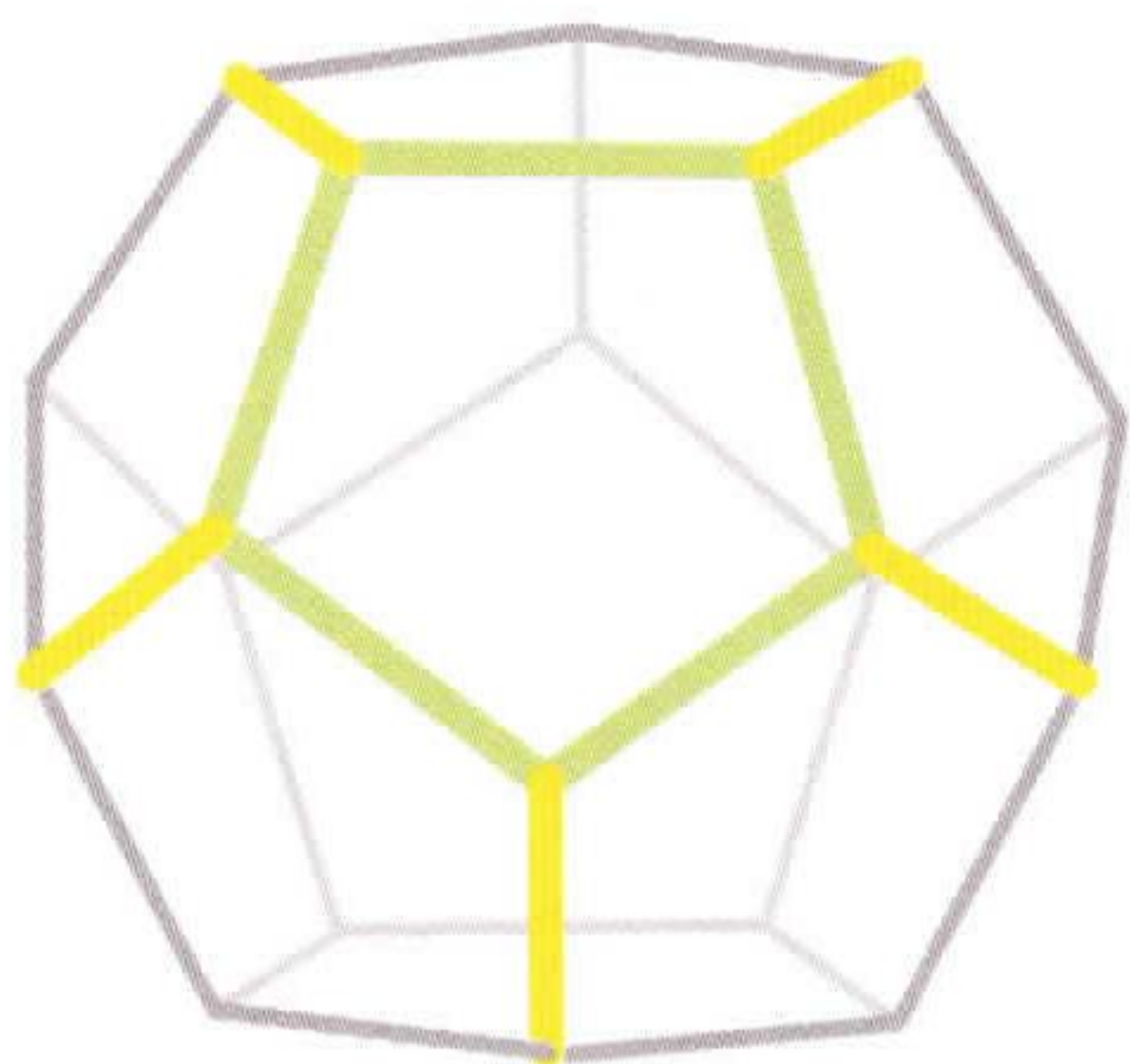

- 1 The dodecahedron is made from 30 units. Start with a 10-unit assembly and make a pentagon from a single colour.

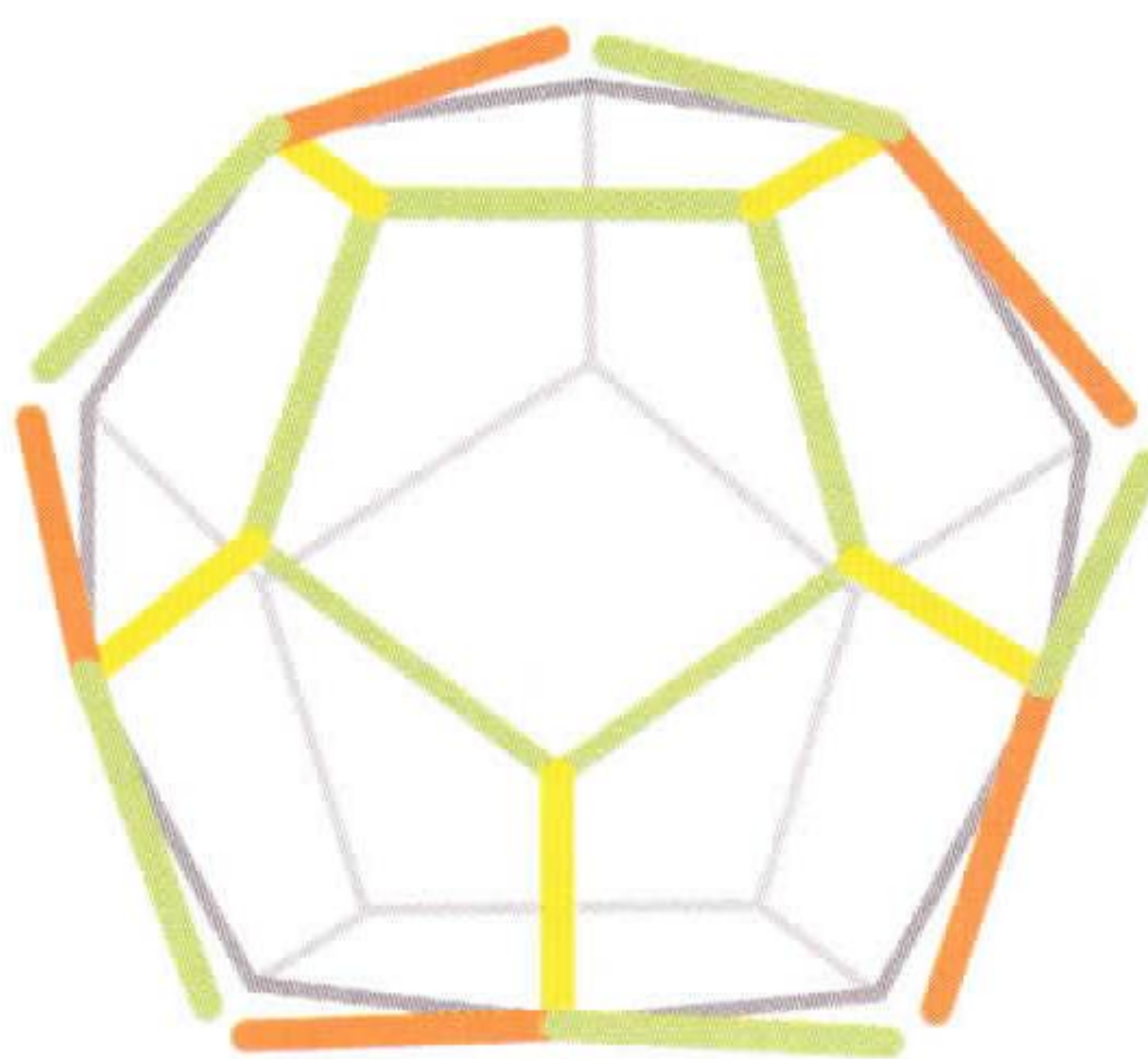

- 2 Connect two more units to each of the outlying single units.

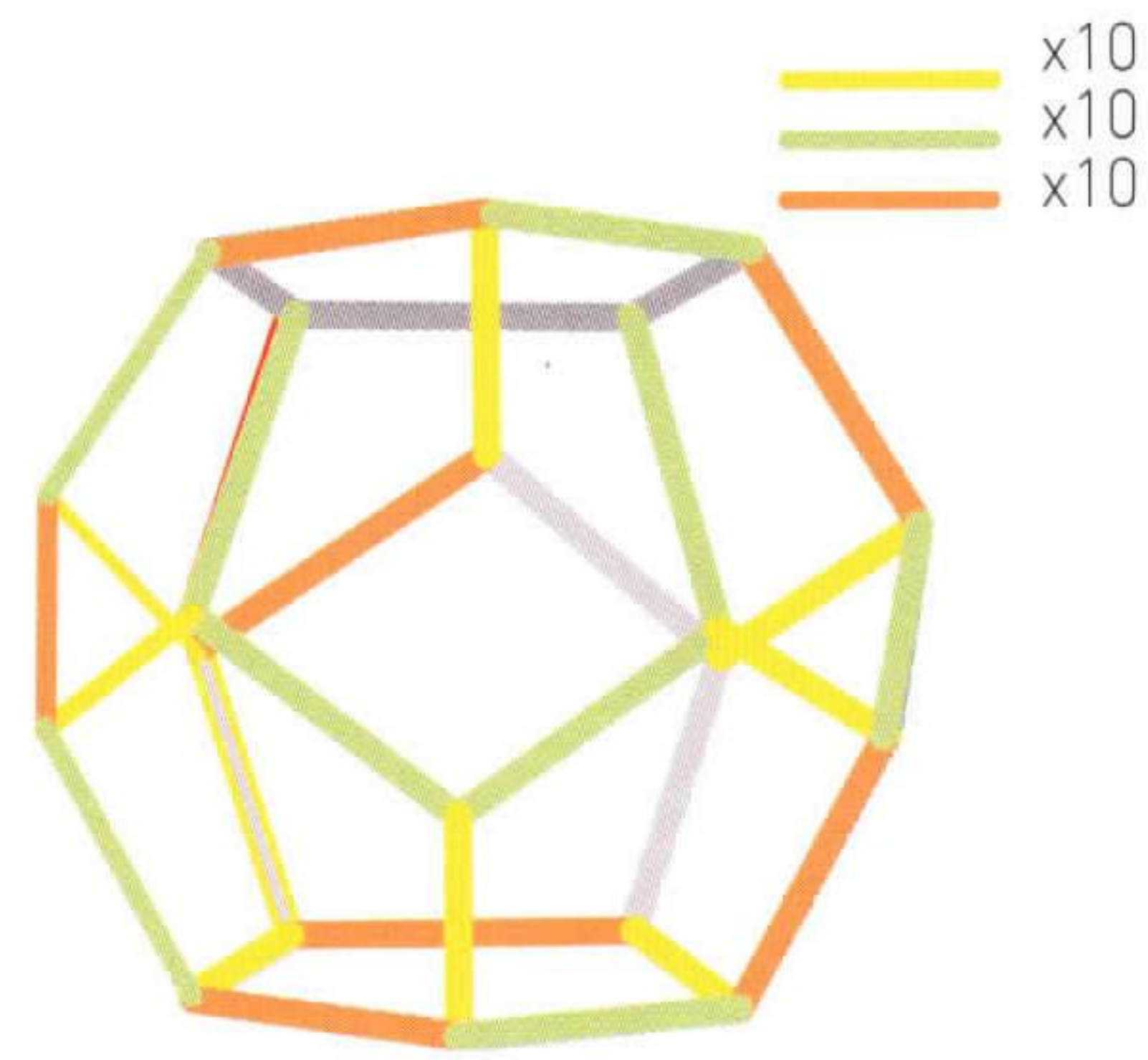

- 3 Complete the dodecahedron by adding additional units to the reverse of the model.

TRUNCATED ICOSAHEDRON

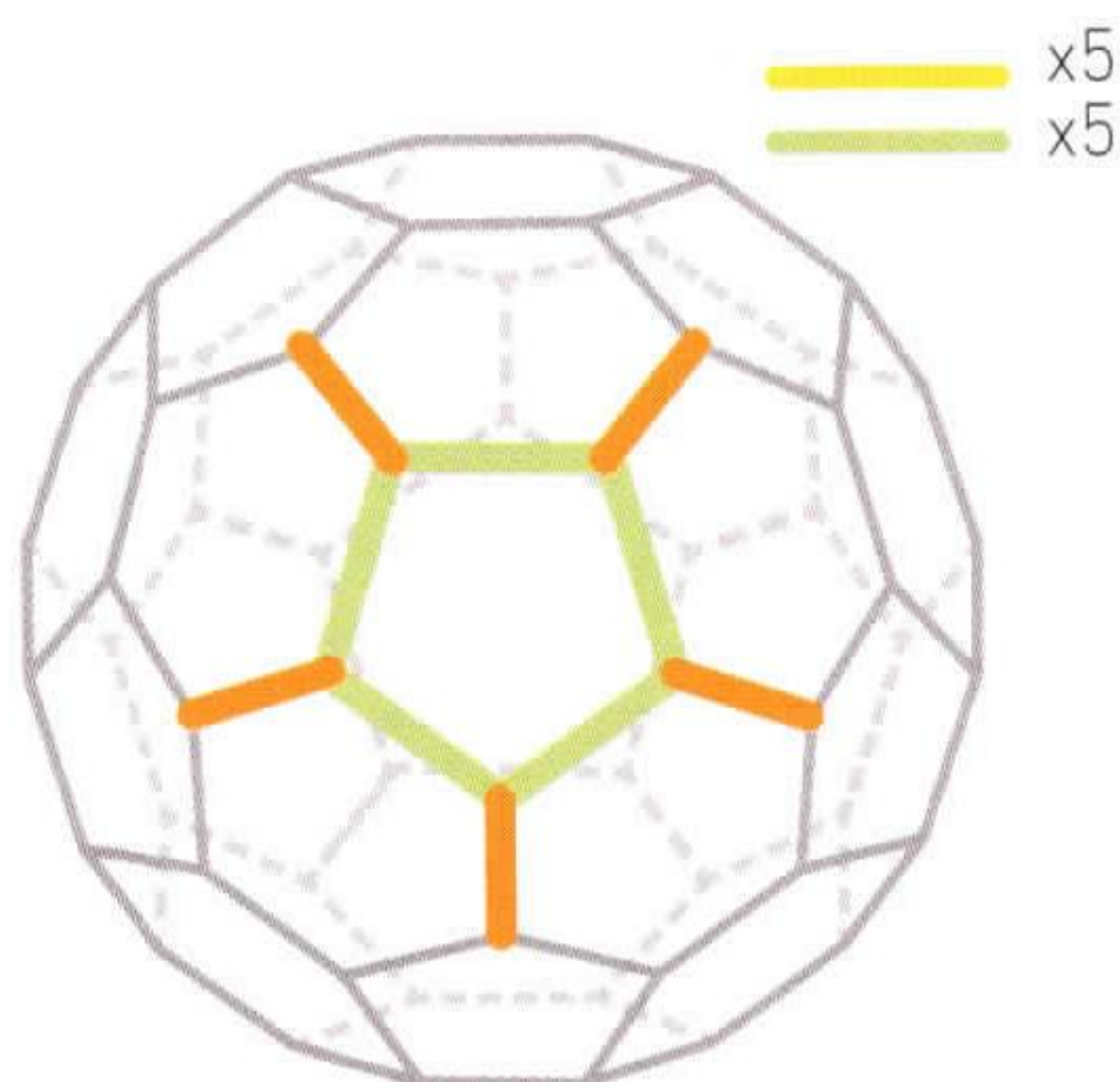

- 1 The truncated icosahedron can be made from 90 units. Start with a five-unit assembly.

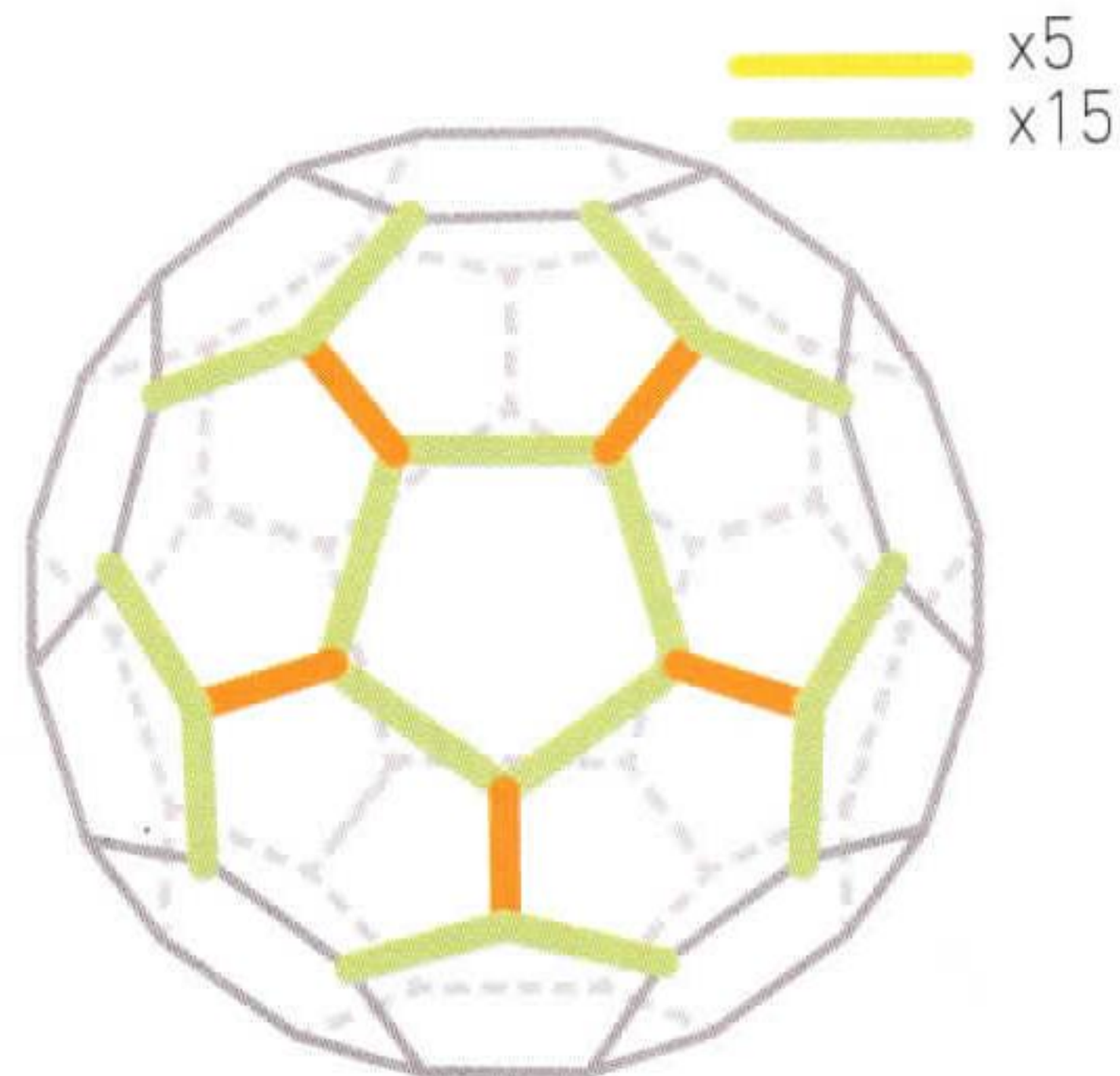

- 2 Join two additional units to each of the outlying units.

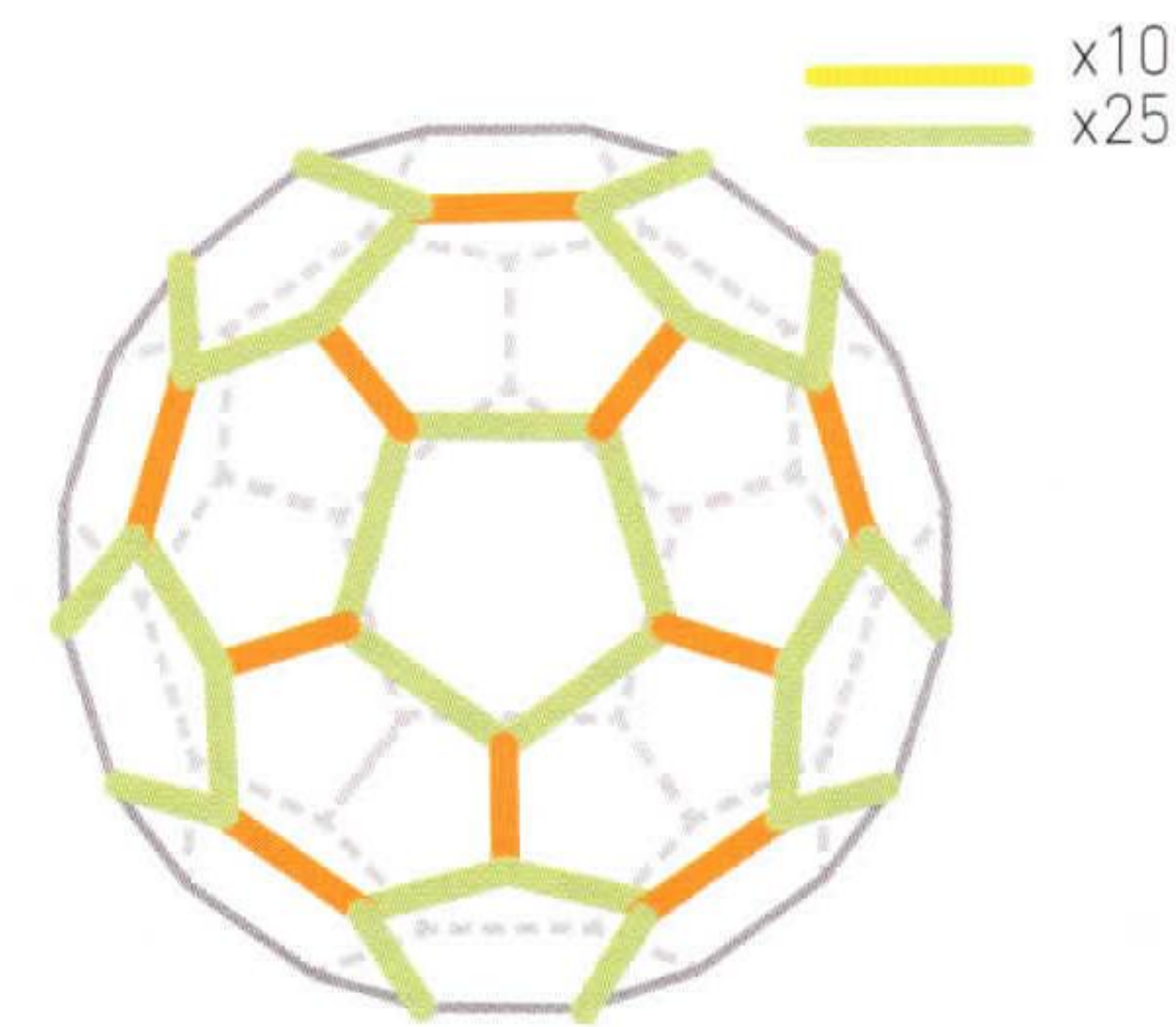

- 3 Add an additional unit to complete hexagons. At each node add two additional units using the three-unit assembly process.

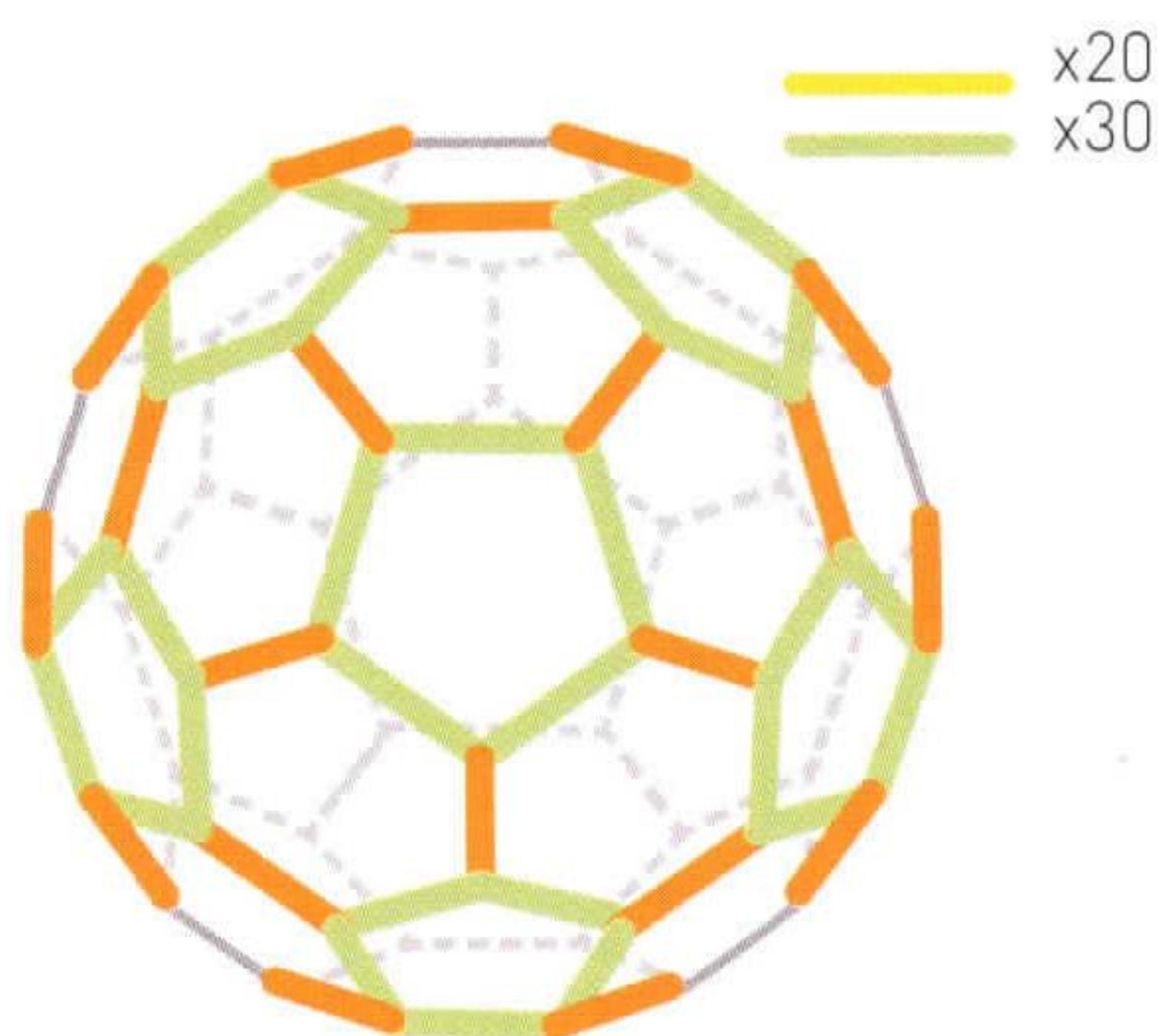

- 4 Continue adding units, the first to complete pentagons, with two additional units using the three-unit assembly process.

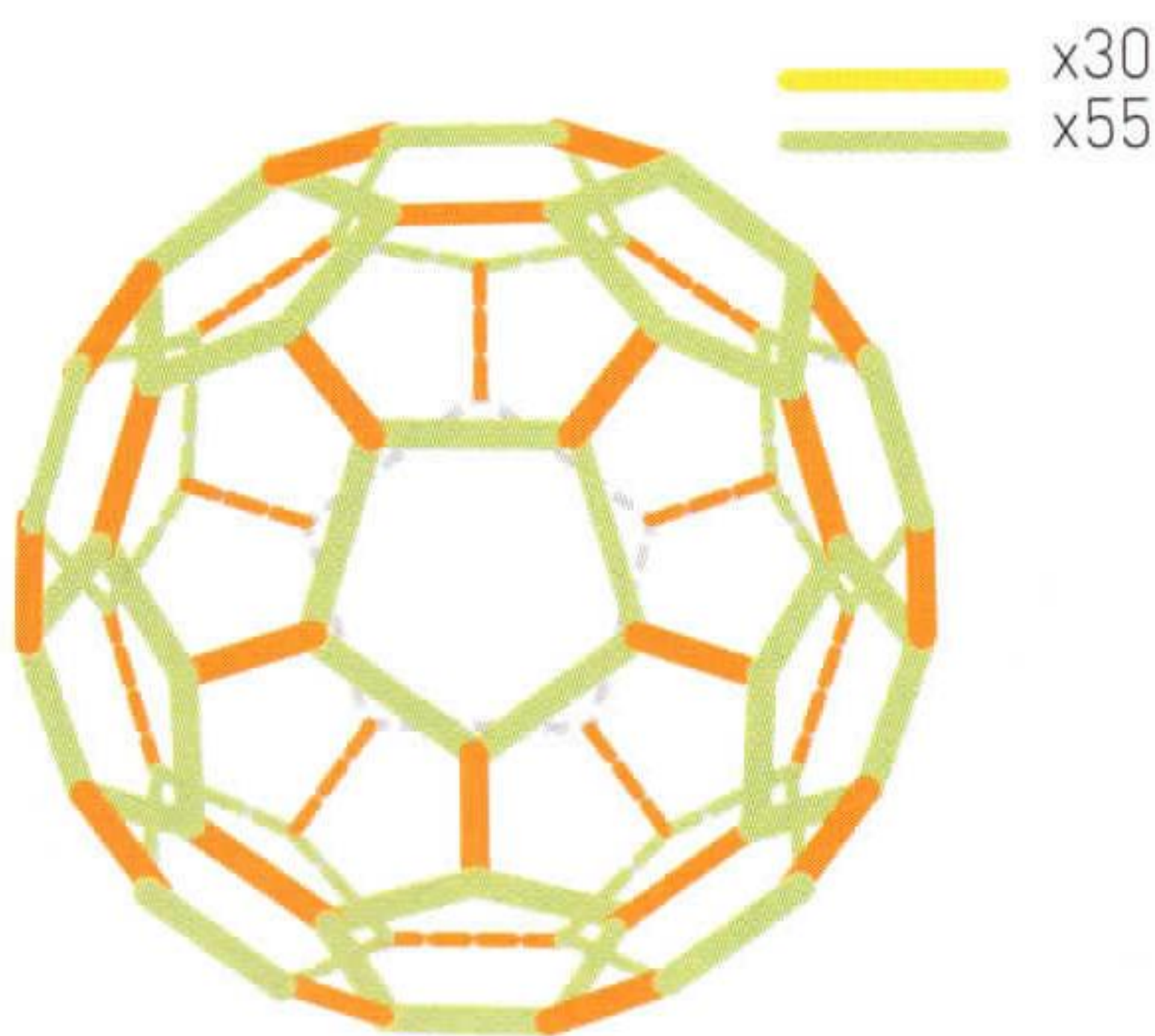

- 5 Continue adding units on the reverse, following the pentagon/hexagon assembly process.

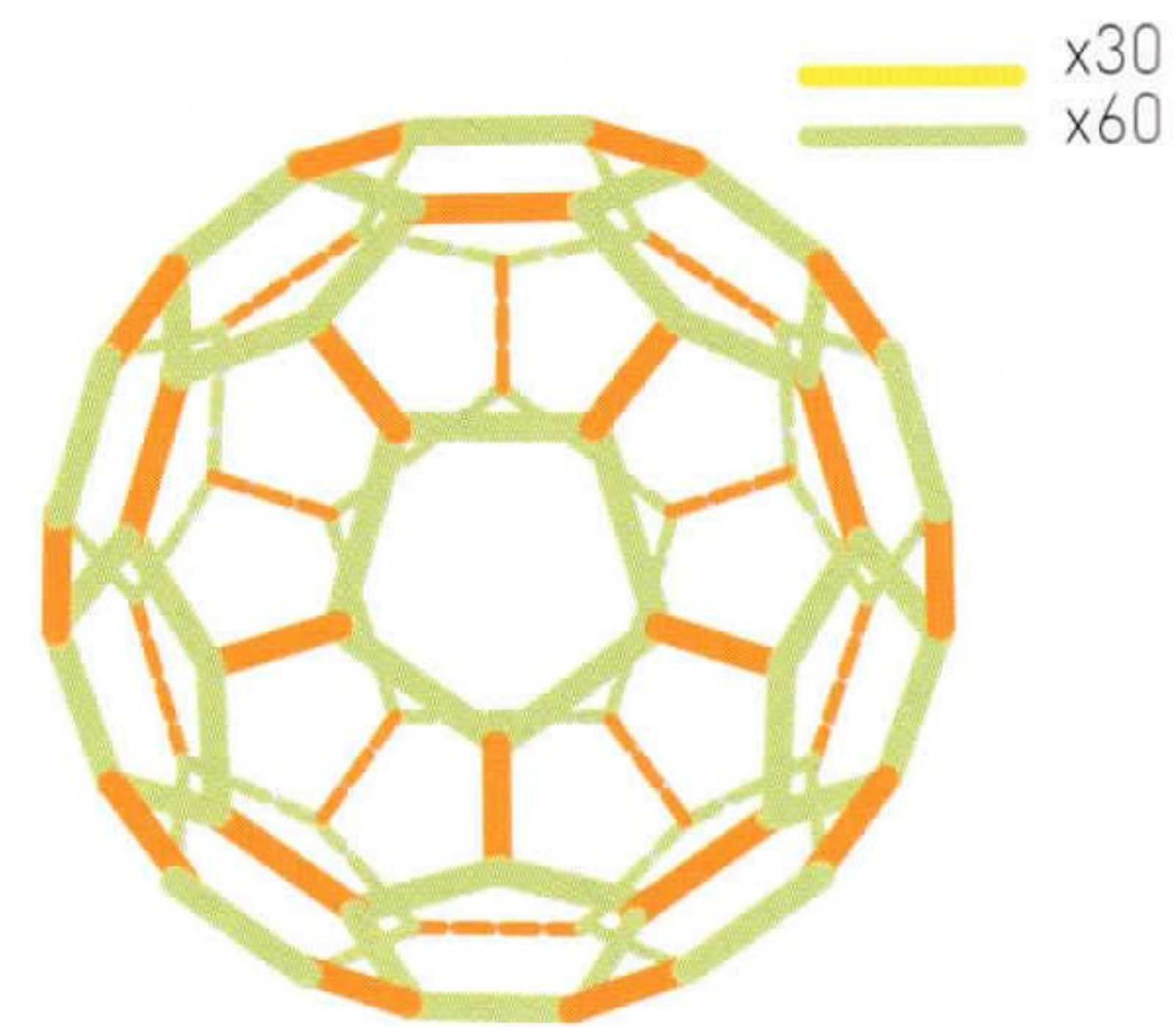

- 6 The truncated icosahedron is complete.

Starburst

**

The Starburst is assembled in a similar way to the previous projects, but the design of this unit leads to extended stellations. These instructions are for a 30-unit starburst.

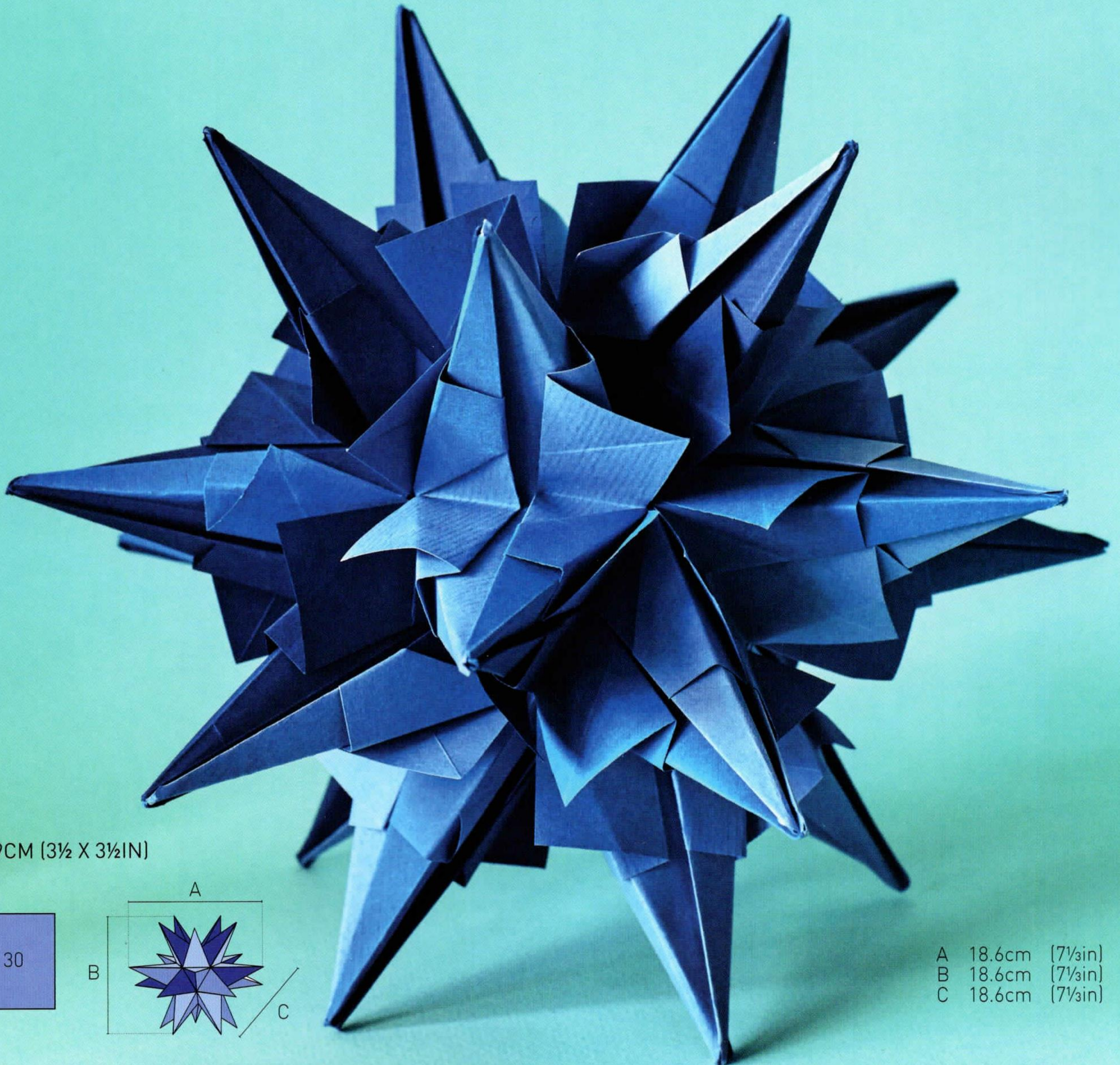

9 X 9CM (3½ X 3½IN)

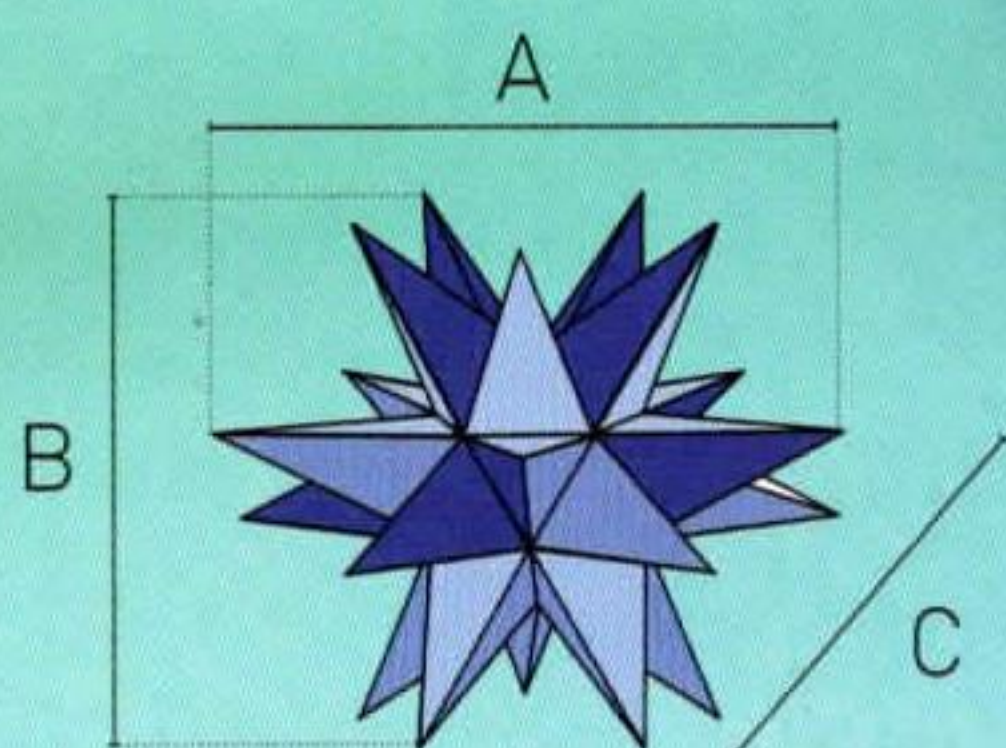
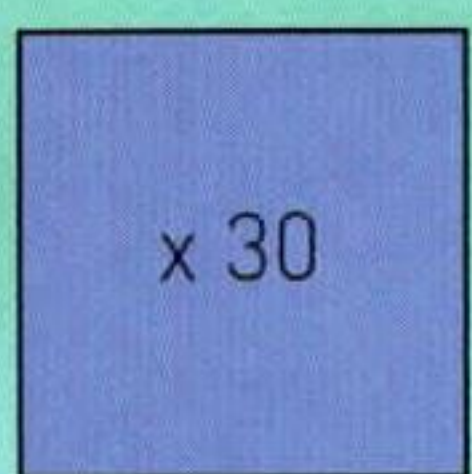

A 18.6cm (7½in)
B 18.6cm (7½in)
C 18.6cm (7½in)

THE STARBURST ASSEMBLY IS MADE FROM 30 UNITS. EACH UNIT STARTS WITH A SQUARE, COLOURED SIDE UP.

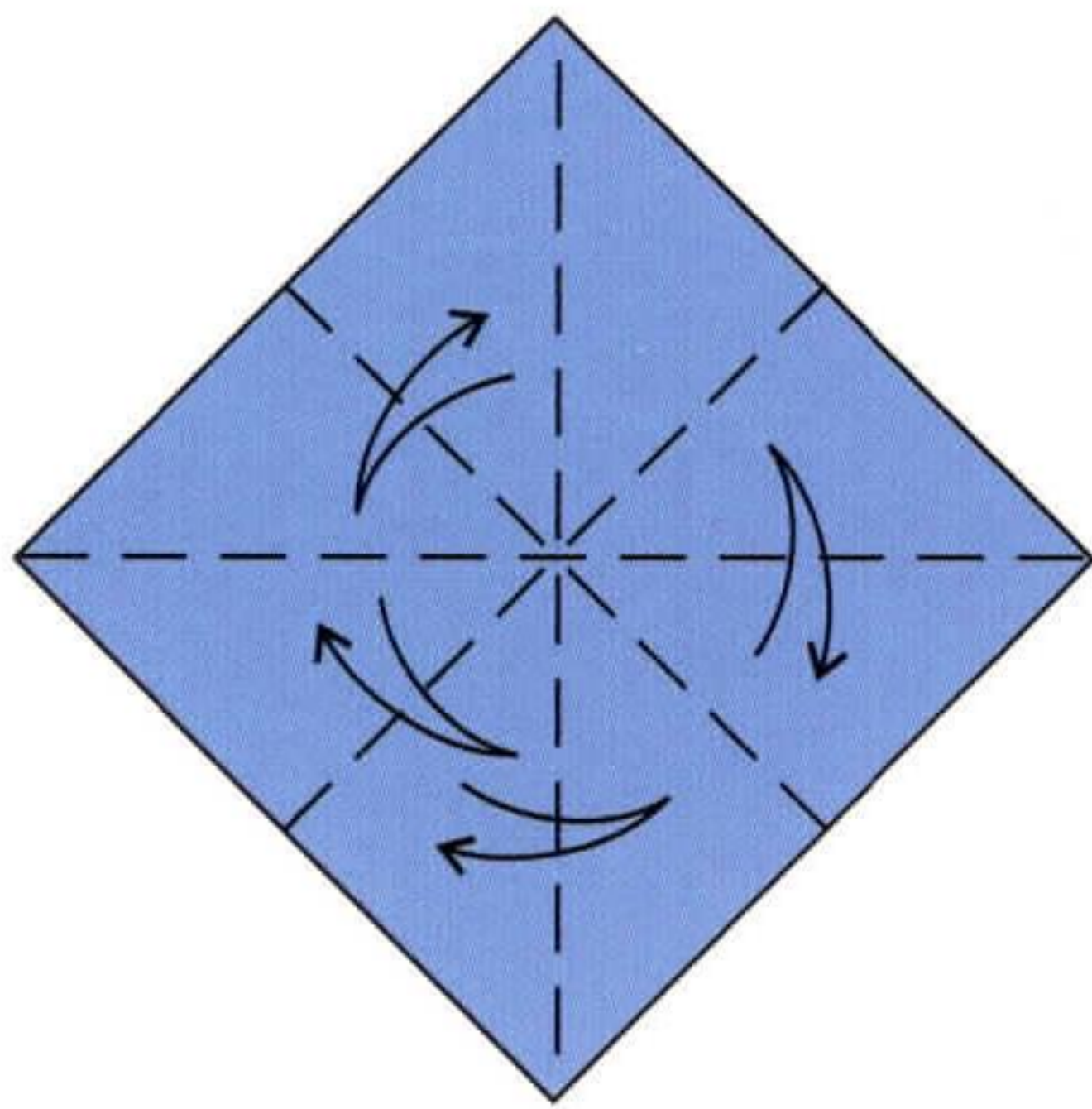

1 Fold and unfold the square in half lengthwise and diagonally along all axes.

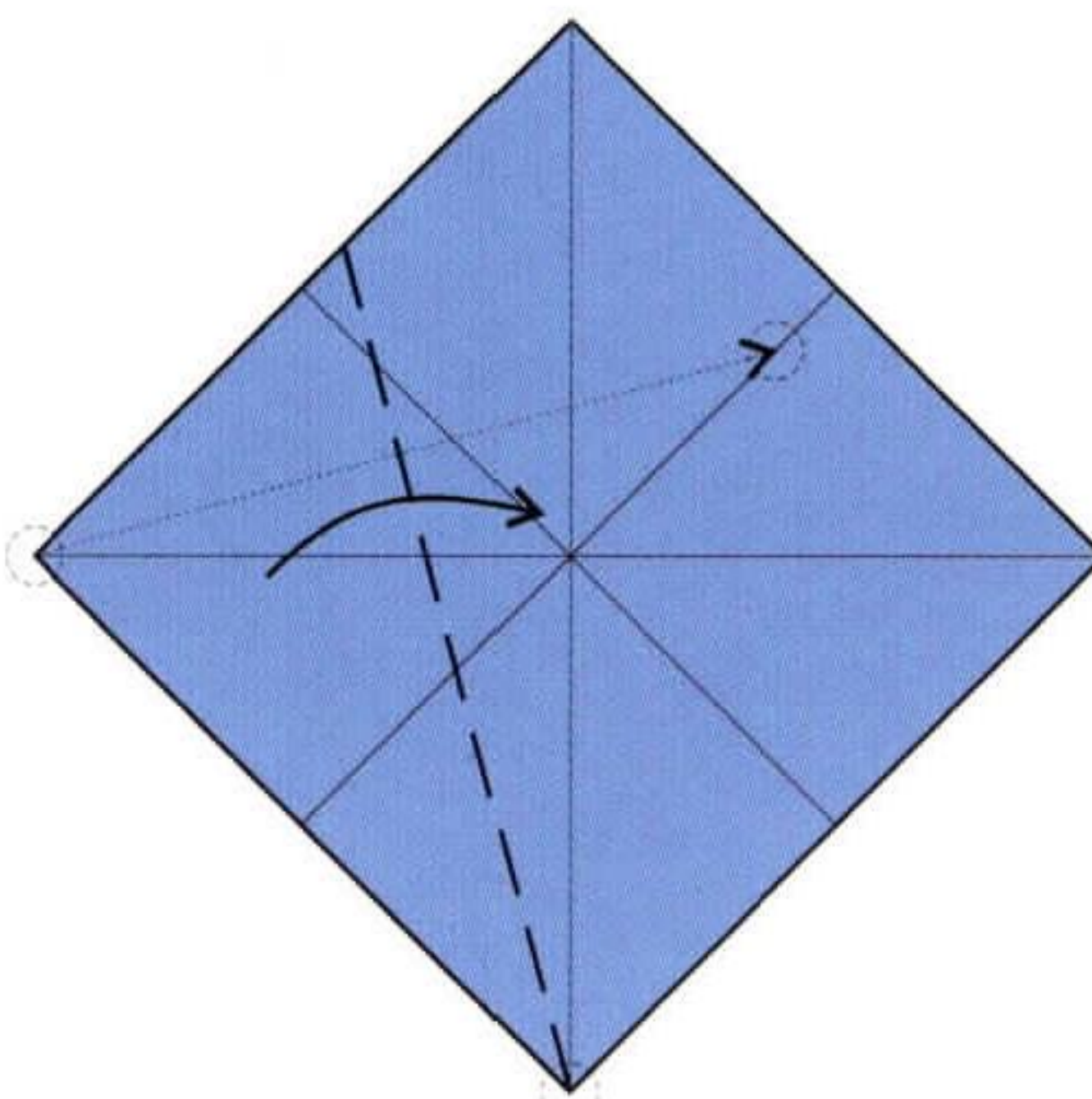

2 Fold the left corner in to touch the vertical middle crease. The fold starts from the lower corner.

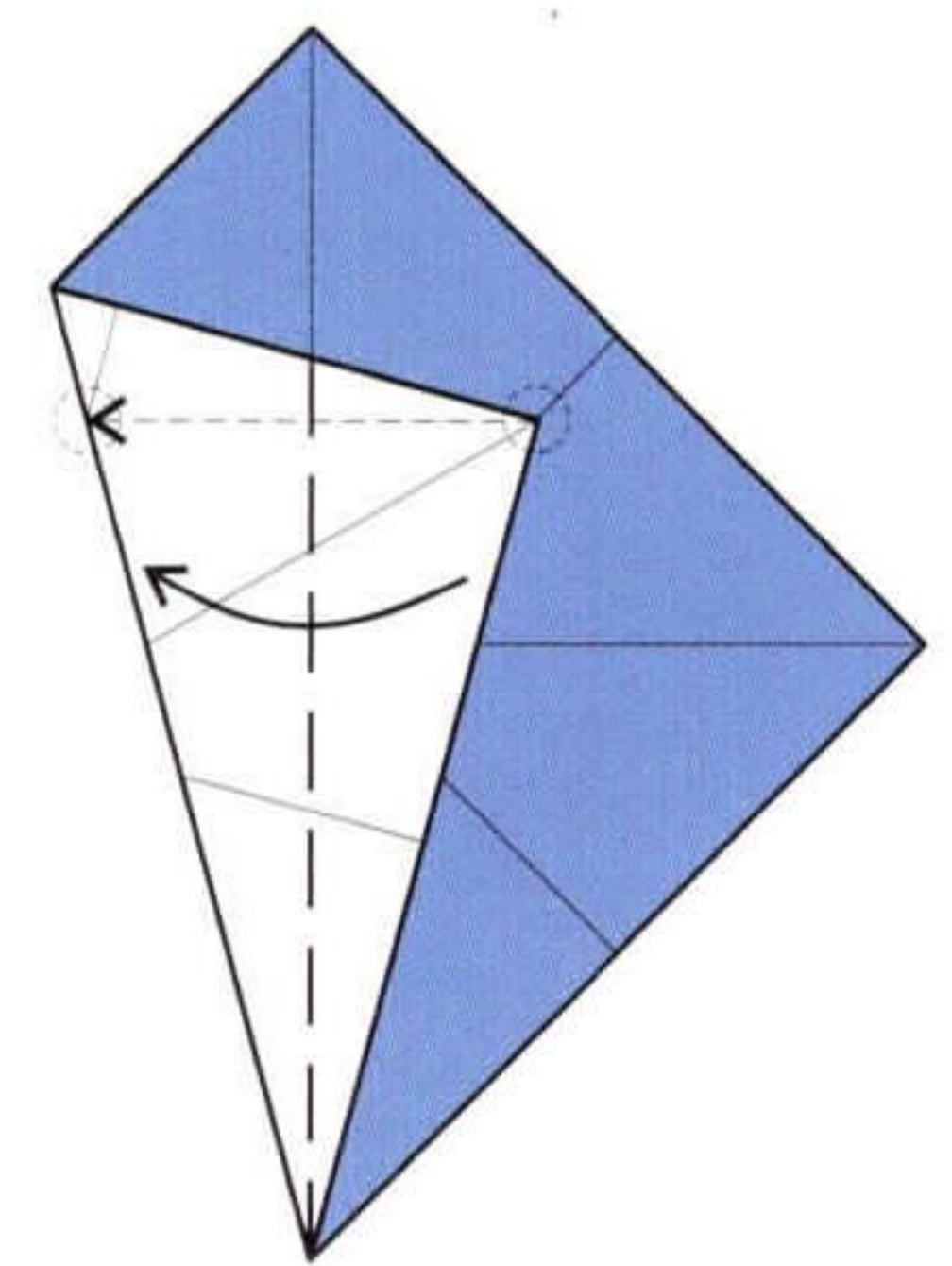

3 Fold the edge back out to the adjacent folded edge.

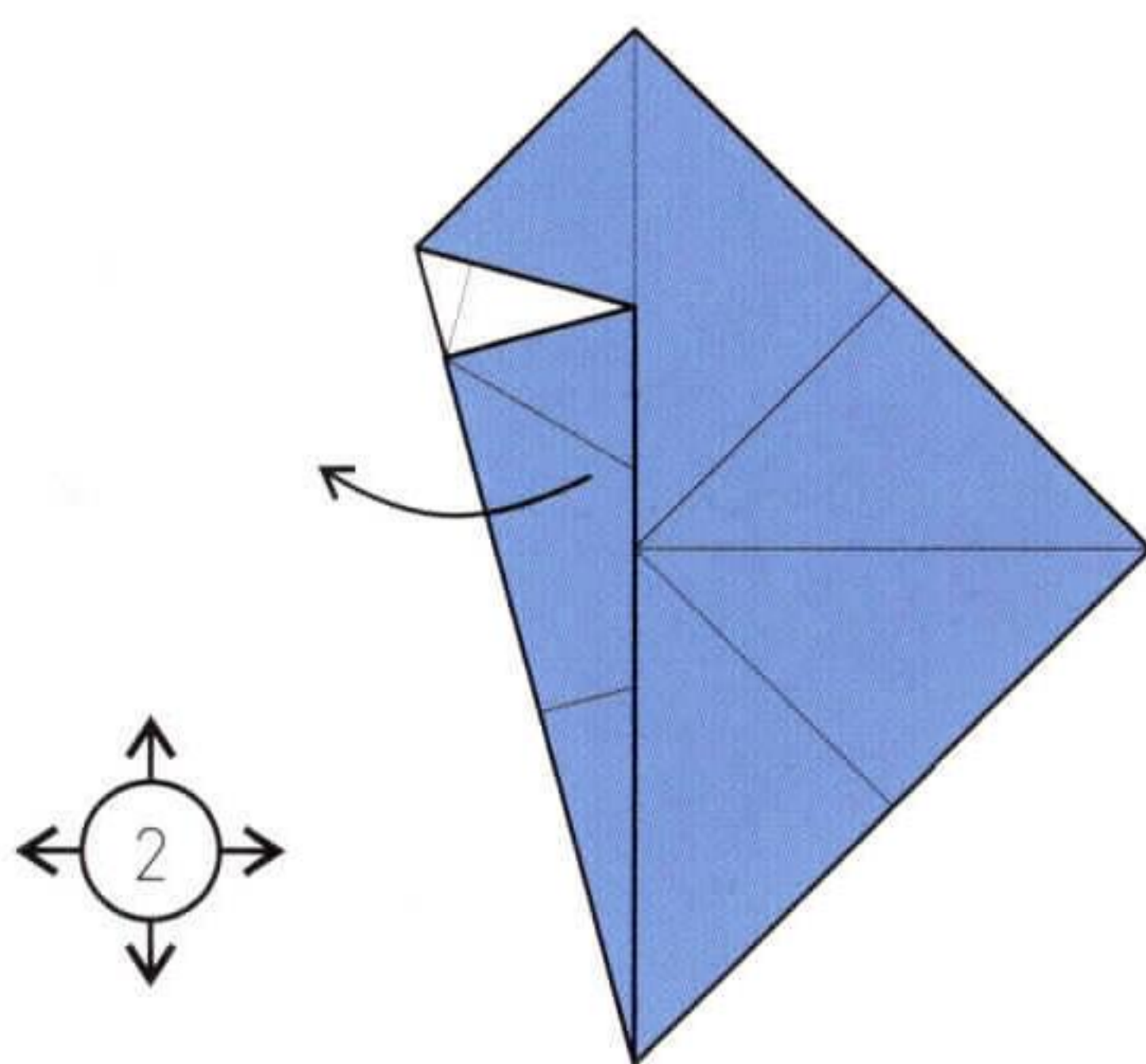

4 Unfold the model back to a square (step 2).

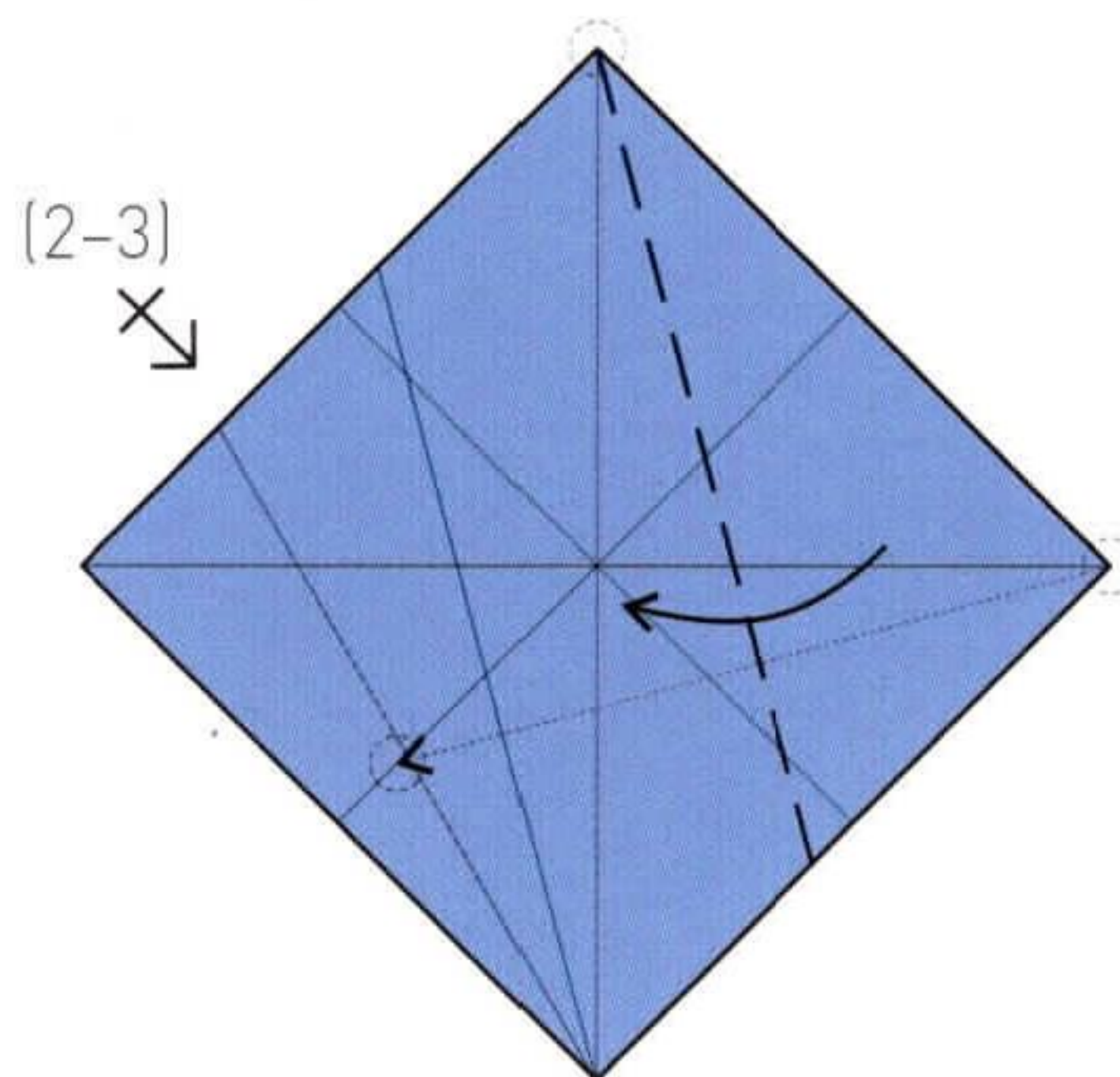

5 Fold the outer corner in to the opposite vertical crease and repeat steps 2 to 3.

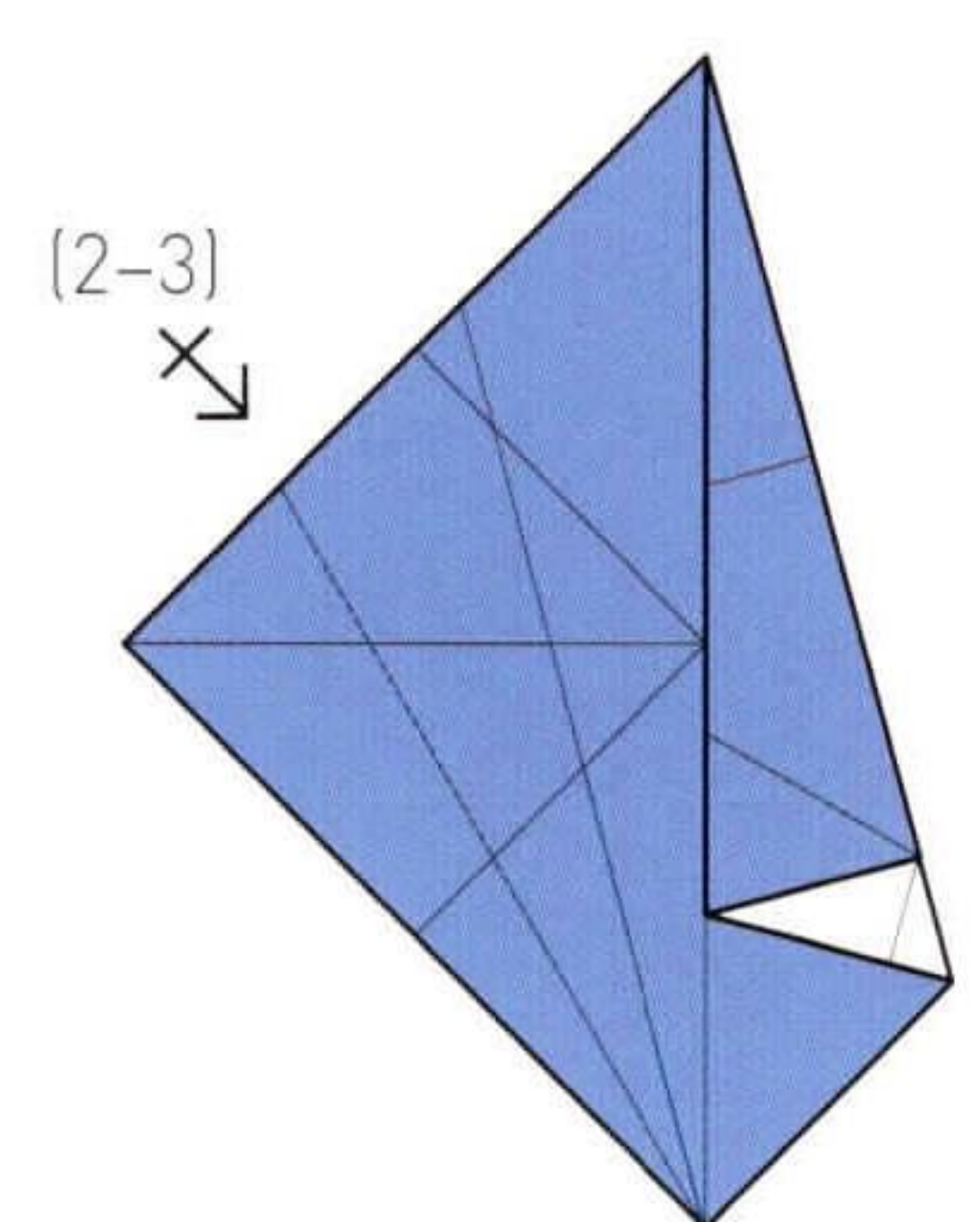

6 Repeat steps 2 to 3 on the other side.

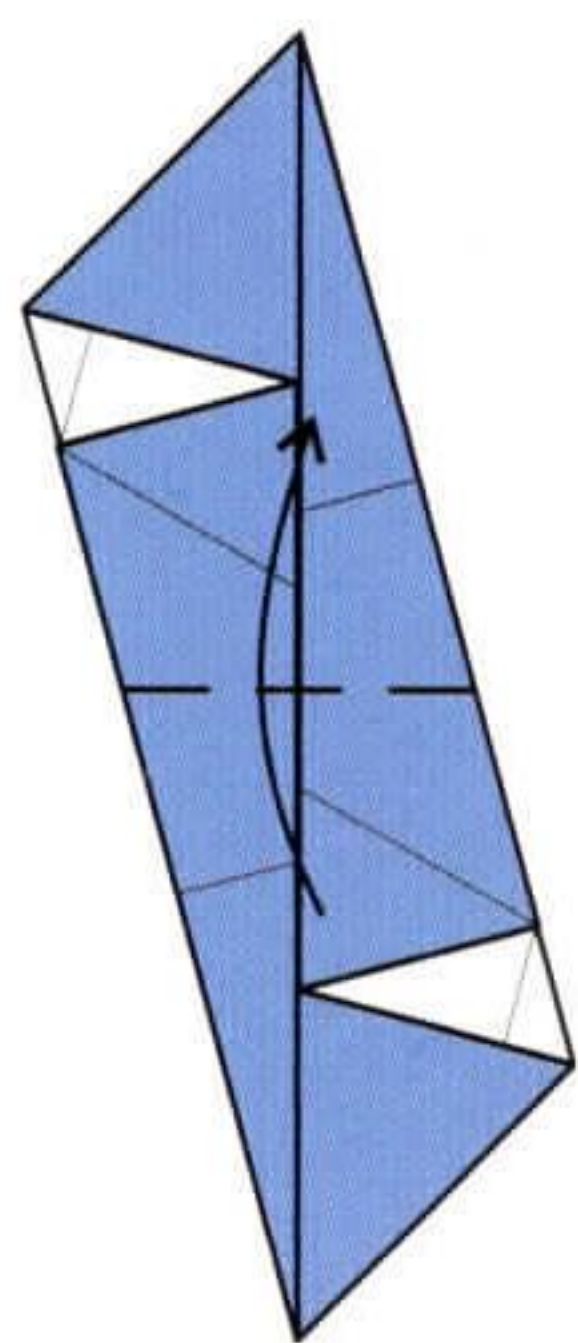

7 Fold the lower section up.

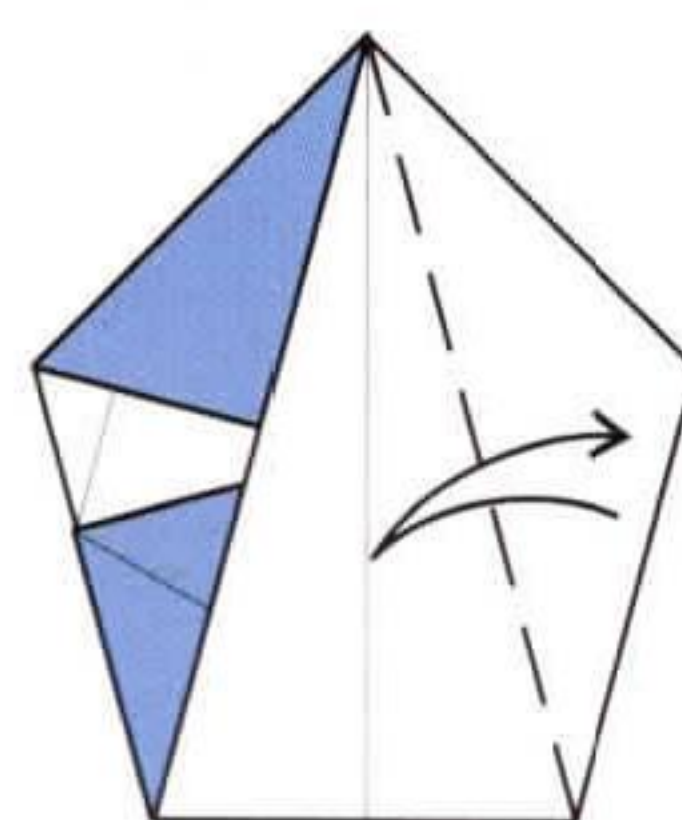

8 Fold and unfold the right side in.

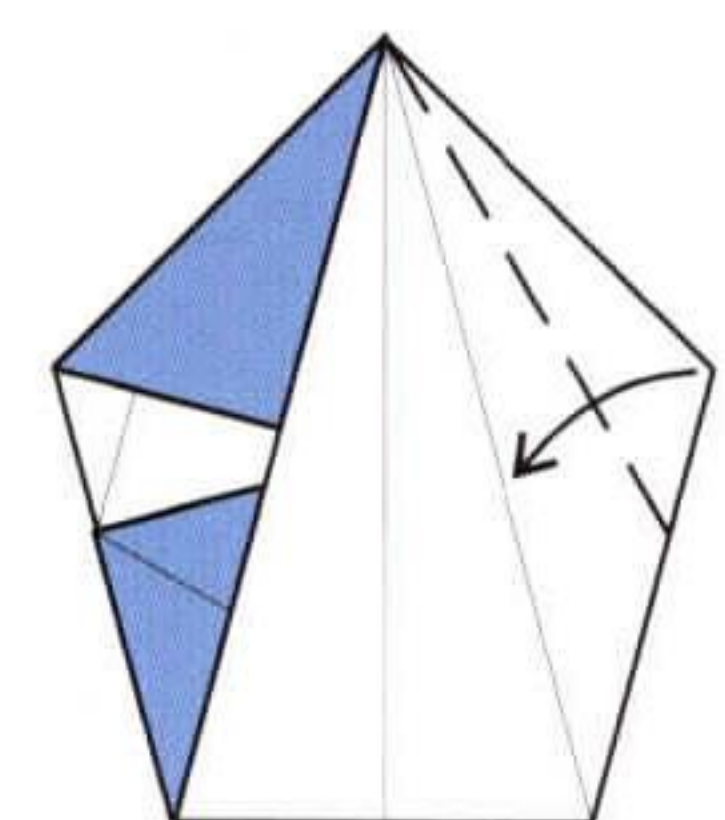

9 Fold the edge in to the crease made in step 8.

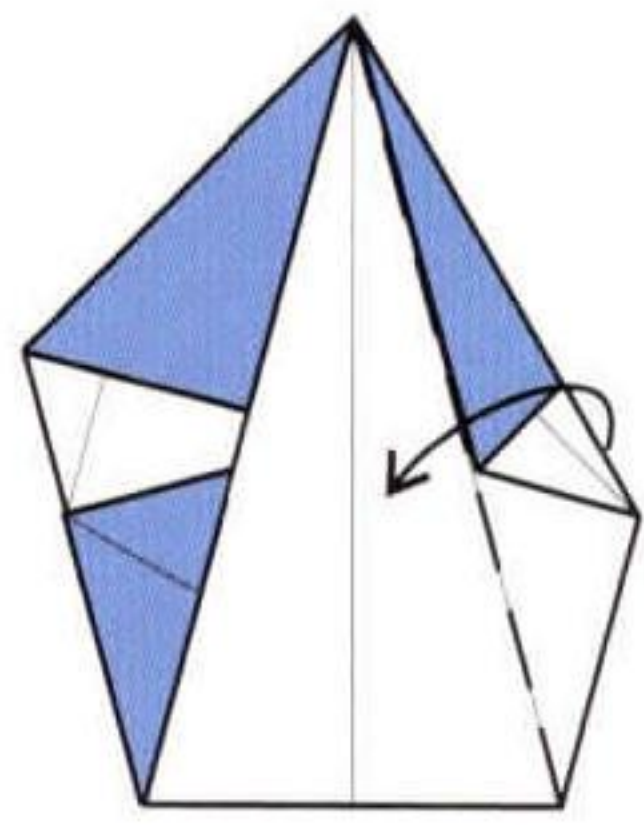

10 Fold the edge over again.

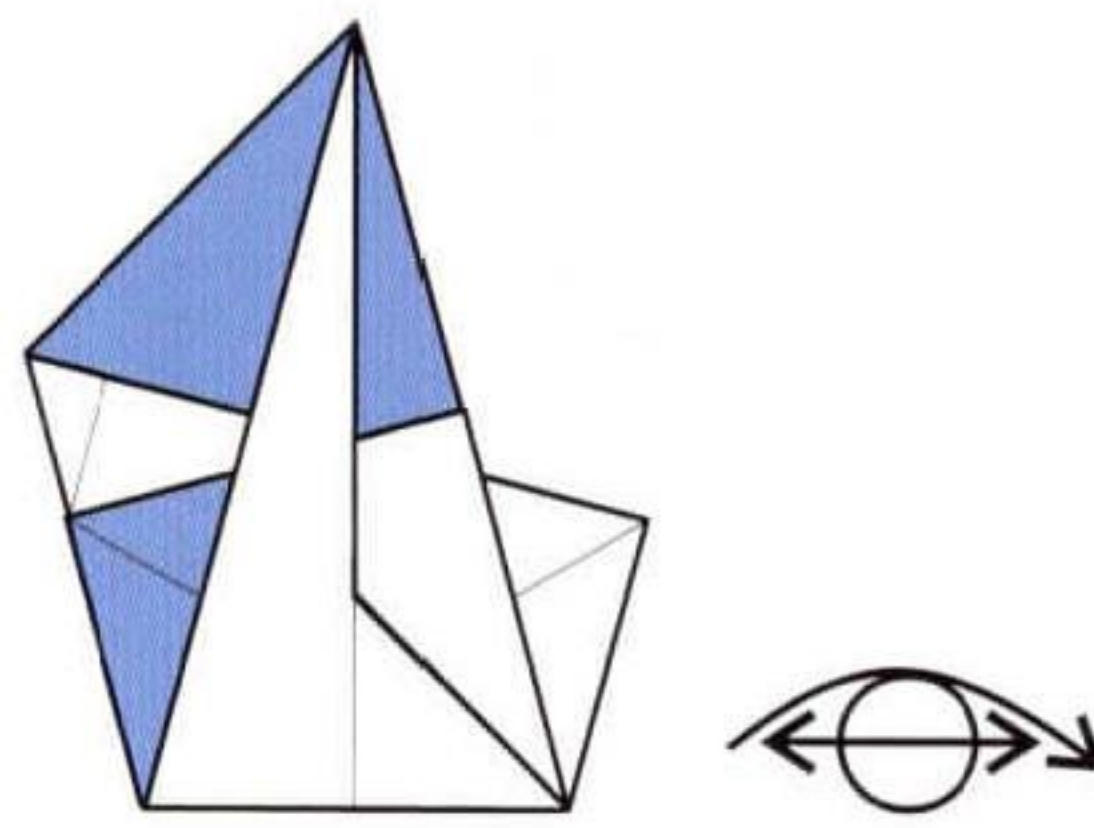

11 Turn the model over left to right.

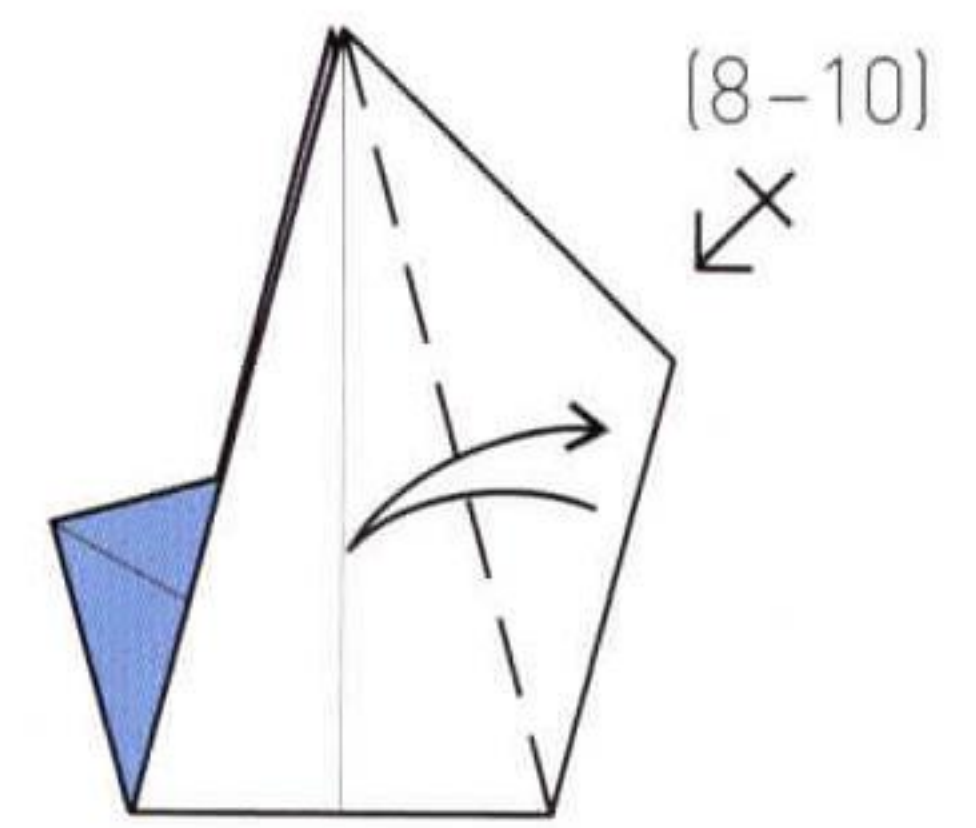

12 Repeat steps 8 to 10.

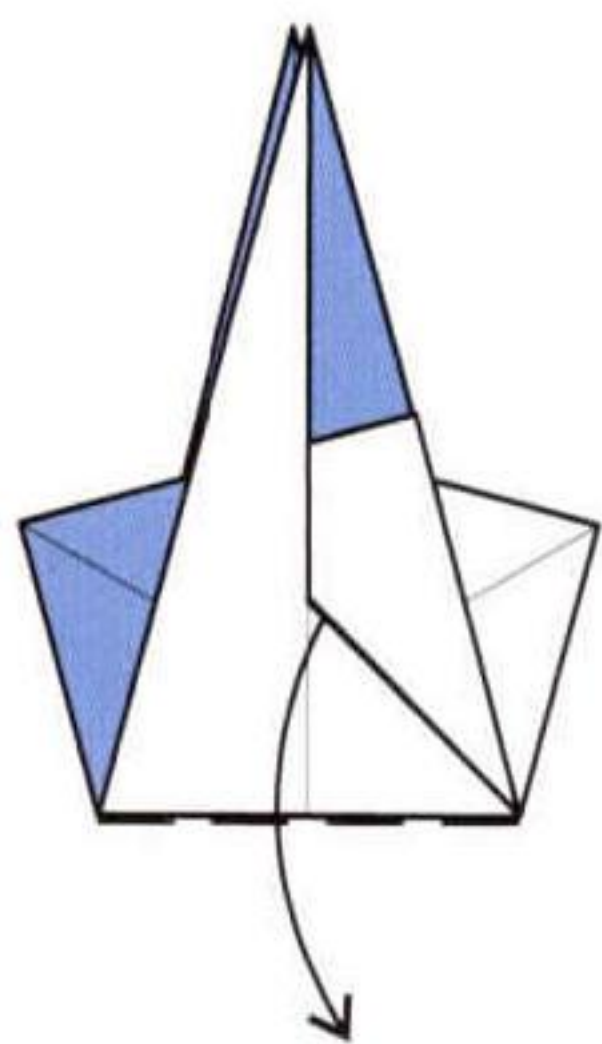

13 Fold the upper section down.

Front view Back view

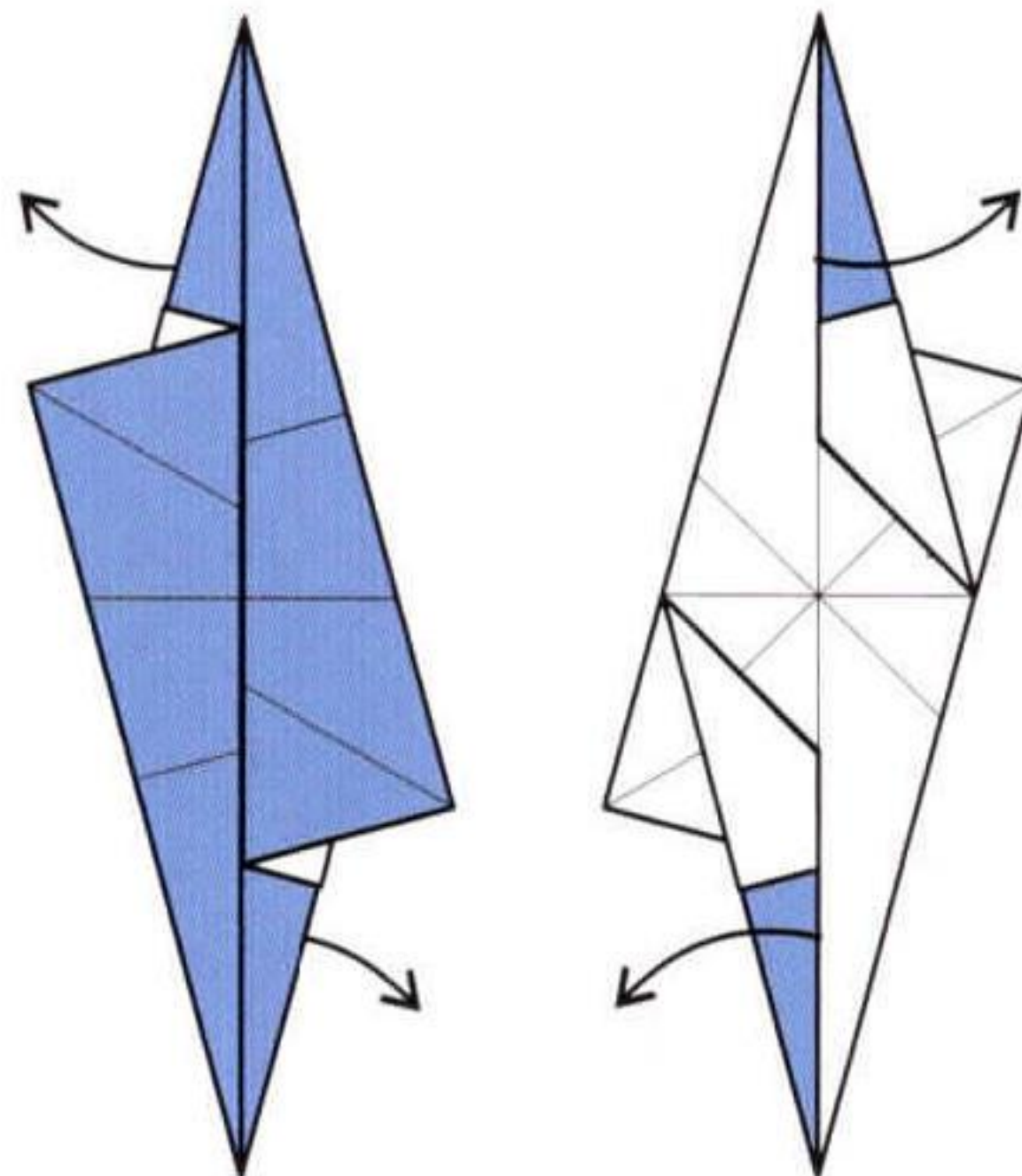

14 Unfold the corners on both sides (back to step 7).

Front view Back view

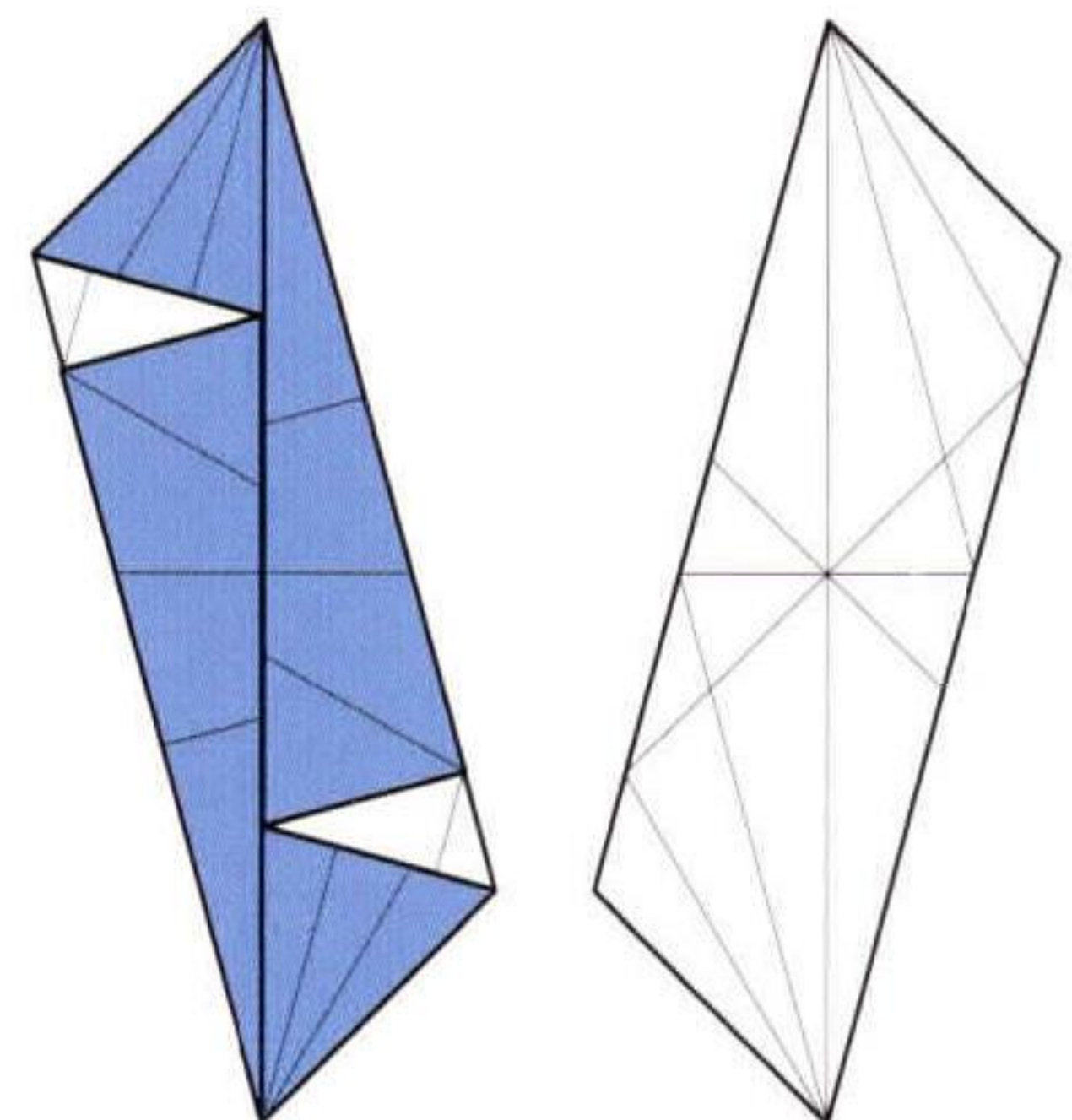

15 Unit complete.

LINKING TWO MODULES

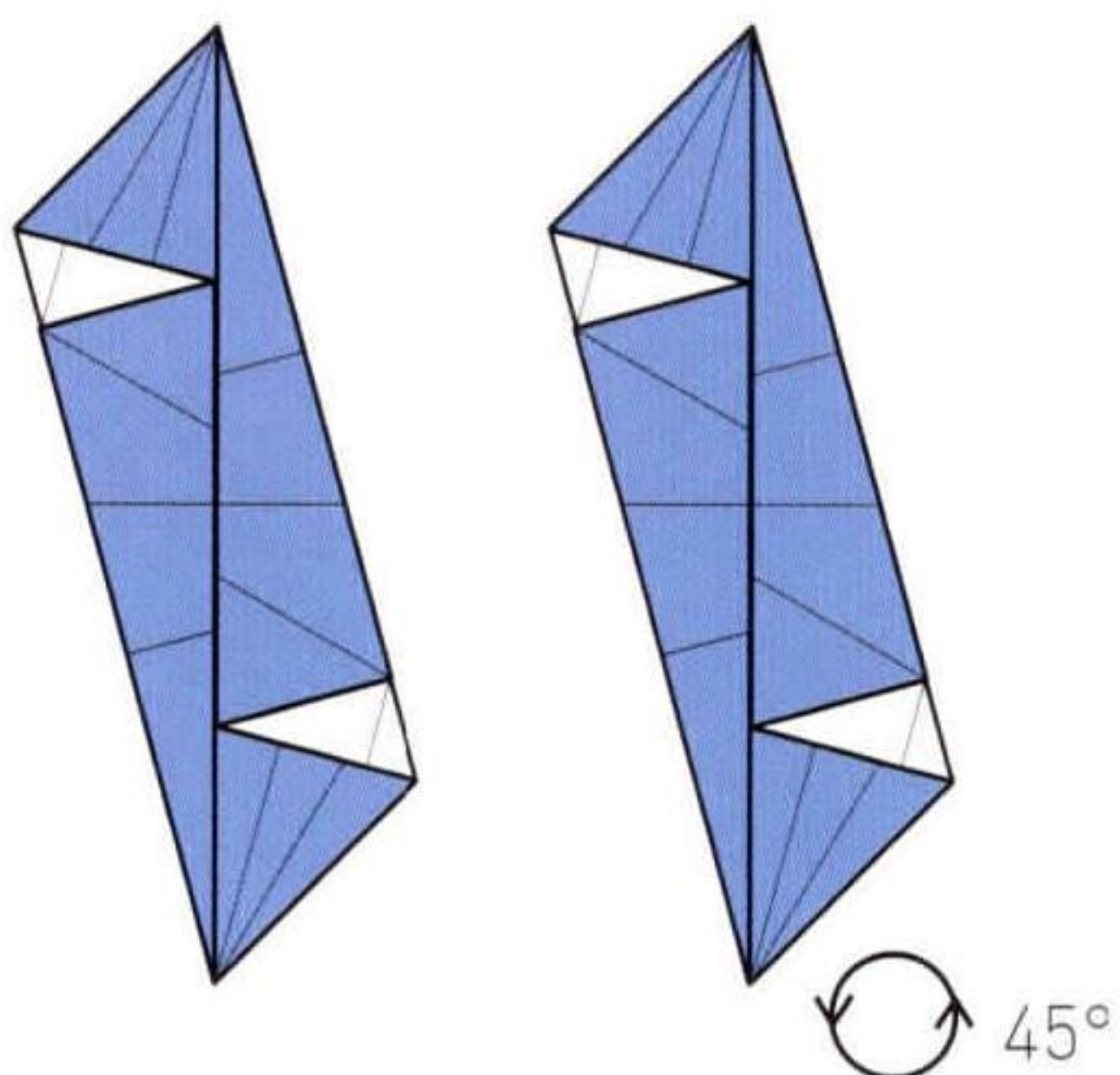

1 Start with two similar modules. Rotate one by 45°.

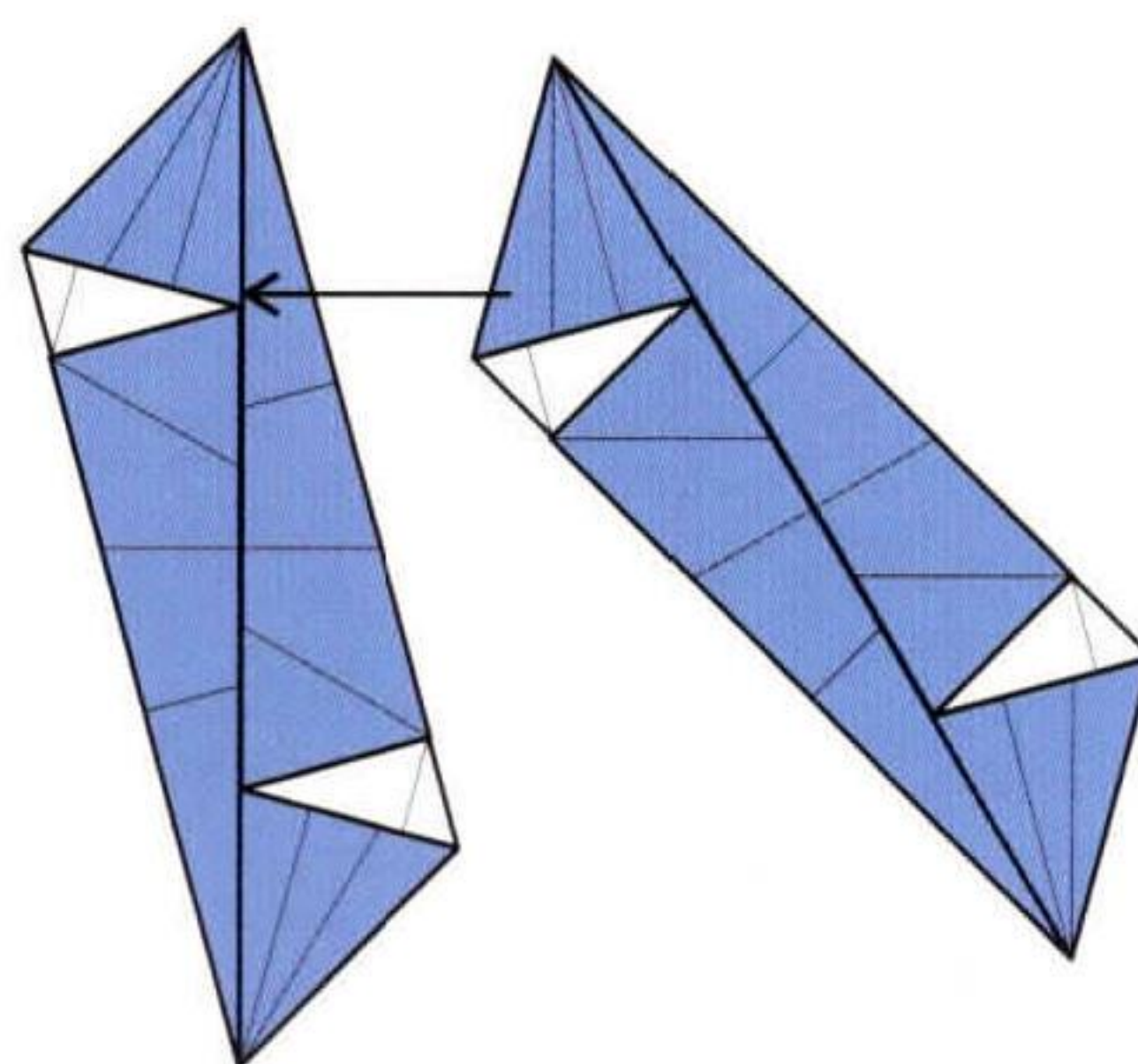

2 Move the tab from one module over the edge of the other.

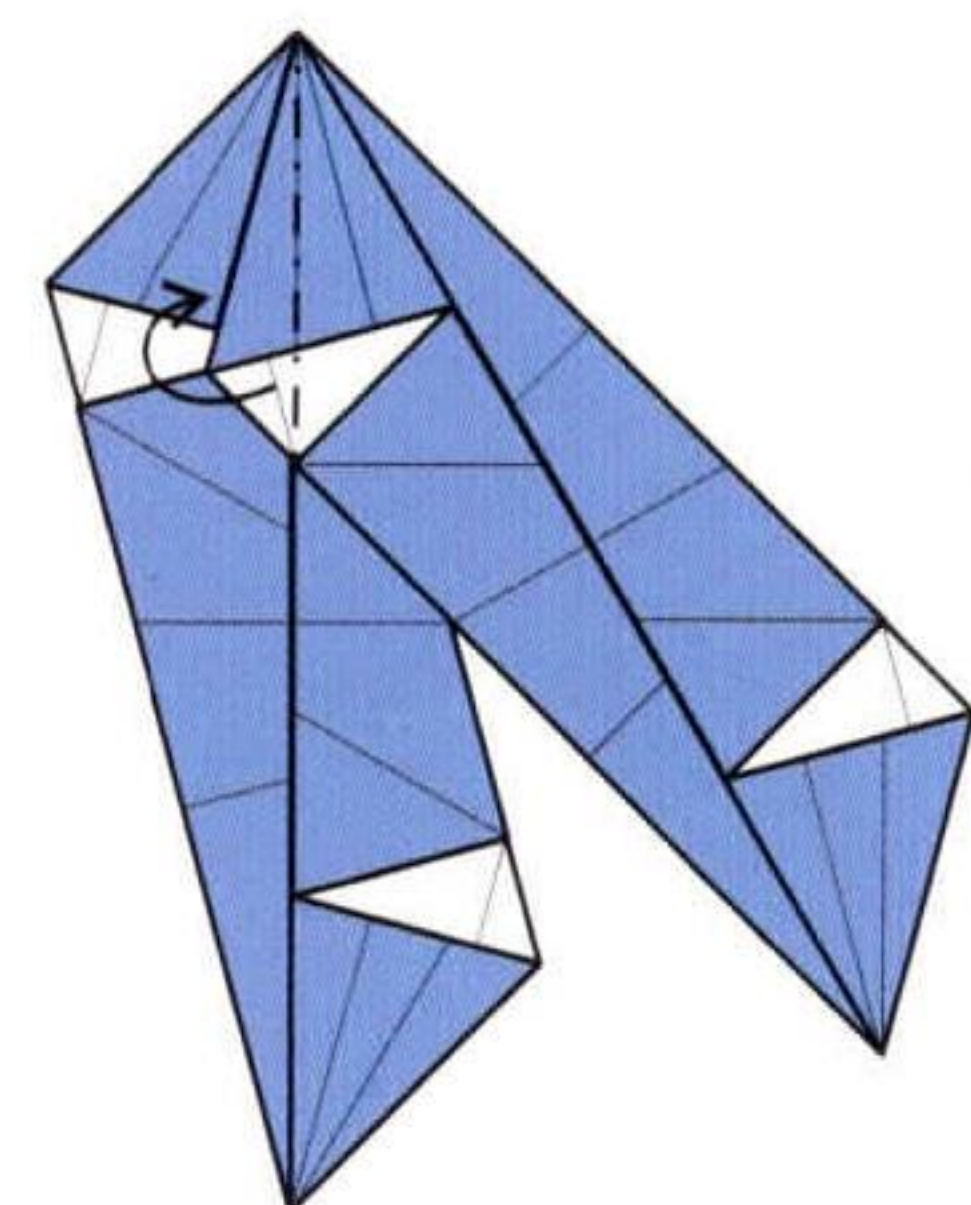

3 Fold the corner of the upper unit behind and into a pocket in the unit beneath, to link the two units.

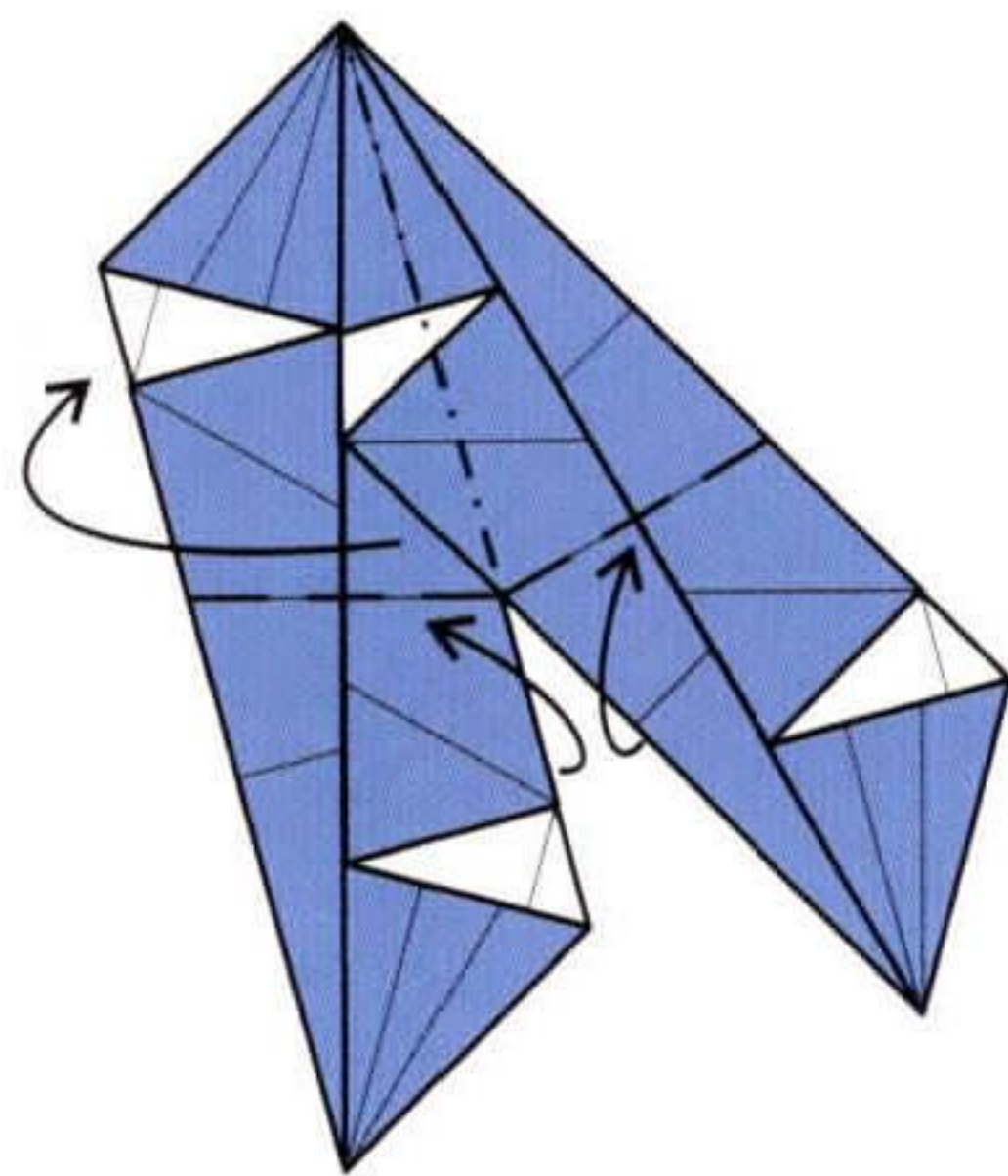

4 Fold the assembly in half at the edge where the two units meet.

This shows the two linked units as part of a five-unit assembly.

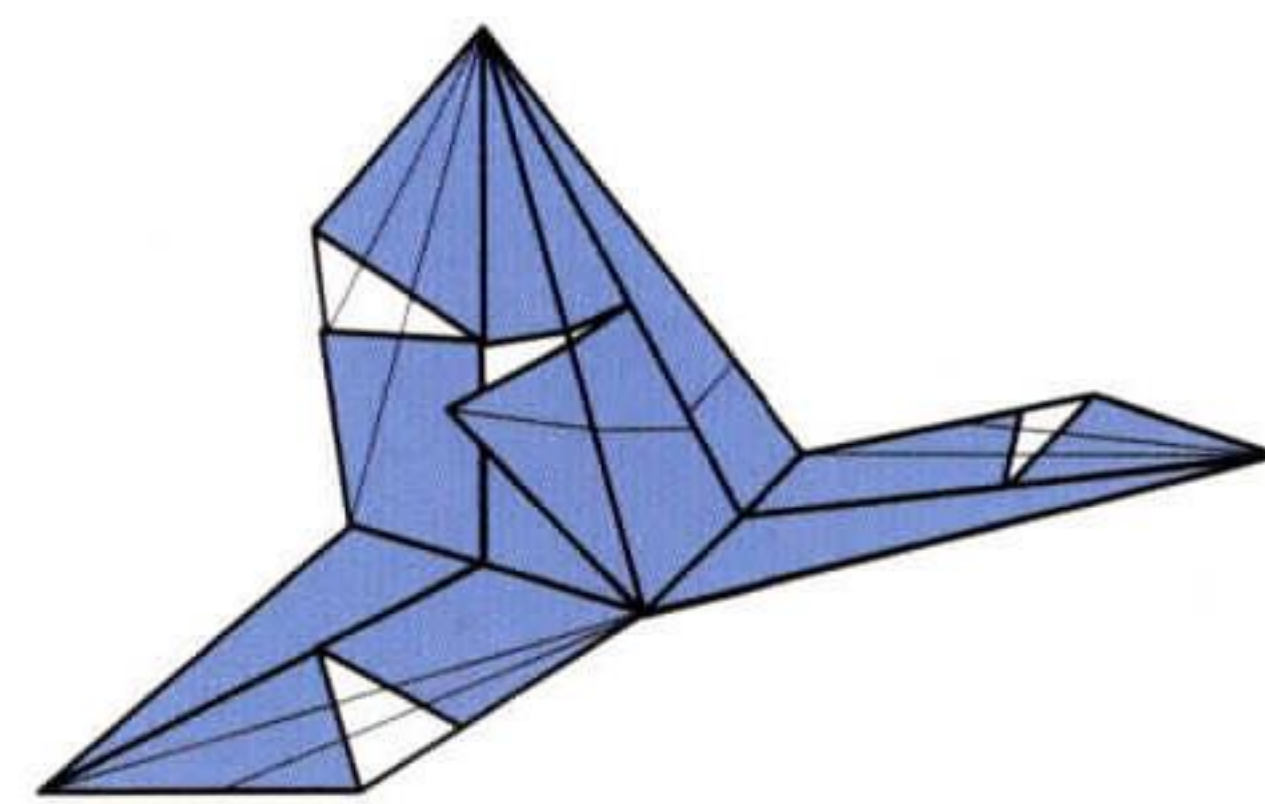
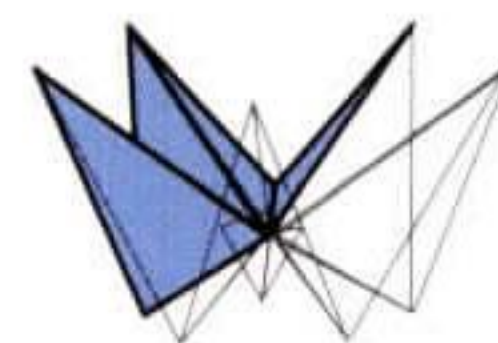

5 The two joined modules will look like this.

Three units as part of a five-unit assembly.

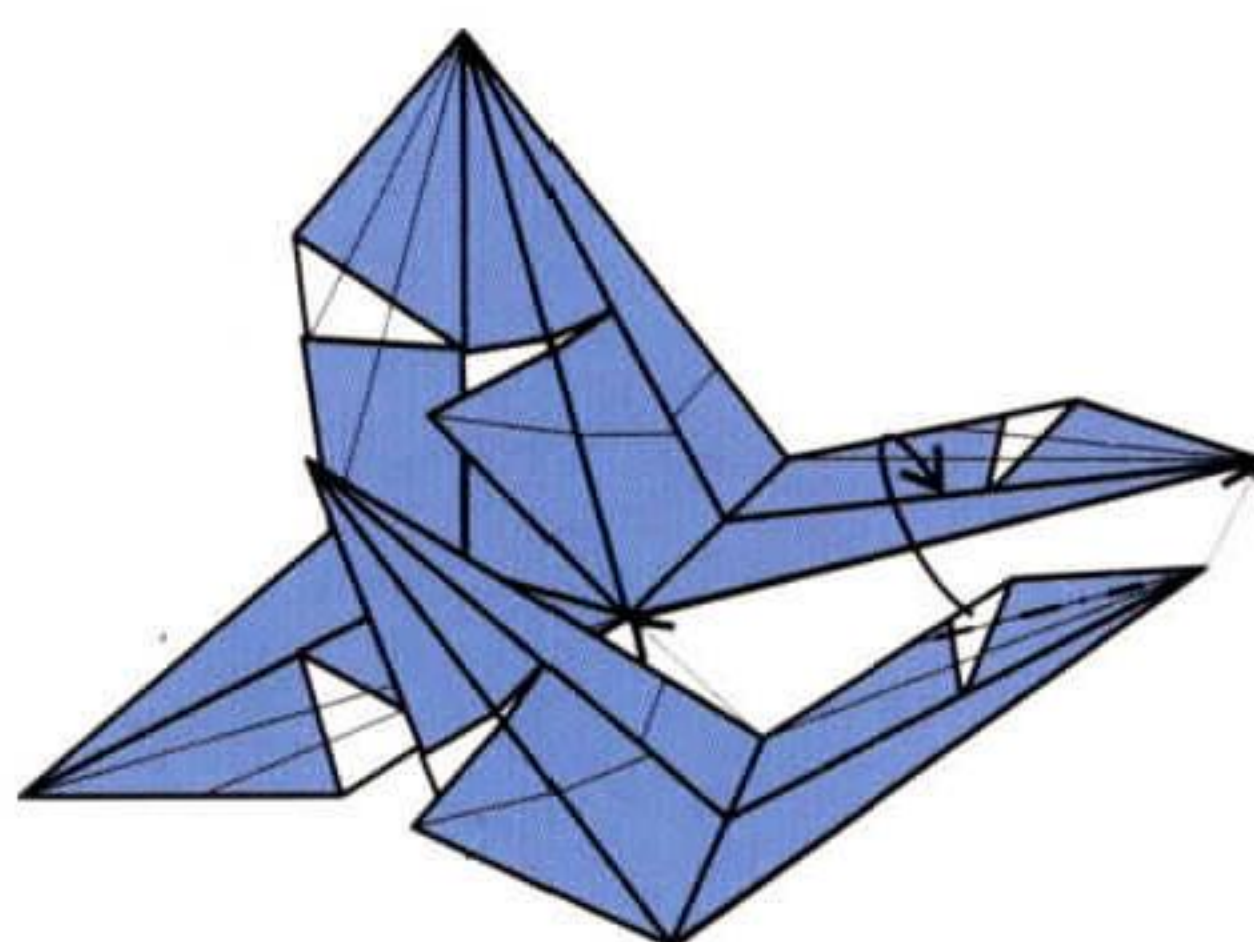
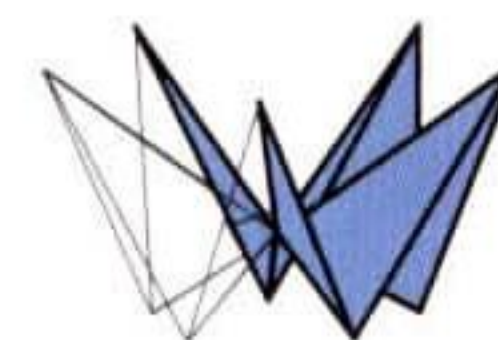

6 Add a third module. Repeat the linking process by tucking the corner of one unit into the pocket of the other.

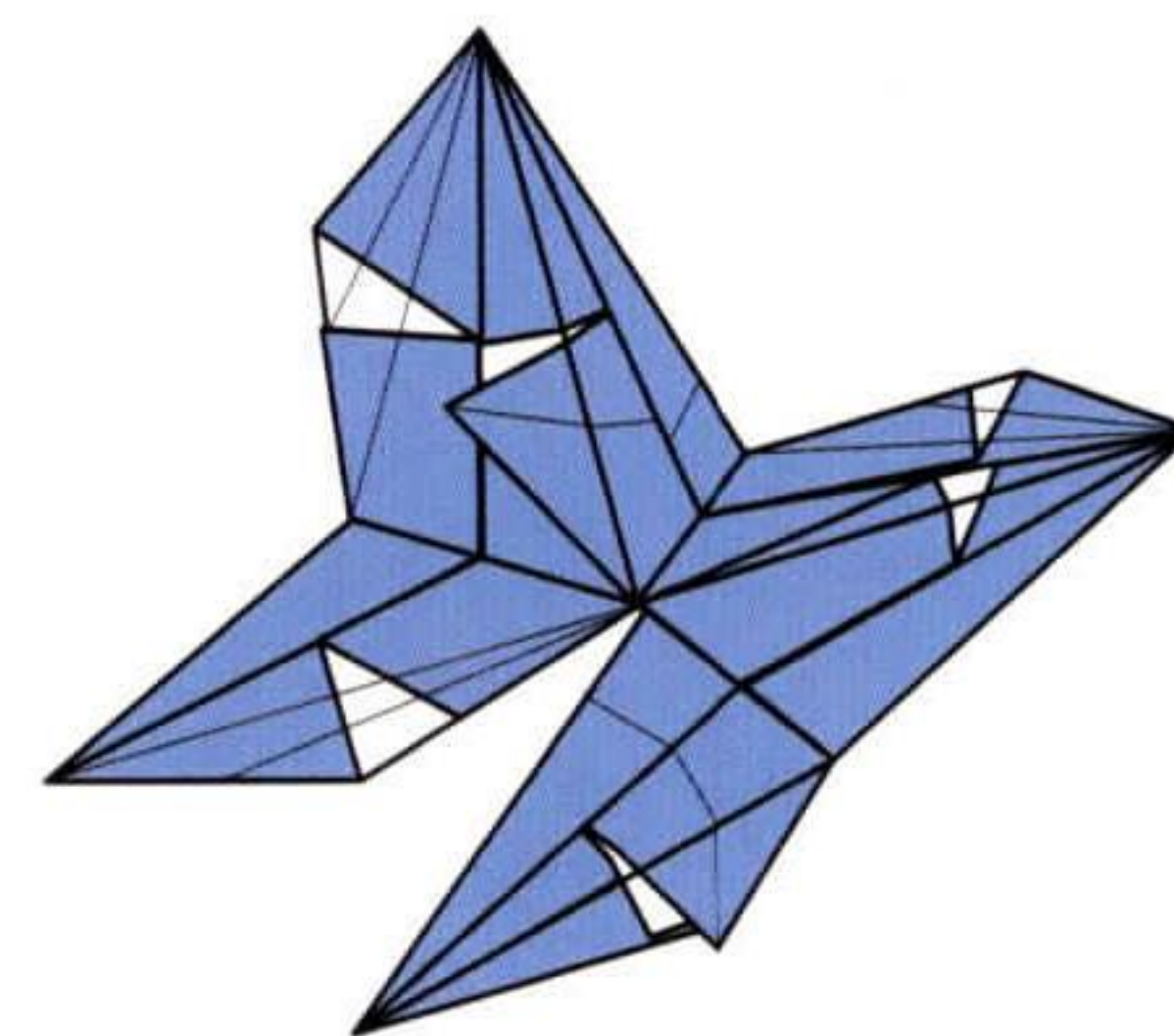

7 Three modules combined.

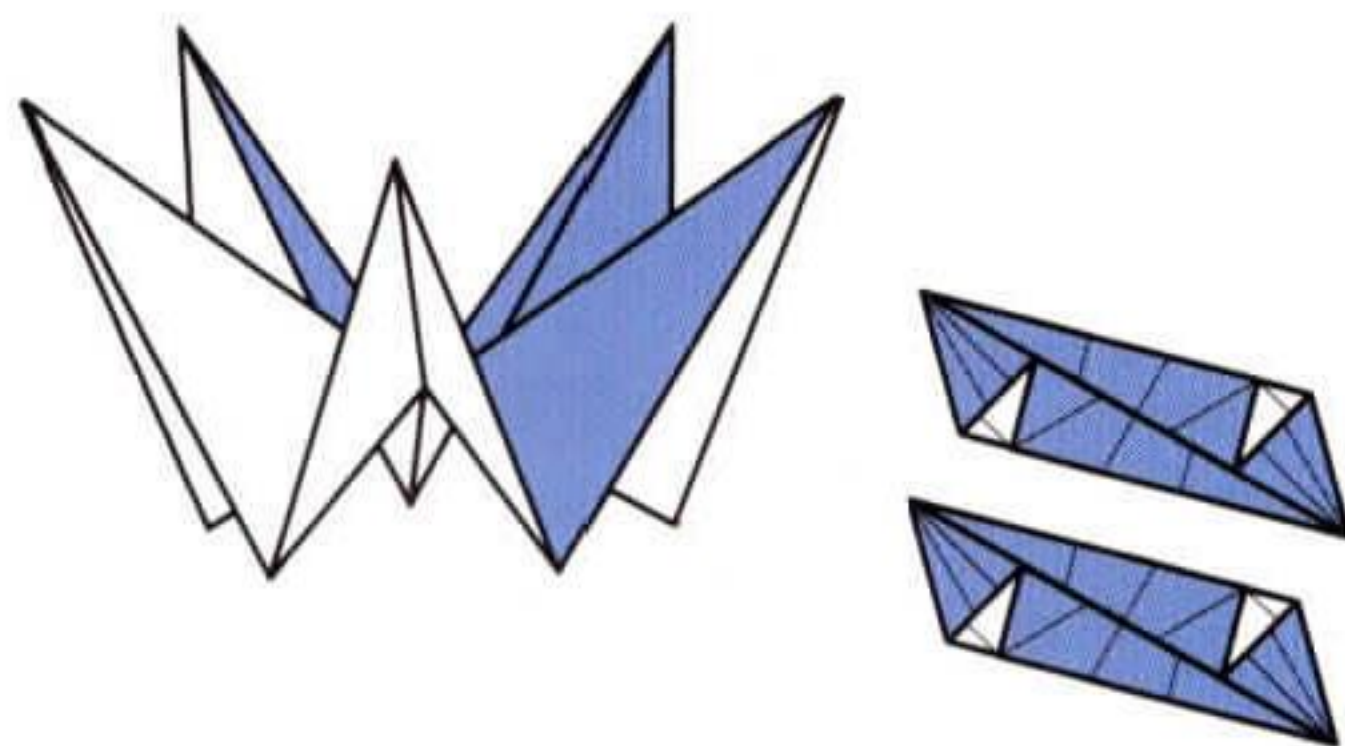

8 Working to join five modules together, we now need to add two more modules. Connect them in a similar way to the previously assembled units.

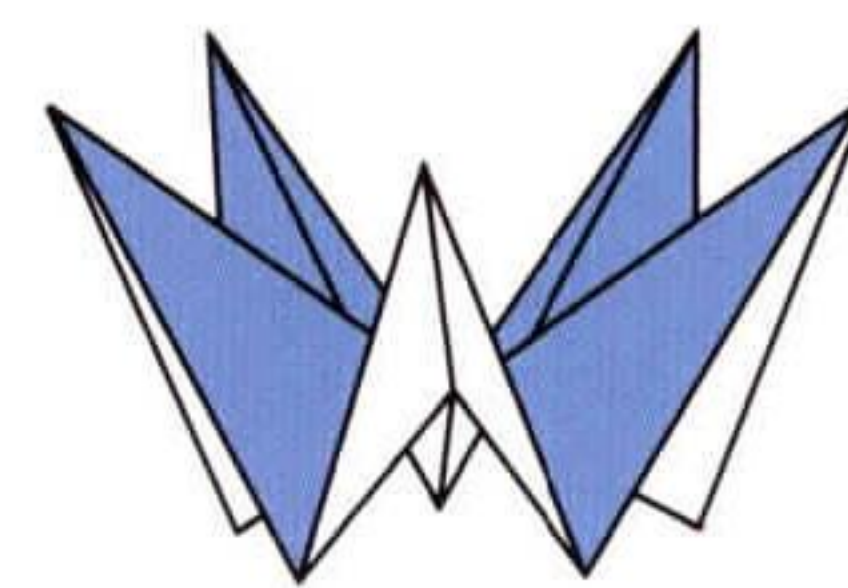

9 Five joined modules.

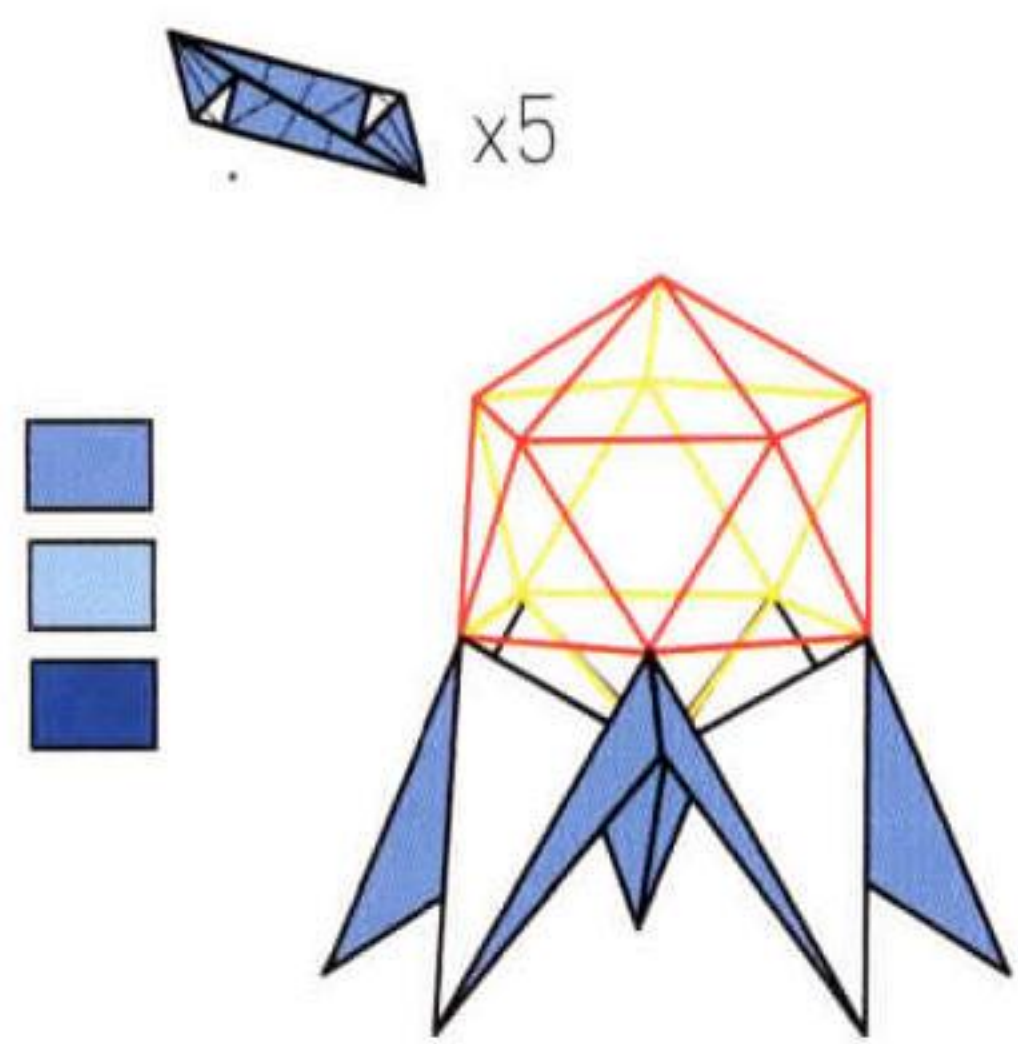

10 Start with five assembled units of a similar colour.

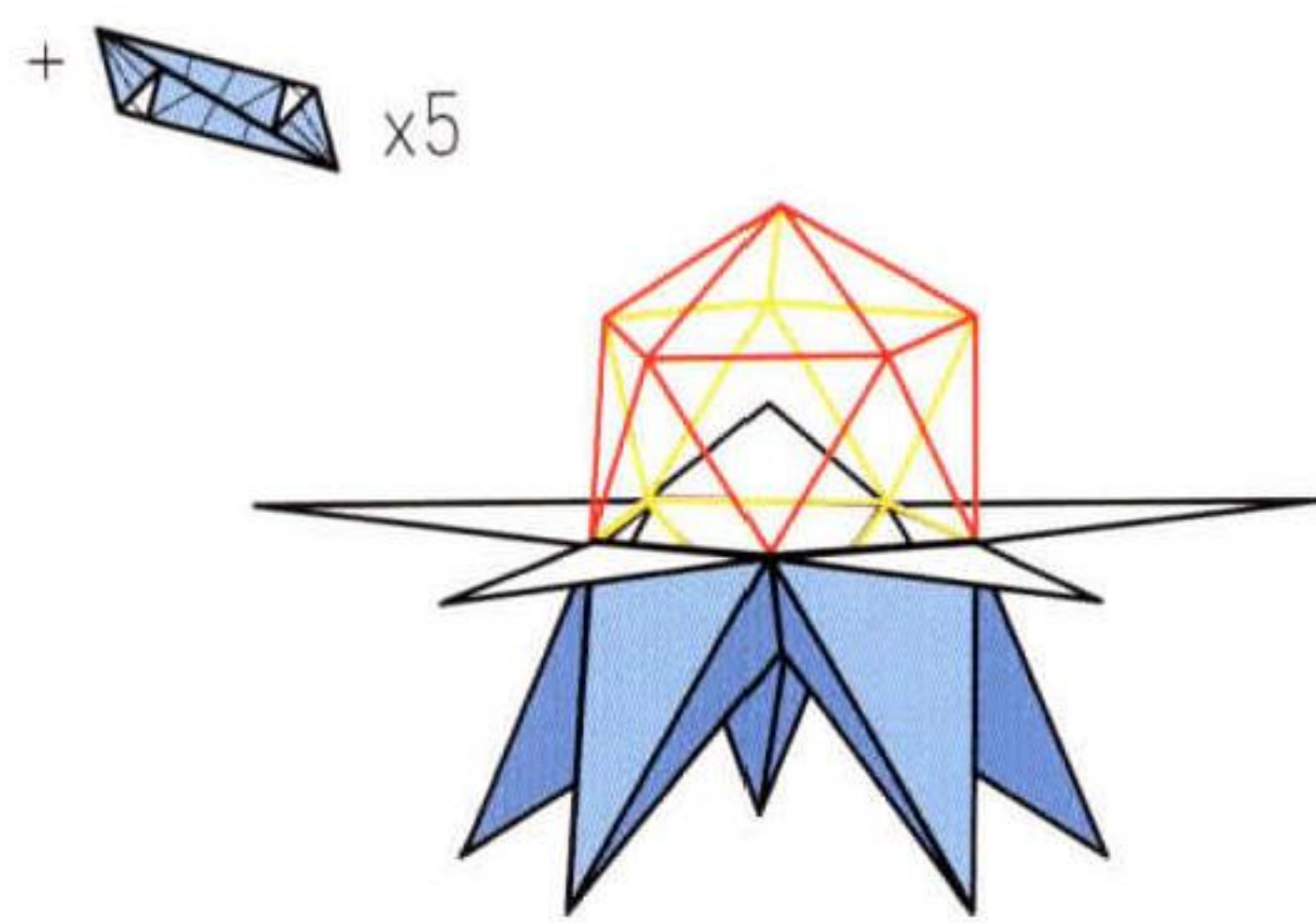

11 Add five more modules of another colour in between the modules that have been assembled previously.

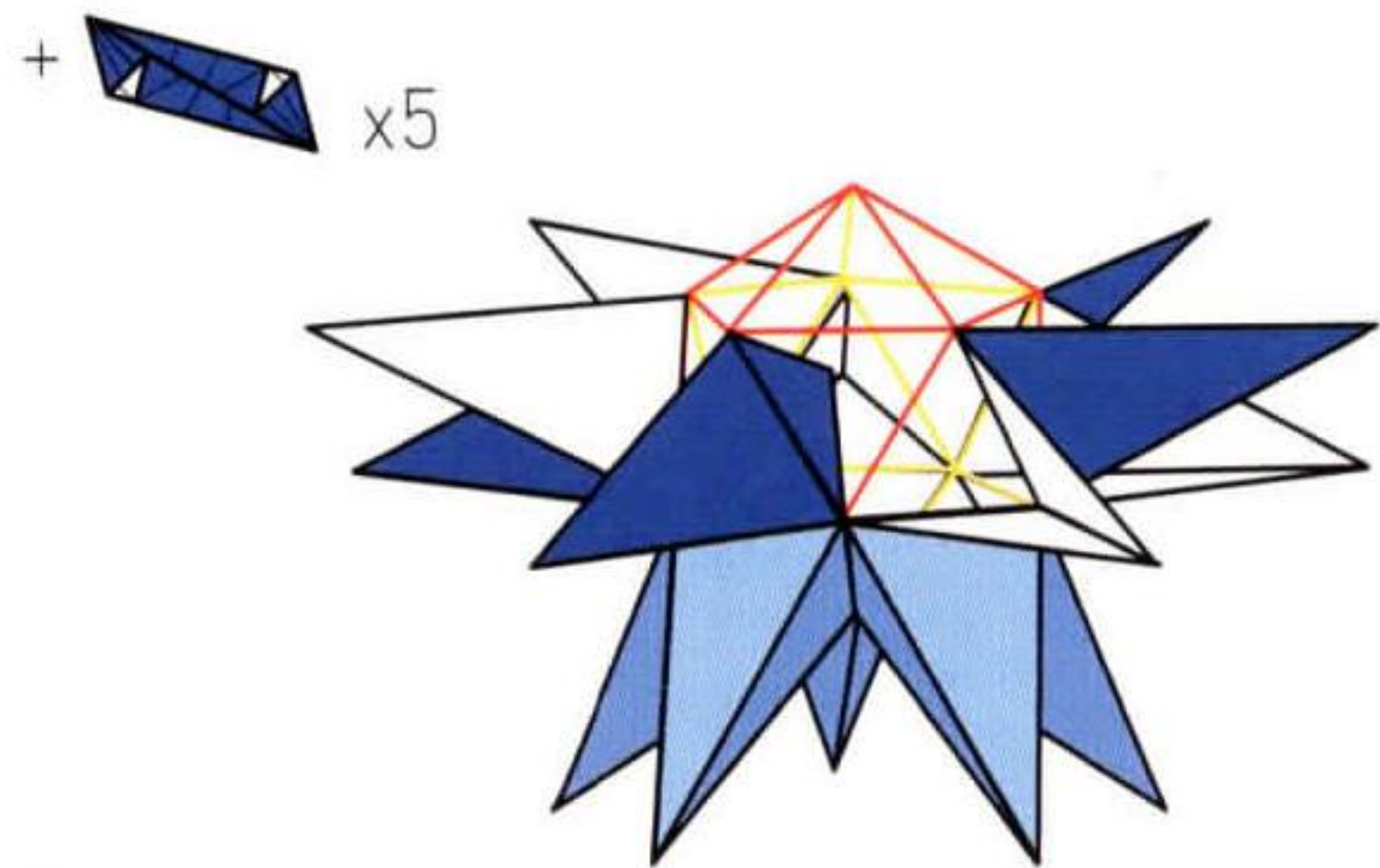

12 Add five more modules of a third colour. These modules are all added to the right of the upper edge of the assembly.

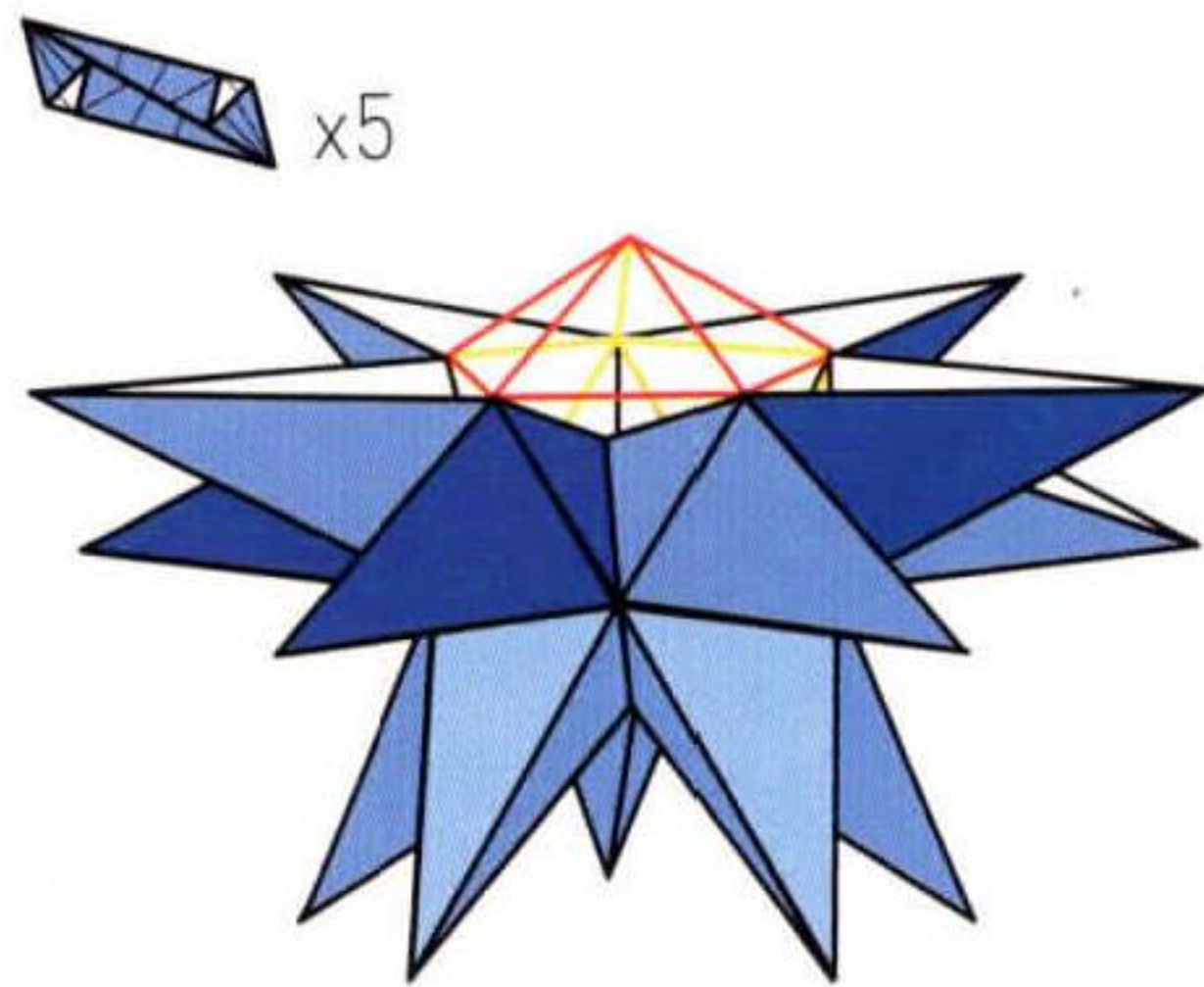

13 Add five more units.

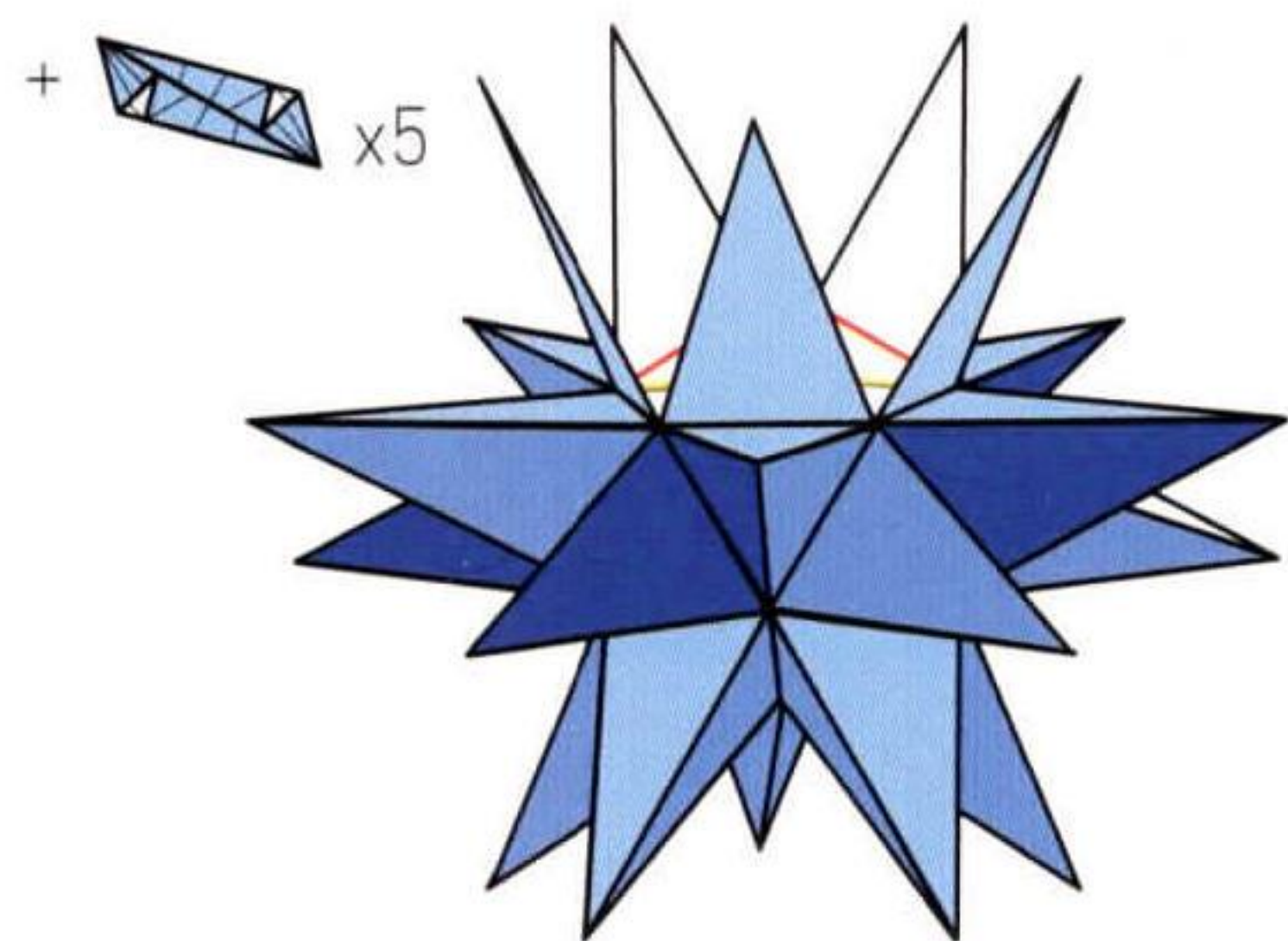

14 The next five units join up the units added in the previous two steps.

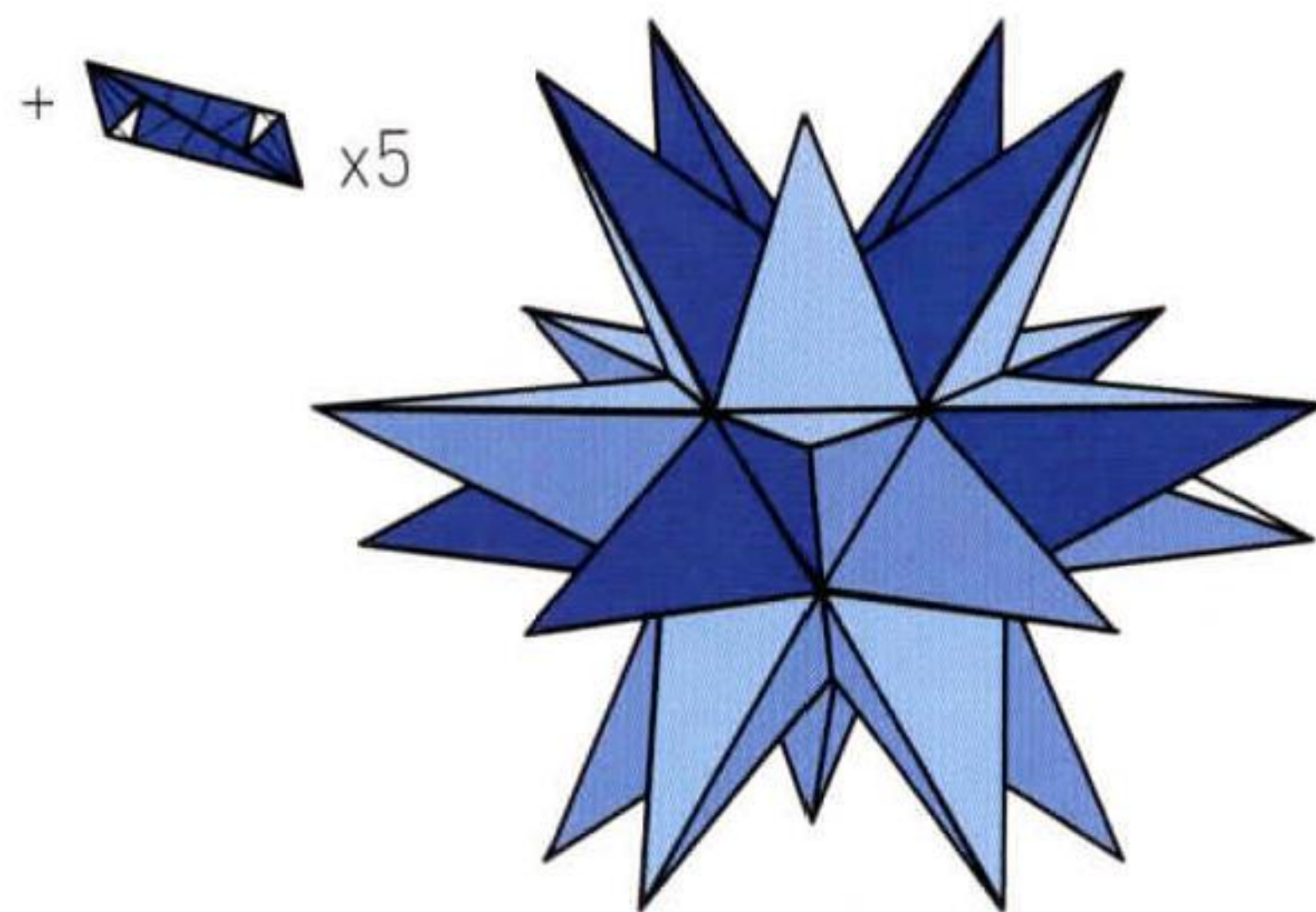

15 Complete. Other assemblies can be made from 3, 6 and 12 units.

